

TOSHIBA

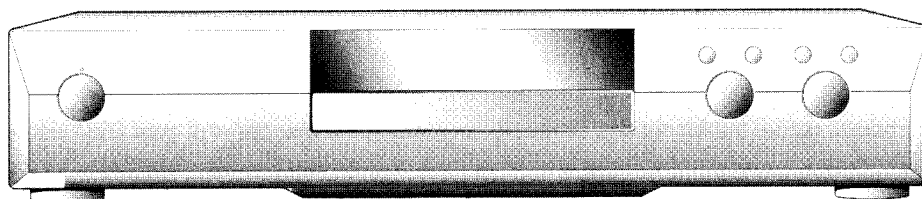

DVD VIDEO PLAYER **SD-1008**

OWNER'S MANUAL



Introduction

Connections

Basic Playback

Advanced Playback

Function Setup

Others

SAFETY PRECAUTIONS

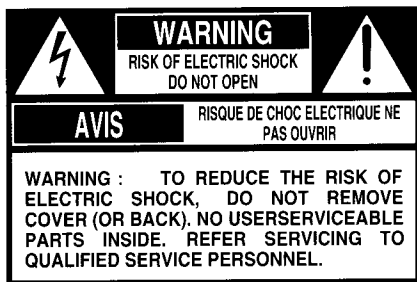

The lightning flash with arrowhead symbol, within an equilateral triangle, is intended to alert the user to the presence of uninsulated "dangerous voltage" within the product's enclosure that may be of sufficient magnitude to constitute a risk of electric shock to persons.

The exclamation point within an equilateral triangle is intended to alert the user to the presence of important operating and maintenance (servicing) instructions in the literature accompanying the appliance.

WARNING: TO REDUCE THE RISK OF FIRE OR ELECTRIC SHOCK, DO NOT EXPOSE THIS APPLIANCE TO RAIN OR MOISTURE. DANGEROUS HIGH VOLTAGES ARE PRESENT INSIDE THE ENCLOSURE. DO NOT OPEN THE CABINET. REFER SERVICING TO QUALIFIED PERSONNEL ONLY.

CAUTION: TO PREVENT ELECTRIC SHOCK, MATCH WIDE BLADE OF PLUG TO WIDE SLOT, FULLY INSERT.

ATTENTION: POUR EVITER LES CHOC ELECTRIQUE, INTRODUIRE LA LAME LA PLUS LARGE DE LA FICHE DANS LA BORNE CORRESPONDANTE DE LA PRISE ET POUSSER JUSQU' AU FOND.

CAUTION: This Digital Video Disc Player employs a Laser System. To ensure proper use of this product, please read this owner's manual carefully and retain for future reference. Should the unit require maintenance, contact an authorized service location - see service procedure.

Use of controls, adjustments or the performance of procedures other than those specified may result herein hazardous radiation exposure.

To prevent direct exposure to laser beam, do not try to open the enclosure. Visible laser radiation when open and interlocks defeated. DO NOT STARE INTO BEAM.

FCC NOTICE: This equipment has been tested and found to comply with the limits for a Class B digital device, pursuant to part 15 of the FCC Rule. These limits are designed to provide reasonable protection against harmful interference in a residential installation. This equipment generates, uses, and can radiate radio frequency energy and, if not installed and used in accordance with the instructions, may cause harmful interference to radio communications. However, there is no guarantee that interference will not occur in a particular installation. If this equipment does cause harmful interference to radio or television reception, which can be determined by turning the equipment off and on, the user is encouraged to try to correct the interference by one or more of the following measures:

- Reorient or relocate the receiving antenna.
- Increase the separation between the equipment and receiver.
- Connect the equipment into an outlet on a circuit different from that to which the receiver is connected.
- Consult the dealer or an experienced radio/TV technician for help.

WARNING: Changes or modifications made to this equipment, not expressly approved by Toshiba, or parties authorized by Toshiba, could void the user's authority to operate the equipment.

In the spaces provided below, record the Model and Serial No. located on the rear panel of your DVD video player.

Model No. _____

Serial No. _____

Retain this information for future reference.

Location of the required label

PRODUCT IS CERTIFIED BY THE MANUFACTURER TO COMPLY WITH DHHS RULES 21 CFR SUBCHAPTER J APPLICABLE AT THE DATE OF MANUFACTURE.

MANUFACTURED

TOSHIBA AMERICA CONSUMER PRODUCTS, INC.
82 TOTOWA RD., WAYNE, NJ 07470, U.S.A

or

PRODUCT IS CERTIFIED BY THE MANUFACTURER TO COMPLY WITH DHHS RULES 21 CFR SUBCHAPTER J APPLICABLE AT THE DATE OF MANUFACTURE.

MANUFACTURED

TOSHIBA OF CANADA, LTD.
191 McNABB ST., MARKHAM, ONTARIO,
L3R 8H2, CANADA

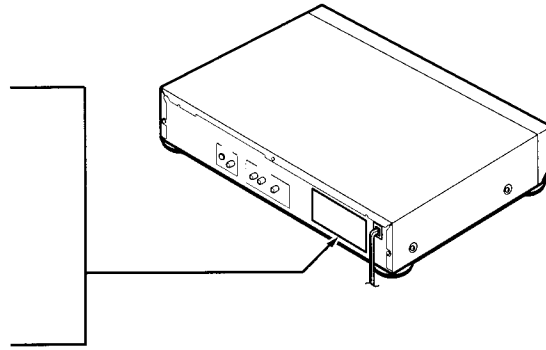

Introduction

IMPORTANT SAFETY INSTRUCTIONS

CAUTION: PLEASE READ AND OBSERVE ALL WARNINGS AND INSTRUCTIONS GIVEN IN THIS OWNER'S MANUAL AND THOSE MARKED ON THE UNIT. RETAIN THIS BOOKLET FOR FUTURE REFERENCE.

This set has been designed and manufactured to assure personal safety. Improper use can result in electric shock or fire hazard. The safeguards incorporated in this unit will protect you if you observe the following procedures for installation, use and servicing. This unit is fully transistorized and does not contain any parts that can be repaired by the user.

DO NOT REMOVE THE CABINET COVER, OR YOU MAY BE EXPOSED TO DANGEROUS VOLTAGE. REFER SERVICING TO QUALIFIED SERVICE PERSONNEL ONLY.

1. Read owner's manual

After unpacking this product, read the owner's manual carefully, and follow all the operating and other instructions.

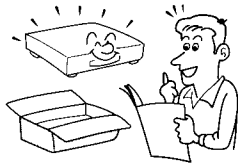

2. Power Sources

This product should be operated only from the type of power source indicated on the marking label. If you are not sure of the type of power supply to your home, consult your product dealer or local power company. For products intended to operate from battery power, or other sources, refer to the operating instructions.



3. Grounding or Polarization

This product may be equipped with a polarized alternating current line plug (a plug having one blade wider than the other). This plug will fit into the power outlet only one way. This is a safety feature. If you are unable to insert the plug fully into the outlet, try reversing the plug. If the plug should still fail to fit, contact your electrician to replace your obsolete outlet. Do not defeat the safety purpose of the polarized plug.

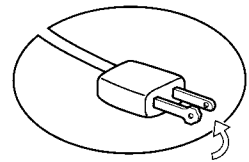

4. Ventilation

Slots and openings in the cabinet are provided for ventilation and to ensure reliable operation of the product and to protect it from overheating, and these openings must not be blocked or covered. The openings should never be blocked by placing the product on a bed, sofa, rug or other similar surface. This product should not be placed in a built-in installation such as a bookcase or rack unless proper ventilation is provided or the manufacturer's instructions have been adhered to.

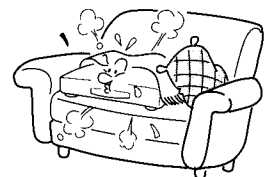

IMPORTANT SAFETY INSTRUCTIONS

5. Heat

The product should be situated away from heat sources such as radiators, heat registers, stoves, or other products (including amplifiers) that produce heat.

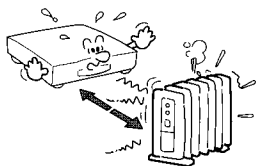

6. Water and Moisture

Do not use this product near water - for example, near a bath tub, wash bowl, kitchen sink, or laundry tub; in a wet basement; or near a swimming pool and the like.

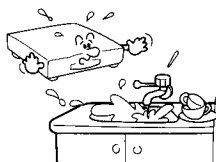

7. Cleaning

Unplug this product from the wall outlet before cleaning. Do not use liquid cleaners or aerosol cleaners. Use a damp cloth for cleaning.



8. Power-Cord Protection

Power-supply cords should be routed so that they are not likely to be walked on or pinched by items placed upon or against them, paying particular attention to cords at plugs, convenience receptacles, and the point where they exit from the product.



9. Overloading

Do not overload wall outlets; extension cords, or integral convenience receptacles as this can result in a risk of fire or electric shock.

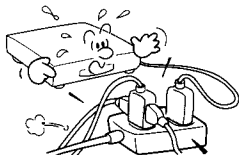

10. Lightning

For added protection for this product during storm, or when it is left unattended and unused for long periods of time, unplug it from the wall outlet. This will prevent damage to the product due to lightning and power-line surges.



11. Object and Liquid Entry

Never push objects of any kind into this product through openings as they may touch dangerous voltage points or short-out parts that could result in a fire or electric shock. Never spill liquid of any kind on the product.

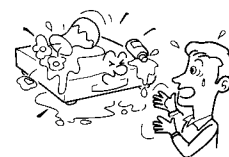

12. Attachments

Do not use attachments not recommended by the product manufacturer as they may cause hazards.

13. Accessories

Do not place this product on an unstable cart, stand, tripod, bracket, or table. The product may fall, causing serious injury to a child or adult, and serious damage to the product. Use only with a cart, stand, tripod, bracket, or table recommended by the manufacturer, or sold with the product.



Any mounting of the product should follow the manufacturer's instructions, and should use a mounting accessory recommended by the manufacturer.

A product and cart combination should be moved with care. Quick stops, excessive force, and uneven surfaces may cause the product and cart combination to overturn.

14. Disc Tray

Keep your fingers well clear of the disc tray as it is closing. Neglecting to may cause serious personal injury.

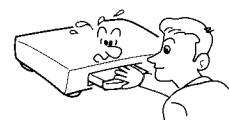

15. Burden

Do not place a heavy object on or step on the product. The object may fall, causing serious personal injury and serious damage to the product.

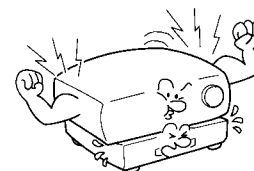

16. Headphones

When you use headphones, keep the volume at a moderate level. If you use the headphones continuously with high volume sound, it may cause hearing damage.



21. Safety Check

Upon completion of any service or repairs to this product, ask the service technician to perform safety checks to determine that the product is in proper operating condition.

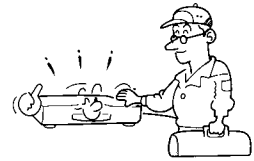

17. Disc

Do not use a cracked, deformed, or repaired disc. These discs are easily broken and may cause serious personal injury and product malfunction.

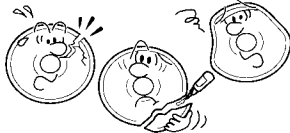

18. Damage Requiring Service

Unplug this product from the wall outlet and refer servicing to qualified service personnel under the following conditions:

- When the power-supply cord or plug is damaged.
- If liquid has been spilled, or objects have fallen into the product.
- If the product has been exposed to rain or water.
- If the product does not operate normally by following the operating instructions. Adjust only those controls that are covered by the operating instructions as an improper adjustment of other controls may result in damage and will often require extensive work by a qualified technician to restore the product to its normal operation.
- If the product has been dropped or damaged in any way.
- When the product exhibits a distinct change in performance - this indicates a need for service.

19. Servicing

Do not attempt to service this product yourself as opening or removing covers may expose you to dangerous voltage or other hazards. Refer all servicing to qualified service personnel.

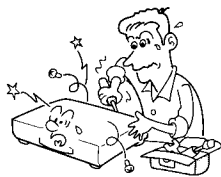

20. Replacement Parts

When replacement parts are required, be sure the service technician has used replacement parts specified by the manufacturer or have the same characteristics as the original part. Unauthorized substitutions may result in fire, electric shock, or other hazards.

Precautions

Notes on Handling

- When shipping the DVD video player, the original shipping carton and packing materials come in handy. For maximum protection, repack the unit as it was originally packed at the factory.
- Do not use volatile liquids, such as insect spray, near the DVD video player. Do not leave rubber or plastic products in contact with the DVD video player for a long time. They will leave marks on the finish.
- The top and rear panels of the DVD video player may become warm after a long period of use. This is not a malfunction.
- When the DVD video player is not in use, be sure to remove the disc and turn off the power.
- If you do not use the DVD video player for a long period, the unit may not function properly in the future. Turn on and use the DVD video player occasionally.

Notes on Locating

- When you place this DVD video player near a TV, radio, or VCR, the playback picture may become poor and the sound may be distorted. In this case, place the DVD video player away from the TV, radio, or VCR.

Notes on Cleaning

Use a soft, dry cloth for cleaning.

- For stubborn dirt, soak the cloth in a weak detergent solution, wring well and wipe. Use a dry cloth to wipe it dry. Do not use any type of solvent, such as thinner and benzene, as they may damage the surface of the DVD video player.
- If you use a chemical saturated cloth to clean the unit, follow that product's instructions.

To Obtain a Clear Picture

The DVD video player is a high technology, precision device. If the optical pick-up lens and disc drive parts are dirty or worn down, the picture quality becomes poor. To obtain a clear picture, we recommend regular inspection and maintenance (cleaning or parts replacement) every 1,000 hours of use depending on the operating environment. For details, contact your nearest dealer.

Notes on Moisture Condensation

Moisture condensation damages the DVD video player. Please read the following carefully.

Moisture condensation occurs, for example, when you pour a cold drink into a glass on a warm day. Drops of water form on the outside of the glass. In the same way, moisture may condense on the optical pick-up lens inside this unit, one of the most crucial internal parts of the DVD video player.

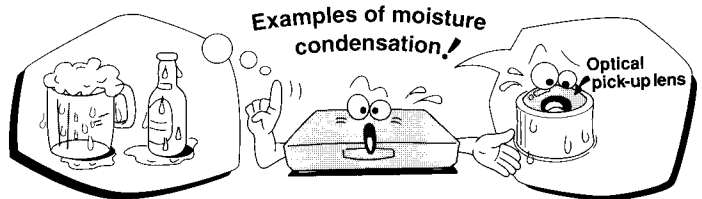

■ **Moisture condensation occurs during the following cases.**

- When you bring the DVD video player directly from a cold place to a warm place.
- When you use the DVD video player in a room where you just turned on the heater, or a place where the cold wind from the air conditioner directly hits the unit.
- In summer, when you use the DVD video player in a hot and humid place just after you move the unit from an air conditioned room.
- When you use the DVD video player in a humid place.

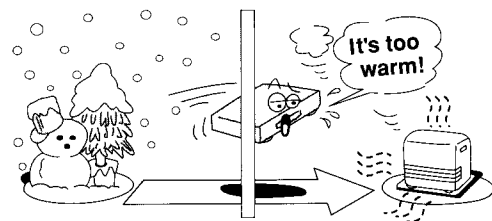

■ **Do not use the DVD video player when moisture condensation may occur.**

If you use the DVD video player in such a situation, it may damage discs and internal parts. Remove the disc, connect the power cord of the DVD video player to the wall outlet, turn on the DVD video player, and leave it for two or three hours. After two or three hours, the DVD video player will have warmed up and evaporated any moisture. Keep the DVD video player connected to the wall outlet and moisture condensation will seldom occur.

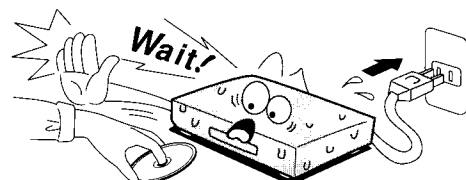

Table of Contents

Introduction

- SAFETY PRECAUTIONS 1
- IMPORTANT SAFETY INSTRUCTIONS 2-4
- Precautions 5
- Identification of Controls 7-10
 - Front Panel / Rear Panel / DVD display
 - Remote Control
 - Preparing the Remote Control
 - Operating with the Remote Control

Introduction

Connections

- Connecting to a TV 11
- Connecting to an Audio System 12
- Connecting to Optional Equipment ... 13, 14
 - Enjoying Dolby Digital (AC-3) Sound
 - Enjoying Dolby Pro Logic Surround Sound
 - Enjoying 2 Channel Digital Stereo Sound

Connections

Basic Playback

- Playing a Disc 15-18
 - Basic Playback
 - Playing at ×2, ×8 or ×30 the Normal Speed
 - Playing Frame by Frame
 - Playing in Slow-Motion
 - Resuming Playback from the Same Location
- Locating a Specific Title, Chapter, or Track 19, 20
 - Locating a Title Using the Title Menu
 - Locating a Title
 - Locating a Specific Chapter or Track Directly
 - Locating a Specific Chapter or Track
 - Locating a Specific Location by Entering the Time

Basic Playback

Advanced Playback

- Playing Repeatedly 21
 - Repeating a Title, Chapter, or Track
 - Repeating a Specific Segment
- Playing in a Favorite Order 22
 - Setting Titles, Chapters, or Tracks in a Favorite Order
- Playing in Random Order 23
 - Playing Titles in Random Order
 - Playing Chapter or Tracks in Random Order
- Zooming a Picture/
Playing 3-D (N-2-2) Sound 24
 - Zooming a Picture
 - Playing 3-D (N-2-2) Sound
- Selecting the Camera Angle 25
 - Changing the Camera Angle
- Selecting a Language 26
 - Selecting a Playback Audio Setting
- Selecting Subtitles 27
 - Turning Subtitles on or off
 - Selecting a Subtitle Language
- Using the On-Screen Display 28
 - Checking the Operational Status
 - Checking the Remaining Time and Setting Status

Advanced Playback

Function Setup

- Customizing the Function Settings 29-36
 - Displaying the SET UP MENU Screen
 - Setting the Audio
 - Setting the Operation Modes
 - Setting the Displays
- Setting the Parental Lock 37, 38
 - Setting the Parental Lock
- Table of Languages 39

Function Setup

Others

- Notes on Discs 40
 - Notes on Region Numbers
- Before Calling Service Personnel 41
- Specifications 42
- LIMITED WARRANTY
DVD VIDEO PLAYER 43

Others

Identification of Controls

See the page in  for details.

Front Panel / Rear Panel / DVD Display

Front Panel

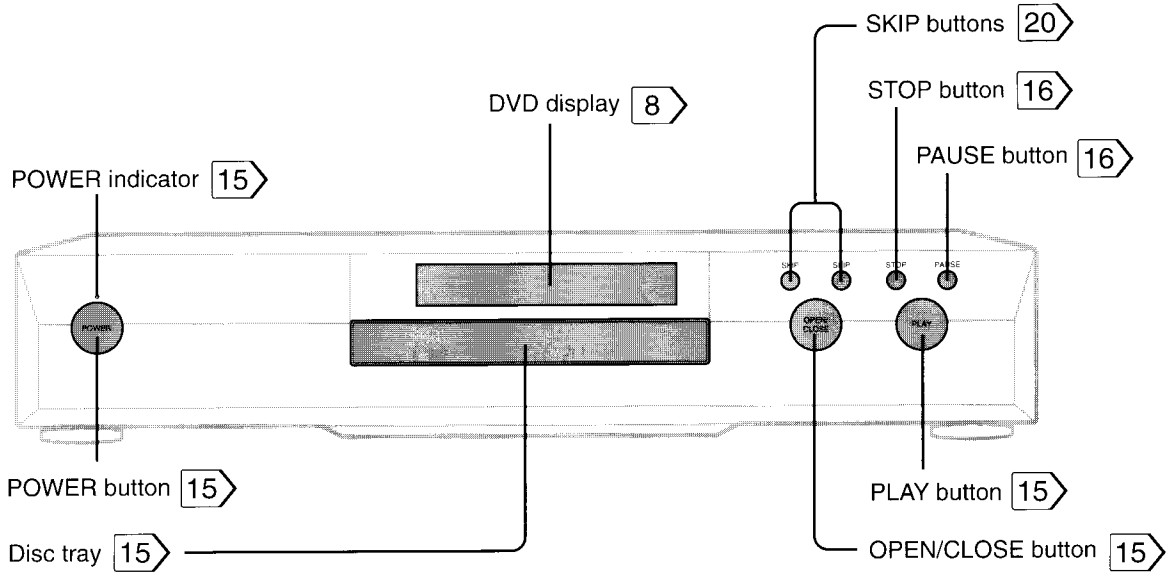

Rear Panel

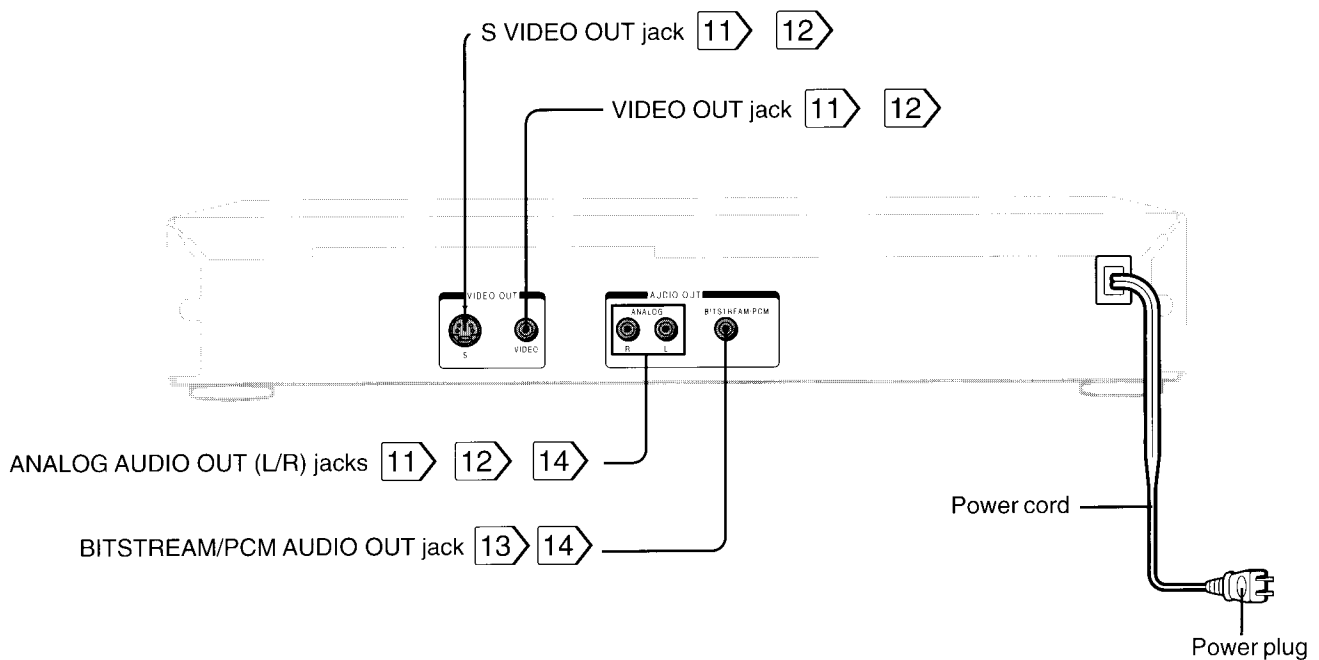

DVD Display

■ Pressing of the FL DIMMER button on the remote control turns the DVD display on or off.

FL DIMMER
 On ← → Off

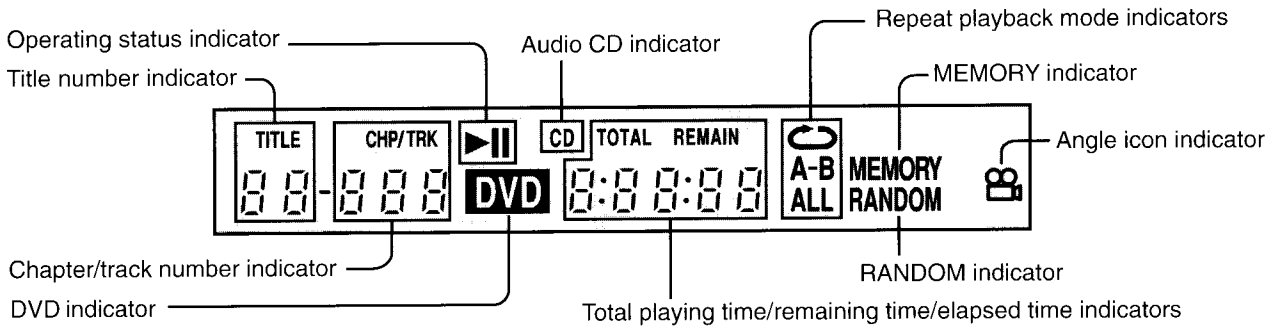

■ The indicators vary depending on the kinds of discs you play.

DVD Video disc

- When closing the disc tray:

Example



Total number of titles

- During playback:

Example

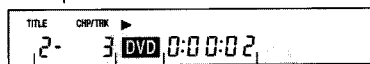

Playing chapter 3 in title 2 Elapsed time of the current title

Some DVD video discs may not display the chapter numbers or elapsed time.

Audio CD

- When closing the disc tray:

Example

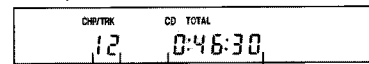

Total number of tracks Total playing time of the disc

- During playback:

Example

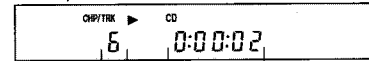



Playing track 6 Elapsed time of the current track

Other indicators

 When playing back the same title, chapter or track repeatedly. [21]

 When playing back a specific segment repeatedly. (A-B repeat) [21]

 When playing back the entire disc repeatedly. [21]

 When playback is paused. [16]

 During memory playback. [22]

 When the camera angle can be changed. [25]

 During random playback. [23]

RANDOM

Identification of Controls (continued)

The instructions in this manual describe the functions on the remote control. See the page in  for details.

Remote Control

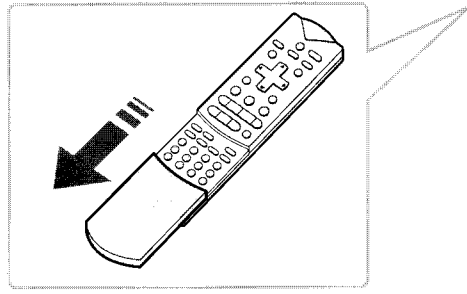
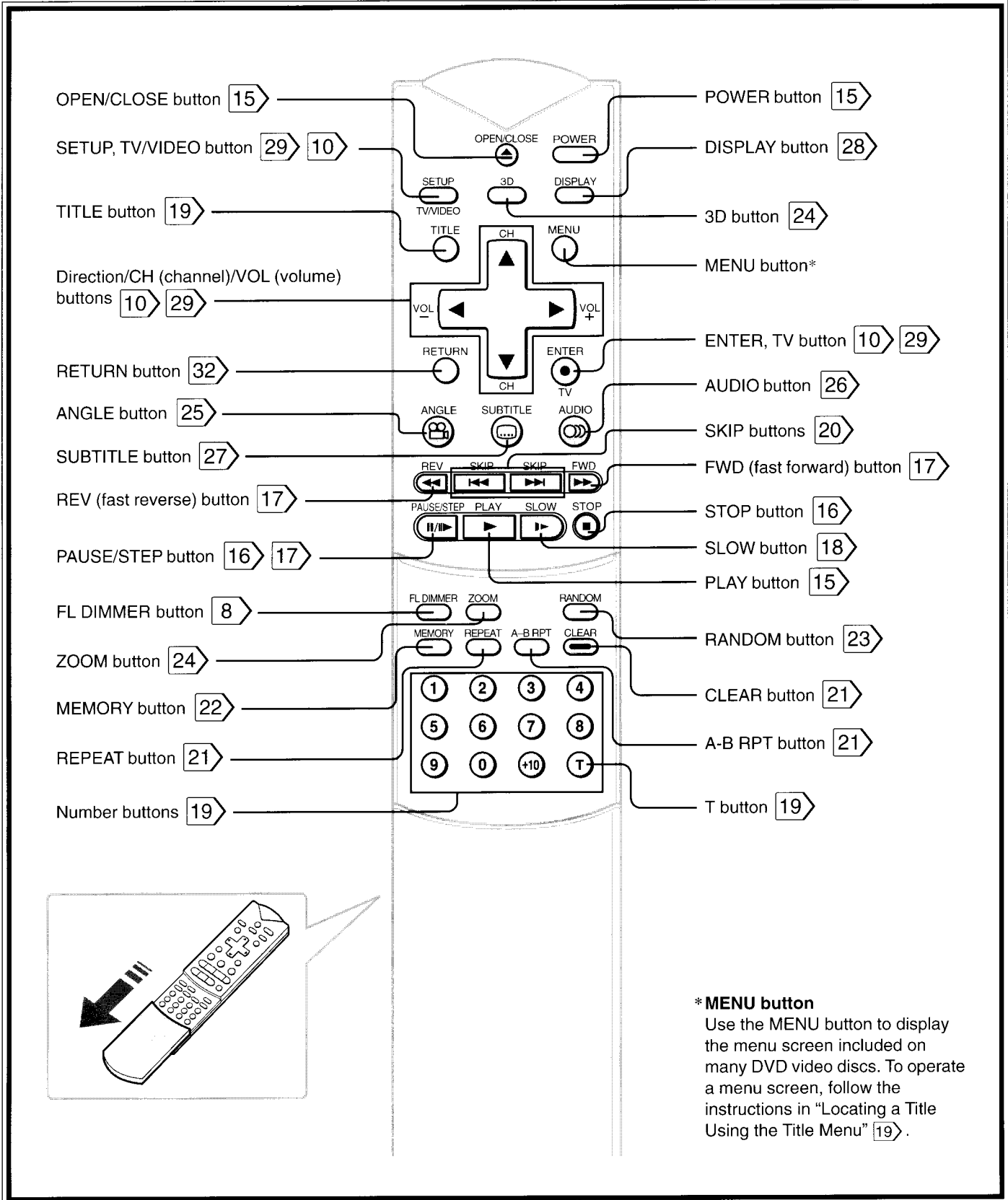

*** MENU button**
 Use the MENU button to display the menu screen included on many DVD video discs. To operate a menu screen, follow the instructions in "Locating a Title Using the Title Menu" [19](#).

Preparing the Remote Control

Insert the batteries into the remote control so you can use it to operate the DVD video player.

1 **Open the cover.**

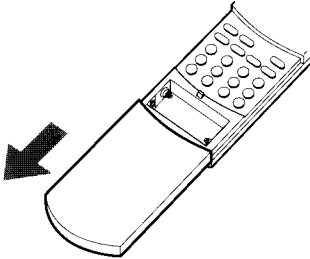

2 **Insert batteries (AAA size).**

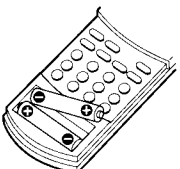

Make sure to match the + and - on the batteries to the marks inside the battery compartment.

3 **Close the cover.**

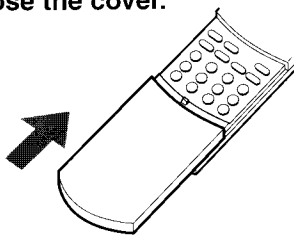

Notes on batteries

- Improper use of batteries may cause battery leakage and corrosion. To operate the remote control correctly, follow the instructions below.
- Do not insert batteries into the remote control in the wrong direction.
 - Do not charge, heat, open, or short-circuit the batteries. Do not throw batteries into a fire.
 - Do not leave dead or exhausted batteries in the remote control.
 - Do not use different types of batteries together, or mix old and new batteries.
 - If you do not use the remote control for a long period of time, remove the batteries to avoid possible damage from battery corrosion.
 - If the remote control does not function correctly or if the operating range becomes reduced, replace all batteries with new ones.
 - If battery leakage occurs, wipe the battery liquid from the battery compartment, then insert new batteries.
 - The batteries should last about one year with normal use.

Operating with the Remote Control

This section shows you how to use the remote control.

Point the remote control at the remote sensor and press the buttons.

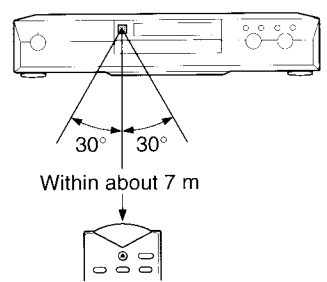

Distance: About 7 m from the front of the remote sensor
 Angle: About 30° in each direction of the front of the remote sensor

* Do not expose the remote sensor of the DVD video player to a strong light source such as direct sunlight or other illumination. If you do so, you may not be able to operate the DVD video player via the remote control.

To operate a Toshiba TV

You can use some buttons on this remote control to operate a Toshiba TV.

While holding down the TV button, press the following buttons.

Point the remote control at the TV to operate.

- Hold down. CH ▲ / ▼ : To select a channel.
 ▲ : up / ▼ : down
- VOL +/- : To adjust the volume.
- TV/VIDEO : To select the video input.



- * Some Toshiba TVs may not be compatible with this remote control.
- * If you press the TV (ENTER) button while the DVD video player is operating, playback may be interrupted. Be sure to point the remote control at the TV when you want to operate the TV.

Notes on the remote control

- Direct the remote control at the remote sensor of the DVD video player.
- Do not drop or give the remote control a shock.
- Do not leave the remote control near an extremely hot or humid place.
- Do not spill water or put anything wet on the remote control.
- Do not open the remote control.

Connecting to a TV

Connect the DVD video player to your TV.

Connecting to a TV

■ Setting of the output sound type

From the on-screen displays, set the "AUDIO OUT SEL." to "ANALOG." 29 31

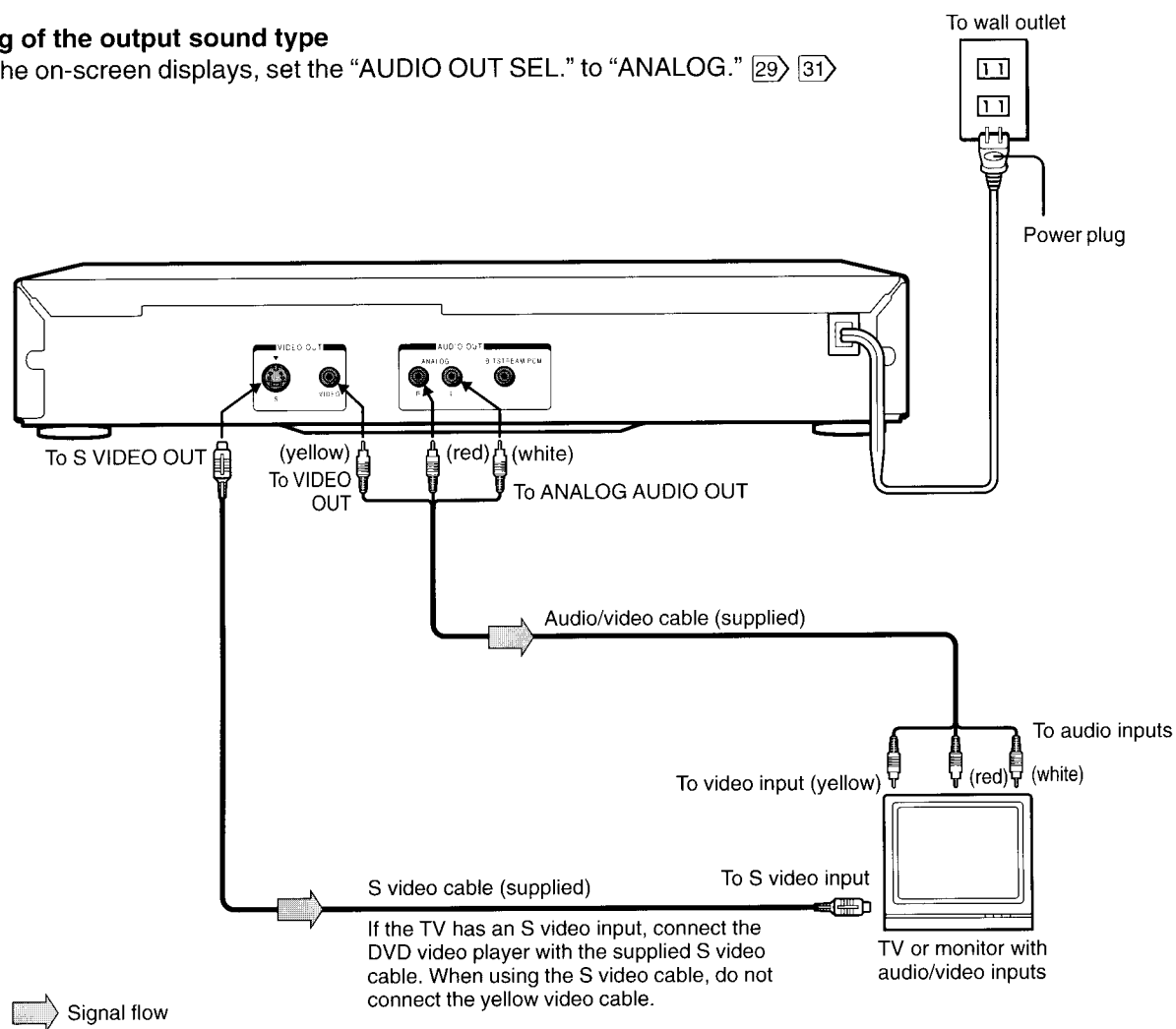

Notes

- Refer to the owner's manual of the connected TV as well.
- When you connect the DVD video player to your TV, be sure to turn off the power and unplug both units from the wall outlet before making any connections.
- If your television set has one audio input, connect the DVD video player to a Y cable adapter (not supplied) and then connect to your TV.
- Connect the DVD video player to your TV directly. If you connect the DVD video player to a VCR, TV/VCR combination or video selector, the playback picture may be distorted as DVD video discs are copy protected.

Connecting to an Audio System

You can listen to the sound of audio CDs and DVD video discs in stereo.

Connecting to an Audio System

Setting of the output sound type

From the on-screen displays, set the "AUDIO OUT SEL." to "ANALOG". 29 31

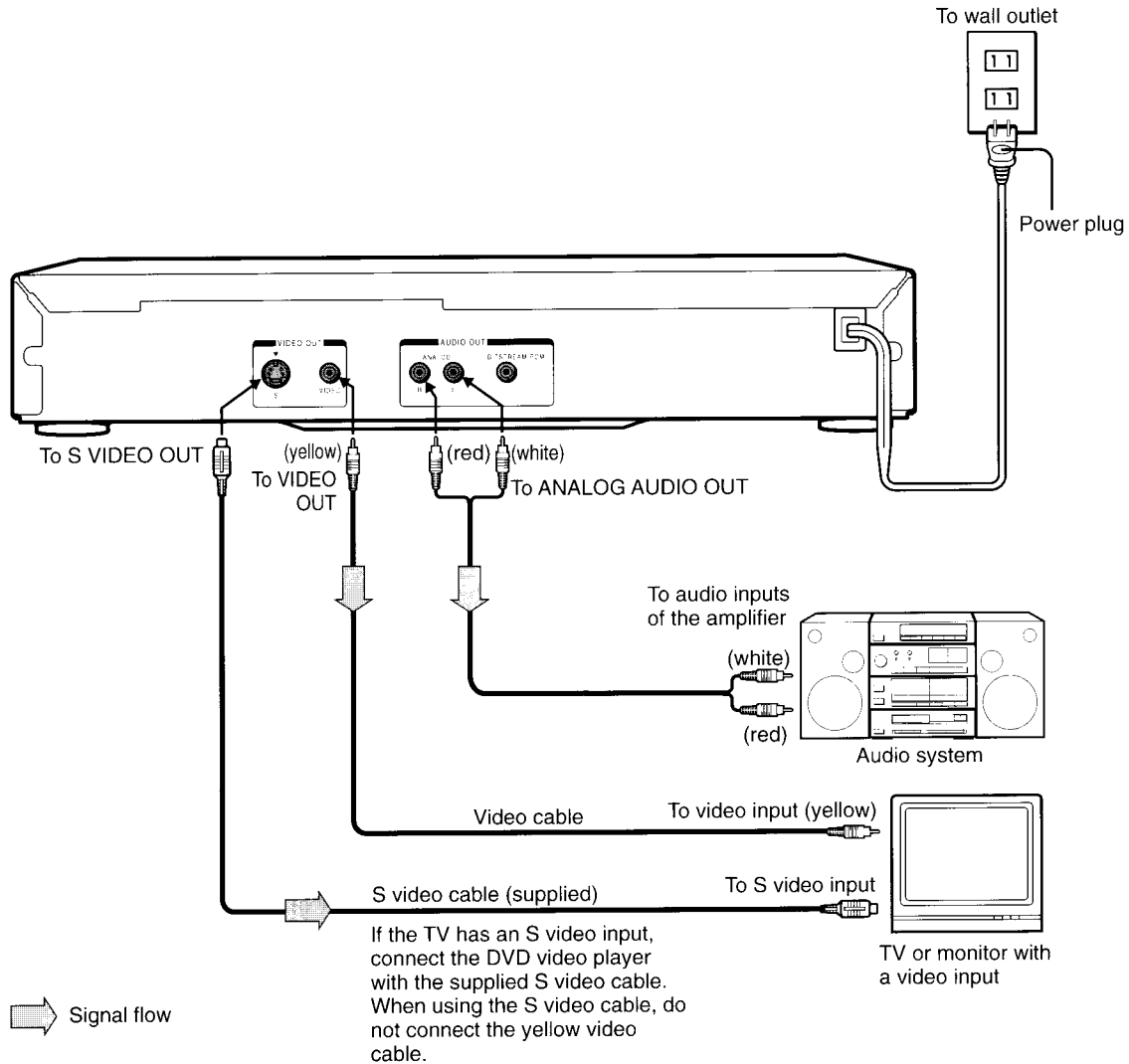

Notes

- Refer to the owner's manual of the connected equipment as well.
- When you connect the DVD video player to other equipment, be sure to turn off the power and unplug all of the equipment from the wall outlet before making any connections.
- If you place the DVD video player near a tuner or radio, the radio broadcast sound might be distorted. In this case, place the DVD video player away from the tuner and radio.
- The output sound of the DVD video player has a wide dynamic range. Be sure to adjust the receiver's volume to a moderate listening level. Otherwise, the speakers may be damaged by a sudden high volume sound.
- Turn off the amplifier before you connect or disconnect the DVD video player's power cord. If you leave the amplifier power on, the speakers may be damaged.

Connecting to Optional Equipment

You can enjoy the high quality dynamic sound of Dolby Digital (AC-3), Dolby Pro Logic, and 2 Channel Digital Stereo.

Enjoying Dolby Digital (AC-3) Sound

Dolby Digital (AC-3)

Dolby Digital is the surround sound technology used in theaters showing the latest movies, and is now available to reproduce this realistic effect in the home. You can enjoy motion picture and live concert DVD video discs with this dynamic realistic sound by connecting the DVD video player to a 6 channel amplifier equipped with a Dolby Digital (AC-3) decoder or Dolby Digital (AC-3) processor. If you have a Dolby Pro Logic Surround decoder, you will obtain the full benefit of Pro Logic from the same DVD movies that provide full 5.1-channel Dolby Digital soundtracks, as well as from titles with the Dolby Surround mark.

Setting of the output sound type

- From the on-screen displays, set the "AUDIO OUT SEL." to "BITSTREAM". 29 31
- Select "AC-3" from the sound recording systems of the disc. 26

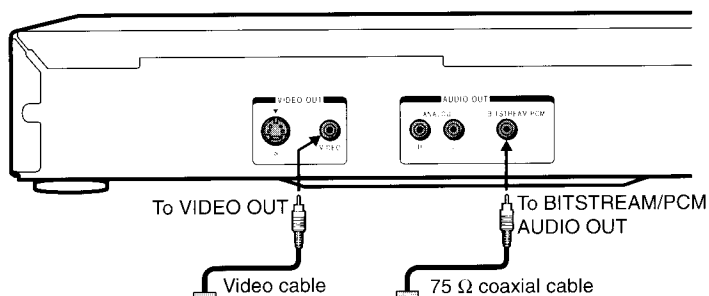

Connection example

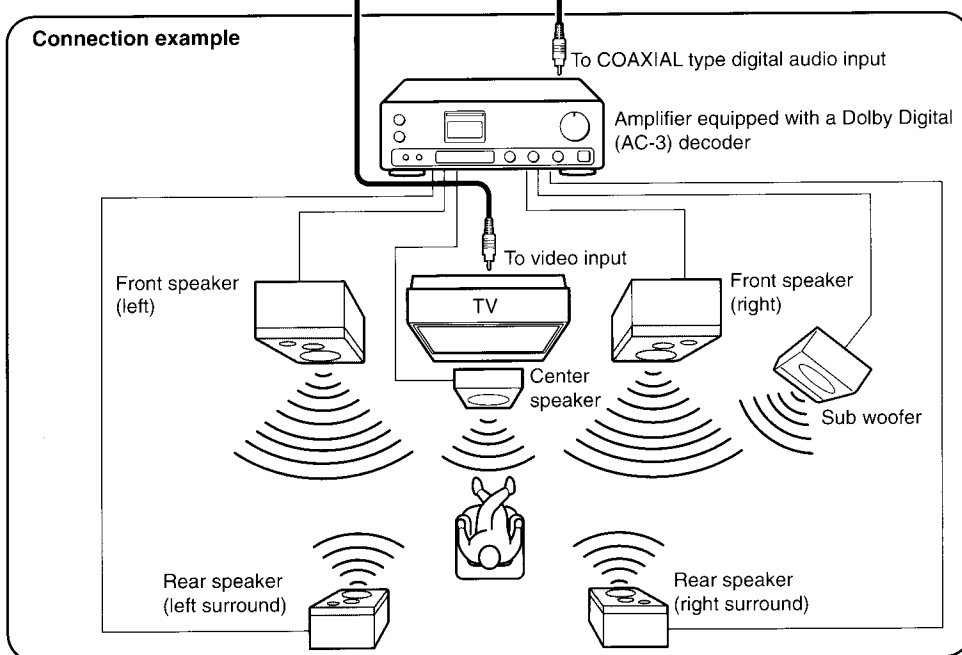

Standard equipment to enjoy Dolby Digital (AC-3)

- The DVD video player (equipped with a BITSTREAM output jack)
- DVD video discs recorded in Dolby Digital (AC-3)
- 6 channel amplifier equipped with a Dolby Digital (AC-3) decoder, or Dolby Digital (AC-3) processor and power amplifier
- 5 speakers and 1 sub woofer

Manufactured under license from Dolby Laboratories Licensing Corporation. "Dolby," "AC-3," "Pro Logic," and the double-D symbol are trademarks of Dolby Laboratories Licensing Corporation.

Notes

- DO NOT connect the BITSTREAM/PCM AUDIO OUT jack of the DVD video player to the AC-3 RF input of a Dolby Digital Receiver. This input on your A/V Receiver is reserved for Laserdisc use only and is not compatible with the BITSTREAM/PCM AUDIO OUT jack of the DVD video player.
- Connect the BITSTREAM/PCM AUDIO OUT jack of the DVD video player to the "DIGITAL" or "COAXIAL" input of a Dolby Digital Receiver or Processor.
- Refer to the owner's manual of the connected equipment as well.
- When you connect the DVD video player to other equipment, be sure to turn off the power and unplug all of the equipment from the wall outlet before making any connections.
- The output sound of the DVD video player has a wide dynamic range. Be sure to adjust the receiver's volume to a moderate listening level. Otherwise, the speakers may be damaged by a sudden high volume sound.
- Turn off the amplifier before you connect or disconnect the DVD video player's power cord. If you leave the amplifier power on, the speakers may be damaged.

Warning

Do not set "AUDIO OUT SEL." to "BITSTREAM" from the menu [29] [31] unless you are connecting (via the BITSTREAM/PCM AUDIO OUT jack) an AV decoder that has the Dolby Digital (AC-3) decoding function. High volume sound may damage your hearing as well as the speakers.

Enjoying Dolby Pro Logic Surround Sound

Dolby Pro Logic Surround

You can enjoy the dynamic realistic sound of Dolby Pro Logic Surround by connecting an amplifier and speaker system (right and left front speakers, a center speaker, and one or two rear speakers).

- **With an amplifier equipped with Dolby Digital (AC-3)**
Connect the equipment the same way as described in "Enjoying Dolby Digital (AC-3) Sound" [13]. Refer to that amplifier's owner's manual and set the amplifier so you can enjoy Dolby Pro Logic Surround sound.
- **With an amplifier not equipped with Dolby Digital (AC-3)**
Connect the equipment as follows.

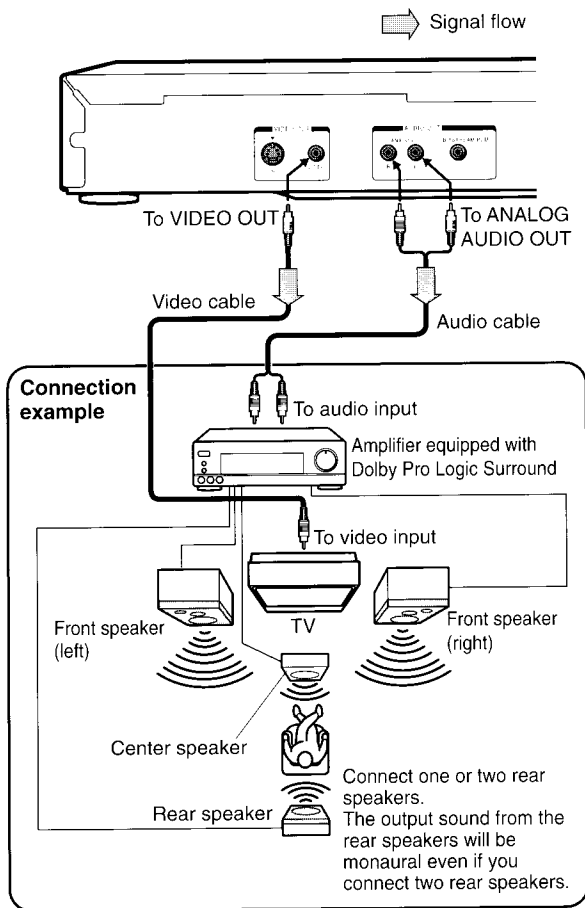

- Set "AUDIO OUT SEL." to "ANALOG" via the on-screen displays. [29] [31]

Enjoying 2 Channel Digital Stereo Sound

2 Channel Digital Stereo

You can enjoy the dynamic sound of 2 Channel Digital Stereo by connecting an amplifier equipped with a digital audio input and speaker system (right and left front speakers).

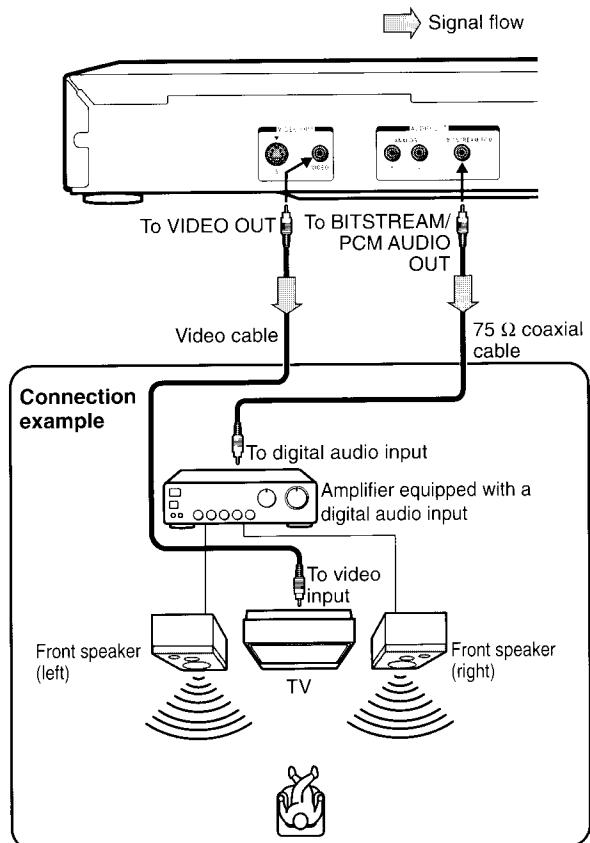

- Set "AUDIO OUT SEL." to "PCM" via the on-screen displays. [29] [31]

Notes

- Refer to the owner's manual of the connected equipment as well.
- When you connect the DVD video player to other equipment, be sure to turn off the power and unplug all of the equipment from the wall outlet before making any connections.
- The output sound of the DVD video player has a wide dynamic range. Be sure to adjust the receiver's volume to a moderate listening level. Otherwise, the speakers may be damaged by a sudden high volume sound.
- Turn off the amplifier before you connect or disconnect the DVD video player's power cord. If you leave the amplifier power on, the speakers may be damaged.

Playing a Disc

CAUTION
Keep your fingers well clear of the disc tray as it is closing. Neglecting to may cause serious personal injury.

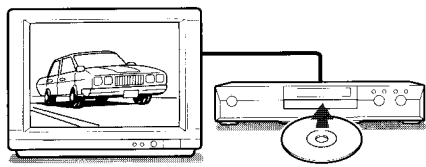



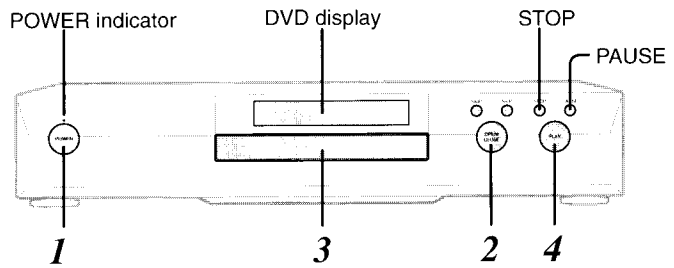

This section shows you the basics on how to play a disc.



Basic Playback

■ Preparations

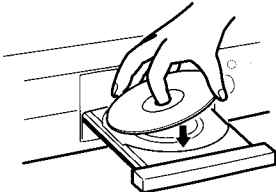
- When you want to play DVD video discs, turn on the TV and select the video input connected to the DVD video player.
- When you want to enjoy the sound of discs from the audio system, turn on the audio system and select the input connected to the DVD video player.
- For connection details, see “Connections”. [11](#) - [14](#)
- Set the playback picture size according to the aspect ratio of the connected TV via the on-screen displays. [29](#) [35](#)

1	<p>POWER</p>  <p>Press POWER.</p> <p>The DVD video player turns on and the POWER indicator on the player illuminates.</p>	
2	<p>OPEN/CLOSE</p>  <p>Press OPEN/CLOSE.</p> <p>The disc tray opens.</p>	
3	<p>Place the disc on the disc tray.</p>  <p>With the playback side down</p>	<p>Notes</p> <ul style="list-style-type: none"> • There are two different disc sizes. Place the disc in the correct guide on the disc tray. If the disc is out of the guide, it may damage the disc and cause the DVD video player to malfunction. • Do not place anything except DVD video discs or audio CDs on the disc tray.
4	<p>PLAY</p>  <p>Press PLAY.</p> <p>The disc tray closes and playback starts.</p> <p>If you insert a DVD video disc that contains a title menu, the menu screen will appear. See “To start playback from the menu screen” 16.</p>	<p>Note</p> <p>You may need to press the TITLE or MENU button on the remote control to display the disc menu screen (depending on the actual DVD video disc.)</p>

Notes

- Do not move the DVD video player during playback. Doing so may damage the disc.
- Use the OPEN/CLOSE button on the remote control or DVD video player to open and close the disc tray. Do not push the disc tray while it is moving. Doing so may cause the DVD video player to malfunction.
- Do not push up on the disc tray or put any objects other than discs on the disc tray. Doing so may cause the DVD video player to malfunction.

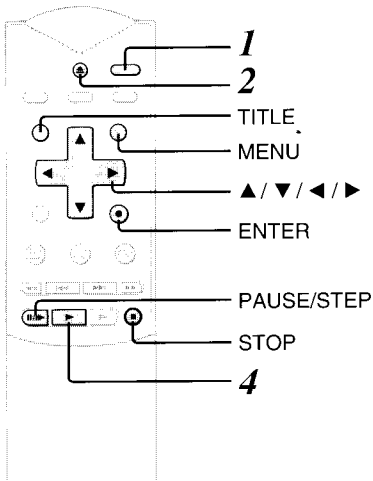

■ **To obtain a higher quality picture**

Occasionally, some picture noise not usually displayed with a normal broadcast may appear on the TV screen while playing a DVD video disc because the high resolution pictures on these discs include a lot of information. While the amount of noise depends on the TV you use with this DVD video player, you should generally reduce the sharpness adjustment on your TV when viewing DVD video discs.

■ **About**

The icons on the heading bar show the playable discs for the function described under that heading.

: You can use this function with DVD video discs.

: You can use this function with audio CDs.

To start playback from the menu screen

1 Press / / / or the number buttons to select the title you want.

e.g.

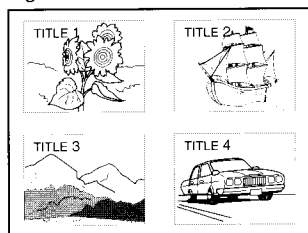
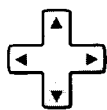

2 Press ENTER.

ENTER The DVD video player begins playback from the selected title.



To stop playback

STOP



Press STOP.

To remove the disc

OPEN/CLOSE



Press OPEN/CLOSE.

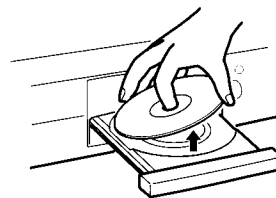

Remove the disc after the disc tray opens completely.

- Be sure to press the OPEN/CLOSE button to close the disc tray after you remove the disc.

To pause playback (still mode)

PAUSE/STEP



Press PAUSE/STEP during playback.

To resume normal playback, press the PLAY button.

- The sound is muted during still mode.

Notes

- In many instances, a menu screen will appear after playback of a movie is completed. Prolonged display of an on-screen menu may damage your television set, permanently etching that image onto its screen. To avoid this, be sure to press the STOP button on your remote control once the movie is completed.
- If you pause a picture and leave it still for a long while, the screen saver of the DVD video player automatically appears. To turn off the screen saver, press the PLAY button.

Basic Playback

Playing a Disc

(continued)

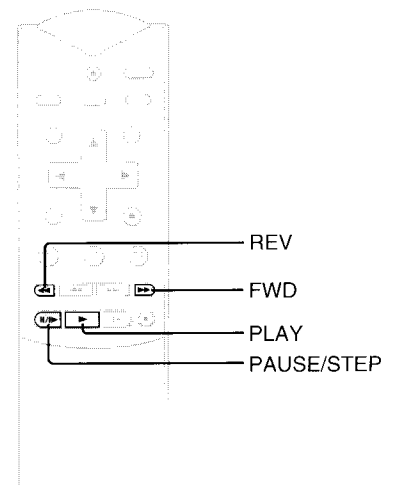
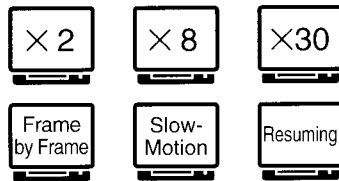

You can play discs at various speeds, and resume playback from the location where you stopped playback.

Playing at $\times 2$, $\times 8$ or $\times 30$ the Normal Speed

You can play a disc at $\times 2$, $\times 8$ or $\times 30$ the normal speed.

Playing Frame by Frame

You can advance a picture frame by frame.



Press REV or FWD during playback.

• DVD video disc

Each time you press the REV or FWD button, the playback speed changes.

REV: Fast reverse playback

FWD: Fast forward playback

TV screen

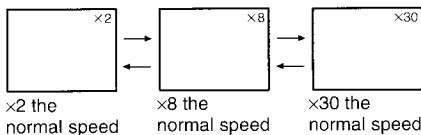

• Audio CD

The fast reverse or fast forward playback alternates between two speeds.

TV screen

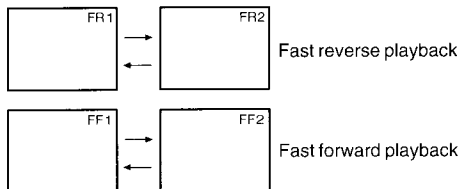

Press PAUSE/STEP during still playback.

Each time you press the PAUSE/STEP button, the picture advances one frame.

To resume normal playback

PLAY



Press PLAY.

To resume normal playback

PLAY



Press PLAY.

Notes

- The DVD video player does not play sound and subtitles during reverse and forward scan of DVD video discs. However, the DVD video player plays sound during fast forward or fast reverse play of audio CDs.
- The $\times 2$, $\times 8$ and $\times 30$ speeds are only approximate speeds. These speeds may vary slightly from disc to disc.

Note

The sound is muted during frame by frame playback.

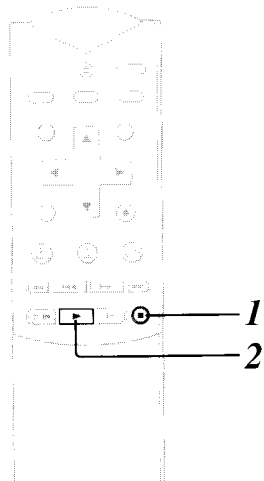
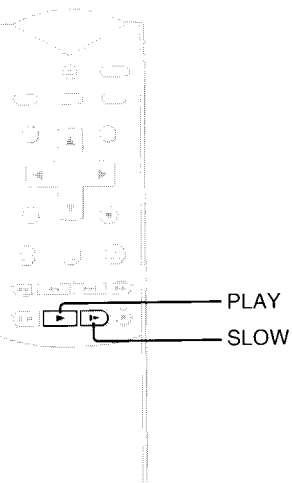

Playing in Slow-Motion DVD

You can play a disc in slow-motion.



Press SLOW during playback.

Each time you press the SLOW button, the slow-motion speed changes.

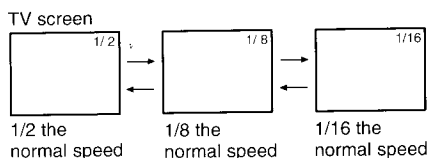

Resuming Playback from the Same Location DVD CD

You can stop playback and resume playback later from the same location on the disc.



Press STOP at the location where you want to interrupt playback.

The DVD video player memorizes the location where you stopped playback.



Press PLAY.

The DVD video player resumes playback from the location where you stopped playback.

Basic Playback

To start playback from the beginning regardless of the location where you stopped playback

1 Press STOP twice.

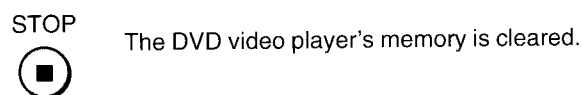

2 Press PLAY.

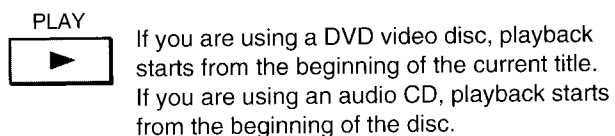

- If you want to return to the beginning of a DVD video disc, open and close the disc tray once with the OPEN/CLOSE button before pressing the PLAY button.

To resume normal playback



Note

The sound is muted during slow-motion playback.

Notes

- The DVD video player's memory is also cleared when:
 - you unplug the DVD video player from the wall outlet after you stop playback.
 - you open the disc tray.
 - you adjust/change parental lock [37] or select a disc menu language setting [36].
- There may be a difference of the location where playback resumes depending on the disc.
- If you change the initial settings of languages [31] or subtitle languages [36] while the DVD video player is stopped, these new settings will function only after the DVD video player's memory is cleared.

Locating a Specific Title, Chapter, or Track

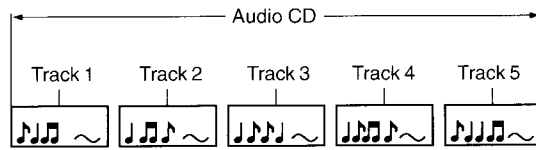
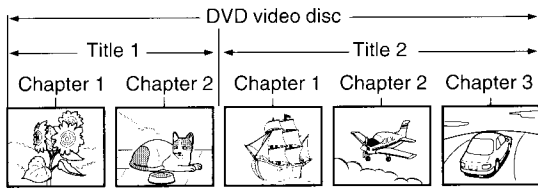

Normally, DVD video discs are divided into titles, and the titles are sub-divided into chapters. Audio CDs are divided into tracks. You can quickly locate any specific title, chapter, or track.

Locating a Title Using the Title Menu

If a DVD video disc contains a title menu, you can locate a specific title using the title menu function.



Press TITLE.

The title menu appears on the TV screen.

Example of a title menu

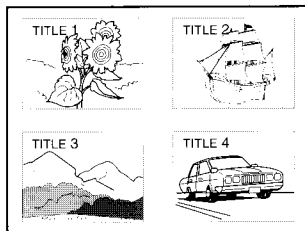

Press ▲ / ▼ / ◀ / ▶ to select the title you want.

If the titles in the title menu are assigned a number, you can directly locate a specific title by pressing its designated number with the **number buttons**.



Press ENTER.

The DVD video player starts playback from chapter 1 of the selected title.

Notes

- The instructions above describe basic procedures which may vary depending on the contents of the DVD video disc. If different instructions appear on the TV screen, follow those instructions.
- If you display the title menu during playback and press the TITLE button again without selecting any title, the DVD video player resumes playback from the point where you first pressed the TITLE button.

Locating a Title

If a DVD video disc contains title numbers, you can locate a specific title by directly selecting a title number.



Press T.

Make sure that the space next to TITLE is highlighted.

e.g.

TITLE: **1**
CHAPTER: 1

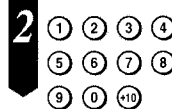

Press the corresponding number buttons for the title you want.

e.g. To select title 2



TITLE: **2**
CHAPTER: 1

To select title 12

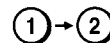

TITLE: **12**
CHAPTER: 1



Press PLAY.

The DVD video player starts playback from chapter 1 of the selected title.

Notes

- You can shift the highlighted space between TITLE and CHAPTER by pressing ▲ / ▼.
- Pressing the CLEAR button resets the TITLE and CHAPTER numbers. To clear the TITLE, CHAPTER display, press the T button several times.
- You can select a preferred language for on-screen displays. **29** **35**

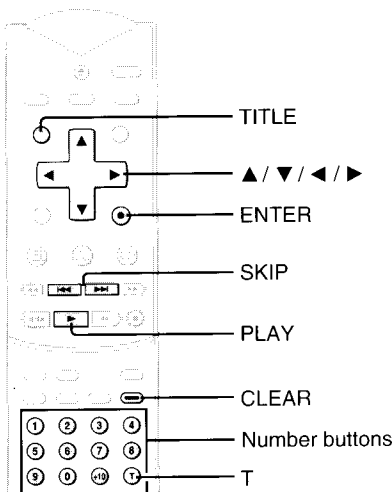

DVD CD

DVD CD

Locating a Specific Chapter or Track Directly

If you know the chapter or track number you want to play, you can locate it directly.

1 **Press T.**
Skip steps 1 and 2 if you are using an audio CD.
(DVD video disc)

TITLE: 1
CHAPTER: 1

2 **Press ▼ to highlight the space next to CHAPTER.**
(DVD video disc)

TITLE: 1
CHAPTER:

3 **Press the corresponding number buttons of the chapter or track you want.**
You can use the button to select numbers from 10 through 99.

e.g. To select chapter or track 25

- → (DVD video disc) (Audio CD)
- → → (DVD video disc) (Audio CD)

TITLE: 1
CHAPTER: 25 TRACK: 25

4 **Press PLAY.**
The DVD video player starts playback from the selected chapter or track.

To select a title and chapter number at the same time

e.g. To select chapter 25 in title 2

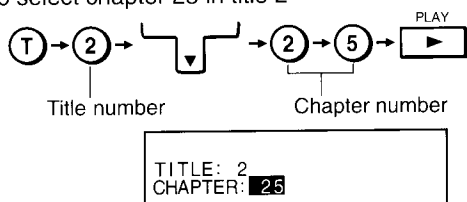

Note

Pressing the CLEAR button resets the TITLE and CHAPTER numbers. To clear the TITLE, CHAPTER display, press the T button several times.

Locating a Specific Chapter or Track

You can locate consecutive chapters or tracks.



Press SKIP or repeatedly to display the chapter or track number you want.



The DVD video player starts playback from the selected chapter or track.

: To locate preceding chapters or tracks
When you press the SKIP button, the DVD video player starts playback from the beginning of the current chapter or track. When you press the SKIP button twice, the DVD video player starts playback from the beginning of the preceding chapter or track.

: To locate succeeding chapters or tracks

Note

Some titles may not display chapter numbers.

DVD CD

Locating a Specific Location by Entering the Time

You can locate a specific location by entering the time (hours, minutes, seconds).

1 **Press T twice.**
You may have to press further depending on the disc. Press the button repeatedly until the following indication appears.

TIME **: :**

2 **Press the number buttons to enter the time.**
e.g. → → → →

TIME 1:25:30

3 **Press PLAY.**
The DVD video player starts playback from the specified location.

Notes

- Some discs may not respond to this process.
- Some scenes may not be located correctly as you specified.
- This method for accessing specific locations is available only within the current title of the DVD video disc or within the current track of the audio CD.

Playing Repeatedly

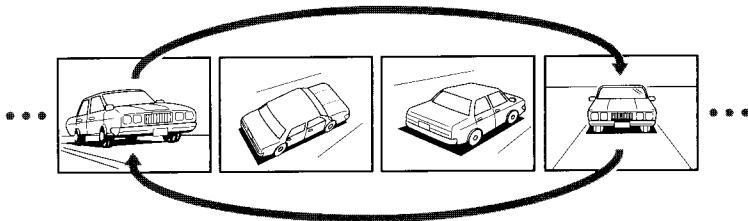

You can play a specific title, chapter, track, or segment repeatedly. (Title repeat, chapter/track repeat, A-B repeat)

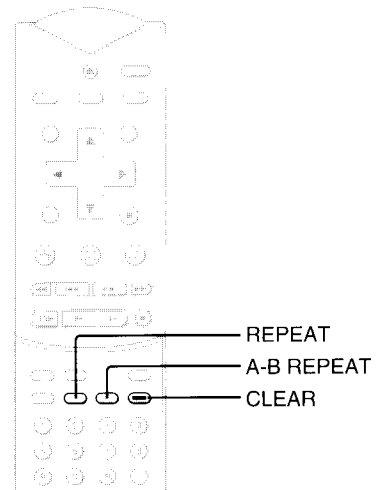

Repeating a Title, Chapter, or Track

You can play the same title, chapter, or track repeatedly. (Title, chapter/track repeat)

1 Select the title, chapter, or track you want to repeat. [19] [20]

2 Press REPEAT.



Each time you press the REPEAT button, the repeat mode changes as follows.

• DVD video disc

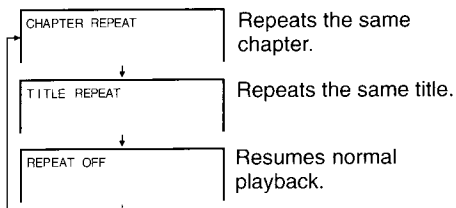

• Audio CD

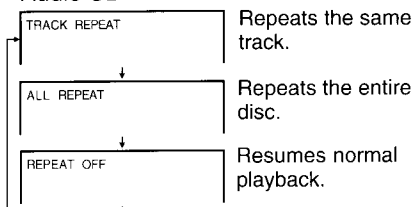

To resume normal playback



Press CLEAR.

Note

Some discs may not permit repeat operation.

Repeating a Specific Segment

You can play a specific segment repeatedly. (A-B repeat)

1 Press A-B RPT at the beginning of the segment (point A) you want to play repeatedly.

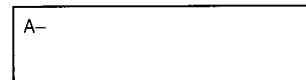

2 Press A-B RPT again at the end of the segment (point B).



The DVD video player automatically returns to point A and starts repeat playback of the selected segment (A-B).

To resume normal playback



Press CLEAR.

Notes

- Some discs may not permit A-B repeat operation.
- You cannot set the A-B repeat function for a segment that includes multiple camera angles.
- You can specify a segment only within the current title.
- There may be a slight difference between point A and the location where playback actually resumes depending on the disc.

Playing in a Favorite Order

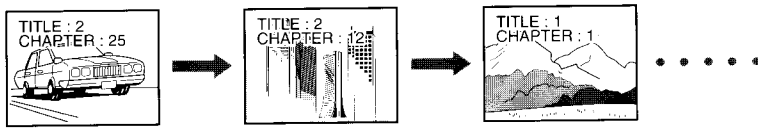

You can combine your favorite titles, chapters, or tracks and play them in any order. You can program up to 30 items into the memory. (Memory playback)

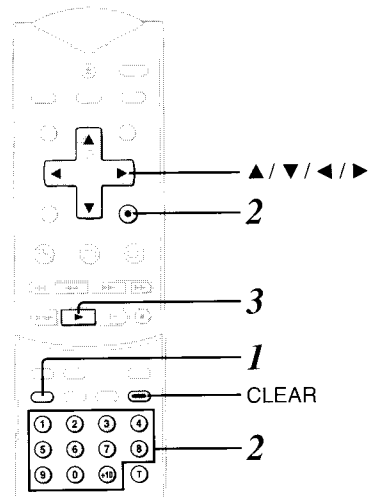

DVD CD

Setting Titles, Chapters, or Tracks in a Favorite Order

The DVD video player automatically plays titles, chapters, or tracks in the order you program.

1 MEMORY

Insert a disc and press MEMORY during stop.

The following menu appears.

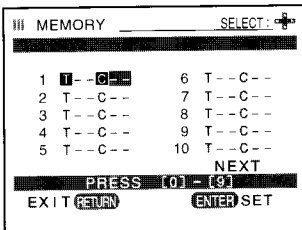

T: Title number C: Chapter number

2

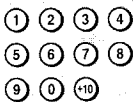

Select the items you want in order by pressing the number buttons, then ENTER for each item.

Each time you press the ◀/▶ button, the -- indication next to T and C is highlighted in turn. Highlight where you want to enter, then press the number buttons.

e.g. To play chapter 25 in title 2, chapter 12 in title 2, all the chapters in title 1, and chapter 2 in title 4.

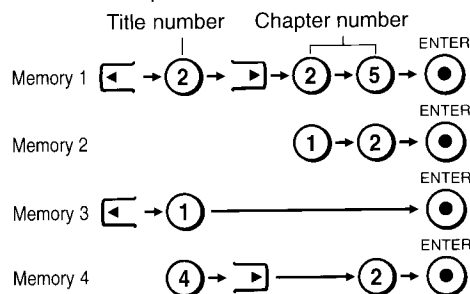

To select tracks from an audio CD in order, press the number buttons for the track, then press the ENTER button for each item you want.

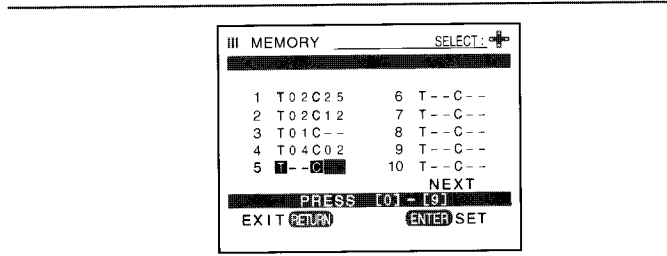

To select another chapter in the same title, you do not need to select the title number.

3 PLAY



Press PLAY while the MEMORY menu appears on the TV screen.

The DVD video player starts memory playback.

To change the programmed items

- While the MEMORY menu appears on the TV screen, press ▲/▼ to move the highlighted bar to the item you want to change.
- Change the item following the instructions in step 2.

To cancel the programmed items

- While the MEMORY menu appears on the TV screen, press ▲/▼ to move the highlighted bar to the item you want to cancel.
- Press the CLEAR button.

To resume normal playback from memory playback



Press CLEAR.

The MEMORY indicator disappears.

Advanced Playback

Notes

- Some discs may not permit memory playback operation.
- If you press the REPEAT button during memory playback, the DVD video player repeats the current memory playback.
- If you press the MEMORY button during memory playback, the programmed selections will be displayed.
- You cannot select title, chapter, and track numbers not included on the disc.
- If you press the MEMORY or RETURN button while the MEMORY menu appears on the TV screen, the MEMORY menu disappears.
- The programmed items will be cleared when:
 - you turn off the DVD video player, or
 - you remove the disc.

Playing in Random Order

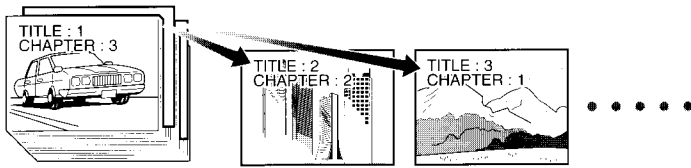

You can play titles, chapters within a title, or tracks in random order. (Random playback)

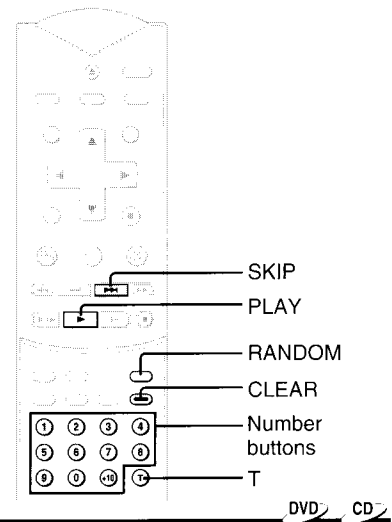

Playing Titles in Random Order

The DVD video player automatically selects the titles in a DVD video disc and plays them randomly.

1 **RANDOM** Press **RANDOM** twice during stop.

If you press the **RANDOM** button during playback, the DVD video player automatically starts random playback after finishing the current title.

2 **PLAY** Press **PLAY**.

The DVD video player starts random playback.

Press the **PLAY** button within about 5 seconds after you press the **RANDOM** button.

To resume normal playback

CLEAR Press **CLEAR**.

Notes

- Some discs may not permit random playback operation.
- You cannot use the random playback function in conjunction with the memory playback function.

Playing Chapters or Tracks in Random Order

The DVD video player automatically selects chapters within a title, or tracks in an audio CD, and plays them randomly.

1 **Number buttons** Press the appropriate number buttons for the title which contains the chapters you want to play in random order.

Skip this step if you are using an audio CD.

e.g. To play the chapters in title 2 in random order

(DVD video disc)

2 **RANDOM** Press **RANDOM** during stop.

(DVD video disc) (Audio CD)

If you press the **RANDOM** button during playback, the DVD video player automatically starts random playback after finishing the current chapter or track.

3 **PLAY** Press **PLAY**.

The DVD video player starts random playback.

Press the **PLAY** button within about 5 seconds after you press the **RANDOM** button.

To resume normal playback

CLEAR Press **CLEAR**.

Notes

- Some discs may not permit random playback operation.
- You cannot use the random playback function in conjunction with the memory playback function.
- If you press the **SKIP** button during random playback, the DVD video player goes to another chapter or track and starts random playback.

Zooming a Picture/ Playing 3-D (N-2-2) Sound

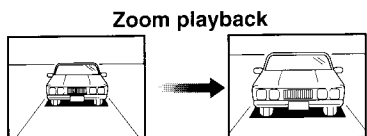

Zoom playback

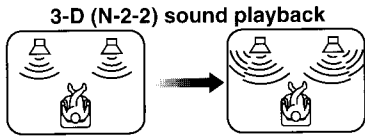

3-D (N-2-2) sound playback

You can magnify areas within a picture. (Zoom playback)
You can enjoy virtual surround sound. (3-D (N-2-2) sound playback)

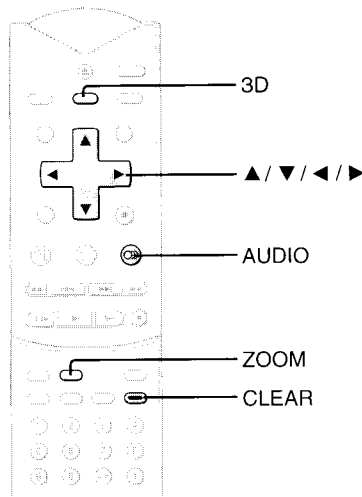

Zooming a Picture

You can zoom in on a picture and shift the zooming point as well.



Press ZOOM during normal, slow or still playback.

The DVD video player magnifies in the center of the picture.

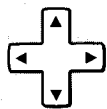
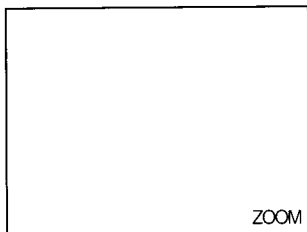

If you press **▲ / ▼ / ◀ / ▶** during zoom playback, the zoom point shifts. When the zoom point reaches an edge of the picture, the color of "ZOOM" changes. If you press the CLEAR button, the zoom point returns to the center of the picture.

To resume normal playback



Press ZOOM during zoom playback.

Notes

- Some discs may not respond to zoom feature.
- During some scenes, the buttons may not work correctly as described above.
- Zooming does not work on subtitles or menu screens included on DVD video discs.
- During zoom playback, the **▲ / ▼ / ◀ / ▶** buttons cannot work on menu screens included on the DVD video discs. If you want to use the menu screens, cancel the zoom playback.

Selecting 3-D (N-2-2) Sound Enhancement

You can enjoy expansive surround type effects from two speakers.



During playback, press AUDIO repeatedly until AC-3 appears on the screen.

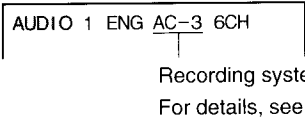

If AC-3 does not appear, the DVD video disc may not be recorded in the Dolby Digital (AC-3) recording system. On such a disc, the 3-D (N-2-2) sound enhancement cannot function.

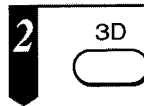

Press 3D.
The current setting appears.

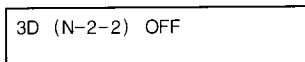

Press 3D to select ON.
Each time you press the button, ON and OFF alternates.

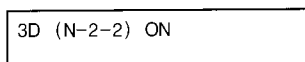

To turn off the 3-D (N-2-2) effect



In step 3, Press 3D to select OFF.

Notes

- The effect of 3-D (N-2-2) sound enhancement cannot be fully realized through headphones.
- You may sense a difference in volume between normal and 3-D enhanced sound.

Spatializer® 3-Dimensional Sound Processing provided by Desper Products, Inc.
Certain audio features of this product manufactured under a license from Desper Products, Inc., Spatializer® and the circle-in-square device are trademarks owned by Desper Products, Inc.

Advanced Playback

Selecting the Camera Angle

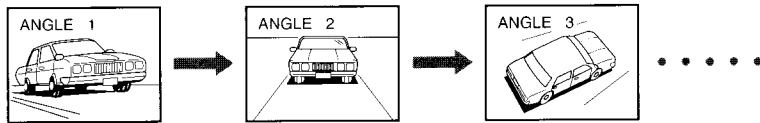

You can select a preferred camera angle to watch a scene.

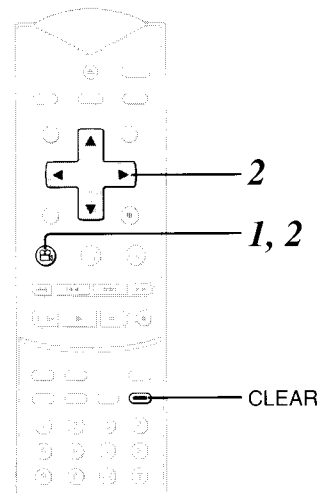

DVD

Changing the Camera Angle

If the scene was recorded from multiple angles, you can easily change the camera angle of the scene you are watching.

1 ANGLE



Press ANGLE while playing a scene recorded with multiple angles.

While playing a scene recorded with multiple angles, the angle icon () appears in the DVD display and on the TV screen.

Press the ANGLE button while the angle icon is on.

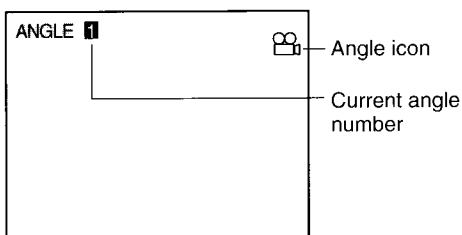

To turn off the angle number indication



Press CLEAR.

To disable the angle icon display on the TV

From the on-screen displays, set OSD to OFF. [29](#) [34](#)
Monitor the DVD display when you want to change the camera angle.

2 ANGLE



Press ANGLE or ▲ while the angle number appears on the TV screen.

Each time you press the ANGLE or ▲ button, the camera angle changes.

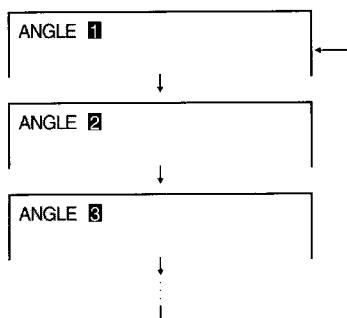
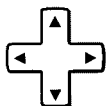

▼ : Cycles backwards

You can change the camera angle directly by pressing the number buttons corresponding to its angle number instead of using the ▲ / ▼ buttons.

Notes

- You can change the camera angle during still playback. The camera angle changes to the new setting when you resume normal playback.
- If you pause a picture immediately after changing the camera angle, the resumed playback picture may not use the new camera angle.

Selecting a Language

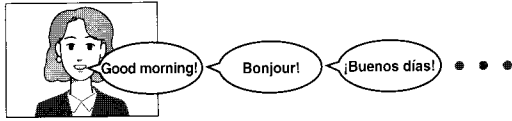

You can select a preferred language.

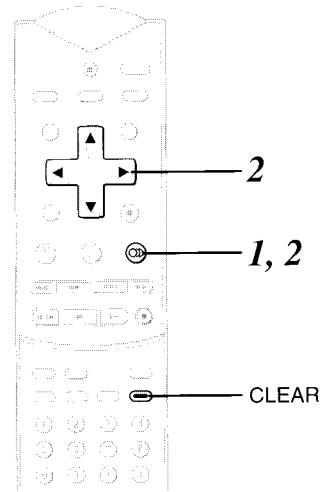

DVD

Selecting a Playback Audio Setting

You can select a preferred language and sound recording system from those included on the DVD video disc.

1 Press AUDIO during playback.



The current audio setting appears for about 3 seconds.

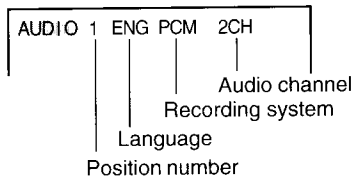

The abbreviation of the language appears instead of the language name. Refer to the list of languages and their abbreviations. [39]

To turn off the audio setting indication



Press CLEAR.

About recording systems

This DVD video player uses the Dolby Digital (AC-3) and PCM recording systems and cannot play DVD video discs recorded in any other recording system.

AC-3 5.1 Channel is displayed as "AC-3 6CH."

Note: Total channels available in AC-3 may vary from 1 – 6.

2 Press AUDIO or ▲ while the audio setting appears on the TV screen.



Each time you press the AUDIO or ▲ button, the audio settings included on the DVD video disc change.

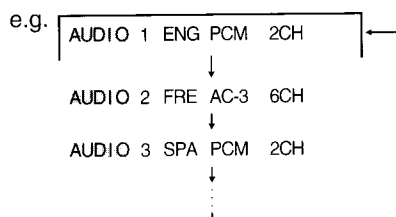

▼ : Cycles backwards

Notes

- Some discs allow you to change audio selections only via the disc menu. If this is the case, press the MENU button and choose the appropriate language from the selections on the disc menu.
 - When you turn on the DVD video player or replace a disc, player returns to the initial default setting. [31]
- When you select a sound which is not included on the disc, the DVD video player plays a prior sound programmed on the disc.

Output sound format (sampling frequency/quantization bit)

Discs	Sound recording system	Audio selection from the menu screen [29] [31] and output jacks on the rear panel					
		ANALOG		BITSTREAM		PCM	
		BITSTREAM/PCM jack	ANALOG jacks	BITSTREAM/PCM jack	ANALOG jacks	BITSTREAM/PCM jack	ANALOG jacks
DVD video discs	Dolby Digital	Bitstream	48 kHz/16 bit	Bitstream	48 kHz/16 bit	48 kHz/16 bit	48 kHz/16 bit
	Linear PCM	48 kHz/16 bit	48 kHz/16 bit	48 kHz/16 bit	48 kHz/16 bit	48 kHz/16 bit	48 kHz/16 bit
		48 kHz/20 bit	—	48 kHz/20 bit	48 kHz/16 bit	48 kHz/16 bit	48 kHz/16 bit
		48 kHz/24 bit	—	48 kHz/24 bit	48 kHz/16 bit	48 kHz/16 bit	48 kHz/16 bit
		96 kHz/16 bit	—	96 kHz/16 bit	48 kHz/16 bit	48 kHz/16 bit	48 kHz/16 bit
		96 kHz/20 bit	—	96 kHz/20 bit	48 kHz/16 bit	48 kHz/16 bit	48 kHz/16 bit
96 kHz/24 bit	—	96 kHz/24 bit	48 kHz/16 bit	48 kHz/16 bit	48 kHz/16 bit		
Audio CDs	Linear PCM 44.1 kHz/16 bit	44.1 kHz/16 bit	44.1 kHz/16 bit	44.1 kHz/16 bit	44.1 kHz/16 bit	44.1 kHz/16 bit	

Selecting Subtitles

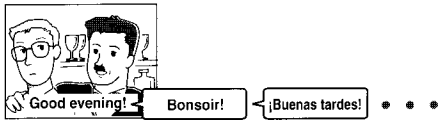

You can display subtitles on the TV screen and select a preferred subtitle language.

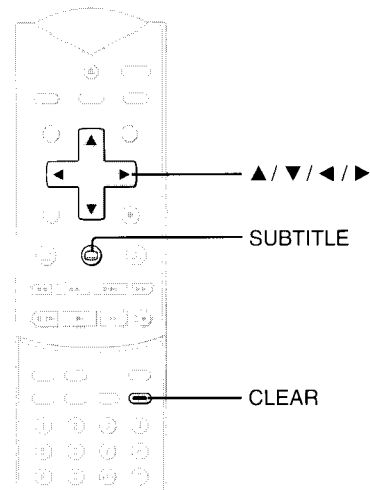

Turning Subtitles on or off

You can select whether to display subtitles or not.

1 **SUBTITLE** Press **SUBTITLE** during playback.

The current subtitle setting appears for about 3 seconds.

SUBTITLE 1 ENG ON

2 Press **◀** or **▶** while the subtitle setting appears on the TV screen, to select **ON** or **OFF**.

ON: Subtitles are displayed.

SUBTITLE 1 ENG ON

 Good evening! — Subtitles

OFF: Subtitles are not displayed.

SUBTITLE 1 ENG OFF

Selecting a Subtitle Language

You can select a subtitle language from those included on the DVD video disc.

1 **SUBTITLE** Press **SUBTITLE** during playback.

The current subtitle setting appears for about 3 seconds.

SUBTITLE 1 ENG ON
 |
 Language
 Position number

The abbreviation of the language appears instead of the language name. Refer to the list of languages and their abbreviations. [39](#)

2 **SUBTITLE** Press **SUBTITLE** or **▲** while the subtitle setting appears on the TV screen.

Each time you press the **SUBTITLE** or **▲** button, the subtitle languages included on the DVD video disc change.

e.g.

SUBTITLE 1 ENG ON
 ↓
 SUBTITLE 2 FRE ON
 ↓
 SUBTITLE 3 SPA ON
 ↓
 ...

▼: Cycles backwards

To turn off the subtitle setting indicator

CLEAR
 Press **CLEAR**.

Notes

- Some DVD video discs are set to display subtitles automatically, and you cannot turn them off even if you set the subtitle function to off.
- During some scenes, the subtitles may not appear immediately after you select ON.
- Some DVD video discs will allow you to make subtitle selections and turn subtitles on or off only via the disc menu.

Notes

- When you turn on the DVD video player or replace a disc, the player returns to the initial default setting. [36](#)
 When you select a subtitle language which is not included on the disc, the DVD video player plays a prior language programmed on the disc.
- During some scenes, the subtitles may not appear immediately after you change the subtitle language by pressing the **▲** / **▼** buttons.

Using the On-Screen Display

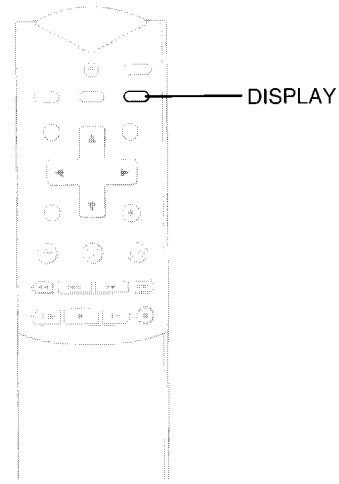

You can view information about a disc and its operational status on the TV screen.

DVD CD

Checking the Operational Status

You can view the current title number, track number, and total playing time of the disc on the TV screen.

DISPLAY



Press DISPLAY during stop.

Each time you press the DISPLAY button, the on-screen display changes as follows.

(DVD video disc)

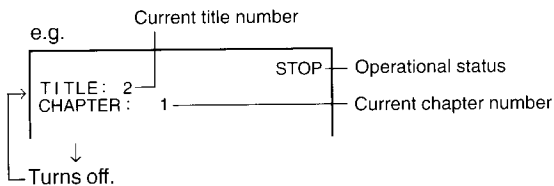

(Audio CD)

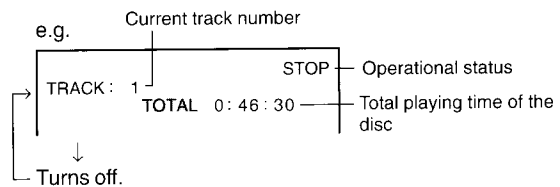

DVD CD

Checking the Remaining Time and Setting Status

You can view the elapsed time, remaining time, and setting status of the disc on the TV screen.

DISPLAY



Press DISPLAY during playback.

Each time you press the DISPLAY button, the on-screen display changes as follows.

(DVD video disc)

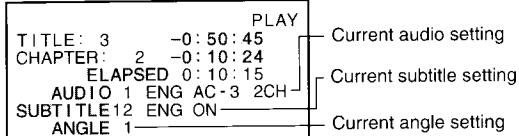
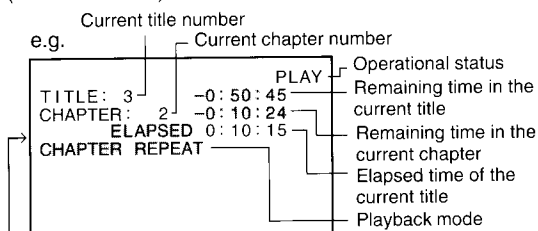

The abbreviation of the language (e.g. ENG) appears instead of the language name. Refer to the list of languages and their abbreviations. [39]

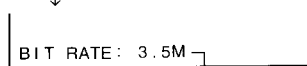

Data transfer rate (Mbit/s)
= Amount of picture, sound and subtitle data in the DVD video disc transferred per second.

The larger the value is, the more data processed, but this does not necessarily insure better picture quality.

Turns off.

(Audio CD)

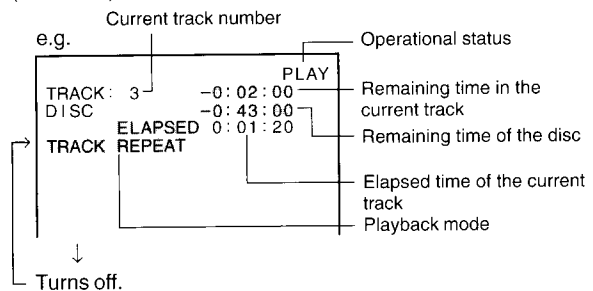

Customizing the Function Settings

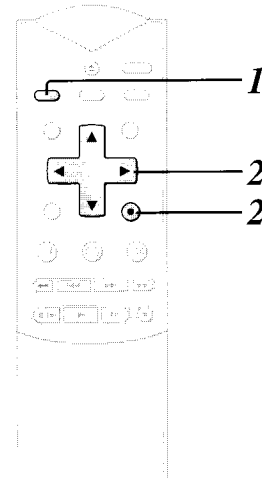
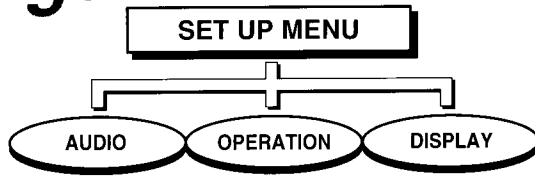

You can change the default settings to customize performance to your preference.

Displaying the SET UP MENU Screen

The SET UP MENU screen asks you to select a setting category from AUDIO, OPERATION and DISPLAY. Each selected category will provide you setting details via the succeeding screen.

1 **SETUP** Press **SETUP** during stop.
The SET UP MENU screen appears.

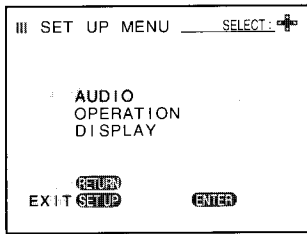

- The display language can be changed. Proceed to 35, "OSD LANGUAGE", via step 2 below.

2 Press **▲/▼** to select the category, then press **ENTER**.

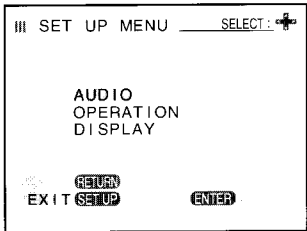

ENTER

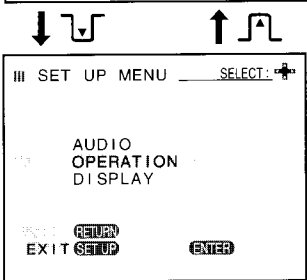
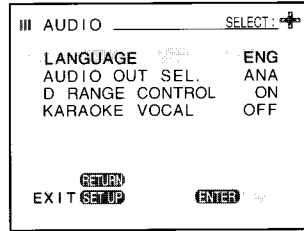

ENTER

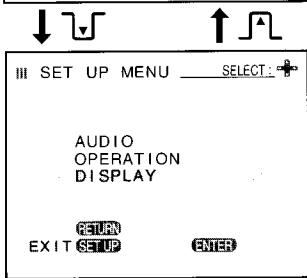
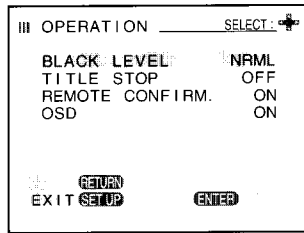

ENTER

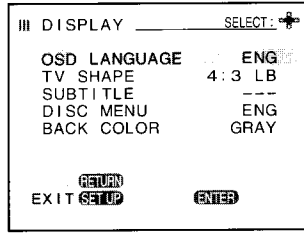

Notes

- The SET UP MENU screen disappears when you press the SETUP button.
- The SETUP button can work even during normal playback, however some operations may be inaccessible, and a message will appear. In this case, try again after playback is stopped.

AUDIO

Setting	Details	Page
LANGUAGE	To select a preferred language for the sound track.	31
AUDIO OUT SEL.	To select ANALOG, BITSTREAM or PCM according to your connection.	31
D RANGE CONTROL	To turn on or off a function that makes faint sounds easier to hear even if you lower the volume during late hours playback.	31
KARAOKE VOCAL	To turn on or off the vocal output during DVD KARAOKE disc playback.	32

OPERATION

Setting	Details	Page
BLACK LEVEL	To select the black level of playback pictures.	33
TITLE STOP	To turn on or off a feature that automatically stops playback after a title has been viewed.	33
REMOTE CONFIRM.	To turn on or off the confirmation beeper for each remote command received.	33
OSD	To turn on or off the operational status display (On-screen display) on the TV screen.	34

DISPLAY

Setting	Details	Page
OSD LANGUAGE	To select a preferred language for on-screen displays.	35
TV SHAPE	To select a picture size according to the aspect ratio of your TV.	35
SUBTITLE	To select a preferred language for subtitles.	36
DISC MENU	To select a preferred language for disc menus.	36
BACK COLOR	To select the background color for on-screen displays.	36

Customizing the Function Settings (continued)

AUDIO

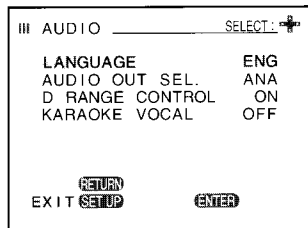

After you select AUDIO on the SET UP MENU screen 29, adjust to your preference.

Setting the Audio

3

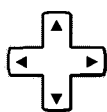

(Continued from page 29.)

Press to select the item, then press ENTER.

The setting screen of your selected item appears.



LANGUAGE

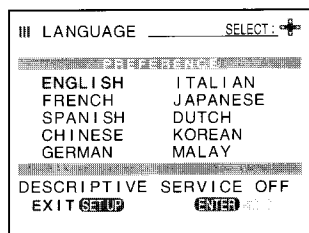

Select a preferred language by pressing , and then press ENTER.

You will return to the AUDIO screen.
→ If you do not make any other settings, proceed to step 4.

- Some DVD video discs contain special language track that describes the actions on-screen for visually impaired persons. When you set DESCRIPTIVE SERVICE to ON by pressing the AUDIO button, the DVD video player automatically plays this special feature.
- Some DVD video discs may be played in a different language than you selected, since it may be a prior language programmed on the disc.

AUDIO OUT SEL.

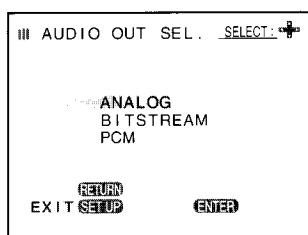

Select the output sound type according to your system connection.

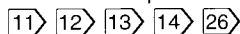

Select the output sound type ANALOG, BITSTREAM or PCM by pressing , and then press ENTER.

You will return to the AUDIO screen.
→ If you do not make any other settings, proceed to step 4.

D RANGE CONTROL

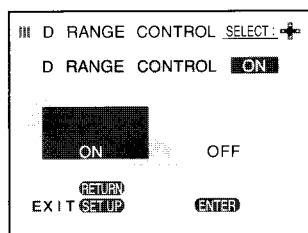

ON: Dynamic range is reduced.
OFF: Full dynamic range is maintained.



Select ON or OFF by pressing , and then press ENTER.

You will return to the AUDIO screen.
→ If you do not make any other settings, proceed to step 4.

- This function works only on playback of Dolby Digital (AC-3) recorded discs.
- The level of Dynamic Range Reduction may differ depending on the DVD video disc.

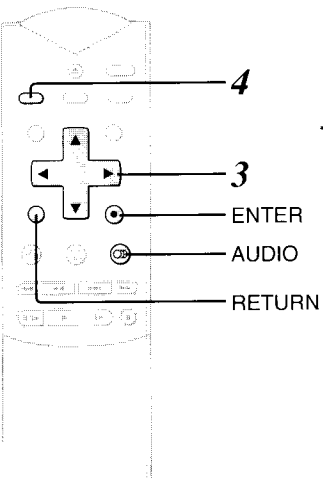

RETURN : If you press the RETURN button while a menu appears on the screen, you will return to the previous menu screen displayed.

DVD CD

KARAOKE VOCAL

DVD

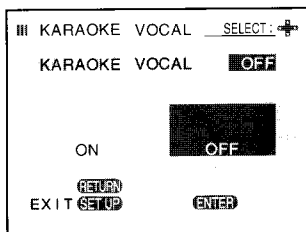

ON: The primary vocal is output when it is recorded on the disc.
OFF: The primary vocal is not output.



Select ON or OFF by pressing **◀/▶**, and then press ENTER.

You will return to the AUDIO screen.
 → If you do not make any other settings, proceed to step 4.

The vocal output feature is used during playback of Dolby Digital (AC-3, multi-channel) recorded DVD KARAOKE discs. This feature allows you to turn off vocal audio tracks, or restore them for background accompaniment.

4 **SETUP** **Press SETUP.**
 The menu screen disappears.

Customizing the Function Settings (continued)

OPERATION

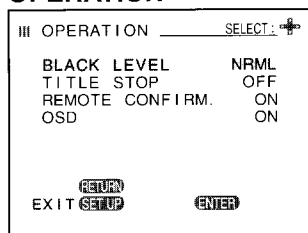

After you select OPERATION on the SET UP MENU screen [29], adjust to your preference.

Setting the Operation Modes

3



(Continued from page 29.)

Press ▲ / ▼ to select the item, then press ENTER.

The setting screen of your selected item appears.



BLACK LEVEL DVD

NORMAL: Standard black level.
ENHANCED: Expanded black level.

Select a preferred black level by pressing ◀/▶, and then press ENTER.

You will return to the OPERATION screen.
 → If you do not make any other settings, proceed to step 4.

TITLE STOP DVD

ON: Player stops after playback of a title is completed.
OFF: Player continues after playback of a title is completed.

Select ON or OFF by pressing ◀/▶, and then press ENTER.

You will return to the OPERATION screen.
 → If you do not make any other settings, proceed to step 4.

REMOTE CONFIRM. DVD CD

ON: Beeper sounds with each remote operation.
OFF: The beeper does not sound.

Select ON or OFF by pressing ◀/▶, and then press ENTER.

You will return to the OPERATION screen.
 → If you do not make any other settings, proceed to step 4.

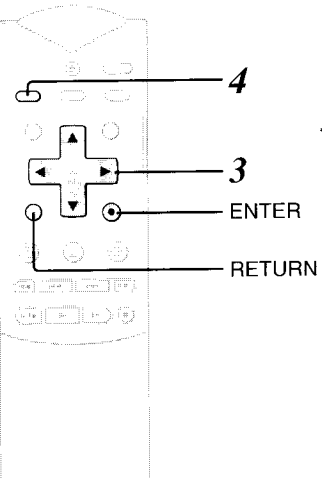



RETURN : If you press the RETURN button while a menu appears on the screen, you will return to the previous menu screen displayed.

DVD CD

OSD

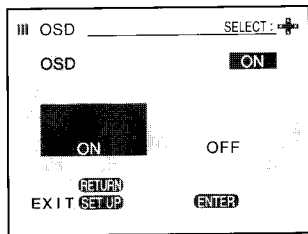
DVD CD



ON: Operational modes are displayed on-screen. (e.g. "PLAY", )
OFF: Operational modes are not displayed.



Select ON or OFF by pressing </>, and then press ENTER.

You will return to the OPERATION screen.
 → If you do not make any other settings, proceed to step 4.

4 **SETUP** **Press SETUP.**
 The menu screen disappears.

Customizing the Function Settings (continued)

DISPLAY

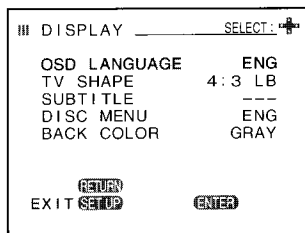

After you select DISPLAY on the SET UP MENU screen , adjust to your preference.

Setting the Displays

3

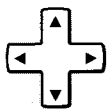

(Continued from page 29.)

Press **▲ / ▼** to select the item, then press **ENTER**.

The setting screen of your selected item appears.

ENTER



OSD LANGUAGE  

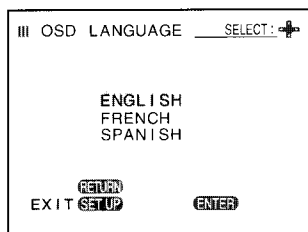

Select a preferred language by pressing **▲ / ▼**, and then press **ENTER**.

You will return to the DISPLAY screen.
→ If you do not make any other settings, proceed to step 4.

TV SHAPE 

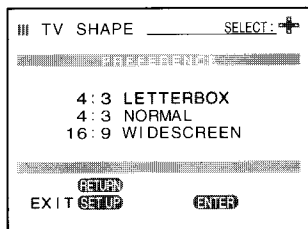

4:3 LETTERBOX: Select when a 4:3 TV is connected.
Displays theatrical images with masking bars above and below the picture.



4:3 NORMAL: Select when a 4:3 TV is connected.
Displays pictures cropped to fill your TV screen. Either or both sides of the picture are cut off.

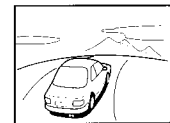

16:9 WIDESCREEN: Select when a 16:9 wide TV is connected.



Select your TV type by pressing **▲ / ▼**, and then press **ENTER**.

You will return to the DISPLAY screen.
→ If you do not make any other settings, proceed to step 4.

- The displayable picture size is preset on the DVD video disc. Therefore, the playback picture of some DVD video discs may not conform to the picture size you select.
- When you play DVD video discs recorded in the 4:3 picture size only, the playback picture always appears in the 4:3 picture size regardless of the TV shape setting.
- If you select 16:9 WIDE SCREEN and you own a 4:3 TV set, the DVD playback picture will be horizontally distorted during playback. Images will appear to be horizontally compressed. Always be sure that your TV shape conforms to the actual TV in use.

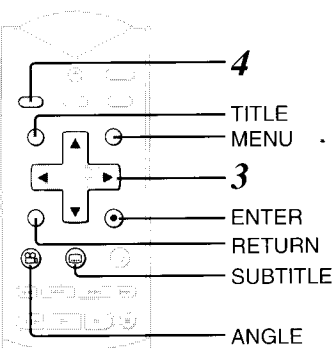

RETURN  : If you press the RETURN button while a menu appears on the screen, you will return to the previous menu screen displayed.

DVD CD

SUBTITLE

DVD

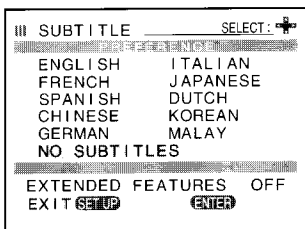

Select a preferred language by pressing **▲/▼/◀/▶**, and then press **ENTER**.

You will return to the DISPLAY screen.
→ If you do not make any other settings, proceed to step 4.

- Some DVD video discs contain special subtitles, an enhancement of closed captioning for hearing impaired persons. When you set EXTENDED FEATURES to "ON" by pressing the SUBTITLE button, the DVD video player automatically displays these special subtitles.
- Some DVD video discs may be set to display subtitles in a different language than you selected, since it may be a prior subtitle language programmed on the disc.
- Some DVD video discs allow you to change subtitle selections only via the disc menu. If this is the case, press the MENU button and choose the appropriate subtitle language from the selection on the disc menu.

DISC MENU

DVD

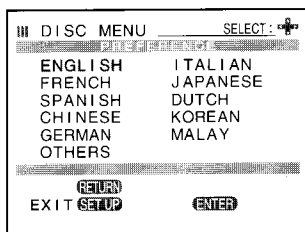

Select a preferred language by pressing **▲/▼/◀/▶**, and then press **ENTER**.

You will return to the DISPLAY screen.
→ If you do not make any other settings, proceed to step 4.

■ To select other languages:

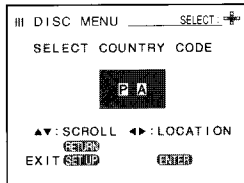

- 1) Select OTHERS and press the ENTER button.
- 2) Obtain the abbreviation of the preferred language from the list [39](#).
- 3) Select the first character by pressing the **▲/▼** buttons.
- 4) Press the **◀/▶** buttons to shift and select the second character by pressing the **▲/▼** buttons.
- 5) Press the ENTER button to return to the DISPLAY screen.

- Some DVD video discs may not include your pre-selected language. In this case, the DVD video player automatically displays disc menus consistent with the disc's initial language setting.

BACK COLOR

DVD CD

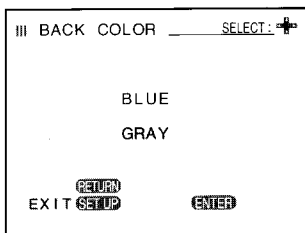

BLUE: Blue background.
GRAY: Gray background.



Select a preferred background color by pressing **▲/▼**, and then press **ENTER**.

You will return to the DISPLAY screen.
→ If you do not make any other settings, proceed to step 4.

Function Setup

4 **SETUP**  **Press SETUP.**
The menu screen disappears.

Setting the Parental Lock

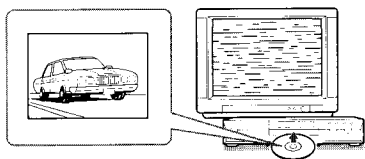

You can use the parental lock function only with DVD video discs equipped with the parental lock feature.

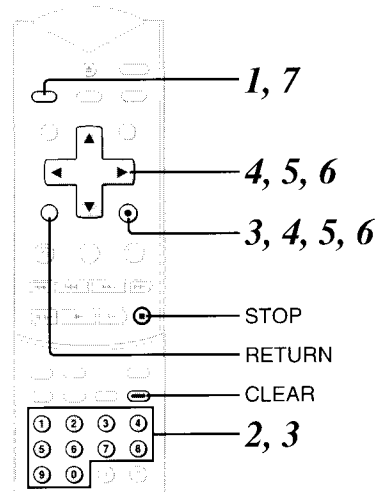

Setting the Parental Lock

DVD video discs equipped with the parental lock function are rated according to their content. The contents allowed by a parental lock level and the way a DVD video disc can be controlled may vary from disc to disc. For example, if the disc allowed you could edit out violent scenes unsuitable for children and replace them with more suitable scenes, or lock out playback of the disc altogether.

1 **Press SETUP during stop.**
The SET UP MENU appears on the TV screen.

2 **Press 9 twice.**
The following menu appears.

III PARENTAL LOCK
PRESET SECURITY CODE
[][][][]
PRESS [0] - [9]
RETURN ENTER
EXIT SETUP ENTER

3 **Press the number buttons to create a personal 4-digit security code, then press ENTER.**
e.g.

III PARENTAL LOCK SELECT: +
PARENTAL LOCK OFF
ON OFF
USAB

If you make a mistake before pressing the ENTER button, press the **CLEAR** button and enter your 4-digit security code again.

4 **Press </> to select ON, then press ENTER.**
The following menu appears.

III PARENTAL LOCK SELECT: +
COUNTRY USA
USA CAN
LEVEL8 LEVEL8
RETURN ENTER
EXIT SETUP ENTER

5 **Press </> to select the country whose standards were used to rate the DVD video disc, then press ENTER.**
The following menu appears.

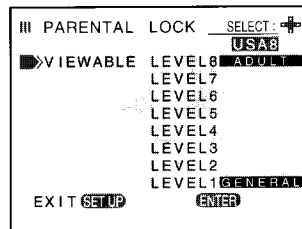

6 **Press ▲/▼ to select the parental lock level, then press ENTER.**
You cannot play DVD video discs rated higher than the level you selected unless you cancel the parental lock function. For example, when you select level 7, discs rated higher than level 7 are locked out and cannot be played.

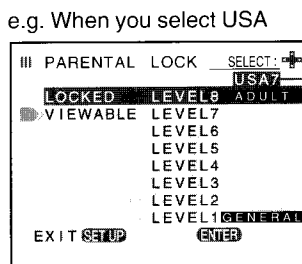

When you select CAN, "CAN7" appears instead.

The parental lock level is equivalent to the following USA movie ratings.

- LEVEL 7: NC-17 LEVEL 3: PG
- LEVEL 6: R LEVEL 1: G
- LEVEL 4: PG 13

The parental lock levels for "CAN" (Canada) are included for future use. Check the appropriate parental lock level when you buy a DVD video disc equipped with the parental lock feature in the future.

7 **Press SETUP.**
The SET UP MENU disappears.

RETURN : If you press the **RETURN** button while a menu appears on the screen, you will return to the previous screen displayed.

To change the parental lock level

You can change the parental lock level by following the steps in "Setting the Parental Lock."
In step 3, press the **number buttons** to enter your 4-digit security code, then continue to step 4.

If you make a mistake, press the **CLEAR** button and enter the correct 4-digit security code.

To change your 4-digit security code

You can change your 4-digit security code.

- 1 Follow steps 1 and 2 in "Setting the Parental Lock."
- 2 Press the **STOP** button four times and then the **ENTER** button while the security code menu appears on the TV screen.

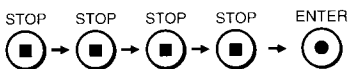

The 4-digit security code is cleared.

- 3 Press the **number buttons** to create a new 4-digit security code, then press the **ENTER** button.
- 4 Complete steps 4 to 7 in "Setting the Parental Lock."

To cancel the parental lock function

- 1 Follow steps 1 and 2 in "Setting the Parental Lock."
- 2 Press the **number buttons** to enter your 4-digit security code, then press the **ENTER** button.
If you make a mistake, press the **CLEAR** button and enter the correct 4-digit security code.
- 3 Press **◀/▶** to select OFF, then press the **ENTER** button.

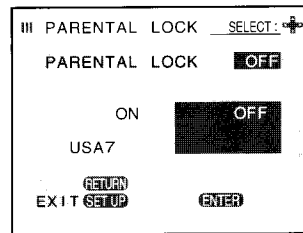

The SET UP MENU appears again.

- 4 Press the **SETUP** button.
The SET UP MENU disappears, and the parental lock function is canceled.

Note

DVD video discs may or may not respond to the parental lock settings. This is not a defect in the DVD video player.

Table of Languages

Table of Languages and Their Abbreviations

Abbreviation of the Language	Language	Abbreviation of the Language	Language	Abbreviation of the Language	Language	Abbreviation of the Language	Language
---	No alternate language	EO	Esperanto	LN	Lingala	SL	Slovenian
CHI	Chinese	ET	Estonian	LO	Laotian	SM	Samoan
DUT	Dutch	EU	Basque	LT	Lithuanian	SN	Shona
ENG	English	FA	Persian	LV	Latvian, Lettish	SO	Somali
FRE	French	FI	Finnish	MG	Malagasy	SQ	Albanian
GER	German	FJ	Fiji	MI	Maori	SR	Serbian
ITA	Italian	FO	Faroese	MK	Macedonian	SS	Siswati
JPN	Japanese	FY	Frisian	ML	Malayalam	ST	Sesotho
KOR	Korean	GA	Irish	MN	Mongolian	SU	Sundanese
MAY	Malay	GD	Scottish Gaelic	MO	Moldavian	SV	Swedish
SPA	Spanish	GL	Galician	MR	Marathi	SW	Swahili
AA	Afar	GN	Guarani	MT	Maltese	TA	Tamil
AB	Abkhazian	GU	Gujarati	MY	Burmese	TE	Telugu
AF	Afrikaans	HA	Hausa	NA	Nauru	TG	Tajik
AM	Amharic	HI	Hindi	NE	Nepali	TH	Thai
AR	Arabic	HR	Croatian	NO	Norwegian	TI	Tigrinya
AS	Assamese	HU	Hungarian	OC	Occitan	TK	Turkmen
AY	Aymara	HY	Armenian	OM	(Afan) Oromo	TL	Tagalog
AZ	Azerbaijani	IA	Interlingua	OR	Oriya	TN	Setswana
BA	Bashkir	IE	Interlingue	PA	Panjabi	TO	Tongan
BE	Belorussian	IK	Inupiak	PL	Polish	TR	Turkish
BG	Bulgarian	IN	Indonesian	PS	Pashto, Pushto	TS	Tsonga
BH	Bihari	IS	Icelandic	PT	Portuguese	TT	Tatar
BI	Bislama	IW	Hebrew	QU	Quechua	TW	Twí
BN	Bengali, Bangla	JI	Yiddish	RM	Rhaeto-Romance	UK	Ukrainian
BO	Tibetan	JW	Javanese	RN	Kirundi	UR	Urdu
BR	Breton	KA	Georgian	RO	Rumanian	UZ	Uzbek
CA	Catalan	KK	Kazakh	RU	Russian	VI	Vietnamese
CO	Corsican	KL	Greenlandic	RW	Kinyarwanda	VO	Volapük
CS	Czech	KM	Cambodian	SA	Sanskrit	WO	Wolof
CY	Welsh	KN	Kannada	SD	Sindhi	XH	Xhosa
DA	Danish	KS	Kashmiri	SG	Sango	YO	Yoruba
DZ	Bhutani	KU	Kurdish	SH	Serbo-Croatian	ZU	Zulu
EL	Greek	KY	Kirghiz	SI	Singhalese		
		LA	Latin	SK	Slovak		

Notes on Discs

On Handling Discs

- Do not touch the playback side of the disc.

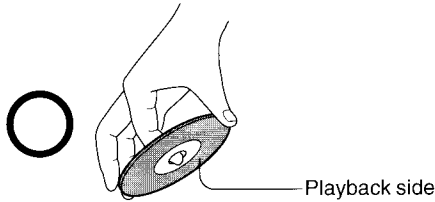

- Do not attach paper or tape to discs.



On Cleaning Discs

- Fingerprints and dust on the disc cause picture and sound deterioration. Wipe the disc from the center outwards with a soft cloth. Always keep the disc clean.

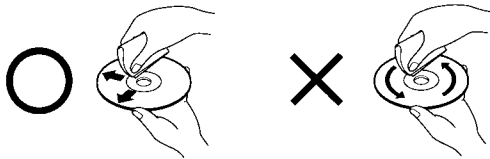

- If you cannot wipe off the dust with a soft cloth, wipe the disc lightly with a slightly moistened soft cloth and finish with a dry cloth.
- Do not use any type of solvent such as thinner, benzene, commercially available cleaners or antistatic spray for vinyl LPs. It may damage the disc.



On Storing Discs

- Do not store discs in a place subject to direct sunlight or near heat sources.
- Do not store discs in places subject to moisture and dust such as a bathroom or near a humidifier.
- Store discs vertically in a case. Stacking or placing objects on discs outside of their case may cause warping.

About This Owner's Manual



This owner's manual explains the basic instructions of this DVD video player. Some DVD video discs are produced in a manner that allows specific or limited operation during playback. As such, the DVD video player may not respond to all operating commands. This is not a defect in the DVD video player. Refer to instruction notes of discs.

“” may appear on the TV screen during operation.

White “” means that the operation is not permitted by the DVD video player; red “” by the operation is not permitted by the disc.

Playable Discs



This DVD video player can play the following discs.

	Disc mark	Contents	Disc size	Maximum playback time
DVD video discs		Audio + Video (moving pictures)	12 cm	Approx. 4 hours (single sided disc) Approx. 8 hours (double sided disc)
			8 cm	Approx. 80 minutes (single sided disc) Approx. 160 minutes (double sided disc)
Audio CDs		Audio	12 cm	74 minutes
			8 cm (CD single)	20 minutes

You cannot play discs other than those listed above.

This DVD video player uses the NTSC color system, and cannot play DVD video discs recorded in any other color system (PAL, SECAM, etc.).

Notes on Region Numbers

The region number of this DVD video player is 1. If region numbers, which stand for their playable area, are printed on your DVD video disc and you do not find  or , disc playback will not be allowed by the player. (In this case, the DVD video player displays the message.)

Notes on Copyright

It is forbidden by law to copy, broadcast, show, broadcast on cable, play in public, and rent copyrighted material without permission.

DVD video discs are copy protected, and any recordings made from these discs will be distorted.

This product incorporates copyright protection technology that is protected by method claims of certain U.S. patents and other intellectual property rights owned by Macrovision Corporation and other rights owners. Use of this copyright protection technology must be authorized by Macrovision Corporation, and is intended for home and other limited viewing uses only unless otherwise authorized by Macrovision Corporation. Reverse engineering or disassembly is prohibited.

Before Calling Service Personnel

Check the following guide for the possible cause of a problem before contacting service.

Symptoms and Correction

Symptom	Cause	Correction	Page
No power.	<ul style="list-style-type: none"> The power plug is disconnected. 	<ul style="list-style-type: none"> Connect the power plug securely into the wall outlet. 	11, 12
No picture.	<ul style="list-style-type: none"> The TV is not set to receive DVD signal output. 	<ul style="list-style-type: none"> Select the appropriate video input mode on the TV so the picture from the DVD video player appears on the TV screen. 	15
	<ul style="list-style-type: none"> The video cable is not connected securely. 	<ul style="list-style-type: none"> Connect the video cable securely into the appropriate jacks. 	11, 12, 13, 14
No sound.	<ul style="list-style-type: none"> The equipment connected with the audio cable is not set to receive DVD signal output. 	<ul style="list-style-type: none"> Select the correct input mode of the audio receiver so you can listen to the sound from the DVD video player. 	15
	<ul style="list-style-type: none"> The audio cables are not connected securely. 	<ul style="list-style-type: none"> Connect the audio cable securely into the appropriate jacks. 	11, 12, 13, 14
	<ul style="list-style-type: none"> The power of the equipment connected with the audio cable is turned off. 	<ul style="list-style-type: none"> Turn on the equipment connected with the audio cable. 	–
	<ul style="list-style-type: none"> The setting of output sound type is not correct. 	<ul style="list-style-type: none"> Set the audio setting correctly. 	29, 31
The playback picture has occasional distortion.	<ul style="list-style-type: none"> The disc is dirty. 	<ul style="list-style-type: none"> Eject the disc and clean it. 	40
	<ul style="list-style-type: none"> It is in fast forward or fast reverse playback. 	<ul style="list-style-type: none"> Sometimes a small amount of picture distortion may appear. This is not a malfunction. 	–
Brightness is unstable or noises are produced on playback pictures.	<ul style="list-style-type: none"> The effect of copy protection. 	<ul style="list-style-type: none"> Connect the DVD video player directly to the TV. Avoid connecting the DVD video player to a VCR or TV/VCR combination. 	11
The DVD video player does not start playback.	<ul style="list-style-type: none"> No disc is inserted. 	<ul style="list-style-type: none"> Insert a disc. (Check that the DVD or audio CD indicator in the DVD display is lit.) 	8
	<ul style="list-style-type: none"> An unplayable disc is inserted. 	<ul style="list-style-type: none"> Insert a playable disc. (Check the disc type and color system.) 	40
	<ul style="list-style-type: none"> The disc is placed upside down. 	<ul style="list-style-type: none"> Place the disc with the playback side down. 	15
	<ul style="list-style-type: none"> The disc is not placed within the guide. 	<ul style="list-style-type: none"> Place the disc correctly inside the guide on the disc tray. 	15
	<ul style="list-style-type: none"> The disc is dirty. 	<ul style="list-style-type: none"> Clean the disc. 	40
	<ul style="list-style-type: none"> The parental lock function is set. 	<ul style="list-style-type: none"> Cancel the parental lock function or change the parental lock level. 	37, 38
Buttons do not work.	<ul style="list-style-type: none"> Power supply fluctuations or other abnormalities such as static electricity may interrupt correct operations. 	<ul style="list-style-type: none"> Turn the power on or off with the POWER button. Or disconnect the power plug and insert it into the wall outlet again. 	–
The remote control does not work properly.	<ul style="list-style-type: none"> The remote control is not pointed at the remote sensor of the DVD video player. 	<ul style="list-style-type: none"> Point the remote control at the remote sensor of the DVD video player. 	10
	<ul style="list-style-type: none"> The remote control is too far from the DVD video player. 	<ul style="list-style-type: none"> Operate the remote control within about 7 m. 	10
	<ul style="list-style-type: none"> The batteries in the remote control are exhausted. 	<ul style="list-style-type: none"> Replace the batteries with new ones. 	10

Specifications

DVD Video Player / Outputs / Supplied Accessories

[DVD Video Player]

Power supply	120 V AC, 60 Hz
Power consumption	18 W
Mass	3.3 kg
External dimensions	430 × 81 × 300 mm (W/H/D)
Signal system	Standard NTSC
Laser	Semiconductor laser, wavelength 650 nm
Frequency range (digital audio)	DVD linear sound : 48 kHz sampling 4 Hz to 22 kHz 96 kHz sampling 4 Hz to 44 kHz Audio CD : 4 Hz to 20 kHz
Signal-to-noise ratio (digital audio)	More than 110 dB
Audio dynamic range (digital audio)	More than 106 dB
Harmonic distortion (digital audio)	Less than 0.001 %
Wow and flutter	Below measurable level (less than ±0.001 % (W.PEAK))
Operating conditions	Temperature: 5 °C to 35 °C, Operation status: Horizontal

[Outputs]

Video output	1.0 V (p-p), 75 Ω, negative sync., pin jack × 1
S video output	(Y) 1.0 V (p-p), 75 Ω, negative sync., Mini DIN 4-pin × 1 (C) 0.286 V (p-p), 75 Ω
Audio output (digital audio)	0.5 V (p-p), 75 Ω, pin jack × 1
Audio output (analog audio)	2.0 V (rms), 220 Ω, pin jacks (L, R) × 1

[Supplied Accessories]

S video cable	1
Audio/video cable	1
Remote control (SE-R0001)	1
Batteries (AAA)	2

- Designs and specifications are subject to change without notice.

LIMITED WARRANTY DVD VIDEO PLAYER

Toshiba America Consumer Products, Inc. ("TACP"), Toshiba Hawaii ("THI") and Toshiba Canada Limited ("TCL") make the following limited warranties. These limited warranties extend to original purchaser or any person receiving this set as a gift from the original purchaser and to no other purchaser or transferee.

Limited Ninety (90) Day Warranty

TACP/THI warrant this product against defects in materials or workmanship for a period of ninety (90) days after the date of original retail purchase. During this period, TACP/THI will repair a defective product or part without charge to you. You must deliver the entire product to a TACP/THI Authorized Service Station. You are responsible for all transportation and insurance charges for the unit to and from the Authorized Service Station. If you live in the U.S.A. you may, at your option, return your DVD Unit to:

Toshiba America Consumer Products Inc.
Returns Center
1420C Toshiba Dr.
Lebanon, TN 37087

Upon receipt we will, at our option, exchange the DVD Unit with a new or refurbished unit. **Canadian consumers are requested to contact TCL. In Hawaii consumers are requested to contact THI.**

Limited One (1) Year Warranty

TACP/THI further warrant the parts in this product against defects in materials or workmanship for a period of one (1) year after the date of original retail purchase. During this period, TACP/THI will replace a defective part without charge to you, except that if a defective part is replaced after ninety (90) days from the date of the original retail purchase you pay labor charges involved in the replacement. You must also deliver the entire product to a TACP/THI Authorized Service Station. You are responsible for all transportation and insurance charges for the unit to and from the Authorized Service Station. If you live in the U.S.A. you may, at your option, return your DVD Unit to:

Toshiba America Consumer Products Inc.
Returns Center
1420C Toshiba Dr.
Lebanon, TN 37087

Upon receipt we will, at our option, exchange the DVD Unit with a new or refurbished unit. **Canadian Consumers are requested to contact TCL. In Hawaii consumers are requested to contact THI.**

Rental Units

The warranty for rental units begin with the first rental or thirty (30) days from the date of shipment to the rental firm, whichever comes first.

How to Obtain Warranty Service

- (1) Refer to the troubleshooting guide in your owner's manual. This check list may solve your problem.
- (2) In the U.S.A., only call the TACP toll free number 800-631-3811, or if in Hawaii or Canada see listing below within (30) days after you find a defective product or part.
- (3) Arrange for the delivery of the product to the TACP/THI/TCL Authorized Service Station or TACP Return Center. Products shipped to the Service Station must be insured and safely and securely packed, preferably in the original shipping carton, and a letter explaining the defect and also a copy of the bill of sale or other proof of purchase must be enclosed.

In the Continental United States contact:



In Hawaii contact:

Toshiba Hawaii Inc.
327 Kamakee Street
Honolulu, HA 96814
(808)-521-5377

In Canada contact:

Consumer Electronics Group
191 McNabb Street
Markham, Ontario L3R 8H2
(905)-470-5400

Consumer Electronics Group
22171 Fraserwood Way
Richmond, B.C. V6W 1J5
(604)-303-2500

Consumer Electronics Group
1643 North Service Road
Droval, QC H9P 1J1
(514)-856-4100

All warranties implied by state law, including the implied warranties of merchantability and fitness for a particular purpose, are expressly limited to the duration of the limited warranties set forth above. With the exception of any warranties implied by state law as hereby limited, the foregoing warranty is exclusive and in lieu of all other warranties, guarantees, agreements and similar obligations of manufacturer or seller with respect to the repair or replacement of any parts. In no event shall TACP/THI be liable for consequential or incidental damages.

No person, agent, distributor, dealer or company is authorized to change, modify or extend the terms of these warranties in any manner whatsoever. The time within which an action must be commenced to enforce any obligation of TACP/THI arising under the warranty or under any statute, or law of the United States or any state thereof, is hereby limited to ninety (90) days from the date you discover or should have discovered, the defect. This limitation does not apply to implied warranties arising under state law.

This warranty gives you specific legal rights and you may also have other rights which may vary from state to state. Some states do not allow limitation on how long an implied warranty lasts, when an action may be brought, or the exclusion or limitation of incidental or consequential damages, so the above provisions may not apply to you.

ATTENTION CANADIAN CONSUMERS:

Canadian consumers are requested to complete the special Canadian "Warranty Registration Form" enclosed, and forward this completed form with a copy of bill of sale to TOSHIBA OF CANADA to "Register and Validate" their warranty. Product must be purchased from an Authorized Canadian Dealer. Products purchased in the U.S.A. and used in Canada are not covered by these warranties.

IMPORTANT: PACKING AND SHIPPING INSTRUCTION

When you send the product to a Service Station, you must use the original carton box and packing material, then insert the original carton box containing the unit into another carton using more packing material.

Commercial Units

Products sold and used for commercial use have a limited ninety (90) day warranty for all parts and labor.

Owner's Manual

You should read the owner's manual thoroughly before operating this product. You should complete and mail the enclosed Demographic card within ten (10) days after you, or the person who has given you this product as a gift, purchased this product. This is one way to enable TACP to provide you with better customer service and improved products. Failure to return the card will not affect your rights under this warranty.

Your Responsibility

The above warranties are subject to the following conditions:

- (1) You must retain your bill of sale or provide other proof of purchase.
- (2) You must notify a TACP/THI/TCL /Authorized Service Station within thirty (30) days after you discover a defective product or part.
- (3) All warranty servicing of this product must be made by a TACP/THI/TCL Authorized Service Station.
- (4) U.S.A. warranties are effective only if the product is purchased and operated in the U.S.A. or Puerto Rico.
- (5) Labor service charges for set installation. Set up, adjustment of customer controls and installation or repair of antenna systems are not covered by this warranty. Reception problems caused by inadequate antenna systems are your responsibility.
- (6) Warranties extend only to defects in materials or workmanship as limited above and do not extend to any product or parts which have been lost or discarded by you or to damage to products or parts caused by misuse, accident, damage caused by Acts of God, such as lightning or fluctuations in electric power, improper installation, improper maintenance or use in violation of instructions furnished by us; or to units which have been altered or modified without authorization of TACP/THI/TCL or to damage to products or part thereof which have had the serial number removed, altered, defaced or rendered illegible.
- (7) Should you elect to return your DVD Unit to TACP after the ninety (90) days and within one (1) year, or after the warranty period has expired: Call (800)-631-3811 to receive information concerning an exchange price. Payment must be enclosed with product in the form of a certified check or money order including reason for return.
- (8) Physically damaged DVD Units are not acceptable for repair or exchange whether in or out of warranty and will be returned as received.

TOSHIBA

Printed in Japan