

TOSHIBA



DVD VIDEO PLAYER SD-K741SU

OWNER'S MANUAL



Introduction 2

Connections 18

Basic playback 24

Advanced playback 32

Function setup 56

Others 64

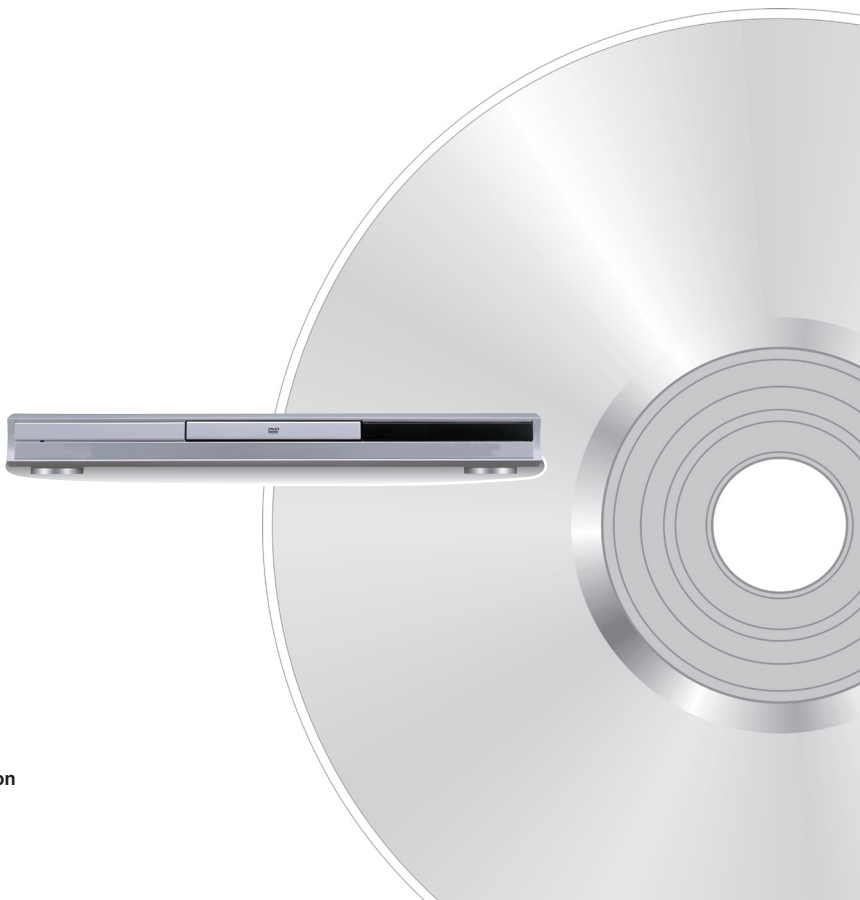

SAFETY PRECAUTIONS

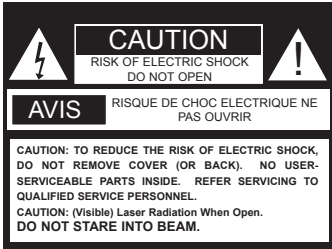

The lightning flash with arrowhead symbol, within an equilateral triangle, is intended to alert the user to the presence of uninsulated "dangerous voltage" within the product's enclosure that may be of sufficient magnitude to constitute a risk of electric shock to persons.



The exclamation point within an equilateral triangle is intended to alert the user to the presence of important operating and maintenance (servicing) instructions in the literature accompanying the appliance.



The symbol for CLASS II (Double Insulation)

WARNING: TO REDUCE THE RISK OF FIRE OR ELECTRIC SHOCK, DO NOT EXPOSE THIS APPLIANCE TO RAIN OR MOISTURE. DANGEROUS HIGH VOLTAGE ARE PRESENT INSIDE THE ENCLOSURE. DO NOT OPEN THE CABINET. REFER SERVICING TO QUALIFIED PERSONNEL ONLY.

CAUTION: TO PREVENT ELECTRIC SHOCK, MATCH WIDE BLADE OF PLUG TO WIDE SLOT, FULLY INSERT.

CAUTION: This Digital Video Disc Player employs a Laser System. To ensure proper use of this product, please read this owner's manual carefully and retain for future reference. Should the unit require maintenance, contact an authorized service location.

Use of controls or adjustments or performance of procedures other than those specified herein may result in hazardous radiation exposure.

To prevent direct exposure to laser beam, do not try to open the enclosure. Visible and invisible laser radiation when open and interlocks defeated. DO NOT STARE INTO BEAM.

FCC NOTICE: This equipment has been tested and found to comply with the limits for Class B digital device, pursuant to part 15 of the FCC Rule. These limits are designed to provide reasonable protection against harmful interference in a residential installation.

This equipment generates, uses, and can radiate radio frequency energy and, if not installed and used in accordance with the instructions, may cause harmful interference to radio communications.

However, there is no guarantee that interference will not occur in a particular installation.

If this equipment does cause harmful interference to radio or television reception, which can be determined by turning the equipment off and on, the user is encouraged to try to correct the interference by one or more of the following measures:

- Reorient or relocate the receiving antenna.
- Increase the separation between the equipment and receiver.
- Connect the equipment into an outlet on a circuit different from that of which the receiver is connected.
- Consult the dealer or an experienced radio/TV technician for help.

Changes or modifications made to this equipment, not expressly approved by Toshiba, or parties authorized by Toshiba, could void the user's authority to operate the equipment.

The instructions shall state that an ALL-POLE MAINS SWITCH with a contact separation of at least 3 mm in each pole shall be incorporated in the electrical installation of the building.

CAUTION: These servicing instructions are for use by qualified service personnel only. To reduce the risk of electric shock do not perform any servicing other than that contained in the operating instructions unless you are qualified to do so.

In the spaces provided below, record the Model and Serial No. Located on the rear panel of your DVD video player.

Model No. _____ Serial No. _____

Retain this information for future reference.

Location of the required label

THIS PRODUCT COMPLIES WITH DHHS RULE 21 SUBCHAPTER J PARTS 1040-10 AND 1040-11 AT DATE OF MANUFACTURED .
THIS DEVICE COMPLIES WITH PART 15 OF THE FCC RULES. OPERATION IS SUBJECT TO THE FOLLOWING TWO CONDITIONS: (1) THIS DEVICE MAY NOT CAUSE HARMFUL INTERFERENCE, AND (2) THIS DEVICE MUST ACCEPT ANY INTERFERENCE RECEIVED, INCLUDING INTERFERENCE THAT MAY CAUSE UNDESIRABLE OPERATION.

TOSHIBA CORPORATION
1-1, SHIBAURA 1-CHOME, MINATO-KU,
TOKYO 105-8001, JAPAN

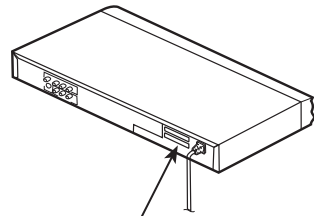

MANUFACTURED

SERIAL NO.

Be aware that this equipment is still powered even after the ON/STANDBY indicator turns off (standby mode) by pressing the ON/STANDBY button. To disconnect this equipment completely from the main power, pull out the power plug from the wall outlet.

IMPORTANT SAFETY INSTRUCTIONS

CAUTION: PLEASE READ AND OBSERVE ALL WARNINGS AND INSTRUCTIONS GIVEN IN THIS OWNER'S MANUAL AND THOSE MARKED ON THE UNIT. RETAIN THIS BOOKLET FOR FUTURE REFERENCE.

This set has been designed and manufactured to assure personal safety. Improper use can result in electric shock or fire hazard. The safeguards incorporated in this unit will protect you if you observe the following procedures for installation, use and servicing. This unit is fully transistorized and does not contain any parts that can be repaired by the user.

DO NOT REMOVE THE CABINET COVER, OR YOU MAY BE EXPOSED TO DANGEROUS VOLTAGE. REFER SERVICING TO QUALIFIED SERVICE PERSONNEL ONLY.

1. Read these instructions.
2. Keep these instructions.
3. Heed all warnings.
4. Follow all instructions.
5. Do not use this apparatus near water.
6. Clean only with dry cloth.

7. Do not block any ventilation openings. Install in accordance with the manufacturer's instruction.
8. Do not install near any heat sources such as radiators, heat registers, stove, or other apparatus (including amplifiers) that produce heat .
9. Do not defeat the safety purpose of the polarized or grounding-type plug. A polarized plug has two blades with one wider than the other. A grounding type plug has two blades and a third grounding prong. The wide blade or the third prong are provided for your safety. If the provided plug does not fit into your outlet, consult an electrician for replacement of the obsolete outlet.
10. Protect the power cord from being walked on or pinched particularly at plugs, convenience receptacles, and the point where they exit from the apparatus.
11. Only use attachments/accessories specified by the manufacturer.
12. Use only with the cart, stand, tripod, bracket, or table specified by the manufacturer, or sold with the apparatus. When a cart is used, use caution when moving the cart/apparatus combination to avoid injury from tip-over.



IMPORTANT SAFETY INSTRUCTIONS

13. Unplug this apparatus during lightning storms or when unused for long periods of time.

14. Refer all servicing to qualified service personnel. Servicing is required when the apparatus has been damaged in any way, such as power-supply cord or plug is damaged, liquid has been spilled or objects have fallen into the apparatus, the apparatus has been exposed to rain or moisture, does not operate normally, or has been dropped.

ADDITIONAL SAFETY INSTRUCTIONS

15. When you use headphones, keep the volume at a moderate level. If you use the headphones continuously with high volume sound, it may cause hearing damage.

16. Do not overload wall outlets; extension cords, or integral convenience receptacles as this can result in a risk of fire or electric shock.

17. The apparatus shall not be exposed to dripping or splashing liquids. Do not place objects such as vases filled with liquid on top of the apparatus.

18. Keep your fingers well clear of the disc tray as it is closing. Neglecting to do so may cause serious personal injury.

19. Do not place a heavy object on or step on the apparatus. The object may fall, causing serious personal injury and serious damage to the apparatus.

20. Do not use a cracked, deformed, or repaired disc. These discs are easily broken and may cause serious personal injury and apparatus malfunction.

21. If the apparatus should smoke or smell, immediately disconnect the power cord from the wall outlet. Wait until the smoke or smell stops, then ask your dealer for a check and repair. Neglecting to do so may cause fire.

22. While it is thundering, do not touch the connecting cables or the apparatus.

23. The apparatus includes lead, an ingredient of solder used on the PCB, which is a harmful substance to human and the environment. When disposing of this apparatus, follow the rules and regulations in your area.

Precautions

Notes on handling

- When shipping the DVD video player, the original shipping carton and packing materials come in handy. For maximum protection, repack the units as it was originally packed at the factory. Take care not to give it a shock or shake when carrying.
- Do not use volatile liquids, such as insect spray, near the DVD video player. Do not leave rubber or plastic products in contact with the DVD video player for a long time. They will leave marks on the finish.
- The top and rear panels of the DVD video player may become warm after a long period of use. This is not a malfunction.
- When the DVD video player is not in use, be sure to remove the disc and turn off the power.
- If you do not use the DVD video player for a long period, the unit may not function properly in the future. Turn on and use the DVD video player occasionally.

Notes on locating

- Place the DVD video player on a level surface. Do not use it on a shaky or unstable surface such as a wobbling table or inclined stand. The loaded disc may come off the proper position and cause damage to the DVD video player.
- When you place this DVD video player near a TV, radio, or VCR, the playback picture may become poor and the sound may be distorted. In this case, place the DVD video player away from the TV, radio, or VCR.

Notes on cleaning

Use a soft, dry cloth for cleaning

- For stubborn dirt, soak the cloth in a weak detergent solution, wring well and wipe. Use a dry cloth to wipe it dry.
- Do not use any type of solvent, such as thinner and benzene, as they may damage the surface of the DVD video player.
- If you use a chemical saturated cloth to clean the unit, follow that product's instructions.

Notes on moisture condensation

Moisture condensation damages the DVD video player. Please read the following carefully.

Moisture condensation occurs, for example, when you pour a cold drink into a glass on a warm day. Drops of water form on the outside of the glass. In the same way, moisture may condense on the optical pick-up lens inside this unit, one of the most crucial internal parts of the DVD video player.

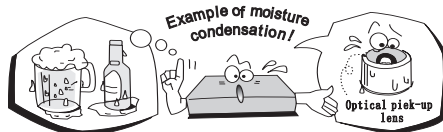

■ **Moisture condensation occurs during the following cases.**

- When you bring the DVD video player directly from a cold place to a warm place.
- When you use the DVD video player in a room where you just turned on the heater, or a place where the cold wind from the air conditioner directly hits the unit.
- In summer, when you use the DVD video player in a hot and humid place just after you move the unit from an air conditioned room.
- When you use the DVD video player in a humid place.

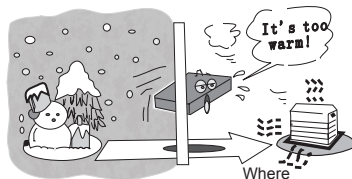

■ **Do not use the DVD video player where moisture condensation may occur.**

If you use the DVD video player in such a situation, it may damage discs and internal parts. Remove the disc, connect the power cord of the DVD video player to the wall outlet, turn on the DVD video player, and leave it for two or three hours. After two or three hours, the DVD video player will have warmed up and the moisture condensation may evaporate.

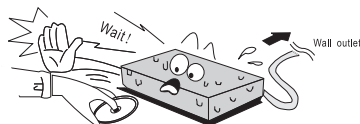

Notes on discs

On handling discs

- Do not touch the playback side of the disc.

YES

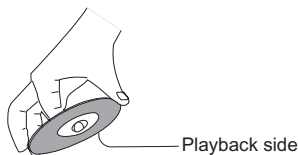

- Do not attach paper or tape to discs.

NO



On cleaning discs

- Fingerprints and dust on the disc cause picture and sound deterioration. Wipe the disc from the center outwards with a soft cloth. Always keep the disc clean.

YES



NO



- Do not use any type of solvent such as thinner, benzene, commercially available cleaners or antistatic spray for vinyl LPs. It may damage the disc.

On storing discs

- Do not store discs in a place subject to direct sunlight or near heat sources.
- Do not store discs in places subject to moisture and dust such as a bathroom or near a humidifier.
- Store discs vertically in a case. Stacking or placing objects on discs outside their case may cause warping.

Structure of disc contents

Normally, DVD video discs are divided into titles, and the titles are sub-divided into chapters. VIDEO CDs, and audio CDs are divided into tracks.

DVD video disc

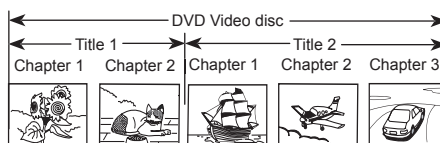

VIDEO CD/audio CD

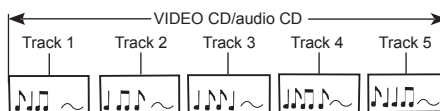

Each title, chapter or track is assigned a number, which is called "title number", "chapter number" or "track number" respectively.

There may be discs that do not have these numbers.

Notes on copyright

It is forbidden by law to copy, broadcast, show, broadcast on cable, play in public, and rent copyrighted material without permission.

DVD video discs are copy protected, and any recordings made from these discs will be distorted.

This product incorporates copyright protection technology that is protected by method claims of certain U.S. patents and other intellectual property rights owned by Macrovision Corporation and other rights owners. Use of this copyright protection technology must be authorized by Macrovision Corporation, and is intended for home and other limited viewing uses only unless otherwise authorized by Macrovision Corporation. Reverse engineering or disassembly is prohibited.



Notes on discs (continued)

About this owner's manual

This owner's manual explains the basic instructions of this DVD video player. Some DVD video discs are produced in a manner that allows specific or limited operation during playback. As such, the DVD video player may not respond to all operating commands. This is not a defect in the DVD video player. Refer to instruction notes of discs.

"Ⓢ" may appear on the TV screen during operation. A "Ⓢ" means that the operation is not permitted by the DVD video player or the disc.

Notes on region numbers

The region number of this DVD video player is 1. If region numbers, which stand for their playable area, are printed on your DVD video disc and you do not find  or , disc playback will not be allowed by the player. (In this case, the DVD video player will display a message on-screen.)



Notes On VIDEO CDs

This DVD video player supports VIDEO CDs equipped with the PBC (Version 2.0) function. (PBC is the abbreviation of playback Control.) You can enjoy two playback variations depending on types of discs.

- VIDEO CD not equipped with PBC function (Version 1.1)
Sound and movie can be played on this DVD video player in the same way as an audio CD.
- VIDEO CD equipped with PBC function (Version 2.0)
In addition to operation of a VIDEO CD not equipped with the PBC function, you can enjoy playback of interactive software with search function by using the menu displayed on the TV screen (Menu playback).
Some of the functions described in this owner's manual may not work with some discs.

Playable discs

This DVD video player can play the following discs.

	Disc Mark	Contains	Disc Size	Maximum playback time
DVD video discs		Audio + Video (movingses)	12 cm	Approx. 4 hours (single sided disc)
				Approx. 8 hours (double sided disc)
			8 cm	Approx. 80 minutes (single sided disc)
				Approx. 160 minutes (single sided disc)
Video CDs		Audio + Video (moving pictures)	12 cm	Approx. 74 minutes
			8 cm (CD single)	Approx. 20 minutes
Audio CDs		Audio	12 cm	Approx. 74 minutes
			8 cm (CD single)	Approx. 20 minutes

The following discs are also available.

- DVD-R discs of DVD video format
- CD-R/CD-RW discs of CD-DA format

Some of these discs may be incompatible.

- You cannot play discs other than those listed above.
- You cannot play DVD-RAM discs or non-standardized discs, etc., even if they may be labeled as above.
- This DVD video player uses the NTSC color system, and cannot play DVD video discs recorded in any other color system (PAL, SECAM, etc.).

Because of problems and errors that can occur during the creation of DVD software and/or the manufacture of DVD discs, Toshiba America Consumer Products, L.L.C., Toshiba Hawaii, Inc. and Toshiba of Canada, Ltd. cannot guarantee that this player will play every feature of every DVD bearing the DVD logo. As one of the creators of DVD technology, Toshiba DVD players are manufactured to the highest standards of quality and, as a result, such incompatibilities are very rare. If you happen to experience and difficulty playing a DVD on a Toshiba DVD player, please feel free to call our Contact listed in "LIMITED UNITED STATES WARRANTY DVD PLAYERS" .

Table of Contents

Introduction

●SAFETY PRECAUTIONS.....	2
●IMPORTANT SAFETY INSTRUCTIONS.....	4
●Precautions.....	8
●Notes on Discs.....	9
Notes on region numbers.....	10
●Table of Contents.....	11
●Identifications of controls.....	12
Front panel.....	12
Rear panel.....	13
Remote control.....	14
Loading batteries.....	15
Operating with the remote control.....	15

Connections

●Connecting to a TV.....	18
Connecting to a TV.....	18
Connecting to an audio system and TV equipped with component video inputs.....	19
●Connecting to Optional Equipment.....	20
Connecting to an amplifier equipped with a Dolby Digital decoder.....	21
Connecting to an amplifier equipped with a Dolby Surround Pro Logic.....	21
Connecting to an amplifier equipped with a DTS decoder.....	22
Connecting to an amplifier equipped with a digital audio input.....	22

Basic playback

●Playing a Disc	
Basic playback.....	24
●Variable Speed Playback.....	26
Playing in fast reverse or fast forward directions.....	26
Playing frame by frame.....	26
Playing in slow-motion.....	27
Resume playback from the same location.....	27
●Locating a Desired Section.....	28
Locating a title using the top menu.....	28
Locating a desired section by entering the corresponding number.....	29
Locating a specific chapter or track.....	29

Advanced playback

●Accessing a Specific Location Directly...32	
Entering the time counter of the desired location.....	32
Setting a bookmark.....	32
●Repeating a Specific Segment.....33	
Repeating a specific segment.....	33
●Playing in a Varied Order.....34	
Playing titles, chapters or track in a varied order.....	34
●Playing in a Favorite Order.....35	
Setting titles, chapters or tracks in a favorite order.....	35
●Zooming a picture.....36	
zooming a picture.....	36
●Selecting the Picture Enhancement (E.P.M.).....	37
Selecting the picture enhancement.....	37
●Selecting the Sound Enhancement (E.A.M.).....	38
Selecting the sound enhancement.....	38
●Selecting the Camera Angle.....39	
Changing the camera angle.....	39
●Selecting Subtitles.....40	
Selecting a subtitle language.....	40
●Selecting a Language.....41	
Selecting a playback audio setting.....	41
●On-screen display operation.....43	
On-screen display operation.....	43
●Playing MP3/WMA Files.....46	
Playing MP3/WMA Files.....	46
●Viewing JPEG Files.....48	
Starting a slide show.....	48
Starting from a thumbnail view or a folder list.....	50
Viewing a single image.....	51

Function setup

●Customizing the Function Settings.....56	
Setting procedure.....	56
Setting details.....	58
●Table of Languages.....62	

Others

●Before Calling Service Personnel.....64	
●Specifications.....65	
●LIMITED UNITED STATES WARRANTY DVDPLAYERS.....	66

Identification of Controls

See the page in for details.

Front panel

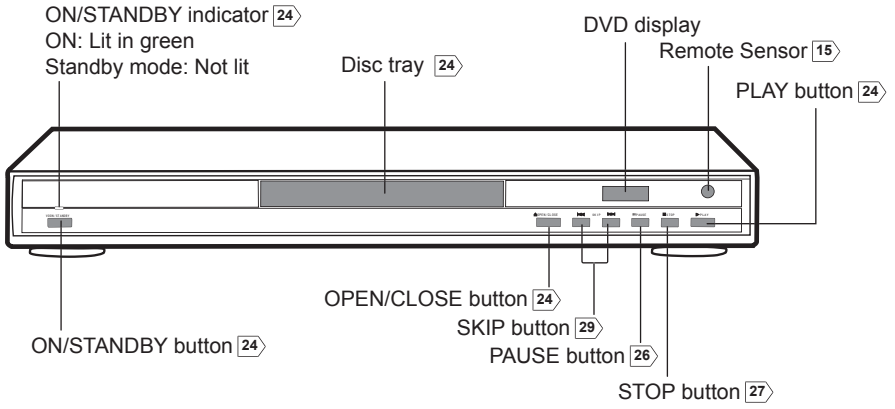

Rear panel

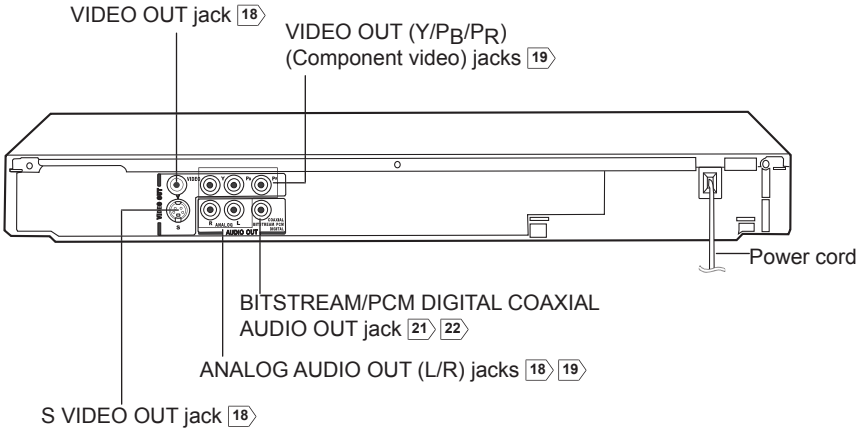

Identification of Controls (continued)

The instructions in this manual describe the functions on the remote control. See the page in for details

Remote control

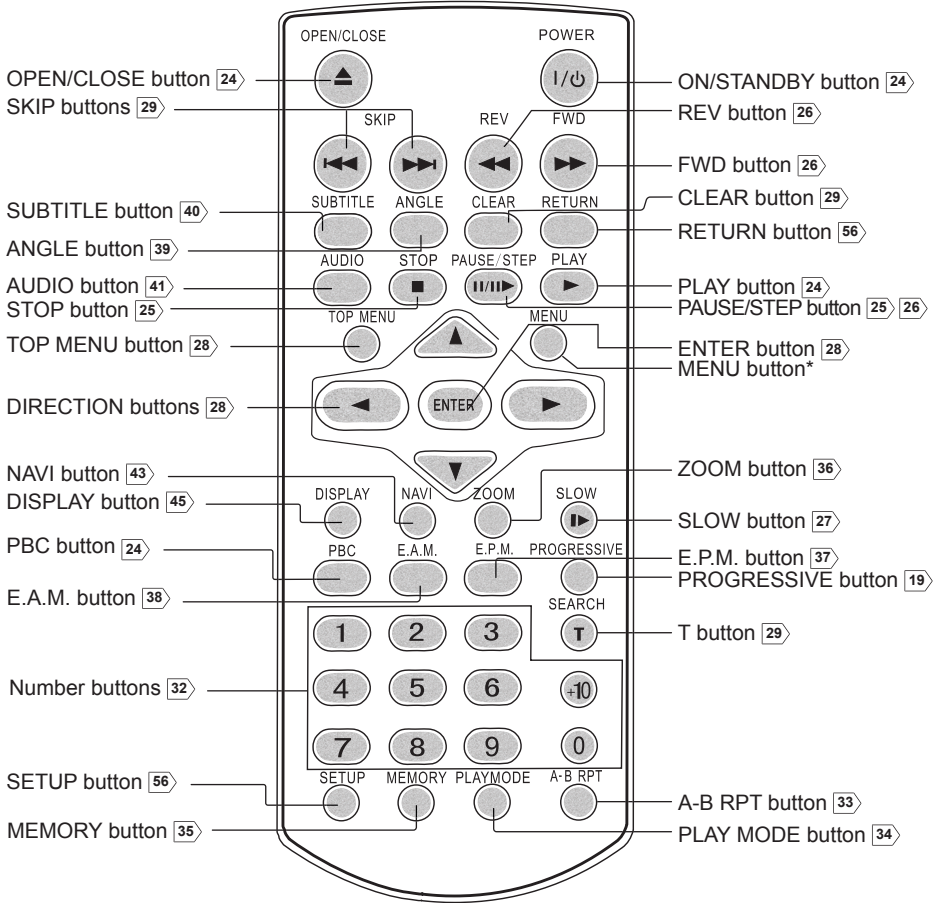

* MENU button
Use the MENU button to display the menu included on many DVD video disc. To operate a menu, follow the instructions in "Locating a title using the top menu." [28]

Loading batteries

1 Open the cover.

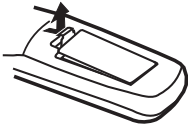

2 Insert batteries (AAA size).

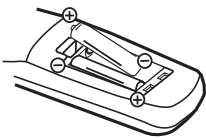

Make sure to match the + and - on the batteries to the marks inside the battery compartment.

3 Close the cover.

Notes on batteries

Improper use of batteries may cause battery leakage and corrosion. To operate the remote control correctly, follow the instructions below.

- Do not insert batteries into the remote control in the wrong direction.
- Do not charge, heat, open, or short-circuit the batteries.
Do not throw batteries into a fire.
- Do not leave dead or exhausted batteries in the remote control
- Do not use different types of batteries together, or mix old and new batteries.
- If you do not use the remote control for a long period of time, remove the batteries to avoid possible damage from battery corrosion.
- If the remote control does not function correctly or if the operating range becomes reduced, replaced all batteries with new ones.
- If battery leakage occurs, wipe the battery liquid from the battery compartment, then insert new batteries.

Operating with the remote control

Point the remote control at the remote sensor and press the buttons.

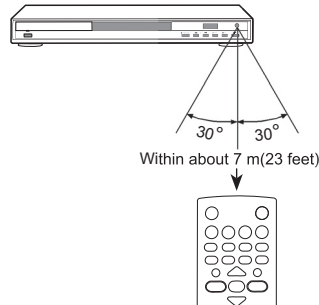

Distance: Maximum of 7 m (23 feet) from the front of the remote sensor.

Angle: Approximately 30° from each direction of the front of the remote sensor.

- * Do not expose the remote sensor of the DVD video player to a strong light source such as direct sunlight or other illumination. If you do so, you may not be able to operate the DVD video player via the remote control.

Notes on the remote control

- Direct the remote control at the remote sensor of the DVD video player.
- Do not drop or give the remote control a shock.
- Do not leave the remote control near an extremely hot or humid place.
- Do not spill water or put anything wet on the remote control.
- Do not disassemble the remote control.

Connections

Read this chapter first to make all necessary preparations.

- **Connecting to a TV**
- **Connecting to an audio system and TV equipped with component video inputs**
- **Connecting to an amplifier equipped with a Dolby Digital decoder**
- **Connecting to an amplifier equipped with Dolby Surround Pro Logic**
- **Connecting to an amplifier equipped with a DTS decoder**
- **Connecting to an amplifier equipped with a digital audio input**

Connecting to a TV

Connect the DVD video player to your TV.

For details of output sound, see [42](#).

Connecting to a TV

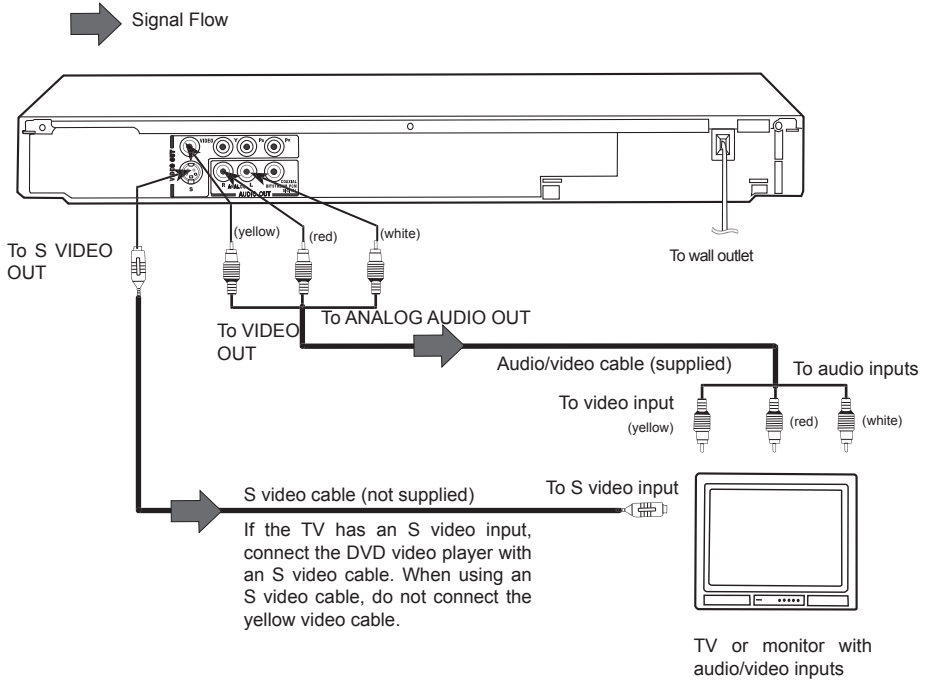

- Making the following setting.

On-screen display	Select:	Page
"Digital Output"	"Bitstream" or "PCM"	56 60
"Video Output"	CVBS	59

Notes

- Refer to the owner's manual of the connected TV as well.
- When you connect the DVD video player to your TV, be sure to turn off the power and unplug both units from the wall outlet before making any connections.
- If your TV has one audio input, connect the left and right audio outputs of the DVD video player to a Y cable adapter (not supplied) and then connect to your TV
- connect the DVD player directly to your TV. If you connect the DVD video player to a VCR, TV/VCR combination or video selector, playback picture may be distorted as DVD video discs are copy protected.
- Analog audio out will not have sound DTS playback.

Interlaced outputs/inputs (ColorStream®)

Some TVs or monitors are equipped with component video inputs. Connecting to these inputs allows you to enjoy higher quality picture playback.

Actual labels for component video inputs may vary depending on the TV manufacturer. (ex. Y, R-Y, B-Y or Y, C_B, C_R)

In some TVs or monitors, the color levels of the playback picture may be reduced slightly or the tint may change. In such a case, adjust the TV or monitor for optimum performance.

Progressive outputs/inputs (ColorStream®Pro)

Some TVs or monitors are equipped with component video inputs that are capable of reproducing a progressively scanned video signal. Connecting to these inputs allow you to view the highest quality picture with less flicker.

Consumers should note that not all high definition television sets are fully compatible with this product and may cause artifacts to be displayed in the picture. In case of 480 progressive scan picture problems, it is recommended that the user switch the connection to the "standard definition" output. If there are questions regarding our TV set compatibility with this model 480p DVD player, please contact our Customer Service Center.

Connecting to an audio system and TV equipped with component video inputs

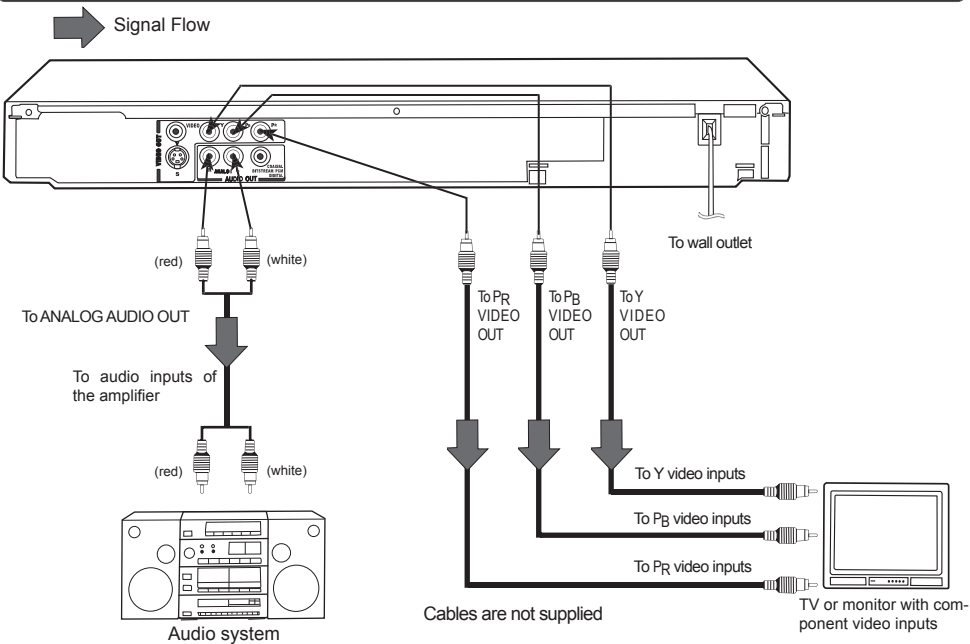

■ Before switching interlace video output to progressive scan, be sure to set "Video Output" to "Y PbPr"

You can temporarily switch the output signal for better picture quality.

Press **PROGRESSIVE** on the remote control during stop.

- Making the following setting.

On-screen display	Select:	Page
"Digital Output"	"Bitstream" or "PCM"	56 60
"Video Output"	Y Pb Pr	59

Notes

- Refer to the owner's manual of the connected equipment as well.
- When you connect the DVD video player to other equipment, be sure to turn off the power and unplug all of the equipment from the wall outlet before making any connections.
- If you place the DVD player near a tuner or radio, the radio broadcast sound might be distorted. In this case, place the DVD video player away from the tuner and radio.
- The output sound of the DVD video player has a wide dynamic range. Be sure to adjust the receiver's volume to a moderate listening level. Otherwise, high volume sound may damage your hearing as well as the speakers.
- Turn off the amplifier before you connect or disconnect the DVD video player's power cord, if you leave the amplifier power on, the speakers may be damaged.
- Analog audio out will not have sound DTS playback.

Connecting to Optional Equipment

You can enjoy high quality dynamic sounds by connecting the DVD video player to optional audio equipment.

- For connection to your TV, see "Connecting to a TV".
18 19
- For details of output sound, see 42.
- This section uses the following reference marks..

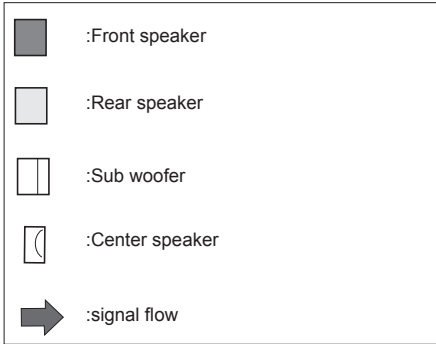

Notice

- When you are connecting (via the BITSTREAM/PCM AUDIO OUT jack) an AV decoder that does not have Dolby Digital, Digital Theater Systems (DTS) decoding function, be sure to set "Digital Output" to "PCM" from the on-screen displays. Otherwise, high volume sound may damage your hearing as well as the speakers.
- When playing DTS-encoded discs (audio CDs), excessive noise may be output from the analog audio output jacks. To avoid possible damage to the audio system, you should take proper precautions when the analog audio output jacks of the DVD video player are connected to an amplification system. To enjoy DTS Digital Surround™ playback, an external 5.1 channel DTS Digital Surround™ decode system must be connected to the BITSTREAM/PCM AUDIO OUT jack of the DVD video player.

Notes:

- DO NOT connect the BITSTREAM/PCM AUDIO OUT jack of the DVD video player to the AC-3 RF input of a Dolby Digital Receiver. This input on your A/V receiver is reserved for Laser disc use only and is incompatible with the BITSTREAM/PCM AUDIO OUT jack of the DVD video player.
- Connect the BITSTREAM/PCM AUDIO OUT jack of the DVD video player to the "DIGITAL (COAXIAL)" input of a Receiver or Processor.
- Refer to the owner's manual of the connected equipment as well.
- When you connect the DVD video player to other equipment, be sure to turn off the power and unplug all of the equipment from the wall outlet before making any connections.
- The output sound of the DVD video player has a wide dynamic range. Be sure to adjust the receiver's volume to a moderate listening level. Otherwise, the speakers and your hearing may be damaged by a sudden high volume sound.
- Turn off the amplifier before you connect or disconnect the DVD video player's power cord. If you leave the amplifier power on, the speakers may be damaged.

Connecting to an amplifier equipped with a Dolby Digital decoder

Dolby Digital

Dolby Digital is the surround sound technology used in theaters showing the latest movies, and is now available to reproduce this realistic effect the home. You can enjoy motion picture and live concert DVD video discs with this dynamic realistic sound by connecting the DVD video player to a 6 channel amplifier equipped with a Dolby Digital decoder or Dolby Digital processor. If you have a Dolby Surround Pro Logic decoder, you will obtain the full benefit of Pro Logic from the same DVD movies that provide full 5.1-channel Dolby Digital soundtracks, as well as from titles with the Dolby Surround mark.

Manufactured under license from Dolby Laboratories. "Dolby", "Pro Logic" and the double-D symbol are trademarks of Dolby Laboratories. Confidential unpublished works. Copyright 1992-1997 Dolby Laboratories. All rights Reserved.

- Use DVD video discs encoded via the Dolby Digital recording system.
- Make the following setting.

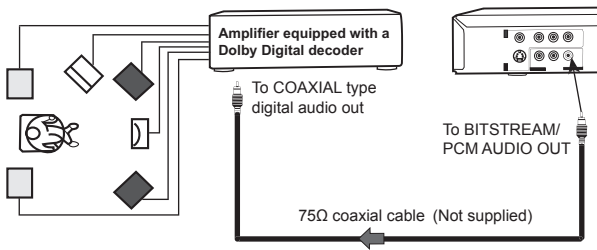

On-screen display	Select:	Page
"Digital Output"	"Bitstream"	56
		60
Recording system	D	42

Connecting to an amplifier equipped with Dolby Surround Pro Logic

Dolby Surround Pro Logic

You can enjoy the dynamic realistic sound of Dolby Surround Pro Logic by connecting an amplifier and speaker system(right and left front speakers, a center speaker, and one or two rear speakers).

- With an amplifier equipped with Dolby Digital connect the equipment the same way as described in "Connecting to an amplifier equipped with a Dolby Digital decoder." Refer to that amplifier's owner's manual and set the amplifier so you can enjoy Dolby Surround Pro Logic sound.
- With an amplifier not equipped with Dolby Digital connect the equipment as follows.

- Make the following setting.

On-screen display	Select:	Page
"Digital Output"	"Bitstream" or "PCM"	56
		60

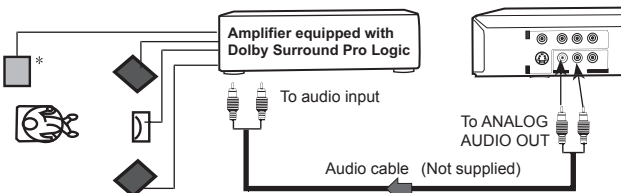

* Connect one or two rear speakers. The output sound from the rear speakers will be monaural even if you connect two rear speakers.

Connecting to Optional Equipment

Connecting to an amplifier equipped with a DTS decoder

Digital Theater System(DTS)

DTS is a high quality surround technology used in theaters and now available for home use, on DVD video discs or audio CDs. If you have a DTS decoder or processor, you can obtain the full benefit of 5.1 channel DTS encoded sound tracks on DVD video discs or audio CDs.

"DTS" and "DTS Digital Out" are trademarks of Digital Theater Systems, Inc

- Use DVD video discs or audio CDs encoded via the DTS recording system.
- Make the following setting.

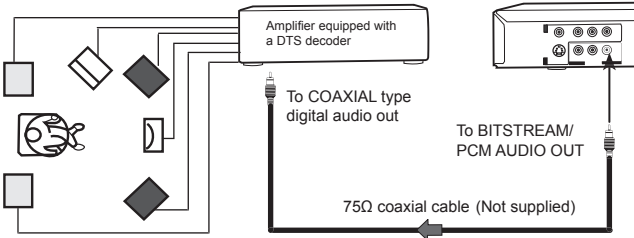

On-screen display	Select:	Page
"Digital Output"	"Bitstream" or "PCM"	56 60
Recording system	DTS	42

Connecting to an amplifier equipped with a digital audio Input

2 channel digital stereo

You can enjoy the dynamic sound of 2 channel Digital stereo by connecting an amplifier equipped with a digital audio input and speaker system (right and left front speakers).

- Make the following setting.

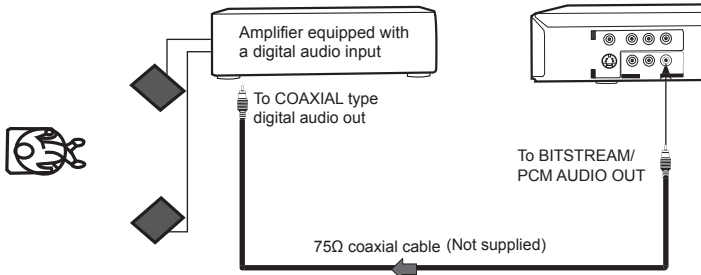

On-screen display	Select:	Page
"Digital Output"	"PCM"	56 60



Basic playback

Begin your operation.

- **Playing a Disc**
- **Variable Speed Playback**
- **Locating a Desired Section**

Playing a Disc

This section shows you the basics on how to play a disc.

CAUTION

Keep your fingers well clear of the disc tray as it is closing. Neglecting to do so may cause serious personal injury.

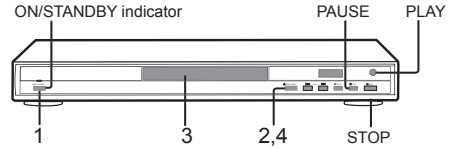

Basic Playback

Preparations

- When you want to view a disc, turn on the TV and select the video input connected to the DVD video player.
- When you want to enjoy the sound of discs from the audio system, turn on the audio system and select the input connected to the DVD video player.

1 Press the ON/STANDBY button.

POWER The DVD video player turns on. The ON/STANDBY indicator on the player illuminates.



When the DVD video player is turned on for the first time, make the proper settings before proceeding to step 2.

2 Press OPEN/CLOSE.

The disc tray opens.



3 Place the disc on the disc tray.

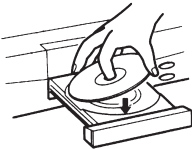

- There are two different disc sizes. Place the disc in the correct guide on the disc tray. If the disc is out of the guide, it may damage the disc and cause the DVD video player to malfunction.
- Do not place a disc which is unplayable in this DVD video player.

4 Press OPEN/CLOSE to close the disc tray. Playback starts

OPEN/CLOSE



If you insert a DVD video disc that contains a top menu, a menu may appear. Use the Direction buttons to select the title you want to view, then press ENTER to start playback. See "Locating a title using the top menu".

- You may need to press the TOP MENU or MENU button to display disc menu. (depending on the actual DVD video disc.)

Note

For resuming playback, see [27].

To start playback in stop mode

Press **PLAY**.



Note

Video CD with PBC

- If you set Video CD with PBC in the player, the MENU screen is appeared and you can choose a scene from MENU screen.
- You can select PBC On or Off to press PBC button on the remote control.
- If you press RETURN button on the remote control while PBC is ongoing, the screen will become previous one.

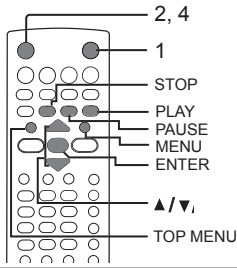

■ **To obtain a higher quality picture**

Occasionally, some picture noise not usually visible during a normal broadcast may appear on the TV screen while playing a DVD video disc because the high resolution pictures on these discs include a lot of information. While the amount of noise depends on the TV you use with this DVD video player, you should generally reduce the sharpness adjustment on your TV when viewing DVD video discs.

■ **About DVD VCD CD**

The DVD VCD CD icons on the heading bar show the playable discs for the function described under that heading.

DVD : You can use this function with DVD video discs.

VCD : You can use this function with VIDEO CDs.

CD : You can use this function with audio CDs.

■ **To pause playback (still mode)**

Press PAUSE/STEP during playback.

PAUSE/STEP To resume normal playback, press the PLAY button.



- The sound is muted during still mode.

■ **To stop playback**

Press STOP.



■ **To remove the disc**

Press OPEN/CLOSE.

OPEN/CLOSE Remove the disc after the disc tray opens completely.

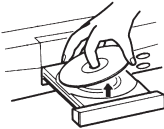

Be sure to press the OPEN/CLOSE button to close the disc tray after you remove the disc.

■ **To turn the power off (To enter the standby mode).**

Press ON/STANDBY and the ON/STANDBY indicator turns off.

Note

Be aware that this equipment is still powered even after the ON/STANDBY indicator turns off (standby mode) by pressing the ON/STANDBY button. To disconnect this equipment completely from the main power, pull out the power plug from the wall outlet.

■ **About the screen saver**

If you leave the DVD video player unattended for a long while, the screen saver of the DVD video player automatically appears. To turn off the screen saver, press the PLAY button.

■ **Automatic Power Off function**

If the DVD video player is stopped or the screen saver is engaged for approximately 20 minutes, the DVD video player automatically turns itself off.

Notes

- Do not move the DVD video player during playback. Doing so may damage the disc.
- Use the OPEN/CLOSE button to open and close the disc tray. Do not push the disc tray while it is moving. Doing so may cause the DVD video player to malfunction.
- Do not push up on the disc tray or put any objects other than discs on the disc tray. Doing so may cause the DVD video player to malfunction.
- In many instances, a menu screen will appear after playback of a movie is completed. Prolonged display of an on-screen menu may damage your television set, permanently etching that image onto its screen. To avoid this, be sure to press the STOP button on your remote control once the movie is completed.

Variable Speed Playback

You can play discs at various speeds. Also you can resume playback from the location where you stopped playback.

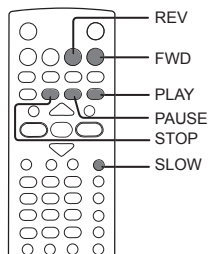

Playing in fast reverse or fast forward directions

Press REV or FWD during playback.

REV FWD



REV: Fast reverse playback
FWD: Fast forward playback

Each time you press the REV or FWD button, the playback speed changes.

■ To resume normal playback

Press PLAY.

PLAY



Notes

- The DVD video player mutes sound and subtitles during reverse and forward scan of DVD video discs. And it also mutes sound during fast forward or fast reverse play of audio CDs.
- The playback speed may differ depending on the disc.

Playing frame by frame

Press PAUSE/STEP during still playback.

PAUSE/STEP



Each time you press the PAUSE/STEP button, the picture advances one frame.

■ To resume normal playback

Press PLAY.

PLAY



Note

The sound is muted during frame by frame playback.



Playing in slow-motion

Press SLOW during playback.

SLOW



Each time you press the SLOW button, the slow-motion speed changes.

■ To resume normal playback

Press PLAY.

PLAY



Note

The sound is muted during slow-motion playback.



Resume playback from the same location

1 Press STOP once at the location where you want to interrupt playback.

STOP



The DVD video player memorizes the location where playback is stopped.

2 Press PLAY.

PLAY



The DVD video player resumes playback from the location where you stopped playback.

■ To start playback from the beginning regardless of the location where you stopped playback.

1. Press STOP twice.

STOP





The DVD video player deletes the memory of the location.

2. Press PLAY.

PLAY



 Playback starts from the beginning of the current chapter.

 Playback starts from the beginning of the disc.

Notes

- Resuming cannot function when:
 - you change the parental lock setting or select a disc menu language.
 - you play a PBC-featured VIDEO CD while "PBC" is set to "On".
 - you open the disc tray.
- There may be a difference in the location where playback resumes depending on the disc.
- The DVD player retains settings by the on-screen display. This memory may need to be cleared for resume playback.

Locating a Desired Section

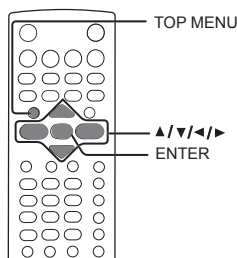

Normally, DVD video discs are divided into titles, and the titles are sub-divided into chapters. VIDEO CDs and audio CDs are divided into tracks. You can quickly locate any specific title, chapter, or track.

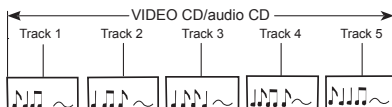
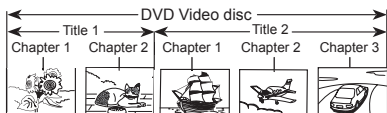

DVD Locating a title using the top menu

1 Press TOP MENU.

TOP MENU



The top menu appears on the TV screen.

e.g.

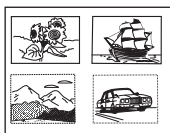

2 Press ▲/▼/◀/▶ to select the title you want.

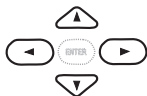

If the titles in the top menu are assigned a number, you can directly locate a specific title by pressing its designated number with the number buttons.

3 Press ENTER.



Playback starts from chapter 1 of the selected title.

Notes

- The instructions above describe basic procedures which may vary depending on the contents of the DVD video disc. If different instructions appear on the TV screen, follow those instructions.
- If you display the top menu during playback and press the TOP MENU button again without selecting any title, the DVD video player may resume playback from the point where you first pressed the TOP MENU button (depending on the actual DVD video disc.)
- This method of locating a title is available only on a disc that contains a top menu.
- Instruction notes of discs may refer to the button that displays the top menu as TITLE button.

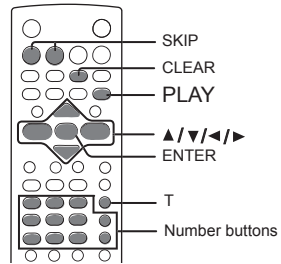

DVD VCD CD Locating a desired section by entering the corresponding number

1 Press T.

If you are using a VIDEO CD/audio CD, skip step 2. Then at step 3, enter the number for the track you want using the number buttons.

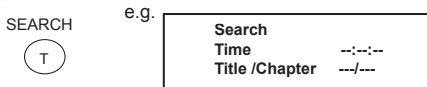

2 Press ▲/▼ to select a section (Time or Title/Chapter) you want to locate.

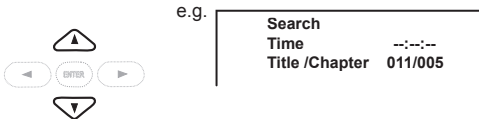

Make sure that the spaces next to the Time or Title/Chapter are highlighted.

3 Press the number buttons to enter a number of the section.

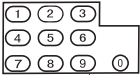

4 Repeat steps 2 and 3 if necessary.

5 Press ENTER.

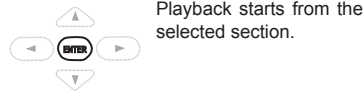

Notes

- Pressing the CLEAR button resets the numbers. To clear the display, press the T button repeatedly until the menu disappears.
- This method of locating a title is available only on a disc that contains title numbers.

DVD VCD CD Locating a specific chapter or track

Press SKIP ◀◀ or ▶▶ repeatedly to access the chapter or track number you want.

Playback starts from the selected chapter or track.



To locate succeeding chapter or tracks.



Playback starts from the beginning of the current chapter or track. when you press twice, playback starts from the beginning of the preceding chapter or track.

Notes

- Some titles may not display chapter numbers.
- If you press the SKIP ◀◀ or ▶▶ button on the front panel during playback, the DVD video player performs fast reverse or fast forward playback. You can vary the speed by pressing the button repeatedly.

Advanced playback

Customizing the performance of your DVD video player.

- Accessing a Specific Location Directly
- Repeating a Specific Segment
- Playing in a Varied Order
- Playing in a Favorite Order
- Zooming a Picture
 - Selecting the Picture Enhancement (E.P.M.)
- Selecting the Sound Enhancement (E.A.M.)
- Selecting the the Camera Angle
- Selecting Subtitles
- Selecting a Language
- On-screen Display Operation
- Playing MP3/WMA Files
- Viewing JPEG Files

Accessing a Specific Location Directly

You can access specific location by entering its corresponding time (hours, minutes, seconds)

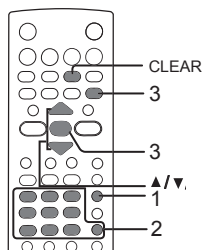

Entering the time counter of the desired location

1 Press T once.

SEARCH Press the button, the time counter is highlighted.



e.g.

Search	---
Time	---:--
Title /Chapter	---/---

2 Press the number buttons to enter the time.

e.g.



Search	
Time	01:25:30
Title /Chapter	---/---

3 Press ENTER.



Playback starts from the specified location.

Notes

- Some discs may not respond to this process.
- Some scenes may not be located precisely as you specified.
- This method for accessing specific locations is available only within the range of the total time of the DVD video disc or VIDEO CD/audio CD.

Setting a bookmark

1 Press T twice during playback.

SEARCH



The following menu appears.

Bookmark	---
Bookmark	---
Bookmark	---

2 Press the ENTER button at the point you want to locate.

The point is registered as a bookmark.

3 Press the ▲/▼, buttons to highlight the next two spaces to set the bookmarks as you preferred.



■ To clear the bookmark
Press CLEAR.

■ To quit the feature
Press T again.

■ To jump to the bookmarks.
Press T twice to display the bookmark menu. Highlight the items by pressing the ▲/▼, buttons and select a bookmark, press ENTER.
Playback starts from the the point that is registered.

Notes

- You can save three bookmarks.
- There may be a difference between a marked point and the location you actually jump to.
- Some points may not be marked.
- A bookmark will be erased when:
 - you turn off the power of the DVD video player.
 - you open the disc tray
- A bookmark may not be set on an MP3/WMA/JPEG file.

Repeating a specific segment

You can specify a desired segment and repeat it.

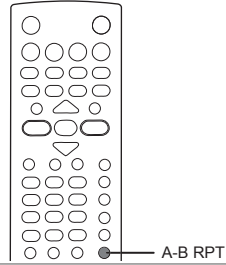

DVD
VCD
CD

Repeat a specific segment

- 1 Press **A-B RPT** at the beginning of the segment (point **A**) you want to play repeatedly.

A-B RPT



Rep A-

- 2 Press **A-B RPT** again at the end of the segment (point **B**).

The DVD video player automatically returns to point A and starts repeat playback of the selected segment. (A-B)

A-B RPT



Rep A-B

■ To resume normal playback

Press **A-B RPT** until "**Rep Off**" appears on the TV screen.

A-B RPT



Rep Off

Notes

- Some discs may not permit A-B repeat operation.
- You can specify a segment only within the current title or track (VIDEO CD/Audio CD).
- There may be a slight difference between point A and the location where playback actually resumes depending on the disc.

Playing in a Varied Order

You can play titles, chapters within a title, or track in a varied order.

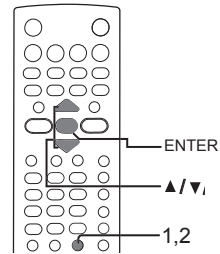

DVD VCD CD **Playing titles, chapters or tracks in a varied order**

1 Press PLAY MODE during playback, the screen displays as follows.

PLAY MODE



Highlight the items you want to select by pressing ▲/▼, then press ENTER repeatedly.

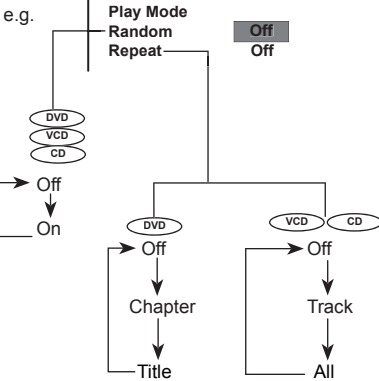

Chapter/Title/Track Repeat:

Repeats the current chapter/title/track.

All Repeat:

Repeats the entire disc.

Chapter Random:

Plays the chapters within the current title in random order.

Title/Track Random:

Plays the title/track in random order.

Random Off/ Repeat Off:

Resumes normal playback.

If you press the PLAY MODE button during playback, the DVD video player automatically enters the selected playback mode after finishing the current title, chapter, or track.

2 Press PLAY MODE.

The DVD video player automatically enters selected playback mode.

■ **To resume normal playback**

While the display appears on the screen, press the ENTER button repeatedly in both items, until the playback mode changes to "Off".



Notes

- Some discs may not permit these operations.
- You cannot set Playback Mode during stop.

Playing in a Favorite Order

You can combine your favorite titles, chapters or tracks and play them in the order you determine. You can program up to 12 selections into the memory. (Memory playback)

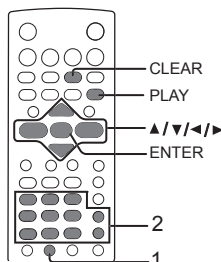

Setting titles, chapters or tracks in a favorite order

1 Insert a disc and press MEMORY.

The following display appears.

MEMORY
○

e.g. (DVD)

Memory Input	Title/Chapter
1 ---	4 --- 7 --- 10 ---
2 ---	5 --- 8 --- 11 ---
3 ---	6 --- 9 --- 12 ---

Play Memory Clear All

Chapter number
Title number
e.g. (VIDEO CD/Audio CD)

Memory Input	Track
1 ---	4 --- 7 --- 10 ---
2 ---	5 --- 8 --- 11 ---
3 ---	6 --- 9 --- 12 ---

Play Memory Clear All

Track number

2 Select the items in order you want by pressing the number buttons.

Each time you press the $\blacktriangle/\nabla/\blacktriangleleft/\blacktriangleright$ button, the space is highlighted in turn. Highlight where you want to enter, then press the corresponding number buttons.

To select tracks from a VIDEO CD/audio CD in order, press the number buttons for the track.

3 Highlight "Play Memory" while the display appears on the TV screen, then press the ENTER button.

ENTER
ENTER

The DVD video player starts memory playback.

■ To change the programmed selections

- 1 While the display appears on the TV screen, press $\blacktriangle/\nabla/\blacktriangleleft/\blacktriangleright$ to move the highlighted bar to the item you want to change.
- 2 Change the selection following the instructions in step 2.

■ To cancel the programmed selections

- 1 while the display appears on the TV screen, press $\blacktriangle/\nabla/\blacktriangleleft/\blacktriangleright$ to move the highlighted bar to the item you want to cancel.
- 2 Press CLEAR.

■ To resume normal playback from memory playback

Press MEMORY button.

Press $\blacktriangle/\nabla/\blacktriangleleft/\blacktriangleright$ to move the highlighted bar to "Clear All", then press the ENTER. All the input programmes will be cleared.



Press PLAY button to resume normal playback.

Normal playback will start from first location.

■ To program during playback.

If you press the MEMORY button during playback, a programming display appears. Follow steps 2 and 3.

Notes

- Some discs may not permit memory playback operation.
- When you input only title number, the playback starts from the first chapter of the selected title.
- If you press the PLAY MODE button during memory playback, the DVD video player repeats the current memory playback.
- If you press the MEMORY or PLAY button while the display appears on the TV screen, the display disappears.
- The programmed selections will be cleared when you turn off the DVD video player.

Zooming a Picture

You can magnify areas within a picture.

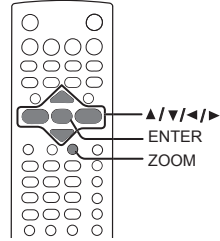
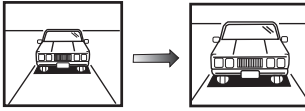

DVD
VCD

Zooming a Picture

Press **ZOOM** button during normal, slow or still playback.



The DVD video player enters the zoom playback mode and displays the icon.

e.g.

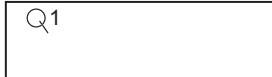

As you repeatedly press the ZOOM button, the magnification level changes.

e.g. Q1 → Q2 → Q3 → QOff

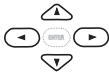

If you press the **▲/▼/◀/▶** buttons, the zoom point shifts.

■ To resume normal playback

Press the ZOOM button repeatedly until the icon "QOff" appears on the TV screen.



Notes

- Some discs may not respond to zoom feature.
- During some scenes, the buttons may not work as described.
- Zooming does not work on subtitles or menus included on DVD video discs.
- The magnification level varies depending on the setting of TV shape you select. 59

Selecting the Picture Enhancement (E.P.M. *)

You can easily select a preferred picture enhancement.

* E.P.M.: Enhanced Picture Mode

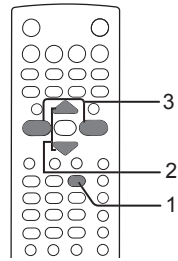



Selecting the picture enhancement

1 Press E.P.M.

The picture enhancement menu appears.



Video Enhance
Brightness  08
Sharpness  08

■ To exit the picture enhancement selection
Press E.P.M. again.

E.P.M.



Note

Actual effect to picture may vary depending on the TV. Make a selection according to your preference.

2 Select the item by pressing ▲/▼.

3 Press the ◀/▶ buttons.

Each time you press the button, the picture enhancement changes.

Brightness:
Brightness levels raised for enhanced picture clarity.

Sharpness:
For sharpness reproduction.

Selecting the Sound Enhancement (E.A.M.*)

You can easily select a preferred audio enhancement.

* E.A.M.: Enhanced Audio Mode

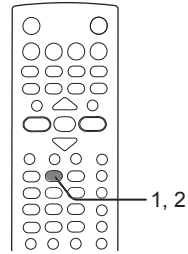

DVD VCD Selecting the sound enhancement

1 Press E.A.M.

The sound enhancement icon appears.

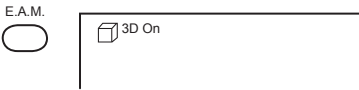

2 Select the sound enhancement by pressing the E.A.M. button repeatedly.

Each time you press the button, the sound enhancement changes.



3D:
To obtain expansive virtual surround sound effects from just two speakers.

- To use this enhancement of sounds output from the BITSTREAM/PCM jack, be sure to set "Digital Output" to "PCM". See [60](#).

■ To exit the audio enhancement selection

Leave the DVD video player unattended for about 5 seconds after having made a selection.

Notes

- Actual effects to sounds may vary depending on the speaker system. Make a selection according to your preference.
- Actual effects to sounds may vary depending on the disc.
- When the DVD video player is connected to an amplifier equipped with Dolby Pro Logic, select "3D Off". Otherwise, Dolby Pro Logic may function differently than usual.

Selecting the Camera Angle

If the scene was recorded from multiple angles, you can easily change the camera angle of the scene you are watching.

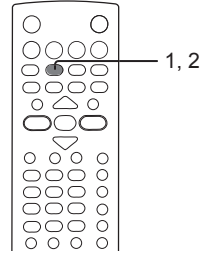
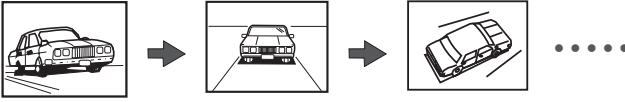

DVD

Changing the camera angle

1 Press ANGLE while playing a scene recorded with multiple angles.

ANGLE
 While playing a scene recorded with multiple angles, angle icon will be displayed for about 3 seconds, press the ANGLE button.

e.g. 

2 Press ANGLE while the angle icon is displayed on the TV screen.

ANGLE
 Each time you press the ANGLE button, the camera angle changes.



Notes

- You cannot change the camera angle during still playback.
- If you pause a picture immediately after changing a camera angle, the resumed playback picture may not display the new camera angle.

Selecting Subtitles

You can display subtitles on the TV screen and select a subtitle language from those included on the DVD video disc.

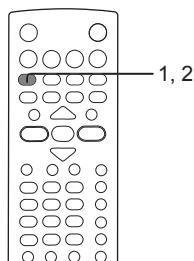

DVD Selecting a subtitle language

1 Press SUBTITLE during playback.

SUBTITLE The current subtitle setting is displayed.



e.g.

1/3 ENG

The abbreviation of the language appears instead of the language name.

2 Press SUBTITLE while the subtitle setting is displayed on the TV screen.



Each time you press the SUBTITLE button, the subtitle languages included on the DVD video disc change.

1/3 ENG → 2/3 FRE →

3/3 SPA → Off

■ To turn subtitles off

Press the SUBTITLE button repeatedly until Off appears on the screen.

SUBTITLE



Notes

- Some DVD video discs are set to display subtitles automatically, and you cannot turn them off even if you set the subtitle function to off.
- During some scenes, the subtitles may not appear immediately after you press the SUBTITLE button.
- Some DVD video discs will allow you to make subtitle selections and turn subtitles on or off only via the disc menu.

Notes

- When you turn on the DVD video player or replace a disc, the player returns to the initial default setting.
- When you select a subtitle language which is not included on the disc, the DVD video player plays a prior language programmed on the disc.
- During some scenes, the subtitles may not appear immediately after you change the subtitle language.

Selecting a Language

You can select a preferred language and sound recording system from those included on the DVD video disc.

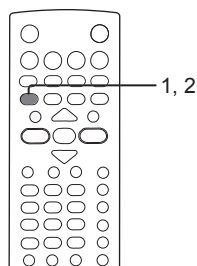
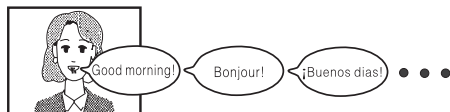

DVD Selecting a playback audio setting

1 Press AUDIO during playback.



The current audio setting is displayed.

e.g.

1/2 DVD 2 ch ENG

The abbreviation of the language appears instead of the language name.

2 Press AUDIO, the audio setting is displayed on the TV screen.



Each time you press the AUDIO button, the audio settings included on the DVD video disc change.

e.g.

1/2 DVD 2 ch ENG
2/2 DVD 5.1 ch ENG

■ Selecting sound channels of VIDEO CDs

You can switch left and right channels by pressing the AUDIO button repeatedly during playback.





Notes

- When you turn on the DVD video player or replace a disc, the player returns to the initial default setting. If you select a sound track which is not included on the disc, the DVD video plays a prior sound track programmed on the disc.
- Some discs allow you to change audio selections only via the disc menu. If this is the case, press the MENU button and choose the appropriate language from the selections on the disc menu.

 **Selecting a playback audio setting**

■ Output sound conversion table

Input \ Output		BITSTREAM/PCM jack		ANALOG AUDIO jacks
		"Digital Output" 		
		"Bitstream"	"PCM"	
DVD video disc	Dolby Digital	Bitstream	PCM	YES
	Linear PCM	PCM	PCM	YES
	DTS	Bitstream	Bitstream	--
	MPEG1, MPEG2	PCM	PCM	YES
VIDEO CD	MPEG1	PCM	PCM	YES
Audio CD	Linear PCM 44.1 kHz/16 bit	PCM	PCM	YES
	DTS	Bitstream	Bitstream	Noise
MP3/WMA		PCM	PCM	YES

 : 3D sound enhancement can function.

- Signals of 96kHz from the BITSTREAM/PCM jack are depressed to 48 kHz by down sampling process when:
 - "3D On" is selected. 
 - a copyright protected disc is played.
- Quantization bit of signals of 20 bit or higher which is output from the BITSTREAM/PCM jack is 16 bit if they are in a copyright protected disc.

On-screen Display Operation

When you turn on the on-screen display, you can view information on operational status and access features and settings.

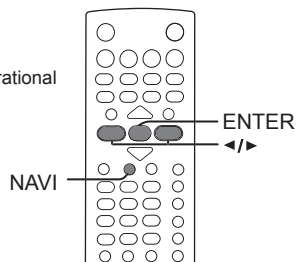

DVD VCD CD On-screen display operation

Press NAVI



The following display appears.

Each time you press the NAVI button, the on-screen display changes as follows.

See the pages in [44](#) for details on the features.

e.g. When playing a DVD video disc

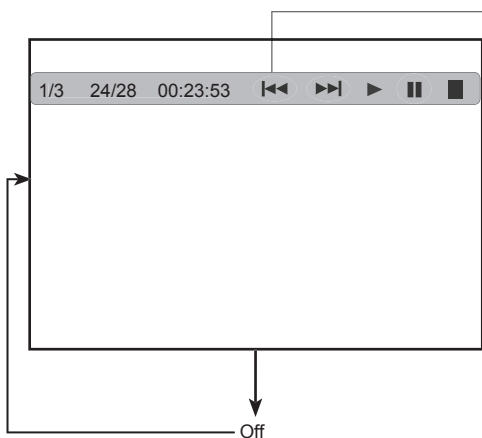

On-screen Display Operation (Continued)

On-screen display operation

■ Features

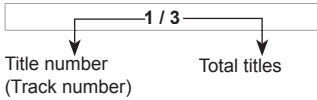

Title number (Track number)
To display the current title or track number.

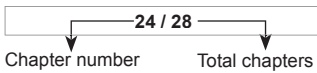

Chapter number
To display the current chapter number.

- : To stop playback.
- ⏮ : Playback starts from the beginning of the current chapter.
- ▶ : To start playback.
- ⏭ : To locate succeeding chapters or tracks.
- ⏸ : To pause playback.

00:23:53

Displays elapse time of the current title or track.

(Continued)

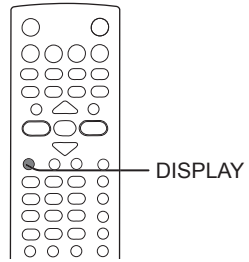

■ Viewing the operational status

- 1 Press DISPLAY once.
The following display appears.

Time counter

Elapsed time/remaining time of the current title

Elapsed time/remaining time of the current track

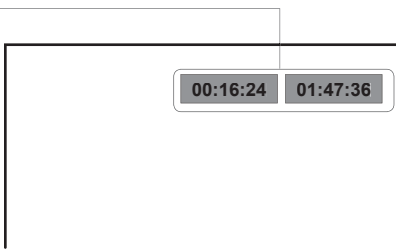

- 2 Press DISPLAY twice.
The following display appears.

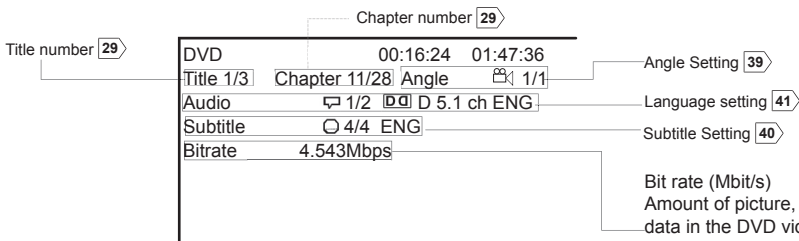

- 3 To turn off the display, press DISPLAY again.

Note

- Some discs may not display the time counter.

Bit rate (Mbit/s)
Amount of picture, sound and subtitle data in the DVD video disc transferred per second.
The larger the value is, the more data processed, but this does not necessarily insure better picture quality.

Playing MP3/WMA Files

You can play MP3/WMA files that have been recorded on a CD-R or CD-ROM on the DVD video player.

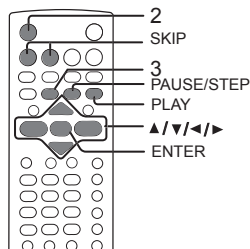

Playing MP3/WMA files

■ Preparations

- Make sure that a disc you want to play is compatible with this DVD video player.

1 Place a CD that contains MP3/WMA files on the disc tray.

2 Press OPEN/CLOSE to load the disc.

OPEN/CLOSE Playback starts.



3 To stop playback, press STOP.



■ Selecting a track (file) in the disc

- 1 Press ◀/▶ to select the column of MP3/WMA file. Press ▲/▼, to select the MP3/WMA file on a list of column.
- 2 Press ENTER or PLAY to play the MP3/WMA file. Press ◀◀ or ▶▶ during playback to skip the tracks.
- 3 Press number buttons 1-10 to select the track which you want, the DVD video player will play the selected track. If the track number is bigger than 10, press 10 first, then next number.

Notes

- You can select a track by designating a track number.
- Press the T button, and input the number you want to play, press ENTER.
- Letters of a file/folder name overflowing the given space will not be displayed.
- You cannot play in Fast reverse or Fast forward during MP3/WMA playback.

■ To pause playback

Press PAUSE/STEP during playback.

PAUSE/STEP



To resume normal playback, press the PLAY button.

Notes

- Some discs may not permit this operations
- WMA tracks copy-protected cannot be played.
- The BITSTREAM/PCM jack outputs MP3/WMA sounds in the linear PCM format regardless of the current "Digital Output" selection. [42]
- If you stop playback by pressing STOP button, and then press the PLAY button, playback will start from the beginning of the track.
- The SKIP and PLAY MODE functions are also available.

Playable files

MP3/WMA disc compatibility with this player is limited as follows:

- Playable discs: CD-ROM, CD-R (650MB / 74 min. only)
CD-RW is not recommendable.
- Sampling Frequency: 44.1 kHz only
- Bit rate: WMA: 48 kbps - 192 kbps (CBR)
MP3: 32 kbps - 320 kbps (CBR)
- CD physical format: Mode 1, Mode 2 XA Form 1
- File system: ISO9660 Level 1, 2 or Joliet
- File name: A file name should be in alphabet and numbers only, and must incorporate "MP3" or "WMA" extension.
e.g. "*****.MP3", "*****.WMA"
- Total number of folders: Less than 256
- Total number of files: Less than 1000
- WMA codec version: V7 or V8 (Stereo sound only)

This DVD video player requires discs/recordings to meet certain technical standards in order to achieve optimal playback quality. Pre-recorded DVDs are automatically set to these standards. There are many different types of recordable disc formats (including CD-R containing MP3/WMA files). Given the fact that technology in this area is still maturing, Toshiba cannot guarantee that all genre of recordable discs will produce optimal playback quality. The technical criteria set out in this owner's manual are meant as a guide only.

Customers should also note that permission is required in order to download MP3 files and music from the internet. Toshiba has no right to grant such permission. Permission should always be sought from the copyright owner.

Microsoft, Windows Media, and the windows Logo are trademarks or registered trademarks of Microsoft Corporation in both the United States and other countries.



Viewing JPEG Files

You can play JPEG files that have been recorded on a CD-R or CD-ROM on the DVD video player. You can select a preferred view: a page of 9 thumbnail images, a single image view, and slide show of a selected folder.

Also, rotating, enlarging and shifting of each image can be possible.



Slide show



Thumbnail



Single image view

Starting a slide show

■ Preparations

- Prepare a disc that contains JPEG files you want to view. 53
- Make your TV shape conform to the 4:3 picture size. Only 4:3 pictures can be played regardless of the function settings via the on-screen displays of the DVD video player. If the TV is adjusted to other sizes, e.g. "WIDE" images will appear to be horizontally expanded. For details, refer to the owner's manual of your TV.

1 Press **OPEN/CLOSE** to open the disc tray.

OPEN/CLOSE



2 Place a CD that contains JPEG files on the disc tray.

3 Press **OPEN/CLOSE**.

OPEN/CLOSE

The disc tray closes, and the DVD video player reads the loaded disc.



e.g.

CD
Searching for files...

When a JPEG disc is loaded into the player, slide show starts automatically. Each picture in the disc will be displayed consecutively in a slide show presentation and will be seated to fill most of your TV screen.

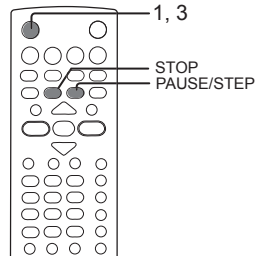

4 To quit the JPEG playback, press STOP.



- If you press STOP button, you can return to the folder list.
- Pressing the OPEN/CLOSE button to open the disc tray can also quit the playback.

- **To view a single image (To pause slide show)**
Press PAUSE/STEP

PAUSE/STEP



- **To confirm a photo number**
See [51](#) >

- **To magnify an image**
See [52](#) >

- **To rotate an image**
See [52](#) >

- **To return to the thumbnail view**
See [52](#) >

Note

- Some files may not display their own entire images depending on the size.

Viewing JPEG Files (Continued)

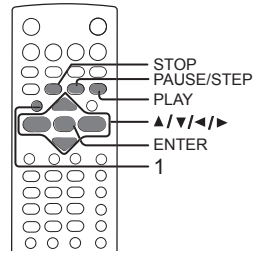

Starting from a thumbnail view and a folder list

■ To display a thumbnail view

1. Press TOP MENU during playback.

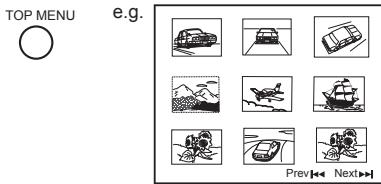

A thumbnail view appears
You can select an image to play at your preference.

2. Turn the page if necessary.

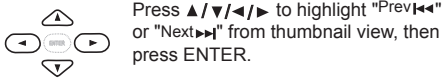

3. Select the viewing options at your preference.
Viewing a single image: see **51**

■ To display a folder list

1. Press STOP button during playback.

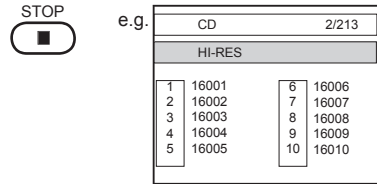

A folder list appears
You can select a folder (file) to play at your preference.

2. Press ▲/▼/◀/▶ buttons to select your desired file, and then press the ENTER or PLAY button to start playback.

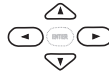

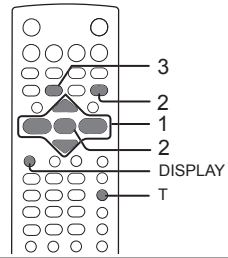

Viewing a single image

- 1** On a thumbnail view, select an image by pressing ▲/▼/◀/▶.

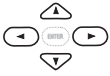

- 2** Press ENTER or PLAY.



The selected image is displayed.



To pause playback
Press PAUSE/STEP during playback.

- 3** To quit the JPEG playback, press STOP.

- If you press the PLAY button after pressing the STOP button, slide show starts.
- Pressing the OPEN/CLOSE button to open the disc tray can also quit the playback.

Note

- Some files may not display their own entire image depending on their size.

- To confirm a photo number

Press DISPLAY.

The photo number will be displayed on the TV screen.

DISPLAY



- To search a photo number

1. Press T.

The menu appears on the TV screen.

SEARCH



e.g.

Search

Track ----

2. Input the number you want to play by pressing the number buttons.

Notes

- To turn it off, press the T button.
- While a photo number image is displayed, use the number buttons to select a desired photo number and press the ENTER button. The slide show will begin from that selected image.

Viewing JPEG Files (Continued)

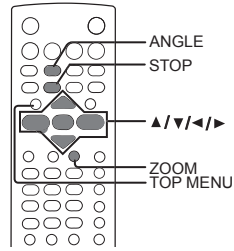

Viewing a single image

- **To magnify an image**
Press ZOOM repeatedly.



Each time you press the ZOOM button, the magnification level changes as follows:

Q 1 (The icon and monitor scope appear.) →
 Q 2 → Q 3 (Maximum) → Q Off (The icon and monitor scope disappear.)

Notes

- While changing the magnification level, you can shift the image. Press and hold the ▲/▼/◀/▶ buttons.
- Exiting an image cancels the current selection of the magnification level.



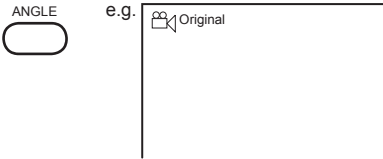

- **To rotate an image**
1. Press ANGLE during playback.



- 2. Press ANGLE repeatedly.

ANGLE
○

Each time you press the ANGLE button, you can set rotation of the image in 90 degree increments.

 Original (The icon appears) →  90 Deg CW →
 180 Deg CW →  90 Deg CCW →  Original

Note

- The DVD video player may re-display an image if you rotate it.

- **To display a folder list**
Press STOP button during playback.



You can select a folder (file) to play. See 50

- **To return to the thumbnail view**
Press TOP MENU.



See 50

JPEG files compatibility

Discs whose compatibility with this DVD video player has been confirmed by TOSHIBA are as follows. Many of these discs, when loaded, will make the DVD video player enter the automatic mode to play a prescribed folder in the disc. To play other folders, display a folder list and select a folder.

CANON Quick CD
FUJICOLOR CD
Kodak Picture CD
NORITSU QSS CD

JPEG disc compatibility with this DVD video player is limited as follows:

- Playable discs: CD-ROM, CD-R (650MB/74min. only)
CD-RW is not recommendable.
- CD physical format: Mode 1, Mode 2 XA Form 1
- File system: ISO9660 level 1, 2 or Joliet
- File name: A file name should be in alphabet and numerals only, and must incorporate "JPG" extension.
e.g. "*****.JPG"
- Total number of folders: Less than 256
- Total number of files: Less than 1000

Some files may not display their own entire image depending on the size.

Some discs may not permit this operation. Especially, the following conditions of included files will increase the disc's disability.

1. Pixels over 3072 × 2048 in height and/or width
2. File format except Exif

Function setup

You can customize the default settings to your preference.

- **Customizing the Function Settings**
- **Table of Languages**

Customizing the Function Settings

You can customize the default settings to your preference.

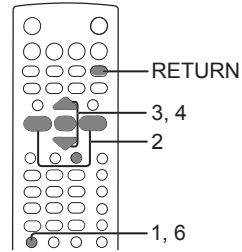

Setting procedure

1 Press **SETUP** during stop.

The following on-screen display appears.

Language Video Audio Parental

2 Press **◀/▶** to select a item for the setting you want to change, and then press **ENTER**.
(See the next page)

Language	Language settings
Video	Picture output settings
Audio	Output sound settings
Parental	Parental lock settings Initial setup

3 Press **▲/▼** to select the setting you want to change, then press **ENTER**.

4 Change the selection by **▲/▼**, by referring to the corresponding pages (**58**), then press **ENTER**.





5 Change step 3 and 4 to change other setting.



To select another operation, go back to step 2.

6 Press **SETUP**.
The on-screen display disappears.



- To return to the previous display
Press the RETURN button.
-

- Notes**
- To quit the procedure, press the **SETUP** button to turn off the on-screen display.
 - The **SETUP** button can only function during stop.

Language			
OSD Menu		To select a preferred language for on-screen displays.	58
Subtitle		To select a preferred language for subtitles	58
Audio		To select a preferred language for the sound track	58
DVD Menu		To select a preferred language for the disc menus.	58

Video			
TV Shape		To select a picture size according to the aspect ratio of your TV.	59
Video Output		To select a proper video output mode corresponding to your connected TV.	59

Audio			
Digital Output		To select an output sound format corresponding to your system connection.	60

Parental			
Password		To turn the parental lock function on or off.	60
Parental		When the parental lock feature is activated, the settings can be changed	61
Default		To install the initial system setting.	61

Customizing the Function Settings (continued)

Setting details

Language

Language	Video	Audio	Parental
OSD Menu	English		
Subtitle	English		
Audio	English		
DVD Menu	English		

OSD Menu DVD VCD CD

English: To view On-screen displays in English.
 Français: To view On-screen displays in French.
 Español: To view On-screen displays in Spanish.

Subtitle DVD

English: To display subtitles in English.
 Français: To display subtitles in French.
 Español: To display subtitles in Spanish.
 Auto: To display prior subtitle recorded on the disc.
 Off: To disable subtitles.

Notes

- Some DVD video discs may be set to display subtitles in a different language than you selected. A prior subtitle language may be programmed on the disc.
- Some DVD video discs allow you to change subtitle selections only via the disc menu. If this is case, access the disc menu and choose the appropriate subtitle language from the selection on the disc menu.

Audio DVD

English: To play sound track in English.
 Français: To play sound track in French.
 Español: To play sound track in Spanish.

Note

- Some DVD video discs may be played in a different language than you selected. A prior language may be programmed on the disc.

DVD Menu DVD

English: To display disc menus in English.
 Français: To display disc menus in French.
 Español: To display disc menus in Spanish.

Note

- Some DVD video discs may not include your pre-select language. In this case, the DVD video player automatically displays a prior language programmed on the disc.

Video

Language **Video** Audio ParentalTV Shape **4:3 Letter Box**
Video Output CVBSTV Shape **DVD**

4:3 Pan Scan: Select when a standard 4:3 TV is connected. Displays pictures cropped to fill your TV screen. Either or both sides of the picture are cut off.



4:3 Letter Box: Select when a standard 4:3 TV is connected. Displays theatrical images with masking bars above and below the picture.



16:9 Wide Select when a 16:9 wide TV is connectd.

**Notes**

- The displayable picture size is preset on the DVD video disc. Therefore, the playback picture of some DVD video discs may not conform the picture size you selected.
- If you select "16:9" and own a 4:3 TV set, the DVD playback picture will be horizontally distorted during playback. Images will appear to be horizontally compressed. Always be sure that your TV shape conforms to the actual TV in use.

Video Output **DVD** **VCD**

CVBS: Select when you connect your DVD video player with VIDEO OUT jack.

Y PB PR: Select when you connect your DVD video player with Y, PB, PR jacks.

Note

When "Y PB PR" is set and you select the progressive output signal, no video signals are output from the VIDEO OUT jack and the S VIDEO OUT jack.

Customizing the Function Settings (continued)

Setting details

Audio

Language	Video	Audio	Parental
Digital Output	PCM		

Digital Output

Select the output sound format corresponding to your system connection.

For details of sound recording systems, see [42](#)

PCM: Select when connected to a 2 channel digital stereo amplifier. See [22](#)
The DVD video player outputs sounds in the PCM 2ch format when you play a DVD video disc recorded on the Dolby Digital, MPEG1 or MPEG2 recording system.

Bitstream: Select when connected to an amplifier equipped with a Dolby Digital, DTS, decoder. See [21](#) [22](#)

Note

When you make a connection to a TV, or Dolby Surround Pro Logic or stereo system via the analog audio jacks, select "Bitstream" or "PCM".



Parental



Language	Video	Audio	Parental
Password	---		
Parental	8. Adult		
Default	No		

Password

DVD video discs equipped with the parental lock function are rated according to their content. The contents allowed by a parental lock level and the way a DVD video disc can be controlled may vary from disc to disc. For example, if the disc allowed you could edit out violent scenes unsuitable for children and replace them with more suitable scenes, or lock out playback of the disc altogether.

- DVD video discs may or may not respond to the parental lock settings. This is not a defect in the DVD video player. Make sure this function works with your DVD video discs.

-  :The parental lock feature does not function. After pressing the ENTER button, follow the step 1) below.
-  :To activate the parental lock feature or change the settings. After pressing the ENTER button, follow steps 1) - 3)

- 1) Press the number buttons to create a personal 4-digit security code, then press ENTER. The pre-set password is 0000. If you make a mistake before pressing the ENTER button, press the CLEAR button and enter your 4-digit security code again.
- 2) Select "Parental" by pressing the  / , buttons.
- 3) Press the ENTER button repeatedly to select the playback level as your preference.

(continued)

Parental Language Video Audio **Parental**

Password	----	
Parental	8. Adult	
Default	No	

You cannot play DVD video discs rated higher than the level you selected unless you cancel the parental lock function.

For example, when you select 7, discs rated higher than level 7 are locked out and cannot be played.

The parental lock level is equivalent to the following ratings.

1. Kid Safe
2. G
3. PG
4. PG-13
5. PG-R
6. R
7. NC-17
8. Adult

The parental lock level for other countries/areas than U.S. are included for future use. Check the appropriate parental lock level when you buy a DVD video disc equipped with the parental lock feature in the future.

When the parental feature is activated, you can change the parental lock level according to your preference. For details, see [60](#).



■ Forgetting your password

If you forget the password, you can erase your current password by pressing number button 0 on the remote control four times, then press ENTER button to confirm the setting.

Default   Language Video Audio **Parental**

Password	----	
Parental	8. Adult	
Default	Yes	

If you want to return the initial settings such as Language, Video, Audio and etc. to the factory default, do the following:

- 1) Press the / buttons to select "Default", and press the ENTER button.
- 2) Select "Yes" according to your preference, and press the ENTER button.

Note:

When you reset the DVD vide player to the factory default, the DVD video player will take 3-5 seconds to reset.

Table of Languages

Table of languages and their abbreviations

Abbreviation	Language	Abbreviation	Language	Abbreviation	Language
---	No alternate language	GN	Guarani	PT	Portuguese
CHI (ZH)	Chinese	GU	Gujarati	QU	Quechua
DUT (NL)	Dutch	HA	Hausa	RM	Rhaeto-Romance
ENG (EN)	English	HI	Hindi	RN	Kirundi
FRE (FR)	French	HR	Croatian	RO	Rumanian
GER (DE)	German	HU	Hungarian	RU	Russian
ITA (IT)	Italian	HY	Armenian	RW	Kinyarwanda
JPN (JA)	Japanese	IA	Interlingua	SA	Sanskrit
KOR (KO)	Korean	IE	Interlingue	SD	Sindhi
MAY (MS)	Malay	IK	Inupiak	SG	Sango
SPA (ES)	Spanish	IN	Indonesian	SH	Serbo-Croatian
AA	Afar	IS	Icelandic	SI	Singhatese
AB	Abkhazian	IW	Hebrew	SK	Slovak
AF	Afrikaans	JI	Yiddish	SL	Slovenian
AM	Amharic	JW	Javanese	SM	Samoan
AR	Arabic	KA	Georgian	SN	Shona
AS	Assamese	KK	Kazakh	SO	Somali
AY	Aymara	KL	Greenlandic	SQ	Albanian
AZ	Azerbaijani	KM	Cambodian	SR	Serbian
BA	Bashkir	KN	Kannada	SS	Siswati
BE	Belorussian	KS	Kashmiri	ST	Sesotho
BG	Bulgarian	KU	Kurdish	SU	Sundanese
BH	Bihari	KY	Kirghiz	SV	Swedish
BI	Bislama	LA	Latin	SW	Swahili
BN	Bengali, Bangla	LN	Lingala	TA	Tamil
BO	Tibetan	LO	Laotian	TE	Telugu
BR	Breton	LT	Lithuanian	TG	Tajik
CA	Catalan	LV	Latvian, Lettish	TH	Thai
CO	Corsican	MG	Malagasy	TI	Tigrinya
CS	Czech	MI	Maori	TK	Turkmen
CY	Welsh	MK	Macedonian	TL	Tagalog
DA	Danish	ML	Malayalam	TN	Setswana
DZ	Bhutani	MN	Mongolian	TO	Tongan
EL	Greek	MO	Moldavian	TR	Turkish
EO	Esperanto	MR	Marathi	TS	Tsonga
ET	Estonian	MT	Maltese	TT	Tatar
EU	Basque	MY	Burmese	TW	Twi
FA	Persian	NA	Nauru	UK	Ukra
FI	Finnish	NE	Nepali	UR	Urdu
FJ	Fiji	NO	Norwegian	UZ	Uzbek
FO	Faroese	OC	Occitan	VI	Vietnamese
FY	Frisian	OM	(Afan) Oromo	VO	Volapuk
GA	Irish	OR	Oriya	WO	Wolof
GD	Scottish Gaelic	PA	Panjabi	XH	Xhosa
GL	Galician	PL	Polish	YO	Yoruba
		PS	Pashto, Pushto	ZU	Zulu

Others

- Before calling Service Personnel
- Specifications
- LIMITED UNITED STATES WARRANTY DVD PLAYERS- EXCHANGE WARRANTY

Before Calling Service Personnel

Check the following guide for the possible cause of a problem before contacting service.

Symptoms and correction

Symptom	Cause	Correction	Page
No power.	<ul style="list-style-type: none"> The power plug is disconnected. 	<ul style="list-style-type: none"> Connect the power plug securely into the wall outlet. 	18
The DVD video player turned off by itself.	<ul style="list-style-type: none"> The automatic power off function turned the unit off. 	<ul style="list-style-type: none"> Press the PLAY button. 	24
No picture.	<ul style="list-style-type: none"> The TV is not set to receive DVD signal output. 	<ul style="list-style-type: none"> Select the appropriate video input mode on the TV so the picture from the DVD video player appears on the TV screen. 	24
	<ul style="list-style-type: none"> The video cable is not connected correctly. 	<ul style="list-style-type: none"> Connect the video cable correctly into the appropriate jacks. 	18, 19
No sound.	<ul style="list-style-type: none"> The equipment connected with the audio cable is not set to receive DVD signal output. 	<ul style="list-style-type: none"> Select the correct input mode of the audio receiver so you can listen to the sound from the DVD video player. 	24
	<ul style="list-style-type: none"> The audio cable is not connected correctly. 	<ul style="list-style-type: none"> Connect the audio cable correctly into the appropriate jacks. 	18-22
	<ul style="list-style-type: none"> The audio receiver or TV is turned off. 	<ul style="list-style-type: none"> Turn on the equipment connected with the audio cable. 	24
	<ul style="list-style-type: none"> The setting of output sound format is incorrect. 	<ul style="list-style-type: none"> Select the proper audio setting. 	42, 56, 60
The playback picture has occasional distortion.	<ul style="list-style-type: none"> The disc is dirty. 	<ul style="list-style-type: none"> Eject the disc and clean it. 	8
	<ul style="list-style-type: none"> It is in fast forward or fast reverse playback. 	<ul style="list-style-type: none"> Sometimes a small amount of picture distortion may appear. This is not a malfunction. 	-
Brightness is unstable or noises are present in the playback pictures.	<ul style="list-style-type: none"> The effect of copy protection. 	<ul style="list-style-type: none"> Connect the DVD video player directly to the TV. Avoid connecting the DVD video player to a VCR or TV/VCR combination. 	18
The DVD video player does not start playback.	<ul style="list-style-type: none"> No disc is inserted. 	<ul style="list-style-type: none"> Insert a disc. 	24
	<ul style="list-style-type: none"> An unplayable disc is inserted. 	<ul style="list-style-type: none"> Insert a playable disc. (Check the disc type and color system.) 	10
	<ul style="list-style-type: none"> The disc is placed upside down. 	<ul style="list-style-type: none"> Place the disc with playback side down. 	24
	<ul style="list-style-type: none"> The disc is not placed within the guide. 	<ul style="list-style-type: none"> Place the disc correctly inside the guide on the disc tray. 	24
	<ul style="list-style-type: none"> The disc is dirty. 	<ul style="list-style-type: none"> Clean the disc. 	9
	<ul style="list-style-type: none"> The parental lock function is set. 	<ul style="list-style-type: none"> Cancel the parental lock function or change the parental lock level. 	56, 60, 61
Playback does not follow the course of the disc's program.	<ul style="list-style-type: none"> It is in the mode of repeat playback, memory playback, etc. 	<ul style="list-style-type: none"> These operations may prevent a proper progress of the contents. 	-
Buttons do not work.	<ul style="list-style-type: none"> Power supply fluctuations or other abnormalities such as static electricity may interrupt correct operations. 	<ul style="list-style-type: none"> Press and hold the ON/STANDBY button on the front panel for more than about 3 seconds. The DVD video player turns off. Press the button again to turn it on. If the buttons still do not work, disconnect the power plug and insert it into the wall outlet again. 	-
The remote control does not work properly.	<ul style="list-style-type: none"> The remote control is not pointed at the remote sensor of the DVD video player. 	<ul style="list-style-type: none"> Point the remote control at the remote sensor of the DVD video player. 	15
	<ul style="list-style-type: none"> The remote control is too far from the DVD video player. 	<ul style="list-style-type: none"> Operate the remote control within about 7 m. 	15
	<ul style="list-style-type: none"> The batteries in the remote control are exhausted. 	<ul style="list-style-type: none"> Replace the batteries with new ones. 	15

DVD video player/outputs/supplied accessories

DVD Video Player

Power supply	120 V AC, 60Hz
Power consumption	15W
Mass	1.7kg
External dimensions	430×51×235mm(W/H/D)
Signal system	Standard NTSC
Laser	Semiconductor laser, wavelength 650 nm
Frequency range	DVD linear sound: 48 kHz sampling 20 Hz to 20kHz 96 kHz sampling 20 Hz to 20kHz
Signal-to noise ratio	More than 90dB
Audio dynamic range	More than 80dB
Harmonic distortion	Less than 10%
Wow and flutter	Below measurable level (less than ±0.001%(W.PEAK))
Operating conditions	Temperature: 5°C to 35°C, Operation status: Horizontal

Outputs

Video output	1.0V(p-p), 75 Ω, negative sync., pin jack × 1
S video output	(Y) 0.7 ± 0.14V, 75 Ω, negative sync., Mini DIN 4-pin × 1 (C) 0.3± 0.06V(p-p), 75 Ω
Component video output	(Y) 0.7±0.14V, 75 Ω, negative sync., pin jack × 1 (Pb)(Pr) 0.7±0.14V(p-p),75 Ω, pin jack × 2
Audio output (BITSTREAM/PCM COAXIAL)	0.5V(p-p),75 Ω, pin jack × 1
Audio output (ANALOG)	1.0~2.0V (rms), 10kΩ, pin jack(L,R) × 1

Supplied Accessories

Audio/video cable	1
Remote control (SE-R0127).....	1
Batteries (AAA).....	2
Stop Return Sheet	1
Owner's Manual (This booklet)	1

- Designs and specifications are subject to change without notice.

LIMITED UNITED STATES WARRANTY DVD PLAYERS- EXCHANGE WARRANTY

Toshiba America Consumer Products, L.L.C. ("TACP") makes the following limited warranties to original consumers in the United States. THESE LIMITED WARRANTIES EXTEND TO THE ORIGINAL CONSUMER PURCHASER OR ANY PERSON RECEIVING THIS DVD PLAYER AS A GIFT FROM THE ORIGINAL CONSUMER PURCHASER AND TO NO OTHER PURCHASER OR TRANSFEREE.

PRODUCTS PURCHASED IN THE U.S.A. AND USED IN CANADA ARE NOT COVERED BY THESE WARRANTIES.
PRODUCTS PURCHASED IN CANADA AND USED IN THE U.S.A. ARE NOT COVERED BY THESE WARRANTIES.

Limited Ninety (90) Day Warranty

TACP warrant this DVD PLAYER and its parts against defects in materials or workmanship for a period of ninety (90) days after the date of original retail purchase . DURING THE FIRST 90 DAYS FROM THE PURCHASE DATE, TACP WILL EXCHANGE A DEFECTIVE DVD PLAYER WITH A NEW OR REFURBISHED PLAYER WITHOUT CHARGE TO YOU. YOU MUST CONTACT TOSHIBA'S CONSUMER SOLUTIONS CENTER FOR INSTRUCTIONS ON HOW TO PROCESS YOUR IN WARRANTY EXCHANGE REQUEST. THE CONSUMER IS RESPONSIBLE FOR ALL INBOUND TRANSPORTATION AND INSURANCE CHARGES FOR THE DVD PLAYER TO THE EXCHANGE CENTER. DURING THE PERIOD FROM 91 DAYS AND BEYOND, FROM THE PURCHASE DATE, TACP WILL EXCHANGE A DEFECTIVE DVD PLAYER WITH A NEW OR REFURBISHED PLAYER FOR A NOMINAL FEE. YOU MUST CONTACT TOSHIBA'S CONSUMER SOLUTIONS CENTER FOR INSTRUCTIONS ON HOW TO PROCESS YOUR EXCHANGE REQUEST. THE CONSUMER IS RESPONSIBLE FOR ALL INBOUND TRANSPORTATION AND INSURANCE CHARGES FOR THE DVD PLAYER TO THE EXCHANGE CENTER.

*Rental Units

The warranty for rental units begins with the first rental or thirty (30) days from the date of shipment to the rental firm, whichever comes first.

*Commercial Units

DVD PLAYERS sold and used for commercial purposes have a limited ninety (90) day warranty for all parts, labor.

Owner's Manual and Demographic Card

You should read this owner's manual thoroughly before operating this DVD PLAYER. You should complete and mail the enclosed Demographic card within ten days after you, or the person who has given you this product as a gift, purchased this DVD PLAYER. This is one way to enable TACP to provide you with better customer service and improved products. Failure to return the Demographic card will not affect your rights under this warranty.

Your Responsibility

THE ABOVE WARRANTIES ARE SUBJECT TO THE FOLLOWING CONDITIONS:

- (1) You must provide your bill of sale or other proof of purchase.
- (2) All warranty servicing of this DVD PLAYER must be made by an Authorized TACP Service Station.
- (3) The warranties from TACP are effective only if the DVD PLAYER is purchased and operated in the U.S.A. or Puerto Rico.
- (4) Labor service charges for set installation, set up, adjustment of customer controls and installation or repair of antenna systems are not covered by these warranties. Reception problems caused by inadequate antenna systems are your responsibility.
- (5) Warranties extend only to defects in materials or workmanship as limited above and do not extend to any DVD PLAYER or parts which have been lost or discarded by you or to damage to DVD PLAYER or parts caused by misuse, accident, Acts of God, such as lightning or fluctuations in electric power, improper installation, improper maintenance or use in violation of instructions furnished by TACP; or to units which have been modified or had the serial number removed, altered, defaced or rendered illegible.

How to Obtain Warranty Services

If, after following all of the operating instructions in this manual and checking the section "Troubleshooting", you find that service is needed:

- (1) For instructions on how to obtain warranty service for exchange program DVD Players, contact TACP'S toll free Call Center at 1-866-583-7353.
- (2) Include your bill of sale or other proof of purchase along with the DVD player, when sending it to the Authorized TACP Service Station SPECIFIED by TACP'S Call Center. You must pay for all transportation and insurance charges for the DVD Product to and from the Service Station.

For additional information, visit TACP's web site:

www.tacp.toshiba.com

ALL WARRANTIES IMPLIED BY THE LAW OF ANY STATE OF THE U.S.A., INCLUDING THE IMPLIED WARRANTIES OF MERCHANTABILITY AND FITNESS FOR A PARTICULAR PURPOSE, ARE EXPRESSLY LIMITED TO THE DURATION OF THE LIMITED WARRANTIES SET FORTH ABOVE. WITH THE EXCEPTION OF ANY WARRANTIES IMPLIED BY THE LAW OF ANY STATE OF THE U.S.A. AS HEREBY LIMITED, THE FOREGOING WARRANTY IS EXCLUSIVE AND IN LIEU OF ALL OTHER WARRANTIES, GUARANTEES, AGREEMENTS AND SIMILAR OBLIGATIONS OF TACP OR THIRTS WITH RESPECT TO THE REPAIR OR REPLACEMENT OF ANY PARTS. IN NO EVENT SHALL TACP BE LIABLE FOR CONSEQUENTIAL OR INCIDENTAL DAMAGES.

No person, agent, distributor, dealer or company is authorized to change, modify or extend the terms of these warranties in any manner whatsoever. The time within which action must be commenced to enforce any obligation of TACP arising under this warranty or under any law of the United States or of any state thereof is hereby limited to 90 days from the date you discovered or should have discovered, the defect. This limitation does not apply to implied warranties arising under the law of any state of the U.S.A.

THIS WARRANTY GIVES YOU SPECIFIC LEGAL RIGHTS, AND YOU MAY ALSO HAVE OTHER RIGHTS WHICH MAY VARY FROM STATE TO STATE IN THE U.S.A. SOME STATES OF THE U.S.A. DO NOT ALLOW LIMITATIONS ON HOW LONG AN IMPLIED WARRANTY LASTS, WHEN AN ACTION MAY BE BROUGHT, OR THE EXCLUSION OR LIMITATION OF INCIDENTAL OR CONSEQUENTIAL DAMAGES, SO THE AFOREMENTIONED LIMITATIONS OR EXCLUSIONS MAY NOT APPLY TO YOU UNDER SUCH CIRCUMSTANCES.

TOSHIBA

Printed in China