

# TOSHIBA

OWNER'S MANUAL

Video Cassette Recorder

Hi-Fi **VHS**

# M-671

**VCR Plus+**  
w/Cable Channel  
Changer

INTRODUCTION 1

PREPARATION 8

PLAYBACK 15

RECORDING 20

ADDITIONAL  
INFORMATION 31

 This publication is printed  
on recycled paper

# SAFETY PRECAUTIONS

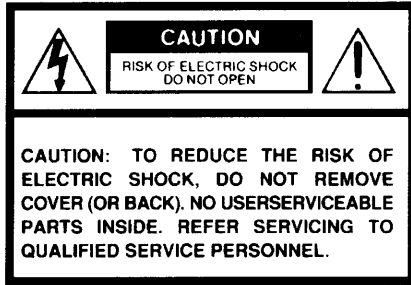

The lightning flash with arrowhead symbol, within an equilateral triangle, is intended to alert the user to the presence of uninsulated "dangerous voltage" within the product's enclosure that may be of sufficient magnitude to constitute a risk of electric shock to persons.

The exclamation point within an equilateral triangle is intended to alert the user to the presence of important operating and maintenance (servicing) instructions in the literature accompanying the appliance.

**WARNING: TO REDUCE THE RISK OF FIRE OR ELECTRIC SHOCK, DO NOT EXPOSE THIS APPLIANCE TO RAIN OR MOISTURE. DANGEROUS HIGH VOLTAGES ARE PRESENT INSIDE THE ENCLOSURE. DO NOT OPEN THE CABINET. REFER SERVICING TO QUALIFIED PERSONNEL ONLY.**

**CAUTION: TO PREVENT ELECTRIC SHOCK, DO NOT USE THIS (POLARIZED) PLUG WITH AN EXTENSION CORD, RECEPTACLE OR OTHER OUTLET UNLESS THE BLADES CAN BE FULLY INSERTED TO PREVENT BLADE EXPOSURE.**

USER-INSTALLER CAUTION: YOUR AUTHORITY TO OPERATE THIS FCC CERTIFIED EQUIPMENT COULD BE VOIDED IF YOU MAKE CHANGES OR MODIFICATIONS NOT EXPRESSLY APPROVED BY THIS PARTY RESPONSIBLE FOR COMPLIANCE TO PART 15 OF THE FCC RULES.

## Note to CATV system installer:

This reminder is provided to call the CATV system installer's attention to Article 820-40 of the NEC that provides guidelines for proper grounding and, in particular, specifies that the cable ground shall be connected to the grounding system of the building, as close to the point of cable entry as practical.

## Copyright

It is permissible to record television programs, film, video tapes and other material only in the event that third party copyrights and other rights are not violated.

# IMPORTANT PRECAUTIONS

## Save Original Packing Materials

The original shipping carton and packing materials will come in handy if you ever have to ship your VCR. For maximum protection, repack the set as it was originally packed at the factory.

## Avoid Volatile Liquid

Do not use volatile liquids, such as an insect spray, near the unit.  
Do not leave rubber or plastic products touching the unit for a long time. They will mar the finish.

## Moisture Condensation

Never operate this unit immediately after moving it from a cold location to a warm location. When the VCR is exposed to such a change in temperature, moisture may condense on the cylinder inside, one of its most crucial internal parts. To prevent the VCR from possible damage, do not use the unit for at least 2 hours when there is an extreme or sudden change in temperature.

## Compatibility

This video cassette recorder (VCR) is compatible with any other VCR bearing the  mark. HQ VHS equipment is also compatible with existing, non-HQ VHS equipment.

In the spaces provided below, record the Model and Serial No. located at the rear of your video cassette recorder.

Model No. \_\_\_\_\_ Serial No. \_\_\_\_\_

Retain this information for future reference.

# IMPORTANT SAFETY INSTRUCTIONS

**CAUTION: PLEASE READ AND OBSERVE ALL WARNINGS AND INSTRUCTIONS GIVEN IN THIS OWNER'S MANUAL AND THOSE MARKED ON THE UNIT. RETAIN THIS BOOKLET FOR FUTURE REFERENCE.**

This set has been designed and manufactured to assure personal safety. Improper use can result in electric shock or fire hazard. The safeguards incorporated in this unit will protect you if you observe the following procedures for installation, use and servicing. This unit is fully transistorized and does not contain any parts that can be repaired by the user.

**DO NOT REMOVE THE CABINET COVER, OR YOU MAY BE EXPOSED TO DANGEROUS VOLTAGE. REFER SERVICING TO QUALIFIED SERVICE PERSONNEL ONLY.**

**1. Read owner's manual**

After unpacking this product, read the owner's manual carefully, and follow all the operating and other instructions.

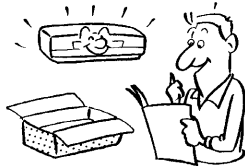

**5. Heat**

The product should be situated away from heat sources such as radiators, heat registers, stoves, or other products (including amplifiers) that produce heat.

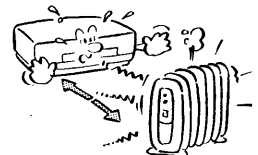

**2. Power Sources**

This product should be operated only from the type of power source indicated on the marking label. If you are not sure of the type of power supply to your home, consult your product dealer or local power company. For products intended to operate from battery power, or other sources, refer to the operating instructions.

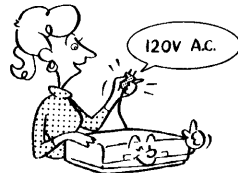

**6. Water and Moisture**

Do not use this product near water - for example, near a bath tub, wash bowl, kitchen sink, or laundry tub; in a wet basement; or near a swimming pool and the like.

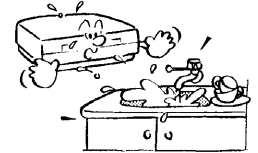

**3. Grounding or Polarization**

This product may be equipped with a polarized alternating current line plug (a plug having one blade wider than the other). This plug will fit into the power outlet only one way. This is a safety feature. If you are unable to insert the plug fully into the outlet, try reversing the plug. If the plug should still fail to fit, contact your electrician to replace your obsolete outlet. Do not defeat the safety purpose of the polarized plug.

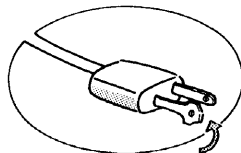

**7. Cleaning**

Unplug this product from the wall outlet before cleaning. Do not use liquid cleaners or aerosol cleaners. Use a damp cloth for cleaning.

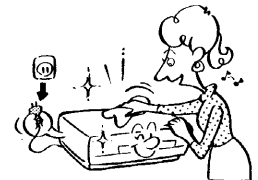

**4. Ventilation**

Slots and openings in the cabinet are provided for ventilation and to ensure reliable operation of the product and to protect it from overheating, and these openings must not be blocked or covered. The openings should never be blocked by placing the product on a bed, sofa, rug or other similar surface. This product should not be placed in a built-in installation such as a bookcase or rack unless proper ventilation is provided or the manufacturer's instructions have been adhered to.



**8. Power-Cord Protection**

Power-supply cords should be routed so that they are not likely to be walked on or pinched by items placed upon or against them, paying particular attention to cords at plugs, convenience receptacles, and the point where they exit from the product.



**9. Overloading**

Do not overload wall outlets; extension cords, or integral convenience receptacles as this can result in a risk of fire or electric shock.

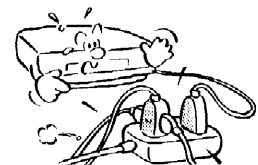

# IMPORTANT SAFETY INSTRUCTIONS

## 10. Outdoor Antenna Grounding

If an outside antenna or cable system is connected to the product, be sure the antenna or cable system is grounded so as to provide some protection against voltage surges and built-up static charges. Article 810 of the National Electrical Code, ANSI/NFPA 70, provides information with regard to proper grounding of the mast and supporting structure, grounding of the lead-in wire to an antenna discharge unit, size of grounding conductors, location of antenna-discharge unit, connection to grounding electrodes, and requirements for the grounding electrode.

### EXAMPLE OF ANTENNA GROUNDING AS PER NATIONAL ELECTRICAL CODE

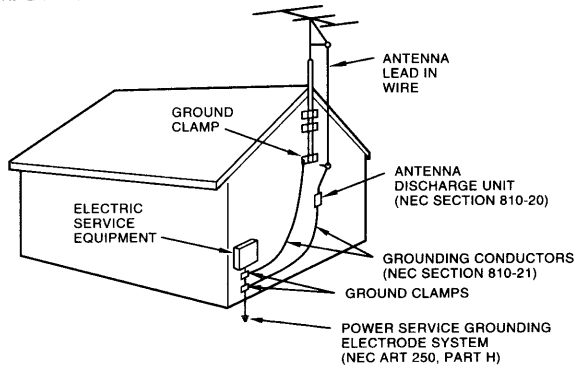

S2898A

## 11. Power Lines

An outside antenna system should not be located in the vicinity of overhead power lines or other electric light or power circuits, or where it can fall into such power lines or circuits. When installing an outside antenna system, extreme care should be taken to keep from touching such power lines or circuits as contact with them might be fatal.

## 12. Lightning

For added protection for this product during storm, or when it is left unattended and unused for long periods of time, unplug it from the wall outlet and disconnect the antenna or cable system. This will prevent damage to the product due to lightning and power-line surges.

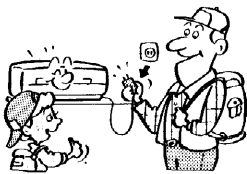

## 13. Object and Liquid Entry

Never push objects of any kind into this product through openings as they may touch dangerous voltage points or short-out parts that could result in a fire or electric shock. Never spill liquid of any kind on the product.

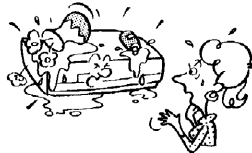

## 14. Attachments

Do not use attachments not recommended by the product manufacturer as they may cause hazards.

## 15. Accessories

Do not place this product on an unstable cart, stand, tripod, bracket, or table. The product may fall, causing serious injury to a child or adult, and serious damage to the product. Use only with a cart, stand, tripod, bracket, or table recommended by the manufacturer, or sold with the product. Any mounting of the product should follow the manufacturer's instructions, and should use a mounting accessory recommended by the manufacturer.



A product and cart combination should be moved with care. Quick stops, excessive force, and uneven surfaces may cause the product and cart combination to overturn.

## 16. Damage Requiring Service

Unplug this product from the wall outlet and refer servicing to qualified service personnel under the following conditions:

- When the power-supply cord or plug is damaged.
- If liquid has been spilled, or objects have fallen into the product.
- If the product has been exposed to rain or water.
- If the product does not operate normally by following the operating instructions. Adjust only those controls that are covered by the operating instructions as an improper adjustment of other controls may result in damage and will often require extensive work by a qualified technician to restore the product to its normal operation.
- If the product has been dropped or damaged in any way.
- When the product exhibits a distinct change in performance - this indicates a need for service.

## 17. Servicing

Do not attempt to service this product yourself as opening or removing covers may expose you to dangerous voltage or other hazards. Refer all servicing to qualified service personnel.

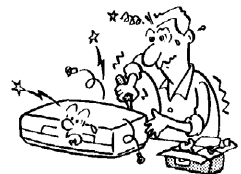

## 18. Replacement Parts

When replacement parts are required, be sure the service technician has used replacement parts specified by the manufacturer or have the same characteristics as the original part. Unauthorized substitutions may result in fire, electric shock, or other hazards.

## 19. Safety Check

Upon completion of any service or repairs to this product, ask the service technician to perform safety checks to determine that the product is in proper operating condition.

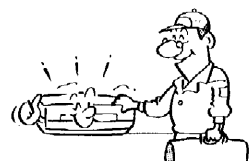

## 1

### INTRODUCTION

Provides important notes and general explanation of the VCR, including names of the buttons, jacks, etc.

SAFETY PRECAUTIONS .....	1
IMPORTANT PRECAUTIONS .....	1
IMPORTANT SAFETY INSTRUCTIONS .....	2
CONTENTS .....	4
For convenient use of this manual .....	5
IDENTIFICATION OF CONTROLS .....	6
• Front Panel	
• Remote Control	
• Rear Panel	
• VCR Display	

INTRODUCTION

## 2

### PREPARATION

Explains what you need to do before operating the VCR.

HOW TO USE THE REMOTE CONTROL .....	8
CONNECTIONS .....	9
MULTI BRAND REMOTE CONTROL .....	11
INITIAL SETTINGS USING ON-SCREEN DISPLAY .....	12
• Setting the Language	
• Setting the Clock	
STORING CHANNELS ON THE VCR .....	13

PREPARATION

## 3

### PLAYBACK

Explains variable functions concerning playback.

INTEL-A-PLAY .....	15
VIDEO CASSETTE USE .....	15
PLAYBACK .....	16
VARIABLE SPEED PLAYBACK .....	17
• Picture Search	
• Still Picture	
• Slow-motion Picture	
• Double Speed Playback	
• Frame Advance	
USEFUL FUNCTIONS IN TAPE OPERATION .....	19
• Counter Function	
• Index Search Function	
• Tape Remaining Time	

PLAYBACK

## 4

### RECORDING

Explains recording functions.

RECORDING A TV PROGRAM .....	20
• Watching a TV Program While Recording Another	
• One-touch Timer Recording	
TIMER PROGRAM RECORDING .....	21
VCR Plus+ SET-UP .....	23
VCR Plus+ RECORDING .....	25
CABLE BOX SET-UP .....	27
MTS BROADCAST COMPATIBILITY .....	29
TAPE COPYING .....	30
SIMULCAST RECORDING .....	30

RECORDING

## 5

### ADDITIONAL INFORMATION

BEFORE CALLING SERVICE PERSONNEL .....	31
SPECIFICATIONS .....	32
ACCESSORIES .....	32
LIMITED WARRANTY .....	Back cover

ADDITIONAL INFORMATION

# For convenient use of this manual

Fold out the leaf of this page.

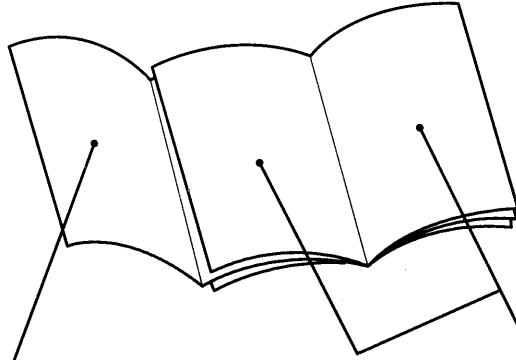

Each part has a number for identification, which is used also in the texts for reference. You can easily locate the parts using these numbers.

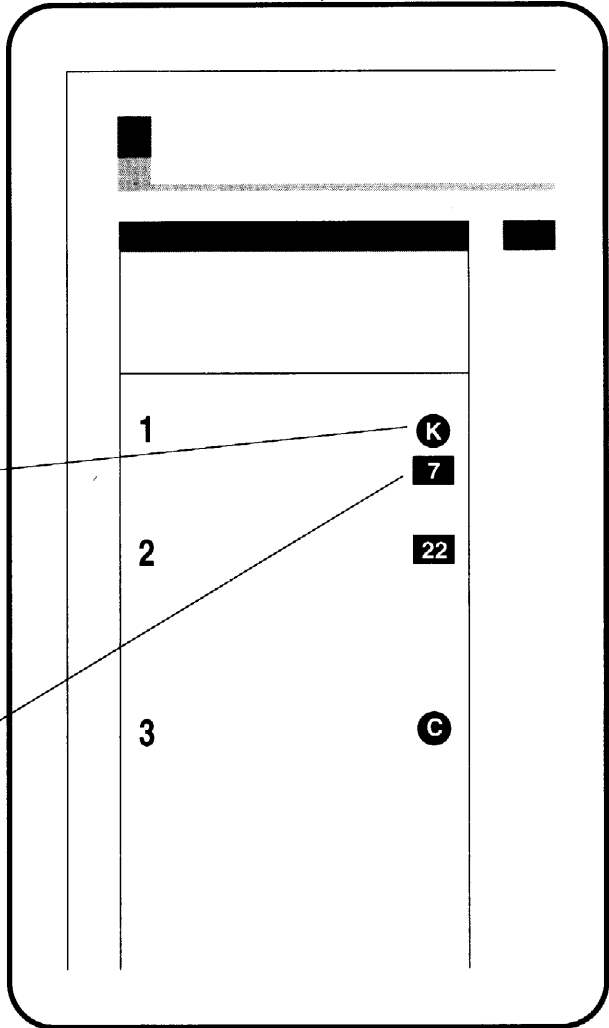
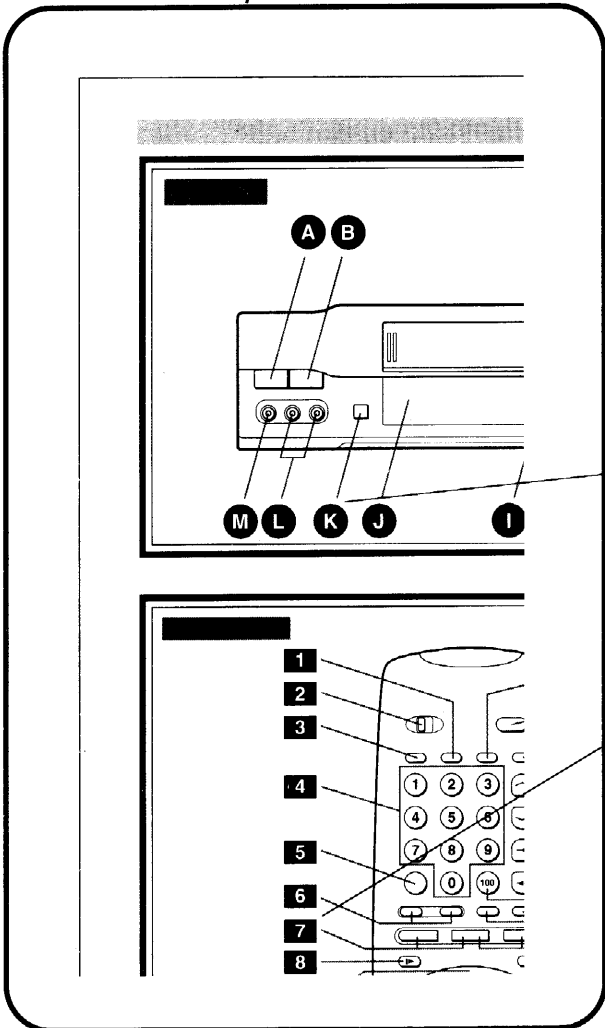

- Numbers in the circle refer to the parts on the front panel: those in the square to the remote control.

# 1 IDENTIFICATION OF CONTROLS

## Front Panel

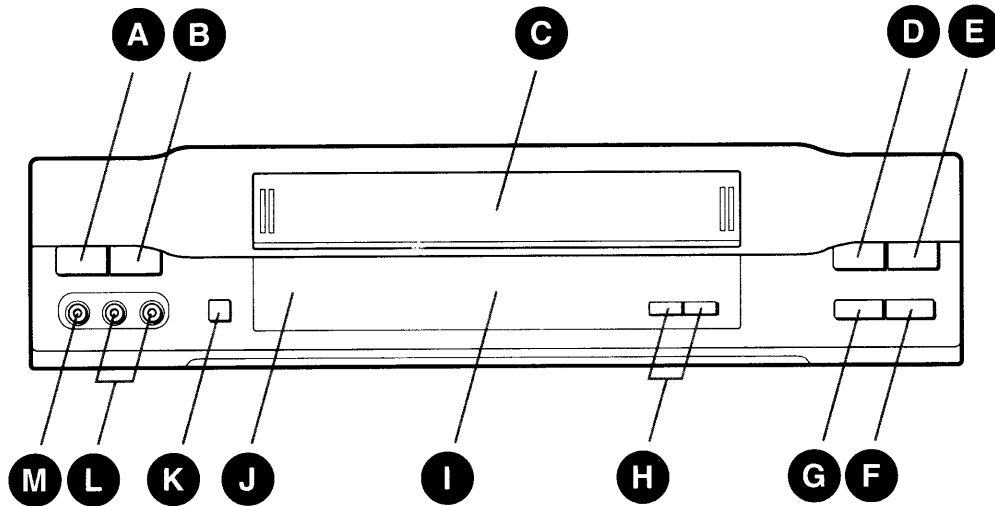

## Remote Control

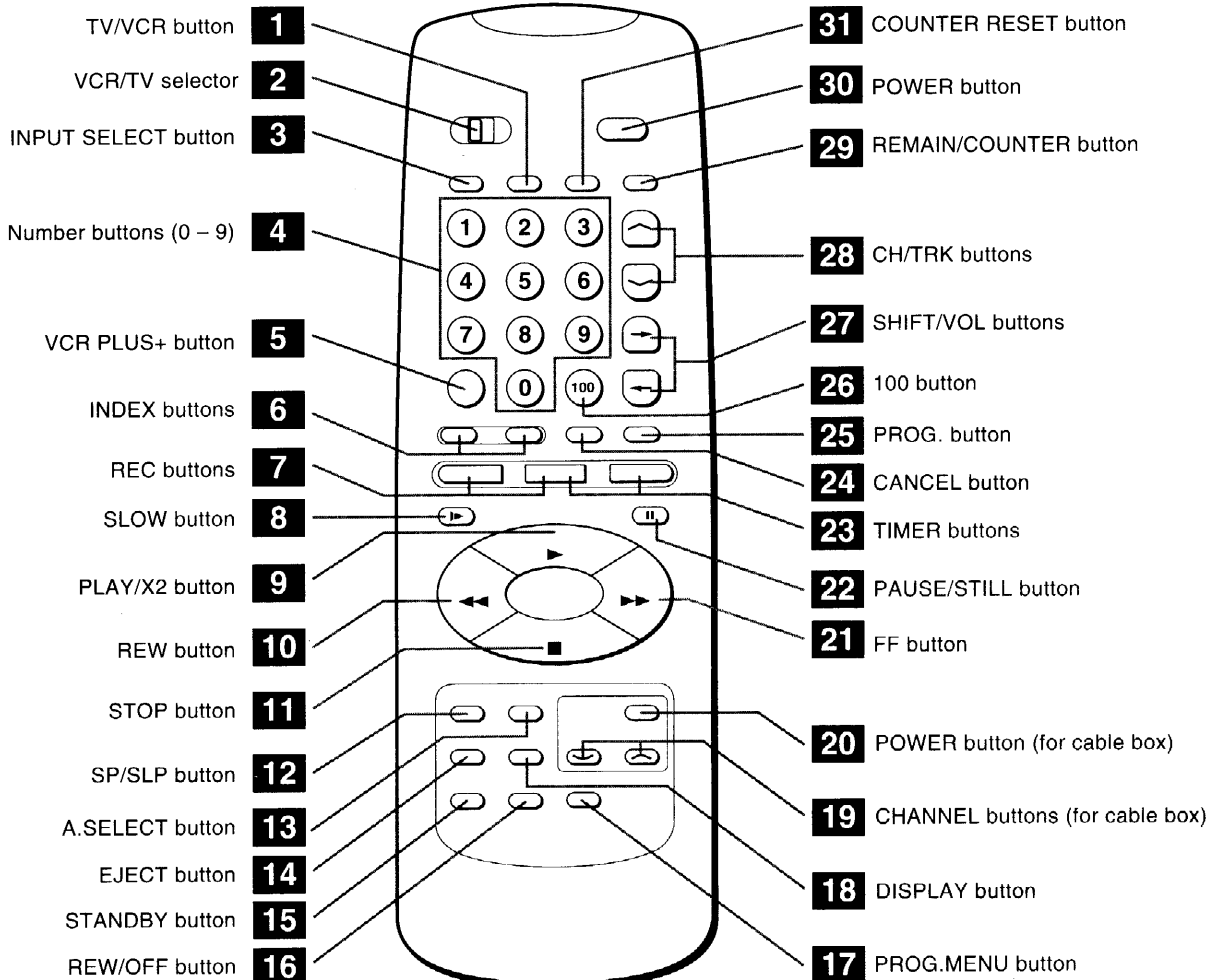

- A** POWER button
- B** EJECT button
- C** Cassette compartment
- D** PLAY button
- E** STOP button
- F** FF button
- G** REW button
- H** CHANNEL buttons
- I** VCR display
- J** Remote sensor
- K** REC button
- L** LINE IN 2 AUDIO jacks (L/MONO, R)
- M** LINE IN 2 VIDEO jack

**LINE IN 1 AUDIO (Rear), 2 (Front) jacks**

If the connected equipment is monaural (has one audio output jack), connect the L(MONO) side, the same sound is recorded on both L and R on the Hi-Fi track.

**Rear Panel**

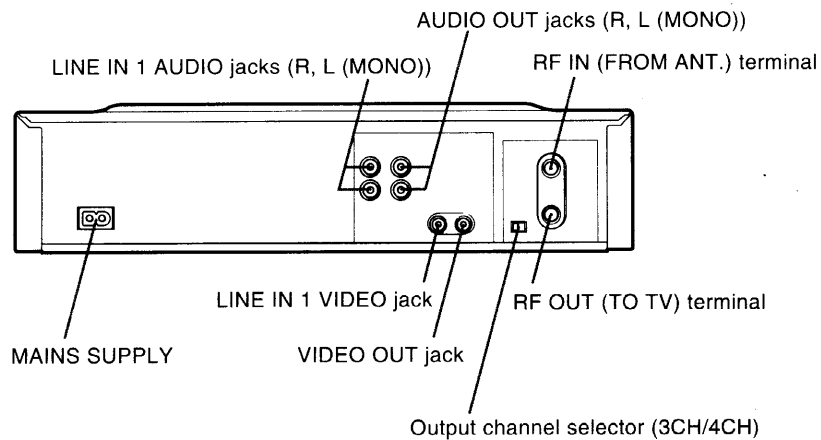

**VCR Display**

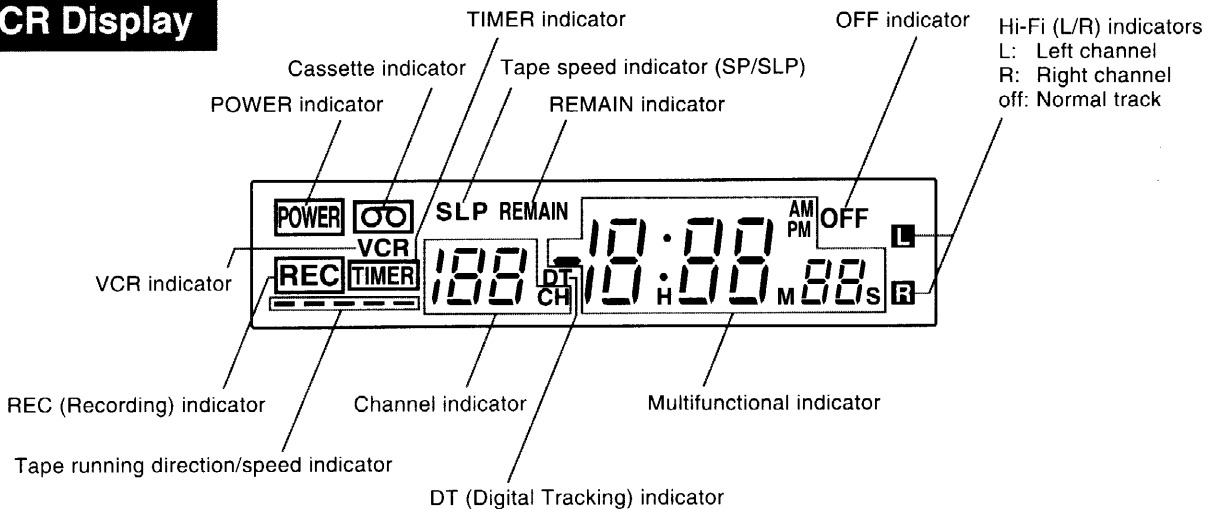



This section explains how to get ready for remote control operation.

## Setting up the Remote Control

- 1** Open the battery compartment lid on the rear panel.

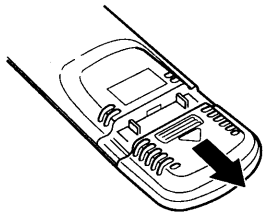

- 2** Install 2 batteries ("AAA" size) following the polarity diagrams.

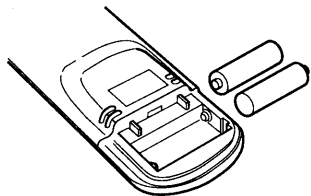

- 3** Close the battery compartment lid.

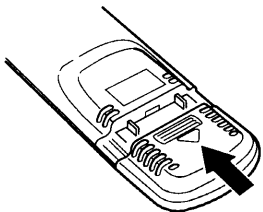

- 4** Point the remote control at the VCR and press the buttons within the operating range as illustrated.

Distance: within about 7 m from the front of the remote sensor

Angles: within about 30° in every direction

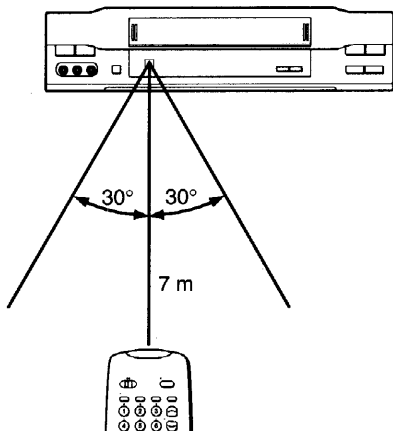

## Caring for Batteries

- The life of the batteries is about 1 year depending on the conditions of use.
- If the remote control does not operate correctly, replace all batteries with new ones.
- Do not dispose of the batteries by fire.
- If the remote control is not to be used for a long period of time, remove the batteries to avoid possible damage from battery corrosion.

## Caring for the Remote Control

- When using the remote control, press the buttons at intervals of about 1 second to ensure the correct mode of operation.
- Keep the remote control away from extremely hot or humid places and avoid sharp impacts.
- Do not expose the remote sensor of the VCR to a strong light source such as direct sunlight or illumination.
- Be careful not to spill water on the remote control or to place it on anything wet.

# 2

# CONNECTIONS

Before you use this VCR, it is necessary to connect it to your TV. Several ways of connecting are available depending on your use of TV or cable box. Select one which is applicable to your equipment.

## Antenna/VCR/TV Connection

- 1 Disconnect the antenna cable from your TV and connect it to the **RF IN** terminal on the VCR.
- 2 Connect the **RF OUT** terminal to the TV.
- 3 Connect the supplied power code to the AC socket (**MAINS SUPPLY**) of the VCR.

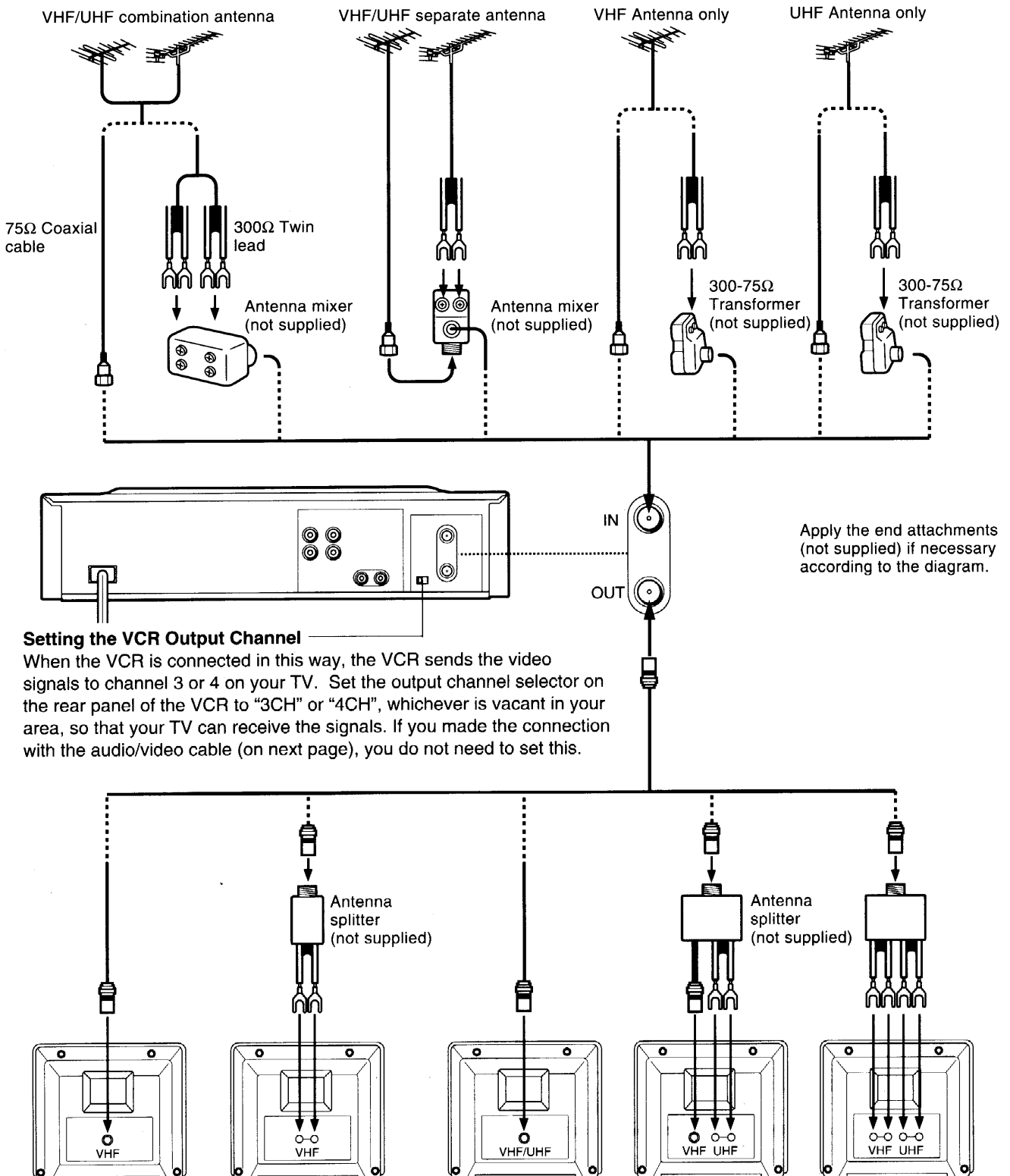

## Cable Connection

■ Choose one of the below according to your usage of the cable box.

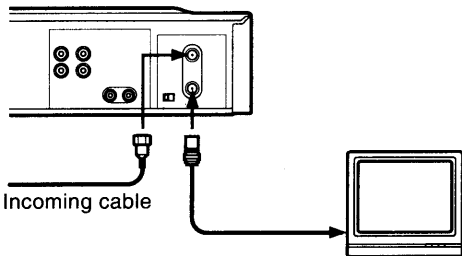

**This set-up will enable you to:**

- record an unscrambled channel.
- watch an unscrambled channel while recording it.
- record an unscrambled channel while watching another (only when you connect a cable-compatible TV).

**You will need to:**

- select TV channel 3 or 4 to receive video signals. (See page 9.)
- to record a channel while watching another, press the TV/VCR button on the remote control to turn off the "VCR" indicator in the VCR display and select a desired channel on the TV (only when you connect a cable-compatible TV).

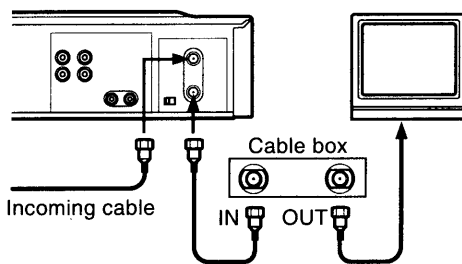

**This set-up will enable you to:**

- record an unscrambled channel.
- watch an unscrambled channel while recording it.
- record an unscrambled channel while watching another (scrambled or unscrambled).

**You will need to:**

- set TV channel to the output channel of the cable box.
- turn on the cable box and select cable channel 3 or 4 according to the output channel of the VCR.
- to record a channel while watching another, press the TV/VCR button on the remote control to turn off the "VCR" indicator in the VCR display and select a desired cable channel on the cable box.

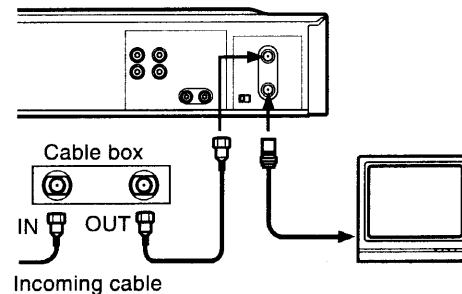

**This set-up will enable you to:**

- watch an unscrambled or scrambled channel while recording it.
- record any channels through the cable box.

**You will need to:**

- set TV channel 3 or 4 to receive video signals. (See page 9.)
- set VCR channel to the output channel of the cable box, and select a desired cable channel on the cable box.
- while the VCR is turned off or the "VCR" indicator is not lit in the VCR display, set TV channel to the output channel of the cable box.

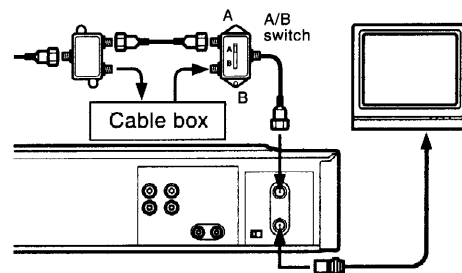

**This set-up will enable you to:**

- watch an unscrambled or scrambled channel while recording it.
- record an unscrambled channel while watching another unscrambled channel (only when you connect a cable-compatible TV).
- A/B switch "A": record and watch an unscrambled channel which comes bypassing the cable box.
- A/B switch "B": record and watch a scrambled or unscrambled channel coming through the cable box.

## AUDIO/VIDEO Connections

The AUDIO/VIDEO jacks are also available to connect your TV or cable box.

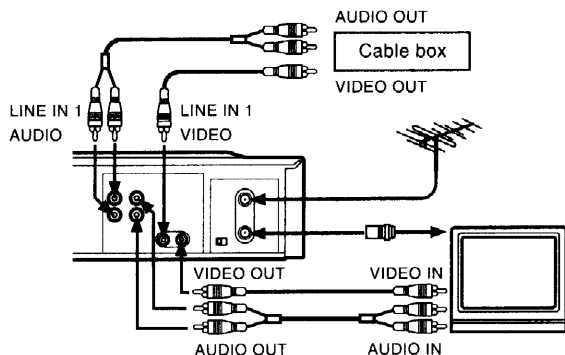

**Connecting your cable box using the LINE IN 1 (AUDIO/VIDEO) jacks**

To watch or record a channel via the connected cable box, press the INPUT SELECT button so that the VCR display shows "L1". For details, see page 30.

**Connecting your TV using the AUDIO/VIDEO OUT jacks**

It is not necessary to set the output channel selector (3CH/4CH) on the VCR and TV channel 3 or 4. To watch video pictures, set the video input mode on your TV. For the video input mode, refer to the manual of your TV.

The remote control can be compatible with various brands of TV by setting their control codes. The TOSHIBA code has initially been set to control TOSHIBA TVs.

## Setting Control Codes

### Preparation

Set the VCR/TV selector to "TV".



- 1** While holding down the **PROG.** button, enter the two digits of your TV's brand code (listed right) using **number buttons**.

Hold down.



example

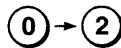

- 2** Release the **PROG.** button.
- 3** Point the remote control at your TV and use each button listed below to make sure that your TV is operated correctly.

POWER	To turn the TV on or off.	<b>30</b>
CH/TRK	To select TV channels in the upper or lower direction.	<b>28</b>
SHIFT/VOL	To adjust the sound level.	<b>27</b>
INPUT SELECT	To select an external source such as a VCR.	<b>3</b>
Number buttons	To select TV channels. When selecting channels 1 to 9, first enter 0 and then the desired number.	<b>4</b>
100	To substitute for ENTER or 100 channel key.	<b>26</b>
DISPLAY	To turn on or off TV's screen display.	<b>18</b>

### Important

Some TVs may not respond to all the operations above, or may not be operated at all with this remote control. In this case, operate your TV with its own remote control.

### Notes

- For some brands, several control codes (brand codes) are allocated. Try each of them until the buttons work on your TV.
- If you replace the remote control's batteries, set the brand code again.

Brand name of your TV	Brand code	Brand name of your TV	Brand code
Toshiba	01, 09, 12	Nikko	21
Admiral	08	Onwa	29
Akai	21	Optonica	08, 13
Anam	29	Orion	31
Anam National	23	Panasonic	07, 10, 15, 23
AOC	18, 21	Penney	01, 02, 12, 17 18, 19, 21, 22 24
Audiovox	29	Philco	10, 18, 21
Bell & Howell	09	Philips	10
Candle	21, 30	Portland	18, 22
Carver	10	Proton	11
Citizen	12, 21, 22, 30 32	Pulsar	14
Concerto	30	Quasar	07, 15, 23
Contec	29	Radio Shack	13, 29
Cralg	29	RCA	02, 17, 18, 24
Crown	22, 29	Realistic	09
Curtis Mathes	12, 21, 22	Runco (NEC)	14, 21
CXC	29	Sampo	21
Daewoo	18, 22	Samsung	12, 18, 21, 22 30
Daytron	22	Sanyo	09, 26
Emerson	11, 22, 28, 29 31, 32	Scott	28, 29, 33
Envision	21	Sears	01, 02, 09, 10 11, 26, 28, 30
Fisher	09, 26	Sharp	08, 13, 22
Fortress	08	Sony	03
Fujitsu	28	Soundesign	11, 29
Funai	28, 29	SSS	18, 29
Futuretech	29	Starlite	29
GE	02, 07, 11, 19 20, 23	Sylvania	10, 21
Goldstar	11, 18, 21, 22 30	Symphonic	27
Hallmark	11	Tandy	08, 22
Hitachi	06, 25, 30	Tatung	23
Infinity	10	Technics	07, 15
JBL	10	Techwood	30
JVC	05	Teknika	04, 12, 18, 22 28, 29, 30
Kenwood	21	TMK	11, 30
KTV	22, 29, 32	Totevision	22
Luxman	30	Universal	19, 20
LXI	01, 02, 09, 10	Vector Research	21
Magnavox	10, 21	Victor	05, 15
Marantz	10, 21	Vidtech	11, 18
Matsushita	15	Wards	10, 11, 13, 18 19, 20, 21, 28 30
Memorex	09, 11	Yamaha	18, 21
MGA	04, 11, 18, 21	Zenith	14
Mitsubishi	04, 11, 18		
MTC	12, 18, 21, 30		
NAD	01		
NEC	18, 21, 30		

# INITIAL SETTINGS USING ON-SCREEN DISPLAY

The VCR needs to be made the language selection and clock setting when first plugged in or encountered a power failure.

## Setting the Language

### Preparation

- Turn on the TV, and select the video channel (3 or 4), or the video input mode if you made the Audio/Video connection (page 10).
- Set the VCR/TV selector to "VCR".

**1** Press the **POWER** button to turn on the VCR. 30



**2** Press the **PROG.** button. 25  
The following screen appears on the TV.

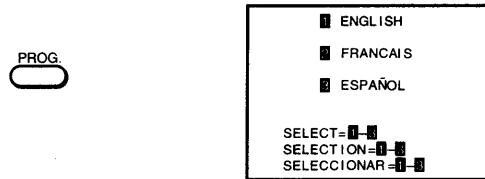

**3** Press **number button 1, 2 or 3** to select a language. 4  
The screen turns to the MENU screen.

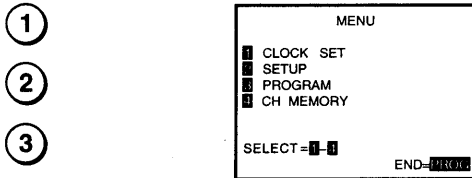

Press the **PROG.** button to return to the normal TV screen. 25

## Setting the Clock

The item to be set blinks. You can change the position by pressing the SHIFT buttons. 27

**Example** To set the clock to 2:30 p.m. on August 25 (summer time) 1995.

**1** Press the **PROG.** button. 25  
The MENU screen appears on the TV.



**2** Press **number button 1** to select "CLOCK SET". 4

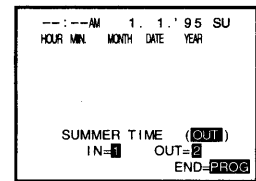

**3** To set it for summer (daylight saving) time, press **number button 1**: if not set, press **number button 2**. 4

**4** Set the hour and minutes. 4

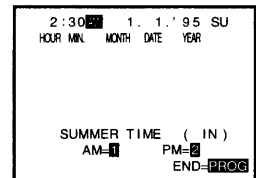
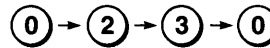

**5** Set "AM" or "PM" to "PM" by **number button 2**. 4

**6** Set the month and day. 4

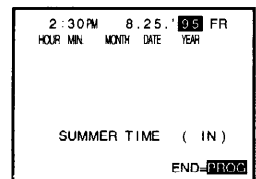
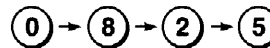

**7** Set the year with its last two digits. 4

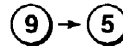

**8** Press the **PROG.** button. 25  
Now the clock starts.

**9** Press the **PROG.** button again to exit. 25

Other optional settings can be made. Press **number button 2** while the MENU screen is displayed. The screen turns to the SETUP screen. For details on each item, refer to pages respectively as below. 4

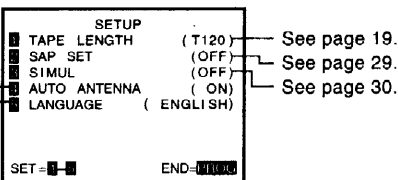

To change the language, press **number button 5** repeatedly until the desired language appears. 4

With "ON" set, a TV broadcast will appear via the TV tuner after playback. Press **number button 4** to switch "ON" or "OFF". 4

If you made the Audio/Video connection, set to "OFF".

To exit, press the **PROG.** button twice. 25

This section is required if you receive only normal TV or unscrambled cable channels, or use a cable box between your TV and the VCR.

## Automatic TV/CATV Channel Scanning

The VCR scans through all receivable TV and CATV channels and stores only the active ones in your area into the memory. Once the storing is finished, you can select a desired channel by using the CH/TRK buttons. 28

### Preparation

- Turn on the TV, and select the video channel (3 or 4), or the video input mode if you made the Audio/Video connection (page 10). 2
- Set the VCR/TV selector to "VCR". 3
- Turn on the VCR.
- Press the INPUT SELECT button so that the channel number will appear if "L1" or "L2" is displayed in the VCR display.

### Automatic TV Channel Scanning

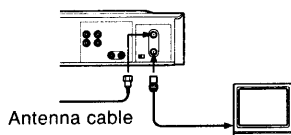

- 1** Press the **PROG.** button to display the MENU screen. 25

- 2** Press **number button 4** to select "CH MEMORY". 4

④

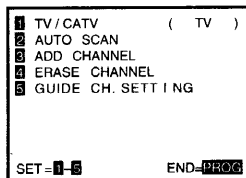

- 3** Make sure that "TV/CATV" shows "TV". If it does not, press **number button 1** to set to "TV". 4

①

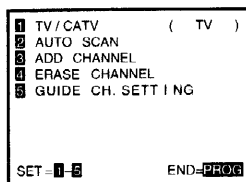

- 4** Press **number button 2** to select "AUTO SCAN". 4

②

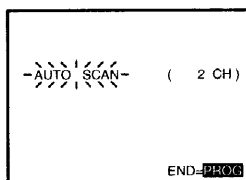

The VCR starts scanning and the channels are stored in the VCR in ascending order. When the scanning is finished, the screen automatically returns.

- 5** Press the **PROG.** button to exit. 25

### Automatic CATV Channel Scanning

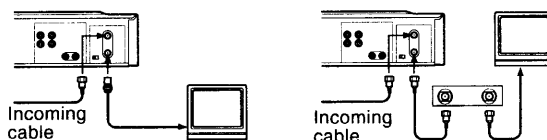

- 1** Press the **PROG.** button to display the MENU screen. 25

- 2** Press **number button 4** to select "CH MEMORY". 4

④

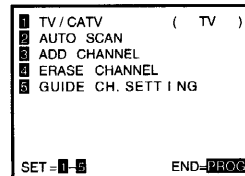

- 3** Press **number button 1** to set "TV/CATV" to "CATV". 4

①

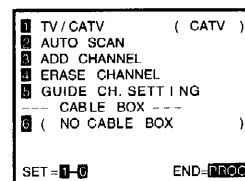

- 4** Press **number button 6** to select "NO CABLE BOX". 4

⑥

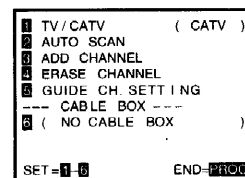

**5** Press **number button 2** to select "AUTO SCAN".

**4**

**2**

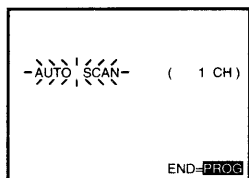

The VCR starts scanning and the channels are stored in the VCR in ascending order. When the scanning is finished, the screen automatically returns.

**6** Press the **PROG.** button to exit.

**25**

### Selecting Stored Channels

Once the active channels have been stored, you can select the channels in two ways below.

**Number buttons:** to enter digits of the channel number

- For one-digit number, enter 0 before.
- For more than 100 number, first press the **100** button.
- Each number button needs to be pressed within 2 seconds.

**4**

**26**

**CH/TRK** buttons: to shift up or down the stored channel numbers

**28**

### Adding or Erasing Channels

#### Adding channels

If a desired channel cannot be scanned automatically because of a weak signal, it can be added to the memory.

#### Erasing channels

You can erase a stored channel from the memory if it is unnecessary.

1) Follow steps 1 to 3 of "Automatic TV Channel Scanning" or "Automatic CATV Channel Scanning".

2) Select "ADD CHANNEL" or "ERASE CHANNEL" by **number button 3** or **4**.

**4**

**3** To add channels

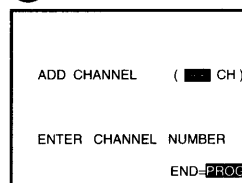

**4** To erase channels

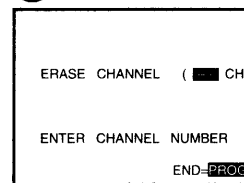

3) Enter a channel number of 1 to 125 by using **number buttons**.

**4**

For more than 100 number, first press the **100** button.

**26**

For CATV channels, refer to the chart below. (For other orders, check with your cable company.)

4) Repeat steps 2) and 3) above to add or erase channels as necessary.

5) Press the **PROG.** button to exit.

**25**

### Channel Reference Chart

Number on the VCR		1	2	3	4	5	6	7	8	9	10	11	12	13	14	15	16	17	18										
Corresponding channel number		TV	CATV STD (HRC/IRC)																										
			1(A-8)	2	3	4	5(A-7)	6(A-6)	7	8	9	10	11	12	13	A	B	C	D	E									
19	20	21	22	23	24	25	26	27	28	29	30	31	32	33	34	35	36	37	38	39	40	41	42	43	44	45	46	47	48
F	G	H	I	J	K	L	M	N	O	P	Q	R	S	T	U	V	W	AA	BB	CC	DD	EE	FF	GG	HH	II	JJ	KK	LL
49	50	51	52	53	54	55	56	57	58	59	60	61	62	63	64	65	66	67	68	69	70	71	...	93	94	95	96	97	98
MM	NN	OO	PP	QQ	RR	SS	TT	UU	VV	WW	XX	YY	ZZ	AAA	BBB	65	66	67	68	69	70	71	...	93	94	A-5	A-4	A-3	A-2
99	100	101	102	103	...	121	122	123	124	125																			
A-1	100	101	102	103	...	121	122	123	124	125																			

#### CATV signals

- STD (standard) cable TV signals
- HRC (Harmonic Related Carriers) cable TV signals
- IRC (Incremental Related Carriers) cable TV signals  
IRC is also called ICC (Incremental Coherent Carriers)

## INTEL-A-PLAY Function

This function lets you make a set of basic operations on both the VCR and the TV by simply pressing a button.

### Setting up the function

#### Preparation

- See "MULTI BRAND REMOTE CONTROL" on page 11 and make your TV compatible with this VCR.
- Locate the VCR and a TV as close as possible so both units can receive the infrared signals from the remote control.

- 1 Press the **STANDBY** button firmly several times until "READY" appears on the TV screen. Do not press it over and over again quickly, or this function may not work. 15

STANDBY

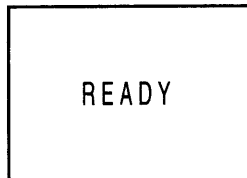

- 2 Press the **STANDBY** button to select TV channel 3, 4 or the video input mode. Each time you press the button, the screen changes as follows. 15

3ch → 4ch → Video input mode (ex. VIDEO IN 1)



The setting is finished and the function is now available.

By pressing a button, the VCR and TV work as below.

STANDBY 	TV: Turns on. Selects the video channel (3 or 4) or video input mode as you have set. VCR: Turns on.	15
REW/OFF 	TV: Turns off. VCR: Rewinds the tape to the beginning and then turns off.	16
PROGMENU 	TV: Turns on. VCR: Turns on and displays a screen for VCR Plus+ programming.	17

#### Notes

- Do not press the STANDBY button while "READY" is on the TV screen, or the memory of the input source is canceled. If that happens, repeat the setting again.
- If your TV has more than one external input, connect the VCR to the first input jack (ex. VIDEO IN 1, LINE IN 1, E1, and etc.) of the TV, or the INTEL-A-PLAY function won't work even though it is compatible with the VCR.
- Depending on the TV you use, this function may not be compatible with your set. Due to different manufacturing sources from TV brands, INTEL-A-PLAY might not work even though the manual shows compatibility with your brand.
- This function is not available when the VCR is in the recording mode.

## Video Cassette Use

### Loading a Cassette

Push the cassette into the cassette compartment with the window side facing up and the label side towards the front. The VCR is automatically turned on. The  indicator will appear in the VCR display. C

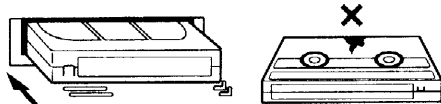

### Ejecting a Cassette

Press the **EJECT** button. The cassette is ejected from the cassette compartment. B 14

#### Warning

Do not insert your hands or any foreign objects into the compartment. This may result in injury or damage. Take special care with children to avoid accidents.

Video cassettes have a safety tab to prevent accidental erasure. If the tab has already removed, recording cannot be performed.

### To prevent accidental erasure

Remove this safety tab with a screwdriver.

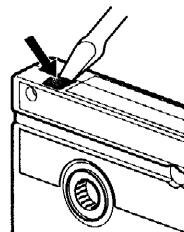

### To record again

Cover the tab hole with adhesive tape.

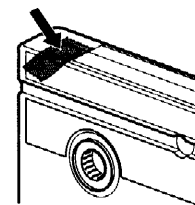

- Avoid exposing cassettes to direct sunlight. Keep them away from heaters. Avoid extreme humidity, vibrations or shock, strong magnetic fields (near a motor, transformer or magnet) and dusty place.



This section explains the basic playback operation.

## Basic Playback

### Preparation

- Select the video channel (3 or 4) or video input mode on the TV.
- Set the VCR/TV selector to "VCR".

2

- 1** Load a recorded cassette. Power is turned on. If the cassette has no safety tab, playback starts automatically. C

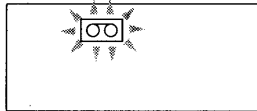
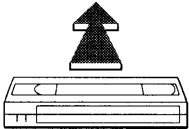

- 2** Press the **PLAY/X2** button to start playback. 9 D

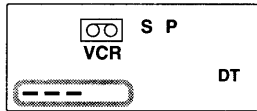

- 3** To stop playback, press the **STOP** button. 11 E

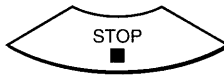

- To rewind, press the **REW** button in the stop mode. 10 G

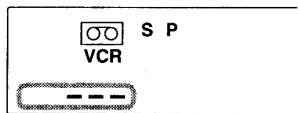

- To fast-forward, press the **FF** button in the stop mode. 21 F

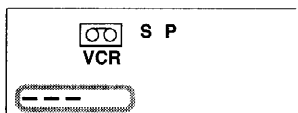
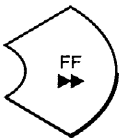

## Adjusting the Tracking

### ■ Digital Auto Tracking

When playback starts, the VCR automatically adjusts the tracking for clear pictures and sound. The "DT" indicator blinks during the adjusting.

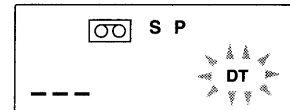

#### Notes

- During the adjusting, the playback picture and sound may be distorted.
- The digital auto tracking is activated only in the playback mode.

### ■ Adjusting the tracking manually

If the VCR cannot locate the best possible tracking point, hold down one of the **CH/TRK** button until you obtain the best possible picture and sound. 28



#### Notes

- To reset the tracking point to the center, press both the CHANNEL buttons on the VCR simultaneously for no longer than 1 second. H
- To resume the digital auto tracking, hold down both the CHANNEL buttons on the VCR simultaneously for about 2 seconds. H
- The noise on the screen may not be completely eliminated depending on the tape used, especially when the tape was recorded on another VCR.



- If the recorded tape does not have a video signal, Digital Auto Tracking may not be working correctly. To enjoy HiFi sound, use Manual Tracking.



You can play back a tape at various tape speeds.

## Picture Search



You can locate a particular scene while viewing a playback picture in the fast-forwarding or rewinding mode.



- 1 During playback, press the **REW** or **FF** button. The tape runs at 5 times the normal playback speed. 10  
21

Playback   to reverse picture search (5 times)

Playback   to forward picture search (5 times)

- 2 If you continue to press and hold the **REW** or **FF** button, the search speed increases. 10  
21

Reverse picture search (5 times)   **Hold down.** to reverse picture search (9 times)

Forward picture search (5 times)   **Hold down.** to forward picture search (9 times)

When you release the button, the speed returns to 5 times.

- 3 To resume normal playback, press the **PLAY/X2** button. 9  
D

### Notes

- The picture will have some interference. This is not a defect in the unit.
  - If you play back a tape recorded in the SLP tape speed or a tape recorded on another VCR in various speed mode, the picture may be noisy or monochrome.
  - If you press the **REW** or **FF** button while rewinding or fast-forwarding the tape, the VCR enters the picture search mode. 10  
21
- If you press the **REW** or **FF** button while picture searching, the VCR enters the rewinding or fast-forwarding mode, respectively. 10  
21

## Double Speed Playback

- 1 Press the **PLAY/X2** button during playback. The picture runs at twice the normal speed. 9  
D



- 2 To resume normal playback, press the **PLAY/X2** button. 9  
D

## Still Picture

You can freeze a picture to watch closer.

- 1 During playback, press the **PAUSE/STILL** button. The picture freezes. 22

Playback   to still picture

- 2 To resume playback, press the **PAUSE/STILL** button again. 22

Still picture   to normal playback

The still mode is automatically canceled after about 5 minutes and returns to normal playback.

### Notes

- The still picture may shake if a picture of a fast-moving object or scene is frozen. This is not a defect in the unit.
- If you play back a tape recorded in the SLP tape speed or recorded on another VCR in various speed mode, the picture may be noisy or monochrome.
- If noises appears in the still picture, adjust the tracking manually in the slow-motion mode. (See next page.)

## Adjusting Still Picture Stability

- If the still picture is distorted or flickers, hold down one of the **CH/TRK** button until the picture becomes stable. 28



### Note

The distortion of the still picture may not be eliminated completely.

## Frame Advance

You can advance the picture frame by frame.

- 1 During playback, press the **PAUSE/STILL** button. 22



- 2 Press the **PLAY/X2** button. Each time you press the button, the picture advances one frame. 9  
D

While the button is held down, the tape runs at 1/30th the normal playback speed.

- 3 To resume normal playback, press the **PAUSE/STILL** button. 22

## Slow-motion Picture

You can playback at 1/7th or 1/15th the normal playback speed.

- 1 During playback, press the **SLOW** button. The tape will run at about 1/7th the normal playback speed. 8



- 2 If you press the **SLOW** button again, the speed changes to 1/15 slow. Each time you press the button, the speed changes between 1/7 and 1/15. 8

- 3 To resume normal playback, press the **PLAY/X2** button. 9



The slow-motion picture mode will be canceled automatically after approximately 5 minutes to shift to the normal playback mode.

### Note

The slow-motion picture may flicker up and down. This is not a defect in the unit.

### Note

The picture search and accelerated picture search speeds differ depending on the recording tape speed of the tape.

Picture search: SP: 5 times, SLP: 15 times  
Accelerated Picture search: SP: 9 times, SLP: 27 times

## Adjusting the Tracking Manually

If the slow-motion picture is noisy, hold down one of the **CH/TRK** button until the best picture is obtained. 28



### Note

The noise in the slow-motion picture may not be eliminated completely by the tracking adjustment.

These functions will help your playback.

## Counter Function

You can view the clock, linear time counter or tape remaining time in the VCR display or on the TV screen.

### Preparation

Set the VCR/TV selector to "VCR". 2

Each time you press the **REMAIN/COUNTER** button, the VCR display changes in sequence as follows: 29

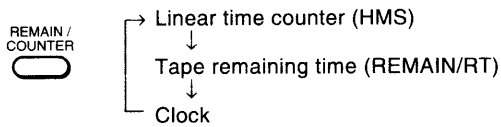

The indication above will also appear on the TV screen by pressing the **DISPLAY** button. They are switchable with the **REMAIN/COUNTER** button. 18  
29

### To reset the linear time counter to "0H00M00S"

The counter is automatically reset to "0H00M00S" when a cassette is ejected. If you want to reset at another point, such as the beginning of a new recording, just press the **COUNTER RESET** button. 31

### Notes

- The linear time counter does not work on non-recorded portions on the tape.
- When the tape is ejected or the VCR is turned off, the display changes to clock.
- If the tape rewinds back over "0H00M00S", "—" appears in the VCR display.
- The displayed time of the linear time counter is only an approximation.

## Tape Remaining Time

**1** Turn on the VCR and load a cassette. C

**2** Press the **PROG.** button to display the MENU screen. 25

**3** Press **number button 2** to select "SETUP". 4

**4** Press **number button 1** to select the tape length to be used. 4

- 1**
- T120: for a T-120 tape or shorter
  - T160: for a T-140 or T-160 tape
  - T180: for a T-180 tape

**5** Press the **PROG.** button twice to exit. 25

**6** Press the **REMAIN/COUNTER** button. The "REMAIN" indicator appears in the VCR display, and "RT" is displayed on the TV screen with the tape remaining time. 29

### Notes

- The displayed remaining time is an approximation.
- The remaining time is calculated according to the tape speed (SP or SLP) and the cassette type.

## Index Search Function

The VCR can find a point where a registered index signal is on a tape and play back for about 5 seconds. You can easily locate the desired program by inputting the index signal.

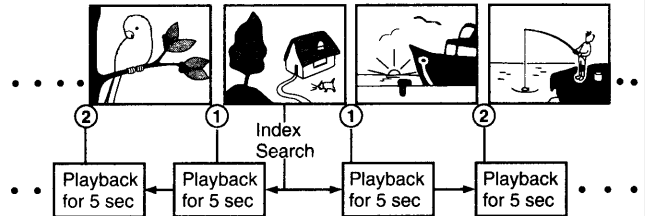

## Registering Index Signals

Each time a recording starts, an index signal is automatically registered.

To register it somewhere else, press the **INDEX** button during recording. 6

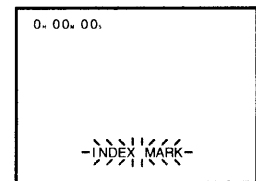

### Notes

- An index signal is not registered when the recording is resumed from the pause mode.
- A certain interval is required between the index signals: more than 1 minute in the SP tape speed and more than 3 minutes in the SLP tape speed.

## Index Search

**1** Load a cassette with the index signals registered. C

**2** Press the **INDEX** button in the stop or playback mode. 6

: to search in the reverse direction.

: to search in the fast-forward direction.

The VCR fast-forwards or rewinds the tape. When an index signal is found, the VCR plays back the tape for about 5 seconds, and then resumes fast-forwarding or rewinding. This is repeated each time at an index signal.

**3** Press the **PLAY/X2** button when the desired program is found. Normal playback starts. 9  
D

### Notes

- At the very beginning of the tape, the index search may not work properly.
- If you registered the index signals on a tape recorded on another VCR, the recording may be blurred at the index point and the index search may not work properly.

This section explains the basic recording operation.

## Basic Recording

### Preparation

- Turn on the VCR.
- Select the video channel (3 or 4) or video input mode on the TV.
- Set the VCR/TV selector to "VCR".
- If you record cable channels via the cable box, finish the cable box set-up (pages 27 and 28), and turn on the cable box.

**1** Load a cassette with the safety tab attached. C

**2** Press the **TV/VCR** button so that the "VCR" indicator appears in the VCR display. 1

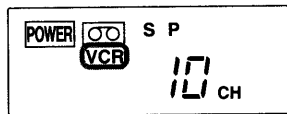

**3** Select a channel to record with the **CHANNEL** buttons on the VCR, or the **CH/TRK** buttons or **number buttons** on the remote control. H 28

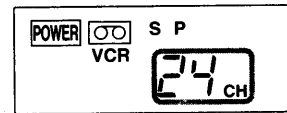

If you see "L1" or "L2" in the VCR display, press the **INPUT SELECT** button so that the channel number appears. 3

- If you record cable channels via the cable box, make the output channel number of the cable box or "L1" appear, depending on your connection. (See page 10.)

**4** Press the **SP/SLP** button to select the recording tape speed. 12

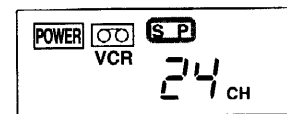

**SP:** Suitable for general recording with better picture and sound quality.

**SLP:** Suitable for tripling recording time, but with less picture and sound quality than using the SP mode.

**5** Press the **REC** button on the VCR, or simultaneously press the two **REC** buttons on the remote control. Recording starts. K 7

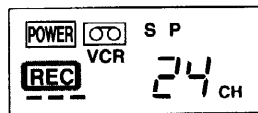

**6** Press the **STOP** button to stop recording. 11 E

**1)** While recording, press the **TV/VCR** button so that the "VCR" indicator disappears in the VCR display. 1

**2)** Choose another channel using the channel selector on the TV.

### Note

To monitor the program which is being recorded, press the **TV/VCR** button so that the "VCR" indicator will appear in the VCR display. Select the video channel or video input mode on the TV. 1

Press the **PAUSE/STILL** button to stop recording momentarily. To resume recording, press the **PAUSE/STILL** button again. 22

### Note

The VCR automatically shifts to the stop mode if the recording pause mode continues for 10 minutes.

While recording, you can set the off time. K

Press the **REC** button on the VCR to set the off time. Each time you press the button, it changes the VCR display as follows:

Example

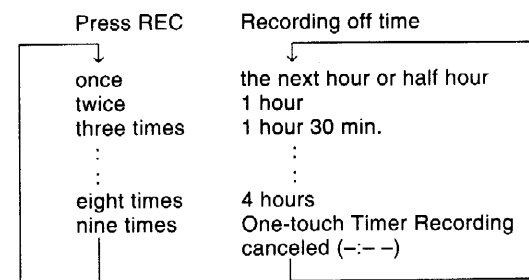
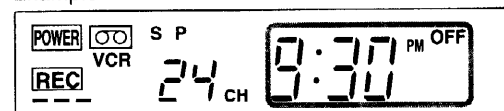

By setting the recording off time, the recording stops and the VCR is turned off automatically.

### Notes

- To cancel the one-touch timer recording in progress, press the **STOP** button. E
- To delay the recording off time, further press the **REC** button on the VCR. K
- If the VCR clock is not set, the one-touch timer recording will not activate.

The programmable timer allows you to record up to 6 different programs over one month.

## Timer Programming Procedure

### Preparation

- Turn on the VCR.
- Select the video channel (3 or 4) or video input mode on the TV.
- Make sure that the clock is set correctly. (See page 12.)
- Select TV or CATV mode. (See pages 13 and 14.)
- Set the VCR/TV selector to "VCR".
- If you record cable channels, finish the cable box set-up (pages 27 and 28), and turn on the cable box.

2

### Example

to record cable channel 25 in the SP tape speed from 9:30 p.m. until 10:00 p.m. on August 30. Today is August 25.

1 Load a cassette with the safety tab attached. C

2 Press the **PROG.** button. 25

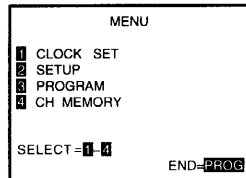

3 Press number button 3. 4

3

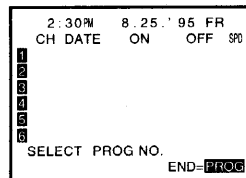

4 Select program number 1. 4

1

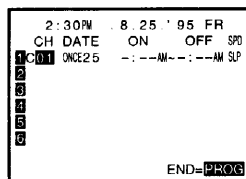

5 To select cable channel 25, make sure that the "C" for cable channel is displayed, and press number button 2 and 5. 4

2 → 5

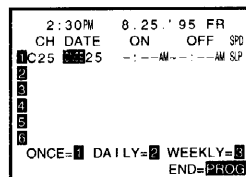

If [USE:NO REMOTE] has been selected on page 27, enter the output channel number of the cable box with number buttons or make "L1" appear by pressing the **INPUT SELECT** button, depending on your connection. (See page 10.) Then select the channel on the cable box. 4

3

### To make corrections:

Press the SHIFT (←) button to move back to the item, or the SHIFT (→) button to forward. 27

6 Select a one-time recording. 4

1

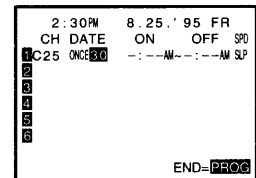

You can also set daily or weekly timer program recordings. See next page.

7 Set the recording date. 4

3 → 0

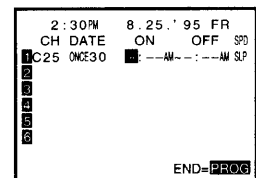

8 Set the hours and minutes and a.m. or p.m. of the recording start time. 4

0 → 9 → 3 → 0

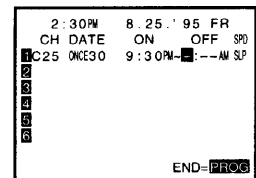

9 Set the hours and minutes and a.m. or p.m. of recording off time. 4

1 → 0 → 0 → 0

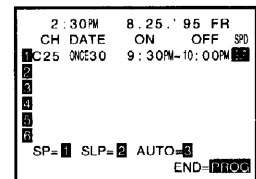

10 Select the tape speed (SP). 4

1

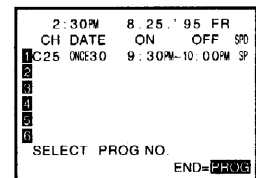

For the tape speed "AUTO (Auto Speed Select)", see next page.

To set another program, follow steps 4 to 10. In step 4, select next program number.

- 11** Press the **PROG.** button.  
Now programming is complete. **25**

PROG.

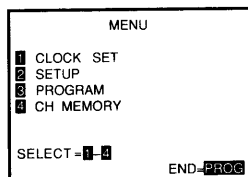

- 12** Press the two **TIMER** buttons simultaneously. **23**



The power turns off and the VCR enters the timer standby mode.

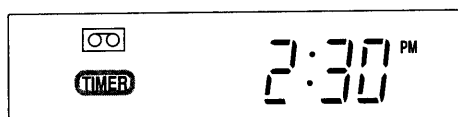

### Confirming the Timer Programs (In the Timer Standby Mode)

Press the **PROG.** button.  
The screen for confirming will appear. **25**

PROG.

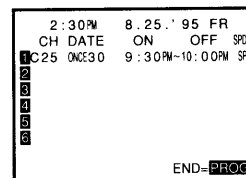

After about 30 seconds, the screen disappears.

### Changing/Canceling the Timer Programs

- 1) If the **TIMER** indicator is lit, press the two **TIMER** buttons to turn it off, and then turn the VCR on by pressing the **POWER** button. **23**  
**30**
- 2) With steps 2 to 11, change the items. **24**
  - To cancel a program, select the program number you want to cancel in step 4, and press the **CANCEL** button. The line is then cleared.
- 3) Press the two **TIMER** buttons to return to the timer standby mode. **23**

### Recording or Playback in the Timer Standby Mode

- First press the two **TIMER** buttons to release the timer standby mode, and then press the **POWER** button to turn on the VCR. The VCR will be available for use. **23**  
**30**
- Be sure to press the two **TIMER** buttons again to return the VCR to the timer standby mode after you are finished. **23**

### Daily and Weekly Recording

#### Daily recording:

You can record TV programs on the same channel at the same time Monday through Friday. Press **number button 2** for "DAILY" in step 6. **4**

#### Weekly recording:

You can record TV programs on the same channel on the same day and time every week. Press **number button 3** for "WEEKLY", then **number button 1** to 7 to select a day of the week in step 6. **4**

### Auto Speed Select

If you are not sure the tape is long enough for timer program recording in the SP tape speed, set the recording tape speed to "AUTO".

Recording starts in the SP tape speed and the VCR automatically selects the tape speed to record the program to the end. If the tape length is not long enough, the tape speed automatically changes from SP to SLP.

#### Notes

- Make sure that the tape length is selected correctly according to the tape used on the SETUP screen. (See page 19.)
- When the SLP tape speed is selected and the tape length is not sufficient to record the program to the end, the program cannot be recorded to the end.
- The picture will be distorted when playing the part where the recording tape speed is switched from SP to SLP with the Auto Speed Select feature.

#### Error Indication

- The "E" (Error) indicator appears in the VCR display if you press the **TIMER** buttons when:
  - a cassette is not loaded.
  - the loaded cassette has no safety tab.
  - no timer program is set.
 In these cases, a recording can not be made.

#### If a power failure occurs during the timer program recording

- When a power failure has occurred, "12:00AM" blinks in the VCR display. Since the programmed contents have been cleared, reset the clock and timer programming.
- When power has failed for a short time, the colon of the current time display blinks. The programmed contents are not affected. Reset the clock.

#### Overlaps of the programs

If two timer programs overlap, the recording start time of program 2 has priority over the recording off time of program 1.

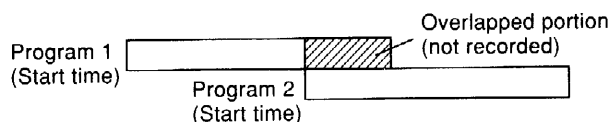

RECORDING

# 4 VCR Plus+ SET-UP

VCR Plus+ is a timer recording system for an easier programming that requires you only to enter a PlusCode assigned to a desired program. This section explains the necessary set-up to make VCR Plus+ recordings.

The flow chart below will give you an idea as to what must be done to use the VCR Plus+ feature.

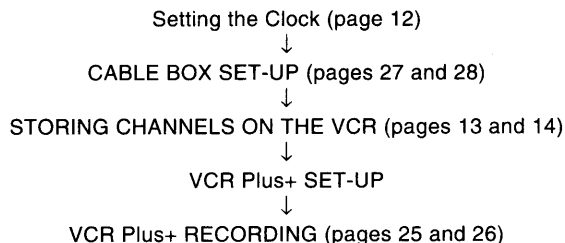

\* VCR Plus+ and PlusCode are trademarks of Gemstar Development Corp. VCR Plus+ system is manufactured under license from Gemstar Development Corporation.

You must give the VCR the special numbers for guide channels (also called VCR Plus+ channel numbers) assigned to each channel that you receive in your home. The VCR identifies the channel to be recorded by the guide channel number you enter. The guide channel numbers are published in TV guide magazine, selected local TV publications, or the channel guide from cable company. If you cannot find the numbers, call Gemstar's customer service department at 1-800-4321-VCR.

Sample of a Guide channel chart from a local TV listing

Broadcast channels	Assigned channels	Cable channels	Assigned channels
3 KCRA (NBC)	.....3	A & E	.....39
6 KVIE (PBS)	.....6	AMC	.....35
10 KXTV (CBS)	.....10	BET	.....57
13 KOVR (ABC)	.....13	BRAV	.....54
19 KCSO (SPAN)	.....19	CMTV	.....14
31 KRIBK (IND)	.....31	CNBC	.....23
40 KTLX (FOX)	.....40	CNN	.....42
58 KSCH (IND)	.....25	C-SPAN	.....28
44 KBHK (IND)	.....15	CUNY	.....29
24 KCPM (NBC)	.....24	DIS	.....53
4 KRNK (NBC)	.....28	ESPN	.....34
42 KFCB (IND)	.....27	FAM	.....47
7 KGO (ABC)	.....28	HBO	.....33

The set-up procedure for guide channel numbers varies depending on the connection of the VCR. First, check the type of your connection.

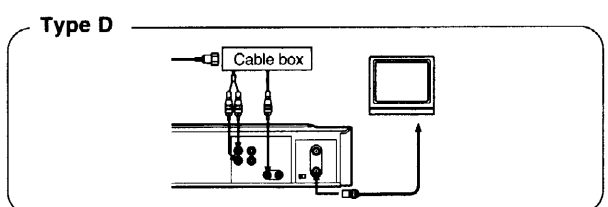
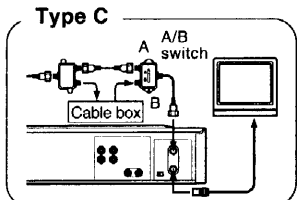
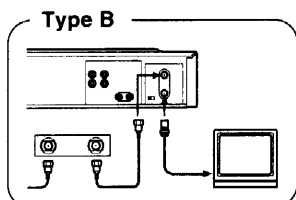
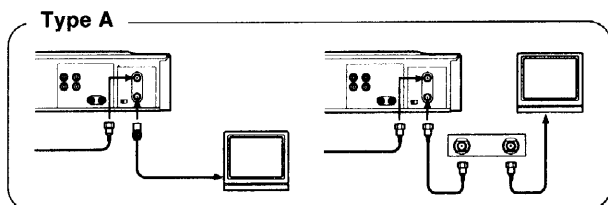

## Guide Channel Setting

### Preparation

- Turn on the VCR.
- Select the video channel (3 or 4) or video input mode on the TV.
- Set the VCR/TV selector to "VCR".
- If you record cable channels, finish the cable box set-up (pages 27 and 28).
- Prepare the list like below. (If you use a NON remote-controllable cable box with the connection of **Type B** or **Type D**, no need to do this.)

### Example

Station	Guide channel number (on the TV Guide, local TV listings etc.)	Your home channel number (on the channel line-up chart supplied by cable companies)
HBO	33	7
ESPN	34	
AMC	35	

- 1 Press the **PROG.** button to display the MENU screen.
- 2 Press **number button 4** to select "CH MEMORY".
- 3 Press **number button 1** to select "TV" or "CATV".

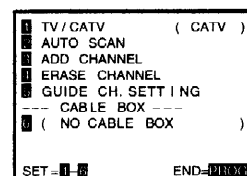
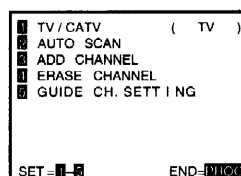



- 4** Press **number button 5**.  
The guide channel list for TV or CATV appears on the screen.

**4**

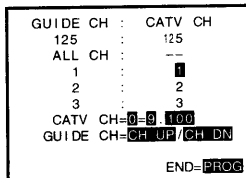

(the case of CATV mode)

- 5** Enter channel numbers on the right of the guide channel numbers.  
Use procedure I, II or III as below.

Connection	Is your cable box remote controllable or not (pages 27 and 28)	Follow procedure
<b>Type A</b>	—	I
<b>Type B</b>	Yes	I
	No	II
<b>Type C</b>	Yes	I
	No	III
<b>Type D</b>	Yes	I
	No	II

- I** Press the **CH/TRK** button to find a guide number you marked on the list, and enter the corresponding home channel number if necessary by using **number buttons**.

**28**

**4**

Example: to enter home channel number 7 (HBO) with guide channel number 33 assigned.

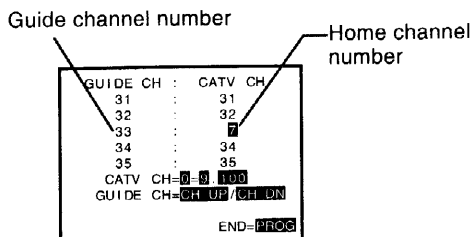

After having entered all home channel numbers, proceed to step 6.

**Note**

In some areas, one channel may be assigned more than one guide channel number. In this case, enter the home channel number to each of the guide channel numbers.

- II** Press the **CH/TRK** button to select "ALL CH", and then enter, if your connection is . . .

**28**

**Type B, C:** the output channel number of your cable box using **number buttons**. (Usually 3 or 4. Check the rear of the cable box.)

**4**

**Type D:** the line input mode "L1" using the **INPUT SELECT** button.

**3**

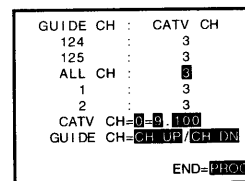

example

**3**

The right column will change all at once.

- To make a correction, select "ALL CH" and press the **CANCEL** button.

**24**

Proceed to step 6.

- III** As your home channels have two ways to come in, two procedures are required: one for channels via your cable box, the other for channels bypassing the cable box with the A/B switch.

First follow procedure II above, and then follow I for channels you watch with A/B switch set to "A".

Example: if HBO is viewed with A/B switch set to "A".

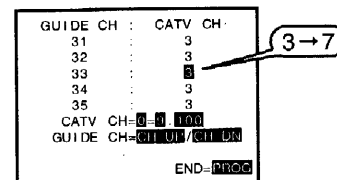

- 6** Press the **PROG.** button three times to exit. The set-up is all over and your VCR Plus+ recording is now available.

**25**

**Notes**

- Once you complete the VCR Plus+ set-up, you do not have to repeat it even after power failure.
- When your cable company changes the channel line-up, you must re-do this set-up for the channel.

RECORDING

After performing the VCR Plus+ set-up, you can easily program a recording simply by entering the PlusCode. The numbers are published in the TV listings of newspapers, TV guide magazine, etc.

## VCR Plus+ Programming

### Preparation

- Make sure that the clock is set correctly. (See page 12.)
- Set the VCR/TV selector to "VCR".
- Load a cassette with a safety tab.

**2**  
**C**

### For cable box users:

- Finish the cable box set-up (pages 27 and 28), and turn on the cable box.
- If your cable box is not remote-controllable, select the recording channel on the cable box beforehand.

### Sample of TV program listing in a TV guide magazine

5PM **FAM POPEYE**—Cartoon 725692  
**HBO MAKING OF A CHAMPION** 237945  
 A look at gymnast and Olympic hopeful Kim Zmeskal from novice to seasoned competitor.  
**NIK HEY DUDE**—Children (793571) ← PlusCode  
 One of Ted's teachers stays at the ranch.  
**USA MY TWO DADS**—Comedy (586858)  
 5:35 **TBS GOOD TIMES**—Comedy 2261858

**1** Press the **VCR PLUS+** button  
 The PLUSCODE screen appears. **5**

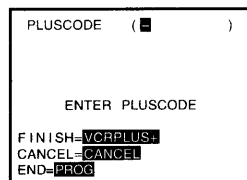

**2** Enter a PlusCode. **4**  
**Example:** to record a program with the PlusCode number 32479 (fictitious code).

Press **number button 3, 2, 4, 7 and 9**.  
 Confirm that the number is entered correctly.

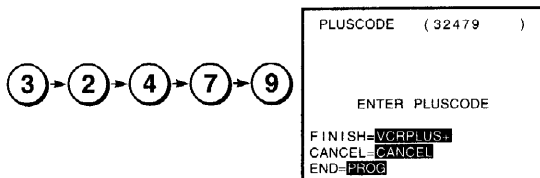

To correct a mistake, press the **CANCEL** button **24** and enter the correct number.

**3** Press the **VCR PLUS+** button  
 The screen changes as follows. **5**

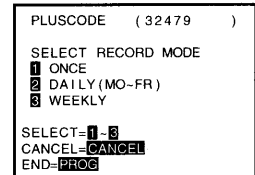

- ONCE:** to record once.
- DAILY(MO~FR):** to record programs on the same channel at the same time Monday through Friday.
- WEEKLY:** to record programs on the same channel at the same time on the same day every week.

**4** To select "ONCE" for example, press **number button 1**. (Or **number button 2** for "DAILY (MO~FR)", **number button 3** for "WEEKLY".) **4**  
 The programming has been made automatically.

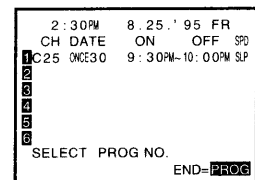

**5** To select the recording tape speed, press the **SP/SLP** button. **12**



For **AUTO** speed, see page 22.

**6** Press the **VCR PLUS+** button. **5**  
 The program setting is now memorized.



**7** To set another program, repeat steps 2 to 6.

**8** To finish press the two **TIMER** buttons simultaneously. **23**  
 The VCR enters the timer standby mode.

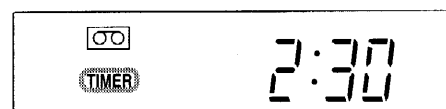

## Confirming the VCR Plus+ Timer Programs

### ■ Before the VCR enters the timer standby mode (TIMER indicator not lit)

- 1) Press the **PROG.** button to display the MENU screen. **25**
- 2) Press **number button 3** to select "PROGRAM". **4**

3

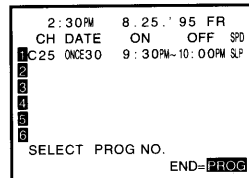

Check the programmed data.

- 3) Press the **PROG.** button twice to exit. **25**

### ■ During the timer standby mode (TIMER indicator lit)

Press the **PROG.** button. **25**  
The screen for confirming appears.

PROG.

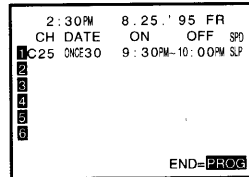

After about 30 seconds, the screen disappears.

## Canceling the VCR Plus+ Timer Programs

- 1) If the **TIMER** indicator is lit, press the two **TIMER** buttons to turn it off, and turn on the VCR by pressing the **POWER** button. **23**  
**30**
- 2) Press the **PROG.** button to display the MENU screen. **25**
- 3) Press **number button 3** to select "PROGRAM". **4**
- 4) Select a program number which you want to cancel by using **number buttons**. **4**
- 5) Press the **CANCEL** button. **24**  
The line is cleared out.
- 6) Press the **PROG.** button. **25**

## Recording or Playback in the Timer Standby Mode

First press the two **TIMER** buttons to release the timer standby mode, and then press the **POWER** button to turn on the VCR. The VCR will be available for use. **23**  
**30**

- Be sure to press the two **TIMER** buttons again to return the VCR to the timer standby mode after you are finished. **23**

### If a power failure occurs during the timer program recording

- When a power failure has occurred, "12:00AM" blinks in the VCR display. Since the programmed contents has been cleared, reset the clock and timer programming.
- When power has failed for a short time, the colon of the current time display blinks. The programmed contents are not affected. Reset the clock.

### Error indications

If "FULL CANCEL PROG.?" message appears on the TV during programming, no more programs can be entered. If you want to add another, delete one existing program on the screen by using number button. **4**

If an incorrect PlusCode number is entered, "INVALID CODE" blinks on the screen. Press the **CANCEL** button to clear the number and enter correct one. **24**

If "CLASH" message appears on the TV during programming, it tells you that two programs with the same recording start time have been entered. Correct either of the two programs as follows:

- 1) Enter the number of the program to correct by using number buttons. **4**
- 2) Correct the data, or clear out the line by pressing the **CANCEL** button and then press the **VCR PLUS+** button to enter a PlusCode number. **24**  
**5**

### Overlaps of the programs

If two timer programs overlap, the recording start time of program 2 has priority over the recording off time of program 1.

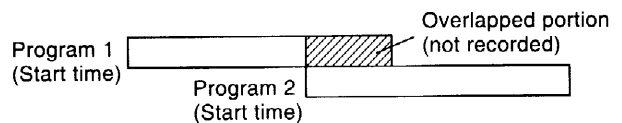

RECORDING

The VCR can directly control channel selecting of the connected cable box.

## Cable Box Control

This VCR needs to be connected to a cable box equipped with an infrared wireless remote control. You can select cable channels from the cable box by operating this VCR.

It is also possible to automatically change the cable channels according to your program setting in the timer program recording or VCR Plus+ recording.

### Placing the Cable Box

Put the cable box on the top of the VCR as shown below. Do not block the sensor window.

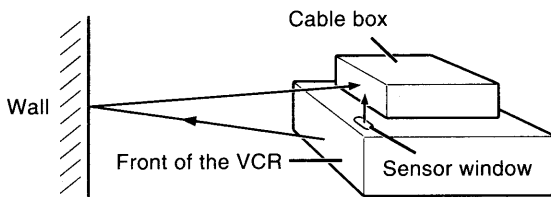

The infrared signals come out of the sensor window and the front of the VCR. Then they bounce off walls and other objects in the room and are received by the cable box. The VCR sends out infrared signals to your cable box even during timer program recording or VCR Plus+ recording.

### Notes

- If the channels cannot be controlled properly because the infrared signal fails to reach the cable box, change the position of the box on the VCR so that it can receive the signal.
- Keep the cable box turned on even while the VCR is in the timer program recording or VCR Plus+ recording.
- Do not connect the VCR's AC power cord to a cable box's AC outlet, or the VCR may not work. In result, the VCR remote control won't work on the cable box.

### Connection Type

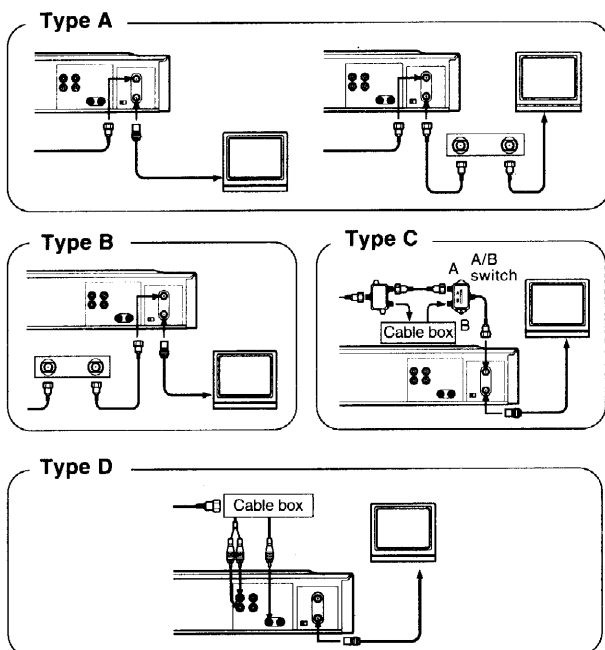

## Cable Box Set-up

### Preparation

- Select the video channel (3 or 4) or video input mode on the TV.
- Set the VCR/TV selector to "VCR".

**1** Press the **PROG.** button to display the MENU screen. **25**

**2** Press **number button 4** to select "CH MEMORY". **4**

**3** Set "TV/CATV" to "CATV" by pressing **number button 1**. **4**

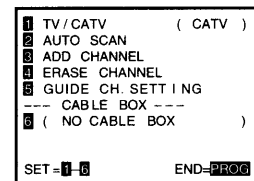

**4** Press **number button 6** to select [NO CABLE BOX], [USE:WITH REMOTE] or [USE:NO REMOTE] according to your connection type. **4**

- Type A
- Type C (A/B switch "A")

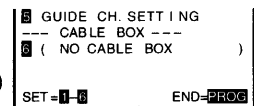

Go to step 7.

Cable channels will be selected by the CH/TRK buttons on the remote control or the CHANNEL buttons on the VCR. **28**

- Type B
- Type C (A/B switch "B")
- Type D with remote-controllable cable box

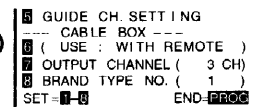

Go to step 5.

Cable channels will be selected by the CHANNEL (CABLE BOX) buttons on the remote control. The VCR can change the cable channel to the desired one when timer recording and VCR Plus+ recording starts. **19**

- Type B
- Type C (A/B switch "B")
- Type D with NON remote-controllable cable box

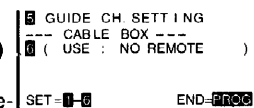

Go to step 7.

Cable channels will be selected by the own channel selector of the cable box. The VCR channel should be set to the output channel of the cable box.

- 5** Press **number button 7**, and set "OUTPUT CHANNEL" depending on your connection. **4**
- Type B, C:** the output channel number of your cable box using **number buttons**. (Usually 3 or 4. Check the rear of the cable box.) **4**
- Type D:** the line input mode "L1" using the **INPUT SELECT** button. **3**

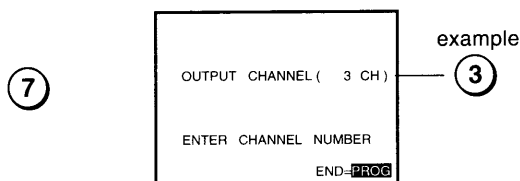

The screen will return.

- 6** Press **number button 8**, and enter a brand code of your cable box using **number buttons**. Refer to the table on the right. **4**

Example: For a TOSHIBA cable box, identified by number 36.

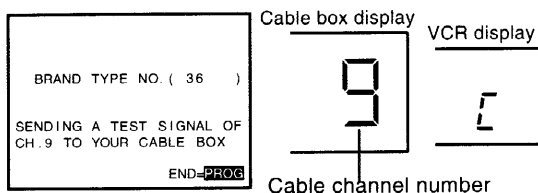

Make sure that the channel display of your cable box has changed to 9. If not, try each brand code assigned to the brand of your cable box until the display changes to 9. If it still holds;

- Relocate the cable box on the VCR.
- Use each of digits from 1 to 91.

- 7** Press the **PROG.** button to exit. **25**

**Note**  
If your cable channel does not change to 9 in step 6, the cable box will not be able to change channels in the timer recording. In this case, set [USE:NO REMOTE] in step 4.

### Buttons to Control a Remote-Controllable Cable Box

Once you complete the set-up for a remote controllable cable box, your cable box can be controlled by the following buttons on the remote control of the VCR.

- **POWER (CABLE BOX) button** **20**  
to turn the cable box on or off.
- **CHANNEL (CABLE BOX) buttons** **19**  
to select cable channels in the upper or lower direction. (not applicable to some brands of cable box.)
- **Number buttons (0 - 9)** **4**  
to select desired channels to record.
- **100 button** **26**  
Some cable boxes require you to use this button as the enter button. Press this button after selecting the cable channel with number buttons.

### Table of Cable Box Brand Codes

Brand name of your cable box	Brand code
TOSHIBA	36
ANVISION	13, 20, 21, 22, 23, 24, 25, 26, 58, 62, 84
ARCHER	1, 20, 21, 29, 42, 44, 63, 88, 91
CABLESTAR	13, 20, 21, 22, 23, 24, 25, 26, 58, 62, 84
CABLEVIEW	30, 42, 44, 52, 63, 88
CITIZEN	30, 42, 44, 52, 63, 88
CURTIS	8, 9, 56, 61
DIAMOND	1, 20, 21, 29, 42, 44, 63, 88, 91
EAGLE	13, 20, 21, 22, 23, 24, 25, 26, 58, 62, 84
EASTERN	26, 28
GC BRAND	30, 42, 44, 52, 63, 88
GEMINI	4, 30, 85
GENERAL INSTRUMENT	1, 2, 3, 4, 31, 34, 55, 85, 91
HAMLIN	14, 15, 28, 41
HITACHI	31, 79, 80
JERROLD	1, 2, 3, 4, 31, 34, 55, 85, 91
MACOM	31, 79, 80
MAGNAVOX	13, 20, 21, 22, 23, 24, 25, 26, 58, 62, 84
MOVIE TIME	29, 32, 38, 39, 42, 44, 88
NSC	29, 32, 38, 39, 42, 44, 88
OAK	10, 11, 12, 13, 46
OAK SIGMA	10, 11, 12, 13, 46
PANASONIC	6, 8, 16, 17
PHILIPS	4, 13, 20, 21, 22, 23, 24, 25, 26, 58, 62, 84
PIONEER	5, 6, 78
PULSAR	30, 42, 44, 52, 63, 88
RANDTEK	13, 20, 21, 22, 23, 24, 25, 26, 58, 62, 84
RCA	6, 8, 16, 17
REALISTIC	44, 88
REGAL	14, 23, 41, 84
REGENCY	26, 28
REMBRANDT	29, 32, 38, 39, 42, 44, 88
SAMSUNG	4, 6, 32, 42, 78
SCIENTIFIC ATLANTA	8, 9, 56, 61
SHERITECH	27
SL MARK	4, 6, 32, 42, 78
SPRUCER	6, 8, 16, 17
STARGATE	4, 6, 30, 32, 42, 44, 52, 63, 78, 88
SYLVANIA	19
TEKNIKA	74
TELECAPTION	77
TELEVIEW	4, 6, 32, 42, 78
TEXSCAN	18, 19
TOCOM	1, 33, 34, 42, 48, 49, 73, 91
UNIKA	1, 20, 21, 29, 42, 44, 63, 88, 91
UNIVERSAL	29, 42, 43, 44, 52, 63, 82, 88
VIDEOWAY	7, 23, 45, 50, 84
VIEWSTAR	13, 20, 21, 22, 23, 24, 25, 26, 58, 62, 84
WARNER AMEX	6
ZENITH	7, 23, 45, 50, 84

# 4

## MTS BROADCAST COMPATIBILITY

This VCR can receive or record MTS (Multichannel TV Sound) broadcasts. By connecting the VCR to your stereo system or stereo TV, you will experience the SAP or stereo sound.

### Recording the SAP/Stereo Broadcast

- Make sure that the VCR is connected to a mono TV and stereo system with speakers, or a stereo TV.

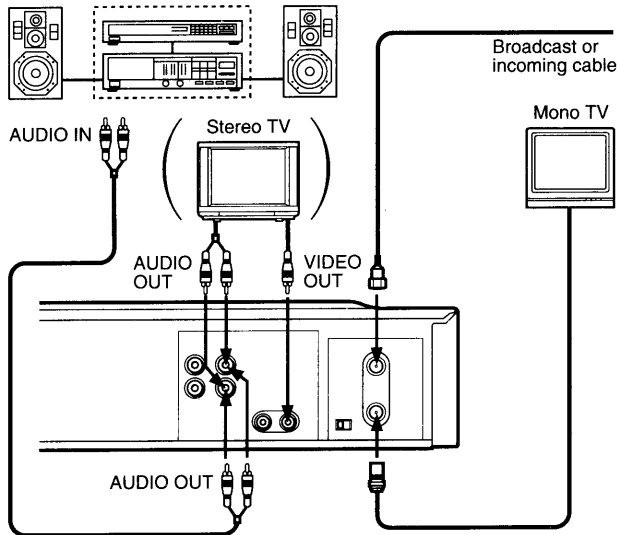

**SAP (Second Audio Program broadcast):**  
A separate audio program, usually broadcast in a second language with the main language.

#### Preparation

Set the VCR/TV selector to "VCR".

2

- Press the **PROG.** button to display the MENU screen. 25
- Press **number button 2** to display the SETUP screen. 4
- Press **number button 2** to set "SAP SET" to "ON". 4

SETUP	
1	TAPE LENGTH ( T120 )
2	SAP SET ( ON )
3	SIMUL ( OFF )
4	AUTO ANTENNA ( ON )
5	LANGUAGE ( ENGLISH )
SET = 1-5      END=PROG	

2

Each time you press the button, "ON" or "OFF" appears alternately.

- Press the **PROG.** button twice to exit. 25
- Perform a recording.

### Selecting a Sound

- Sounds recorded on the tape  
According to your setting of "SAP SET" on the SETUP screen, the sound is recorded onto different tracks of the tape as below. Set "SAP SET" to "ON" or "OFF" appropriately.

Type of receiving broadcast	Setting of "SAP SET" on the SETUP screen	On-Screen Display (Press the <b>DISPLAY</b> button.)		Contents of recorded sound		
		"SAP"	"STEREO"	Normal sound track (Mono)	Hi-Fi sound track	
					L	R
Regular (monaural audio)	"ON" or "OFF"	not lit	not lit	MONO	MONO	MONO
Stereo	"ON" or "OFF"	not lit	lit	MONO (MIXED)	STEREO	
Regular+SAP	"ON"	lit	not lit	MONO	MONO	SAP
	"OFF"	lit	not lit	MONO	MONO	MONO
Stereo+SAP	"ON"	lit	lit	MONO	MONO	SAP
	"OFF"	lit	lit	MONO (MIXED)	STEREO	

18

- Sounds in playback  
You can play SAP and/or stereo broadcasts with this VCR. Press the **A.SELECT** button to select a desired sound.

13

Desired sound	L R indicators in the VCR display	Sound output
SAP sound	R(right) is on.	SAP
Stereo sound	Both R (right) and L (left) are on.	Stereo

#### Note

When the TV is connected to the RF OUT terminal of the VCR, the output sound is monaural.

**LIMITED WARRANTY**  
**TOSHIBA VIDEO CASSETTE RECORDER**

Toshiba America Consumer Products, Inc. ("TACP") and Toshiba Hawaii Inc. ("THI") make the following limited warranties. These limited warranties extend to the original consumer purchaser or any person receiving this set as a gift from the original consumer purchaser and to no other purchaser or transferee.

**Limited Ninety (90) Day Warranty**

TACP and THI warrant this product against defects in materials or workmanship for a period of ninety (90) days after the date of original retail purchase. During this period, TACP and THI will repair a defective product or part, without charge to you. You must deliver the entire product to a TACP/THI Service Center. You pay for all transportation and insurance charges for the set to and from the Service Center.

**Limited One (1) Year Warranty**

TACP and THI further warrant the parts in this product against defects in materials or workmanship for a period of one year after the date of original retail purchase. During this period, TACP and THI will replace a defective part without charge to you, except that if a defective part is replaced after ninety (90) days from the date of the original retail purchase, you pay labor charges involved in the replacement. You must also deliver the entire product to one of the TACP/THI Service Centers. You pay for all transportation and insurance charges for the set to and from the Service Center.

**Owner's Manual and Registration Card**

You should read the owner's manual thoroughly before operating this product. You should also insure that your name and address are on file as owners of a TACP/THI product by completing and mailing the enclosed registration card within ten days after you, or the person who has given you this product as a gift, purchased this product. This is one way to enable

TACP/THI to establish the date of purchase of the product, as well as to provide you with better customer service and improved products. Failure to return the card will not affect your rights under this warranty so long as you retain other proof of purchase such as a bill of sale.

**Your Responsibility**

The above warranties are subject to the following conditions:

- (1) You must retain your bill of sale or provide other proof of purchase. Completing and mailing in the enclosed registration card within ten days after the original retail purchase is one way of providing such other proof of purchase.
- (2) You must notify an Authorized TACP/THI Service Station within thirty (30) days after you discover a defective product or part.
- (3) All warranty servicing of this product must be made by an Authorized TACP/THI Service Station.
- (4) These warranties are effective only if the product is purchased and operated in the U.S.A..
- (5) Labor service charges for set installation, set up, adjustment of customer controls and installation of repair or antenna systems are not covered by this warranty. Reception problems caused by inadequate antenna systems are your responsibility.
- (6) Warranties extend only to defects in materials or workmanship as limited above and do not extend to any product or parts which have been lost or discarded by you or to damage to products or parts caused by misuse, accident, improper installation, improper maintenance or use in violation of instructions furnished by us; or to units which have been altered or modified without authorization of TACP/THI or to damage to products or parts thereof which have had the serial number removed, altered, defaced or rendered illegible.

**Step-By-Step Procedures ~ How To Obtain Warranty Service**

**IN THE CONTINENTAL  
UNITED STATES ...**

Should your unit require  
service or parts, CALL



**HAWAII**

Toshiba Hawaii Inc.  
Service Department  
327 Kamakee Street  
Honolulu, HI 96814  
Phone Number:  
(808) 521-5377

**IN THE EVENT A PROBLEM SHOULD DEVELOP WITH YOUR PRODUCT, PLEASE PROCEED AS FOLLOWS:**

- (1) Refer to the troubleshooting guide in your owner's manual. This check list may solve your problem.
- (2) Contact one of the TACP/THI Service Centers listed below for warranty service or call the TACP toll free number 1-800-631-3811 within thirty (30) days after you find a defective product or part.
- (3) Arrange for the delivery of the product to the Authorized TACP/THI Service Center. Products shipped to the Service Center must be insured and safely and securely packed, preferably in the original shipping carton, and a letter explaining the defect and also a copy of the bill of sale or other proof of purchase must be enclosed. All transportation and insurance charges must be prepaid by you. (See PROCEDURE.)
- (4) If you have any question about service, please contact one of the following TACP/THI Service Centers:

**EAST**

82 Totowa Road  
Wayne, NJ 07470  
Phone Number:  
(201) 628-8000

**SOUTHEAST**

490 Armour Circle,  
N.E.  
Atlanta, GA 30324  
Phone Number:  
(404) 872-6955

**MIDWEST**

1010 Johnson Drive  
Buffalo Grove, IL 60089  
Phone Number:  
(708) 541-9400

**SOUTHWEST**

1421 Champion Drive  
Suite 304  
Carrollton, TX 75006  
Phone Number:  
(214) 243-1367

**WEST**

5490 E. Francis  
Street, Ontario,  
CA 91761  
Phone Number:  
(909) 988-5303

**IMPORTANT: PACKING AND SHIPPING INSTRUCTIONS**

When you send the product to a service center, you must use the original carton box and packing material, then insert the original carton box containing the unit into another carton, using more packing material.

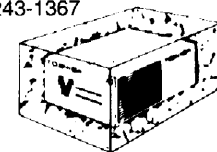

**ALL WARRANTIES IMPLIED BY STATE LAW, INCLUDING THE IMPLIED WARRANTIES OF MERCHANTABILITY AND FITNESS FOR A PARTICULAR PURPOSE, ARE EXPRESSLY LIMITED TO THE DURATION OF THE LIMITED WARRANTIES SET FORTH ABOVE.** Some states do not allow limitations on how long an implied warranty lasts, so that above limitation may not apply to you. **WITH THE EXCEPTION OF ANY WARRANTIES IMPLIED BY STATE LAW AS HEREBY LIMITED, THE FOREGOING EXPRESS WARRANTY IS EXCLUSIVE AND IN LIEU OF ALL OTHER WARRANTIES, GUARANTEES, AGREEMENTS AND SIMILAR OBLIGATIONS OF MANUFACTURER OR SELLER WITH RESPECT TO THE REPAIR OR REPLACEMENT OF ANY PRODUCT OR PARTS.**

**IN THE EVENT SHALL TACP OR THI BE LIABLE FOR CONSEQUENTIAL OR INCIDENTAL DAMAGES.** Some states do not allow the exclusion or limitation of incidental or consequential damages so the above limitation may not apply to you.

No person, agent, distributor, dealer, service station or company is authorized to change, modify or extend the terms of these warranties in any manner whatsoever. The time within which an action must be commenced to enforce any obligation of TACP and THI arising under this warranty or under any statute, or law of the United States or any state thereof, is hereby limited to one year from the date you discover or should have discovered, the defect. This limitation does not apply to implied warranties arising under state law. Some states do not permit limitation of the time within which you may bring an action beyond the limits provided state law so the above provision may not apply to you. This warranty gives you specific legal rights and may also have other rights which vary from state to state.

**TOSHIBA AMERICA CONSUMER PRODUCTS, INC.**

# 5

## BEFORE CALLING SERVICE PERSONNEL

Check the following symptoms before requesting servicing.

• No power.	• The power cord is not plugged in.	• Plug the power cord into the outlet firmly.	–
• Although the power is on, the VCR will not work.	• There is no cassette.	• Load a cassette.	15
• The clock does not work.	• There has been a power failure.	• Reset the clock.	12
• The timer does not work properly.	• The time is incorrect.	• Set the clock correctly.	12
• The picture does not appear on the TV screen.	• The video channel or video input mode is not set correctly.	• Set the TV channel to the video channel (3 or 4) or set the video input mode on the TV.	9, 10
	• The TV signal is weak.	• Adjust the antenna direction or use an optional antenna booster.	–
	• The power cord is not plugged in.	• Plug the power cord into the outlet firmly.	–
• The picture does not appear on the TV screen during recording and playback.	• The video channel or VCR mode is not set correctly.	• Press the TV/VCR button to select the VCR mode and set the TV channel to 3 or 4.	9, 20
• The VCR does not record.	• The loaded cassette has no safety tab.	• Use a cassette with a safety tab or cover the hole with adhesive tape.	15
• The playback picture is poor.	• Tracking is not set appropriately.	• Adjust the tracking manually.	16
	• The video heads are dirty.	• Clean the video heads with a commercially available cleaning tape.	–
• The desired sound is not heard, such as SAP, stereo, or regular sound.	• Setting of the A.SELECT button is not correct.	• Select a desired sound using the A.SELECT button.	29
• Noise is present in the Hi-Fi sound being played.	• Tracking is not set appropriately.	• Adjust the tracking manually.	16
• The timer recording function does not work.	• There is an error in programming.	• Reset the timer recording program.	21, 22
	• There is no cassette in the VCR.	• Load a cassette with the safety tab attached.	15
	• The cassette does not have the safety tab.	• Use another cassette with a safety tab or cover the hole with adhesive tape.	15
	• The timer indicator is not displayed.	• Press the two TIMER buttons simultaneously.	22
	• There has been a power failure.	• Reset the clock.	12
	• The cable box set-up has not been set correctly.	• Make the set-up correctly.	27, 28
	• The cable box is not turned on.	• Turn on the cable box.	–
• The VCR Plus+ recording cannot be done.	• The guide channel numbers are not set up correctly.	• Make the guide channel number setting.	23, 24
	• The cable box is not turned on when the channel comes in the VCR via the cable box.	• Turn on the cable box.	–
	• The cable box set-up has not been set correctly.	• Make the set-up correctly.	27, 28
	• The timer indicator is not displayed.	• Press the two TIMER buttons simultaneously.	25
• The remote control does not work properly.	• The batteries are exhausted.	• Replace all batteries.	8
	• The remote control is operated beyond the operating range.	• Make sure the remote control is within 30° of the remote sensor on the VCR.	8
	• Too far from the VCR.	• Use the remote control within 7 m from the front of the VCR.	8
	• An obstacle may be in the way of the operation.	• Remove the obstacle.	–
	• Setting of the VCR/TV selector is not correct.	• Check the VCR/TV selector setting.	11
• The cassette is ejected immediately after it is loaded.	• The cassette was inserted with the label side not paralleling the compartment.	• Reload it carefully.	15
• The cassette does not go into the cassette compartment.	• There is already a cassette in the VCR.	• Eject the cassette and reload the new one.	15