



DSL-500
ADSL Router
User's Guide

Second Edition (April 2001)

6DSL500...02

TABLE OF CONTENTS

ABOUT THIS USER'S GUIDE	IV
BEFORE YOU START.....	IV
<i>Operating Systems.....</i>	<i>iv</i>
<i>ADSL Service.....</i>	<i>iv</i>
INTRODUCTION	1
ROUTER DESCRIPTION AND OPERATION.....	1
ADSL TECHNOLOGY	1
PRODUCT FEATURES	2
<i>PPP (Point-to-Point Protocol) Security.....</i>	<i>2</i>
<i>DHCP Support (Dynamic Host Configuration Protocol).....</i>	<i>2</i>
<i>Network Address Translation (NAT).....</i>	<i>2</i>
<i>TCP/IP (Transfer Control Protocol/Internet Protocol).....</i>	<i>2</i>
<i>RIP-1/RIP-2.....</i>	<i>2</i>
<i>Static Routing.....</i>	<i>2</i>
<i>Default Routing.....</i>	<i>3</i>
<i>ATM (Asynchronous Transfer Mode).....</i>	<i>3</i>
<i>Precise ATM Traffic Shaping.....</i>	<i>3</i>
<i>G.hs (Auto-handshake).....</i>	<i>3</i>
<i>High Performance.....</i>	<i>3</i>
<i>Full Network Management.....</i>	<i>3</i>
<i>Telnet Connection.....</i>	<i>3</i>
<i>Easy Installation.....</i>	<i>3</i>
STANDARDS COMPATABILITY AND COMPLIANCE	4
UNPACKING.....	5
FRONT PANEL	5
REAR PANEL	5
LED INDICATORS.....	6
HARDWARE INSTALLATION	7
CONNECT THE POWER	7
CONNECT ADSL LINE	7
CONNECT ETHERNET LAN TO ROUTER	7
CONNECT SERVER OR PC TO ROUTER.....	9
WEB BASED ROUTER MANAGEMENT.....	10
INTRODUCTION.....	10
GETTING STARTED	10
SETTING UP THE PC.....	10
MANAGEMENT	12
<i>PPPoE Configuration.....</i>	<i>14</i>
<i>DHCP.....</i>	<i>15</i>
<i>NAT Configuration.....</i>	<i>17</i>
<i>Port Redirection.....</i>	<i>19</i>
<i>Advanced Filter/Firewall.....</i>	<i>20</i>
<i>Connection Type.....</i>	<i>24</i>
<i>Static IP Address Configuration.....</i>	<i>25</i>
<i>Line Condition.....</i>	<i>26</i>
<i>User Name and Password.....</i>	<i>27</i>
<i>Save Changes.....</i>	<i>28</i>
<i>Update Firmware.....</i>	<i>29</i>

<i>Summary</i>	30
SAVING CHANGES	31
FINDING THE PASSWORD.....	31
CONTACTING TECHNICAL SUPPORT.....	32
D-Link[®] OFFICES.....	32
TECHNICAL SPECIFICATIONS.....	35
IP CONCEPTS.....	37
IP ADDRESSES.....	37
SUBNET MASK	39
DSL-500 FIRMWARE UPGRADE UTILITY	40
LIMITED WARRANTY	43

About This User's Guide

This user's guide provides instructions on how to install the DSL-500 ADSL Router and use it to connect several PCs on an Ethernet LAN (Local Area Network) to the Internet or remote LAN. For the sake of simplicity, this document uses the terms Router (first letter upper case) to refer specifically to the DSL-500 ADSL Router, and router (first letter lower case) to refer to all such devices including the DSL-500.

This guide assumes that the reader is familiar with Ethernet networks, networking devices, routing protocols and the TCP/IP suite of protocols.

Before You Start

This section discusses the various requirements for the successful installation of the Router. In order to avoid difficulties please read and make sure you understand all the prerequisites for proper installation of your new ADSL Router.

Operating Systems

D-Link's Web-based management software can be used on PCs running Microsoft® Windows 95, Windows 98, Windows 98 SE, Windows Me, Windows 2000 and Windows NT.

ADSL Service

In order to use the Router you must first have ADSL service established with your local telephone company, or an Internet Service Provider (ISP). Contact your local telephone company for information on the availability of ADSL service in your area.

Micro-filters

Since ADSL and telephone services share the same copper wire to carry their respective signals, a filtering mechanism must be used to avoid mutual interference. You will need to install a micro-filter (low pass filter) device for each telephone that shares the line with the ADSL line. Micro-filters are easy to install in-line devices, which attach to the telephone cable between the telephone and wall jack. This device will not affect normal telephone services. Your telephone company will have more information regarding the use and installation of micro-filters.

Print this page for your records

VPI and VCI Settings

Your Telephone Company will provide two numbers, a Virtual Path Identifier (VPI) and a Virtual Channel Identifier (VCI). You will need to enter these two numbers during the configuration of the Router.

In order to ensure high quality of service and maximum performance, ADSL technology employs Asynchronous Transfer Mode (ATM) networks (via the DSLAM). ATM networks use Permanent Virtual Circuits (PVCs) to establish end-to-end software defined logical connections. The VPI and VCI are contained in the ATM cell header. These numbers help manage ATM network connections and identify logical links formed by PVCs.

For convenient reference, you may want to record the VPI and VCI numbers here, as well as the MAC (Physical) Address of the Router.

VPI, VCI and MAC Address

VPI _____ **VCI** _____

MAC Address _____

Global IP Address

Your ISP will supply you with a unique global IP address that you must use if you choose to connect to the ISPs network using the RFC 1483 defined "Bridged Ethernet" encapsulation method. If you use PPPoA to define the connection to your ISP you do not need to assign a global IP address. This is explained further in chapter 3 in the discussion of Connection Method.

Global IP Address _____ - _____ - _____ - _____

Default Gateway IP Address

Some ISPs require the use of a default gateway router. If this is necessary, your telephone company or ISP will provide the IP address of a device to be used for this purpose. Use the space provided below to record the IP address of the ISPs default gateway router.

Default Gateway IP Address _____ - _____ - _____ - _____

Print this page for your records

Introduction

This chapter describes the DSL-500 ADSL Router and its features and gives a brief introduction to ADSL technology.

Router Description and Operation

The DSL-500 ADSL Router is designed to provide a simple, cost-effective and secure ADSL Internet connection for your small to medium sized corporate LAN. The DSL-500 combines the benefits of high-speed ADSL connection technology and TCP/IP routing with a conventional Ethernet interface in one compact and convenient package. ADSL connection technology enables many interactive multimedia applications such as video conferencing and collaborative computing.

The Router is easy to install and use. The DSL-500 connects to an Ethernet LAN via a standard Ethernet 10BASE-T interface using RJ-45 connectors. The ADSL connection is made using ordinary twisted-pair telephone line with standard RJ-11 connectors. This arrangement means that several PCs can be networked and connected to the Internet. This also allows the creation of a virtual private network for telecommuter access to the LAN and company servers.

The Router can be used for IP packet routing over the WAN and also supports transparent bridging. Other cost saving capabilities of the Router include NAT (Network Address Translator) and DHCP (Dynamic Host Configuration Protocol).

ADSL Technology

Asymmetric Digital Subscriber Line (ADSL) is an access technology that utilizes ordinary copper telephone lines to enable broadband high-speed digital data transmission and interactive multimedia applications for business and residential customers. Using existing copper telephone lines forgoes the need for upgrading or adding expensive new cable.

ADSL devices use digital coding techniques that greatly increase the potential capacity of phone lines without interfering with regular telephone services. For the ADSL user, this means much faster data communications and the potential for interactive video capabilities. ADSL devices make it possible to enjoy benefits such as high-speed Internet access, telecommuting (remote LAN access), collaborative computing, distance learning, movies on demand and multi-player video gaming, without experiencing any loss of quality or disruption of voice/fax telephone capabilities.

ADSL provides a dedicated service over a single telephone line operating at speeds of up to 8 Mbps downstream (to the user) and up to 640 Kbps upstream (to the ISP), depending on local telephone line conditions. These conditions are ideal

for many user applications. A secure point-to-point connection is established between the user and the central office of the local telephone service provider. The user is always connected thus eliminating dial-up time and simplifying connectivity issues.

Product Features

The DSL-500 ADSL Router utilizes the latest ADSL enhancements and router technologies to provide a robust Internet gateway suitable for most small to medium sized offices.

PPP (Point-to-Point Protocol) Security

The DSL-500 ADSL Router supports PAP (Password Authentication Protocol) and CHAP (Challenge Handshake Authentication Protocol).

DHCP Support (Dynamic Host Configuration Protocol)

DHCP (Dynamic Host Configuration Protocol) allows IP addresses to be automatically and dynamically assigned to hosts on your network.

Network Address Translation (NAT)

For small office environments, the DSL-500 allows multiple users on the LAN to access the Internet concurrently through a single Internet account. This provides Internet access to everyone in the office for the price of a single user.

NAT address mapping can also be used to link two IP domains via a LAN-to-LAN connection.

TCP/IP (Transfer Control Protocol/Internet Protocol)

The DSL-500 supports TCP/IP protocol, the language used for the Internet. It is compatible with access servers manufactured by major vendors.

RIP-1/RIP-2

The DSL-500 supports both RIP-1 and RIP-2 exchanges with other routers. Using both versions will allow the Router to communicate with RIP enabled devices.

Static Routing

This allows you to select a data path to a particular network destination that will remain in the routing table and never "age out". This enables you to define a specific route that will always be used for data traffic from your LAN to a specific destination within your LAN (for example to another router or a server) or outside your network (to a ISP defined default gateway for instance).

Default Routing

This allows you to choose a default path for incoming data packets for which the destination address is unknown. This is particularly useful when the Router functions as the sole connection to the Internet.

ATM (Asynchronous Transfer Mode)

The DSL-500 supports *Bridged Ethernet over ATM* (RFC1483), *IP over ATM* (RFC1577) and *PPP over ATM* (RFC 2364), and *PPP Over Ethernet* (RFC 2516). The Router can support up to eight Virtual Circuit Connections (VCCs).

Precise ATM Traffic Shaping

Traffic shaping is a method of controlling the flow rate of ATM data cells. This function helps to establish the Quality of Service for ATM data transfer.

G.hs (Auto-handshake)

This allows the Router to automatically choose either the G.lite or G.dmt ADSL connection standards.

High Performance

Very high rates of data transfer are possible with the Router. Up to 8 Mbps downstream bit rate using G.dmt.

Full Network Management

The DSL-500 incorporates SNMP (Simple Network Management Protocol) support for web-based management and text-based network management via an RS-232 or **Telnet** connection.

Telnet Connection

The Telnet feature enables a network manager to access the Router's management software remotely.

Easy Installation

The DSL-500 uses a web-based graphical user interface program for convenient management access and easy set up. Any common web browser software can be used to manage the Router.

Standards Compatability and Compliance

The DSL-500 complies with or is compatible with the following standards as recognized by their respective agencies.

ITU G.994.1 (G.Hs *Auto-handshake*) compliant

ITU G.992.1 (G.dmt *Full-rate ADSL*) compliant

ITU G.992.2 (G.lite "*Splitterless ADSL*") compliant

ITU-T Rec. I.361 compliant

ITU-T Rec. I.610 compliant

Compatible with all T1.413 issue 2 (full rate DMT over analog POTS), and CO DSLAM equipment

RFC 1483 Multi-protocol over ATM "Bridged Ethernet" compliant

RFC 2364 *PPP over ATM* compliant

RFC 2516 *PPP over Ethernet* compliant

RFC 1334 PPP Authentication Protocol compliant

RFC 1994 Challenge Handshake Authentication Protocol compliant

RFC 791 *Internet Protocol* compliant

RFC 826 Address Resolution Protocol compliant

RFC 950 Internet Control Message Protocol compliant

RFC 1631 Net Address Translator compliant

Supports RFC 2131 and RFC 2132 DHCP functions including: automatic assignment of IP address, use of subnet mask and default gateway and provision of DNS server address for all hosts

IEEE 802.3 Ethernet compliant

IEEE 802.3u Fast Ethernet compliant

IEEE 802.1d Spanning Tree compliant

Supports RIP v1 and RIP v2

Supports Static Routing

Supports ATM Forum UNI V3.1 PVC

Minimum ATM cell forwarding rate: 640 Kbps

Supports up to eight simultaneous ATM virtual connections

Unpacking

Open the shipping carton and carefully remove all items. In addition to this User's Guide, ascertain that you have:

1. DSL-500 ADSL Router
2. DSL-500 tool kit on CD-ROM
3. RS-232 (DB-9 to DB-9) cable for console connection
4. Telephone cable with RJ-11 connectors for ADSL connection
5. AC power adapter suitable for your electric service
6. Category 5 Ethernet Cable

Front Panel

Place the Router in a location that permits an easy view of the LED indicators shown in the front panel diagram below.

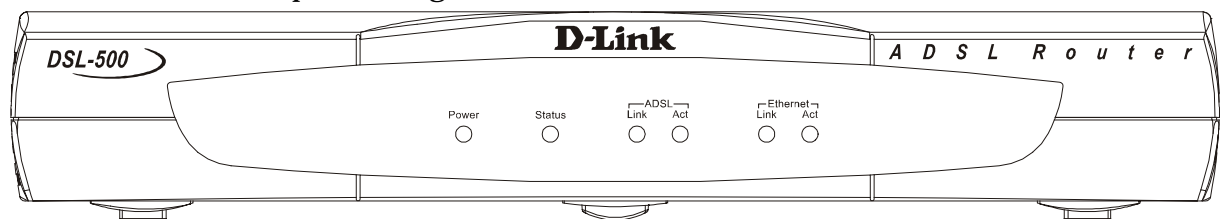

Figure 1-1 Front Panel

Rear Panel

The rear panel of the Router provides access to the AC power adapter cord connection as well as the port connections.

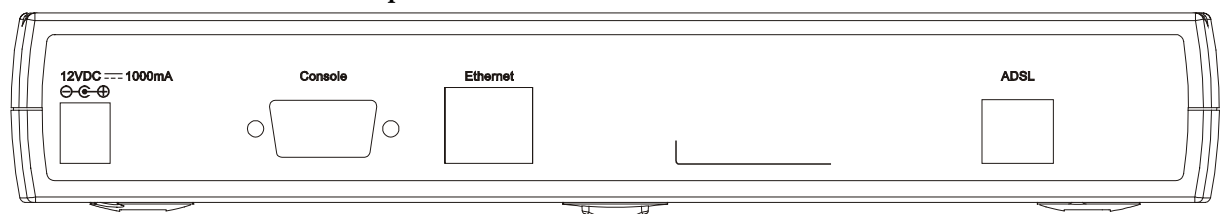

Figure 1-2 Rear Panel

LED Indicators

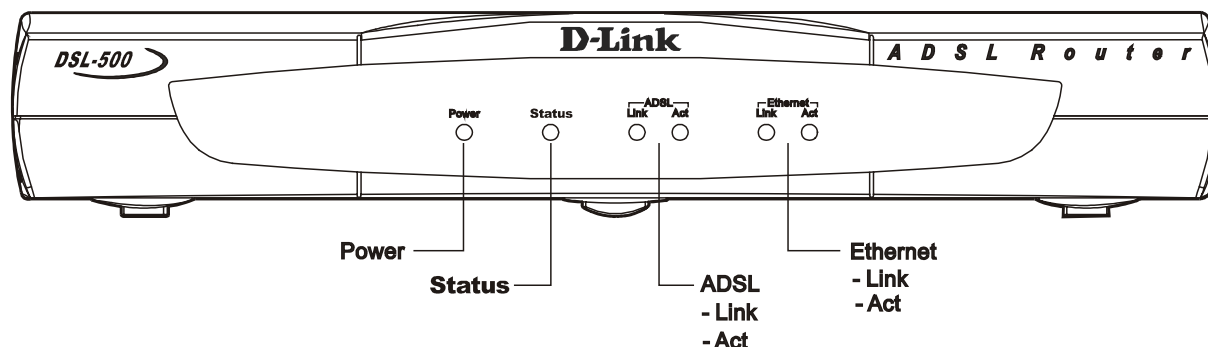

Figure 1-3 LED Indicators

The LED Indicators read as follows:

Power Steady green light indicates the unit is powered on.

Status Lights steady green during the ADSL negotiation phase. Once the connection status has been settled, the light will blink green.

ADSL: Link Steady green light indicates a valid ADSL connection. This will light after the ADSL negotiation process has been settled.

ADSL: Act Blinking green light indicates an active WAN session.

Ethernet: Link Steady green light indicates a valid Ethernet connection.

Ethernet: Act Blinking green indicates an active Ethernet session.

Hardware Installation

This chapter discusses the various connections you will need to make in order to use the Router.

When selecting the location for the Router, allow room to access the connections on the rear panel. You will want to place the Router so that you will be able to see the LED indicators on the front panel. Also, allow some space above the Router for ventilation to avoid problems with overheating.

It may be convenient for you to place the Router near the PC you intend to use for initial configuration of the Router. For initial configuration of the device, you may need convenient access to the RS-232 serial port on the rear panel. The RS-232 serial port is intended for use with text-based console management software for the initial configuration and for out-of-band management of the Router. Whether it is necessary to use an RS-232 console manager for first time set up depends on how you allocate IP addresses on your network. Read Chapter 3, *First Time Set Up* to help you decide how best to use the Router on your network.

Connect the Power

Insert the AC Power Adapter cord into the power receptacle located on the rear panel of the Router and plug the adapter into a nearby power source. You should see the Power LED indicator light up and remain lit.

Connect ADSL Line

Use the twisted-pair ADSL cable (standard telephone cable) included with the Router to connect it to your telephone line. Plug one end of the cable into the ADSL port (RJ-11 receptacle) on the rear panel of the Router and insert the other end into the telephone wall jack. The ADSL cable links the Router to the ISP's wide area network (including the Internet).

The Router must undergo a negotiation process to establish the terms of the ADSL connection. During this negotiation the Status LED will light a steady green, after which it will blink. If the ADSL line is disconnected, it will repeat this process.

Connect Ethernet LAN to Router

The Router may be connected to any 10BASE-T Ethernet LAN. Connection to an Ethernet concentrating device such as a switch or hub should use standard twisted-pair cable with RJ-45 connectors. The RJ-45 port on the Router is a straight-through (MDI-II) connection. Follow standard Ethernet guidelines when

deciding what type of cable to use to make this connection. Use a normal straight-through cable when connecting the Router to a normal (MDI-X) port on a switch or hub. Use a crossover cable when connecting it to an uplink (MDI-II) port on a hub or switch or a cross over converter with a straight through cable. When connecting the Router directly to a PC or server use a crossed cable. A steady green Ethernet Link LED indicator will indicate a valid connection.

The rules governing Ethernet cable lengths apply to the LAN to Router connection. Be sure that the cable connecting the Ethernet LAN to the Router does not exceed 100 meters.

The diagram below illustrates a typical Ethernet LAN to Router connection.

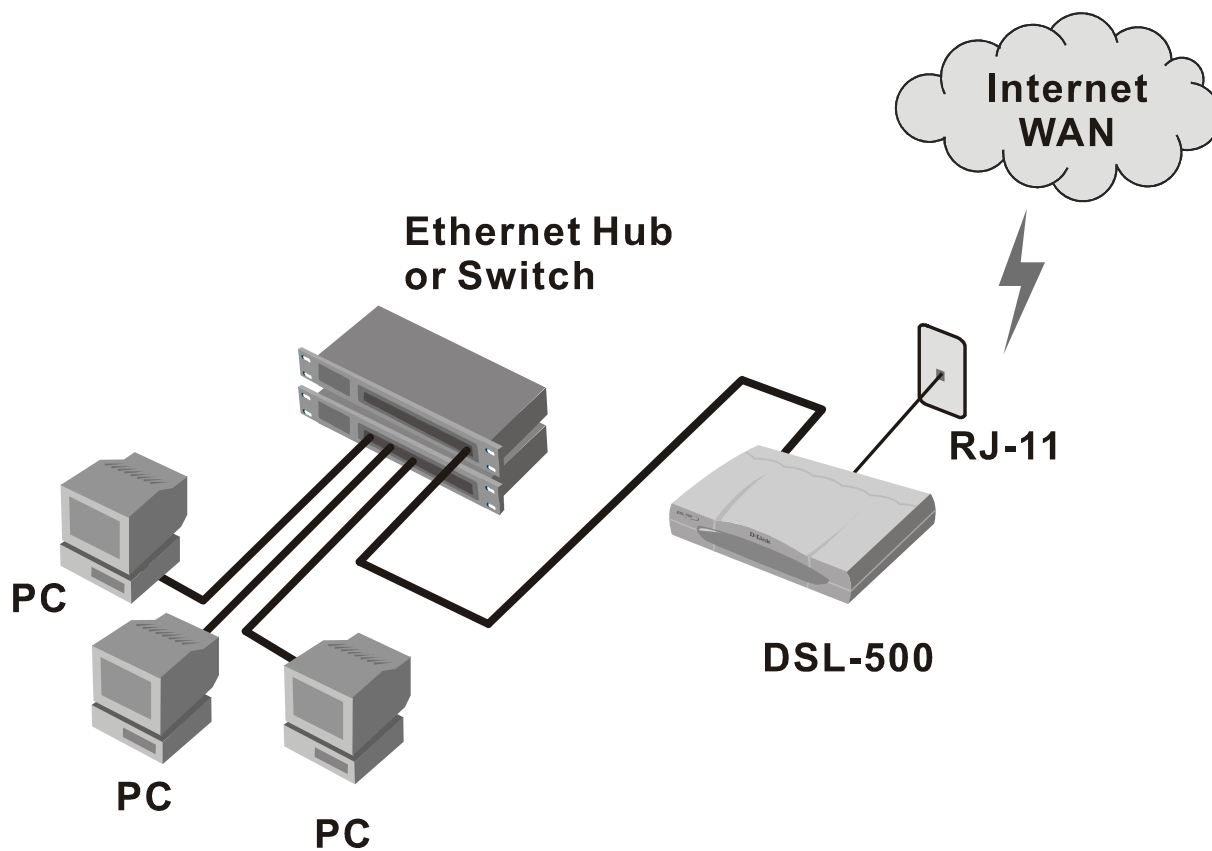

Figure 2-1 LAN to Router Connection

Connect Server or PC to Router

The Router may be connected directly to a server or PC using the RJ-45 Ethernet port. The diagram below illustrates a PC/Server to Router connection with the Router being employed as a firewall.

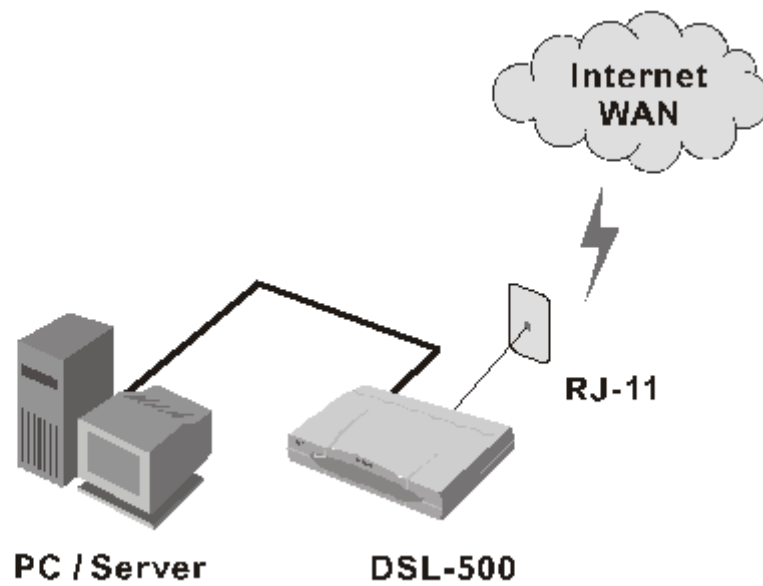

Figure 2-2 PC/Server to Router Connection

Web Based Router Management

Introduction

The DSL-500 offers an embedded Web-based (HTML) interface allowing users to manage the Router from anywhere on the network through a standard web browser, such as Netscape Navigator/Communicator or Microsoft Internet Explorer. The Web browser acts as a universal access tool and can communicate directly with the Router using the HTTP protocol. Your web browser window may vary with the screen captures (pictures) in this guide.

Note: This Web-based Management Module does not accept Chinese language input (or other languages requiring 2 bytes per character).

Getting Started

The web-based manager requires a java enabled web browser to manage the DSL-504. Web browsers such as the Netscape Communicator version 4 and above or the Internet Explorer versions 4.0 and above are operable.

Setting up the PC

Now that the physical connection is complete, you need to set the TCP/IP settings for your computer to properly connect to the DSL-500. Follow these simple steps.

Right-Click the “**Network Neighborhood**” (Win 98/98SE) or “**My Network Places**” (Win ME/2000) icon on your desktop and select “**Properties**.”

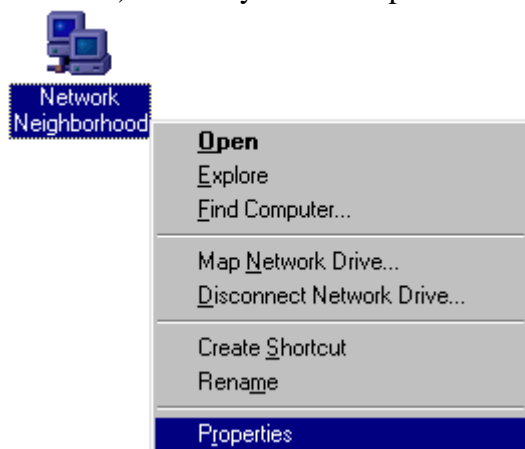

Highlight the line that reads “**TCP/IP**” and point to your installed Ethernet NIC.
Click “**Properties.**”

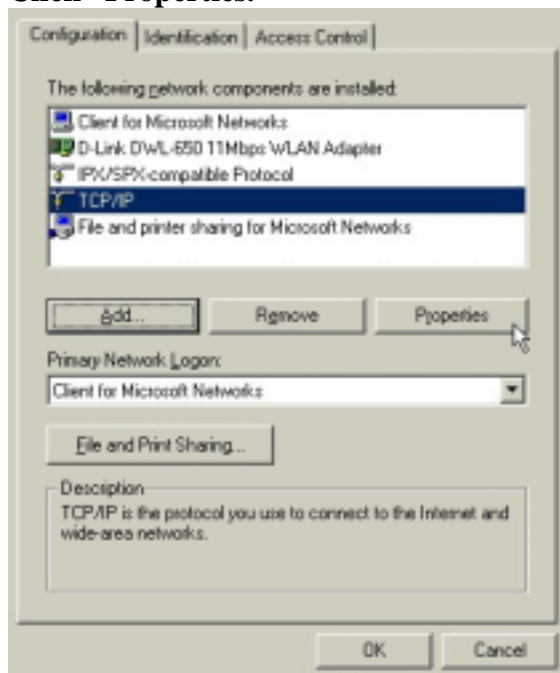

At this screen, select the IP Address tab.
Select “**Obtain an IP Address Automatically.**”
Click “**OK.**”

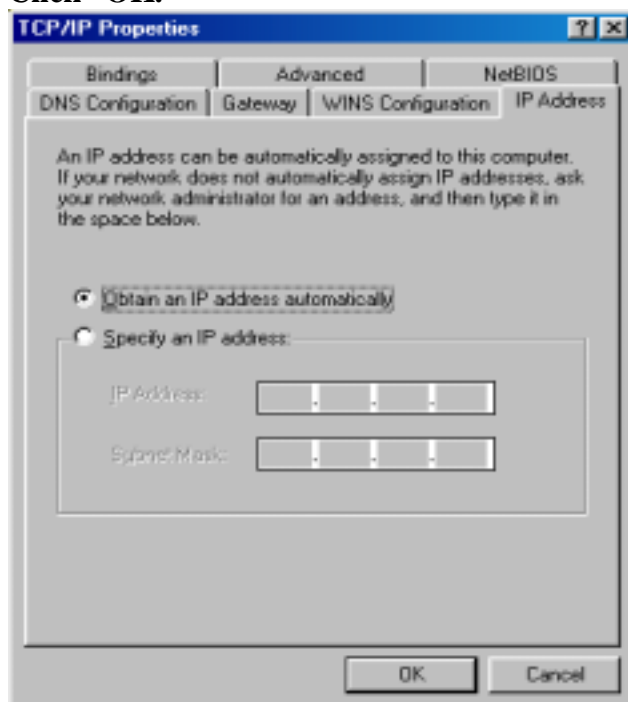

You will be prompted to reboot in Windows 98/98SE or ME
Click “**Yes.**”

For Windows 2000, restart your computer manually.

When your computer restarts, you will automatically receive an IP address from the DSL-500.

Management

In order to access the web-based management interface, it is necessary for both the PC (used for management) and the Router to be on the same IP subnet. You can either change the IP settings of the PC or change the IP address of the Router. See Chapter 3 for information about assigning IP addresses on the network and changing the IP address of the device. Appendix B contains a general discussion of IP addressing.

To use the web-based management software, run the browser you have installed on your computer and point it to the IP address defined for the device. The first time you access the web-based manager you will need to type the default IP address, **192.168.0.1**, in the address bar of the browser. The URL in the address bar should read: **http://192.168.0.1**. If you change the IP address of the router, then you will use the new IP address to access the web-based manager.

***Important Note:** In order to save any changes made to the Router (such as changing the IP address) you must go to the Save Changes window and save the configuration settings to non-volatile RAM.*

In the page that opens, click on the **Login to web-based management module** button:



Login Button

A new window will appear and you will be prompted for a user name and password. Use default user name **admin** and password **admin** for first time set up.

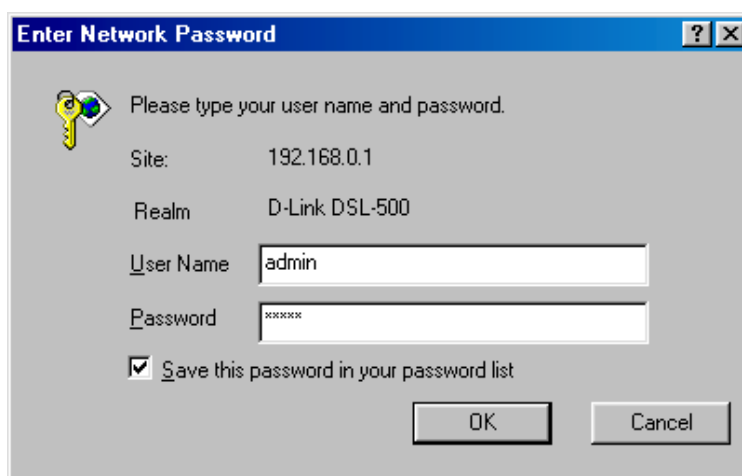

User Login

Logging in will bring up the main page of the web-based management module. Click the D-Link DSL-500 folder located below the D-Link logo in the upper left-hand corner. This folder will open revealing the management menu options. These options include **PPPoE Configuration, DHCP Configuration, NAT Configuration, Port Redirection, Advanced Filter/Firewall, Connection Type, Line Condition, Save Changes, Update Firmware** and **Summary**. The various management options are explained below.

After logging in, the web-based management module will automatically show the default settings. If you need to make changes to the configuration

PPPoE Configuration

The PPPoE connection method used by the Router is Point-to-Point-Protocol over Ethernet (PPPoE) as defined in RFC 2516. Use the PPPoE Configuration window to define the PVC by configuring the VPI and VCI values given to you by your DSL service provider. PPP also allows you to use the security protocols PAP or CHAP to help protect your network from unwanted intruders. This window is used to assign the user name and password used to access your network or server. When you have set the correct VPI and VCI settings and entered the user name and password, click the Connect button to establish the ADSL connection to your ISP's network. The window is also used to terminate the Router's ADSL connection and change connection methods.

If you wish to change the connection method (to Bridged Ethernet over IP), please read the section on Connection Method later in this chapter.

To bring up the PPPoE Configuration window, click on the PPPoE Configuration menu button and the following screen will appear:

D-Link DSL Router **DSL-500**

D-Link DSL-500

- PPPoE Configuration
- DHCP Configuration
- NAT Configuration
- Port Redirection
- Advanced Filter/Firewall
- Connection Type
- OAM Loopback Test
- Line Condition
- User Name and Password
- Save Changes
- Update Firmware
- Summary

PPPoE Configuration

PPPoE Login

Login User Name
Login Password
Authentication
Connect On Demand
Idle Time minutes

PPP Information

IP Address 0.0.0.0
Connection Status Disconnect

PVC

VPI
VCI

PPPoE Configuration Window

PVC

Use this field to assign the **VPI** and **VCI** values for the Router. These numbers are given to you by your ISP provider and must be entered correctly in order to establish the ADSL connection. If these values are not correct the connection will not be successful.

PPPoE Login

Use this field to assign a **Login User Name** and **Password** used to access to your ISP's network.

PPPoE Information

This field provides information regarding the status of the Router connection to the ISP's network. The ISP's DHCP server should assign the global IP Address for the Router automatically. The **Connection Status** will read Disconnect until you are connected to the ISP's WAN.

Connect to WAN

Once you have entered all the PVC and PPPoE Login values, click the Connect button to initiate the PPP connection via the ADSL WAN interface. The "handshake" process will take a few seconds. When the connection is established the status will be indicated in the PPPoE Information field.

DHCP

D-Link DSL Router **DSL-500**

D-Link DSL-500

- PPPoE Configuration
- DHCP Configuration
- NAT Configuration
- Port Redirection
- Advanced Filter/Firewall
- Connection Type
- OAM Loopback Test
- Line Condition
- User Name and Password
- Save Changes
- Update Firmware
- Summary

Dynamic IP Assignment

Start IP Address . . .

End IP Address . . .

Netmask . . .

Default Gateway . . .

Leased Time sec

DNS Server IP . . .

Domain Name

State

OK

DHCP Configuration Window

The Dynamic Host Configuration Protocol (DHCP) allows the Router to dynamically assign IP addresses to network devices. Dynamic IP assignment eliminates the need for the network administrator to maintain and monitor IP address assignments and simplifies IP use because IP addresses are automatically and dynamically assigned when a computer is powered-on.

Important Note: If you use DHCP to set your local IP addresses, the software IP settings of all stations on the network will need to be manually configured to 0.0.0.0., or, as in the case of Windows 95 users, the "Obtain an IP address automatically" option under TCP/IP will have to be selected.

Start IP Address

This is the base (starting) address for the IP pool of unassigned IP addresses.

End IP Address

This is the last address of the contiguous IP address range to be used by the Router for DHCP function.

Netmask

This mask informs the client how the destination IP address is to be divided into network, subnet, and host parts.

Default Gateway

This specifies the Gateway IP Address that will be assigned to and used by the DHCP clients.

Leased Time

The specified amount of time (in seconds) a client can lease an IP address, from the dynamically allocated IP pool. A value of 4123456789 means the lease is permanent.

DNS Server IP

Domain Name Service (DNS) servers are used on the Internet to match the Uniform Resource Locator (URL) for a website to its Internet IP address. For example, the URL: www.cnn.com, is a pseudonym for the IP address: 207.25.71.25. DNS entries allow users to access resources using URLs instead of IP addresses.

You may enter any Internet DNS server IP address available through the WAN connection. Your ISP should provide this address. (Note that without a DNS server IP, internet sites will only be available using IP addresses and will not be available using URLs.)

State

This toggles *Disable* and *Enable* for DHCP function.

NAT Configuration

D-Link DSL Router DSL-500

NAT Configuration

DMZ IP Address . . .

NAT Function

OK

NAT Configuration Window

Network Address Translation (NAT) is a routing protocol that allows your network to become a *private* network that is isolated from, yet connected to the Internet. It does this by changing the IP address of packets from a *global* IP address usable on the Internet to a *local* IP address usable on your private network (but not on the Internet) and vice-versa. The Router allows up to 253 host IP addresses.

NAT has two major benefits. First, NAT allows many users to access the Internet using a single global IP address. This can greatly reduce the costs associated with Internet access and also helps alleviate the current shortage of Internet IP addresses. Secondly, the NAT process creates a firewall, which hides your local network from Internet users, providing a degree of security to your Internet connection.

To be successfully implemented, NAT should be used only when the majority of network traffic remains on the local network. In cases where a large percentage of network traffic is destined for the Internet, NAT can adversely affect the speed and performance of your Internet connection. Network servers such as ftp servers, web servers or mail servers should use the port redirection capabilities of the Router.

NAT will work in conjunction with DHCP and Port Redirection. Thus, if both are enabled and properly configured, the DHCP server in the DSL-500 will assign local IP addresses to computers on your network. The Port Redirection feature allows an administrator to direct specific types of incoming packets to another server or designated host. For example, a common way to use Port Redirection would be to direct incoming HTTP packets (through TCP logical port 80) and redirect them to an HTTP server (conventionally through port 8080).

How NAT Works

In the most common NAT configuration, your network uses local IP addresses that are not valid on the Internet. Each Internet (global) IP address is unique. Your network administrator can assign local IP addresses on your network (within guidelines defined later in this chapter and in “Appendix B, IP Concepts”). This can be done manually or by using DHCP. The WAN port on the router is assigned a globally unique public IP Address that is valid on the Internet, since it will be sending and receiving data directly to the Internet and is therefore part of it. Please study the example diagram below carefully.

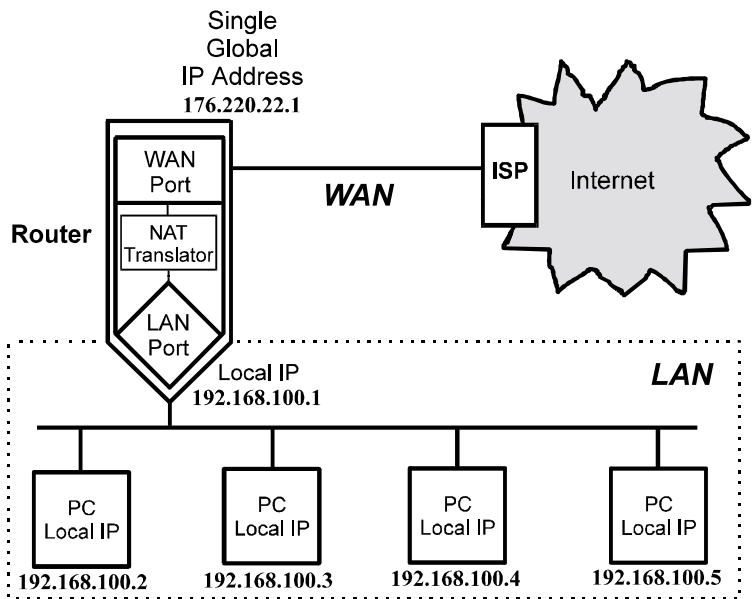

Please note that in the above diagram, the Gateway IP address settings for the local PC's needs to be set to 192.168.0.1, the LAN IP address of the router.

NAT manipulates the IP addresses in packet headers on a one-to-one basis. An outgoing data packet (a packet originating from a computer on the local LAN and destined for a computer outside the private network) will have its IP address translated as shown below.

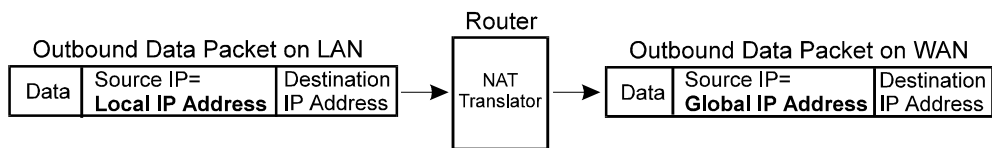

In the Outgoing Data Packet above, the *Source IP address* is the IP address that is translated by NAT. The *Destination IP Address* is the IP address of a computer outside the private network, on the Internet for example. And the *Data* portion of the packet is the information payload carried by the packet, for instance a request to view a web page.

The router logs the changes made to the IP header in its NAT table. The NAT table enables the router to send replies back to the local computer as shown below.

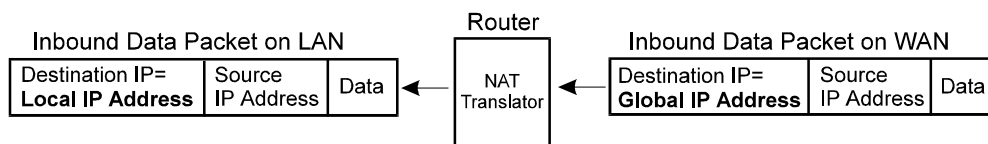

In the Inbound Data Packet above, the *Destination IP Address* is the IP address that is translated by NAT. The *Source IP Address* is the IP address of a computer outside the private network. And the *Data* portion of the packet is the information payload carried by the packet, in this case, web page contents.

Setting Local IP Addresses

When implementing NAT and thus creating a private network that is isolated from the Internet, you can assign any IP addresses to host computers without problems. However, the Internet Assigned Numbers Authority (IANA) has reserved the following three blocks of IP Addresses specifically for private networks:

Class	Beginning Address	Ending Address
A	10.0.0.0	10.255.255.255
B	172.16.0.0	172.31.255.255
C	192.168.0.0	192.168.255.255

It is recommended that you choose local IP addresses for use with NAT from the private network IP addresses in the above list. For more information on address assignment, refer to RFC 1597, *Address Allocation for Private Internets* and RFC 1466, *Guidelines for Management of IP Address Space*.

Port Redirection

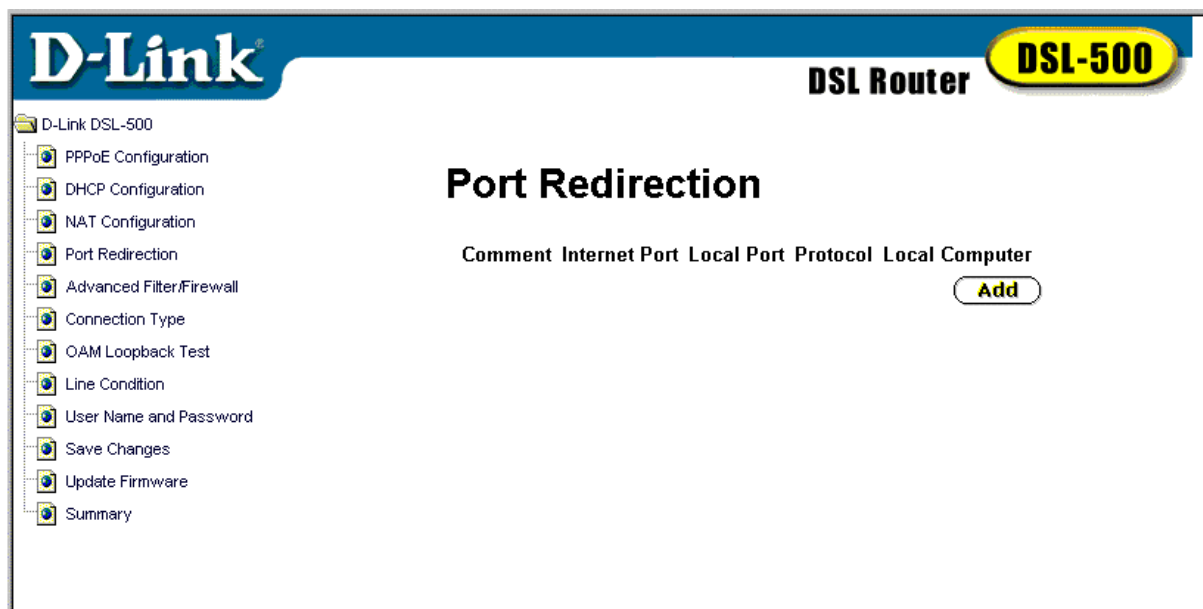

Port Redirection Window

The Port Redirection feature of the Router is used in conjunction with NAT to improve security and efficiency. For example, this can be used to direct HTTP packets to a designated HTTP server as a form of firewall protection for the LAN.

Other common applications might include directing incoming SMTP packets to an Email server. Click Add in the Port Redirection window to access the Redirect Port window pictured below.

D-Link DSL Router **DSL-500**

D-Link DSL-500

- PPPoE Configuration
- DHCP Configuration
- NAT Configuration
- Port Redirection
- Advanced Filter/Firewall
- Connection Type
- OAM Loopback Test
- Line Condition
- User Name and Password
- Save Changes
- Update Firmware
- Summary

Redirect Port -- Add

Comment

Internet Port

Local Port

Protocol

Local Computer . . .

OK

Redirect Port Window

The Redirect Port window presents five entry fields. The first field, **Comment** can be used to assign an appropriate name to the new route, for our example we will use the name *HTTP Server*. In the **Internet Port** field enter the designated TCP or UDP protocol port number for the particular protocol packet you wish to redirect. In our example an incoming HTTP packets use port 80. The local port is the port used by the designated host on the LAN. In this case an HTTP server, conventionally port 8080 is used for this purpose. Choose the protocol, either TCP or UDP from the pull-down **Protocol** menu. HTTP is defined within TCP. In the **Local Computer** field supply the IP address of the local designated host computer or device. Using our example you would enter the IP address of the HTTP server.

Advanced Filter/Firewall

The Router features IP address filtering for improved network security. Incoming or outgoing IP packets can be blocked and discarded. This allows you to restrict communications from specific outside global IP addresses from entering your network. You may also use it to restrict any specific host on the LAN from accessing the Internet. The Router uses up to twelve IP filter sets and each set contains up to seven filter environments for defining the terms of filtering.

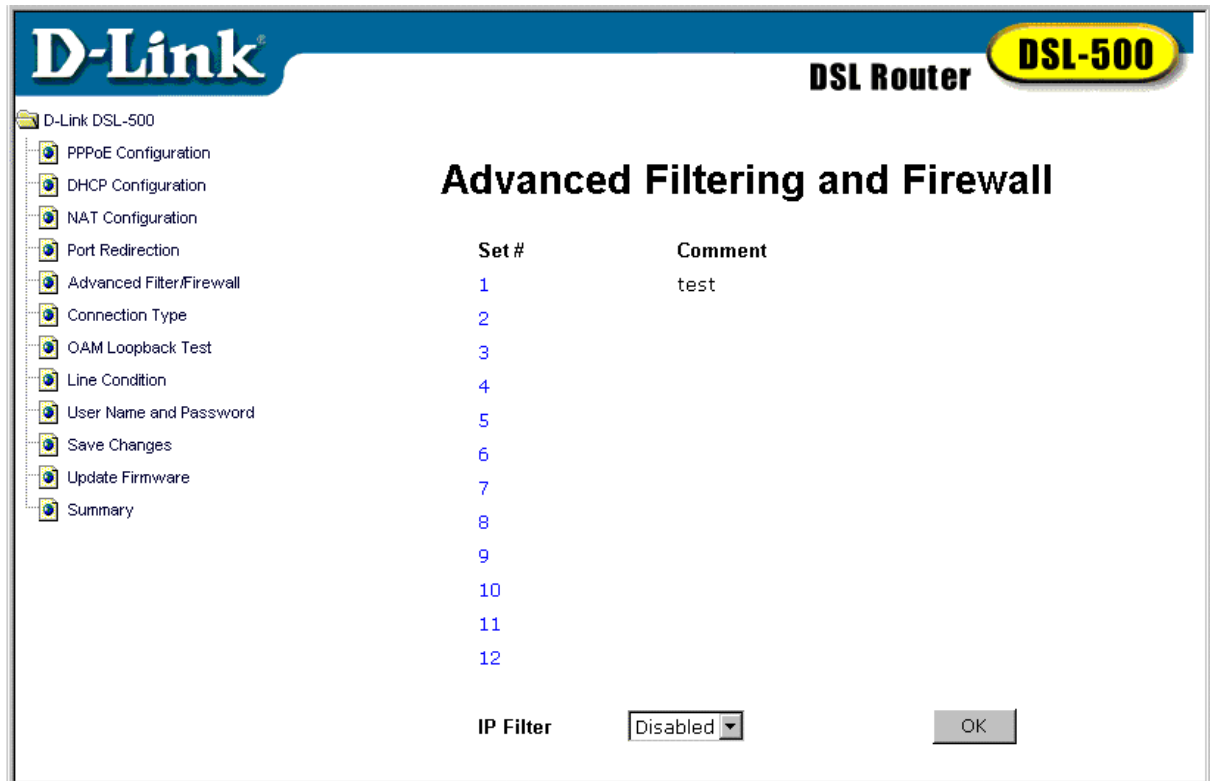

Advanced Filtering and Firewall (Screen #1)

In the first window of the Advanced Filtering and Firewall feature choose *Enable* from the **IP Filter** pull down menu and click OK to enable IP filtering. Then click on the set number you wish to configure to proceed to the next window.

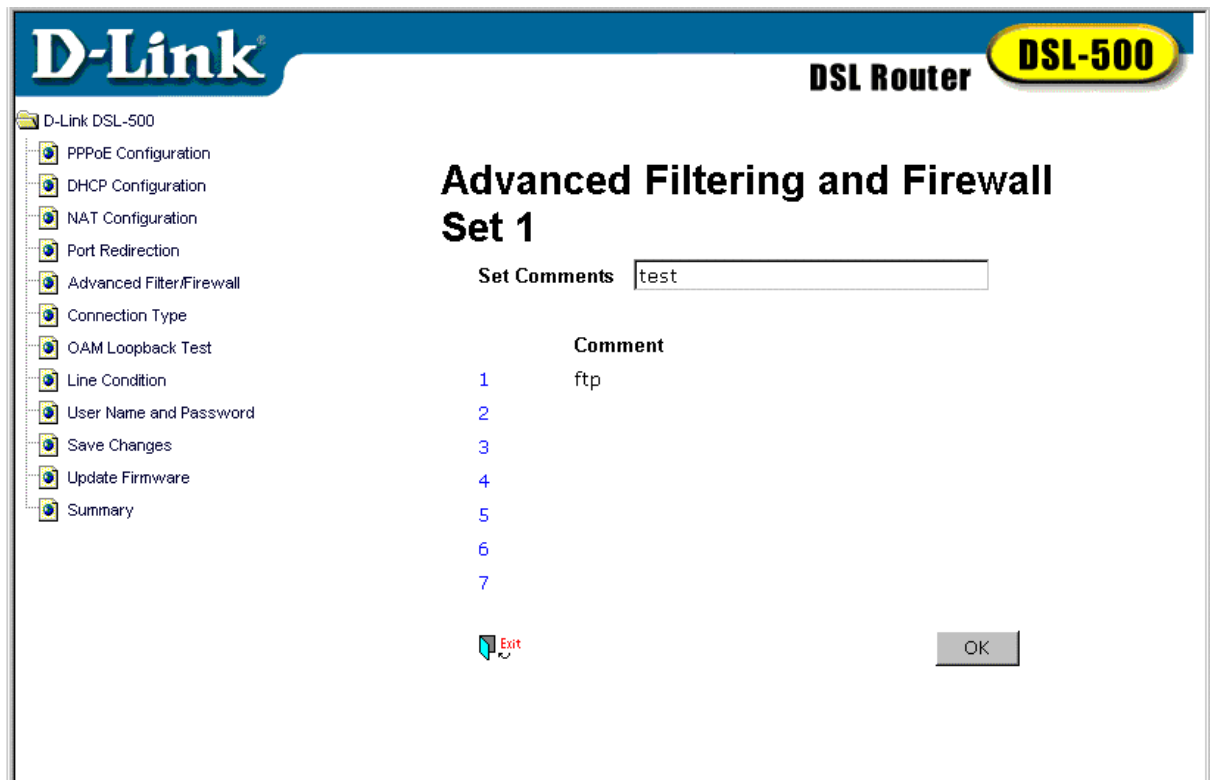

Advanced Filtering and Firewall (Screen #2)

In the second Advanced Filtering window you can supply a comment or name of up to 15 characters for the set in the **Set Comments** field. Click OK to save the comments. Next click on the number of the subset you want to configure to proceed to the next window.

The screenshot shows the 'Advanced Filtering and Firewall' configuration page for 'Set 1 - Rule 1' on a D-Link DSL-500 router. The interface includes a left-hand navigation menu with options like PPPoE Configuration, DHCP Configuration, NAT Configuration, Port Redirection, Advanced Filter/Firewall (selected), Connection Type, OAM Loopback Test, Line Condition, User Name and Password, Save Changes, Update Firmware, and Summary. The main configuration area contains the following fields:

- Comment:** A text box containing 'ftp' and a checkbox labeled 'Click to enable the Filter Rule' which is checked.
- Pass or Block:** A dropdown menu set to 'Pass Immediately'.
- Direction:** A dropdown menu set to 'In'.
- Protocol:** A dropdown menu set to 'UDP'.
- IP Address and Subnet Mask:**
 - Source:** IP address '0.0.0.0' and Subnet Mask '255.255.255.0 (/24)'.
 - Destination:** IP address '192.168.0.116' and Subnet Mask '255.255.255.0 (/24)'.
- Start Port and End Port:**
 - Source:** Start Port '0' and End Port '0'.
 - Destination:** Start Port '20' and End Port '21'.

At the bottom left, there is an 'Exit' button with a red arrow icon. At the bottom right, there is an 'OK' button.

Advanced Filtering and Firewall (Screen #3)

In the third Advanced Filtering window you will define the terms or rule to be used for filtering a specific IP address. Again you can supply a name for the subset in the **Comment** field and click the box on the right to enable the **Filter Rule**.

In the **Pass or Block** field select the action to be performed on the IP packets, the default is *Pass Immediately*. Any blocked packets are simply dropped.

In the **Direction** field choose either *In* or *Out* from the pull down menu. Which one you choose depends on whether you are blocking IP packets from coming into the network (blocking a specific web site for example). Or alternatively you can block packets originating at a specific IP address from leaving the LAN; this will block Internet access for a specific host.

The **Protocol** field allows you to define the type of protocol of the packets to be blocked.

You must next specify the **Source** and **Destination IP Addresses** as well as their **Subnet Mask**. This will block the packets from or destined to any specified IP address from passing through the Router.

Finally you can specify individual protocol ports or an entire range of protocol ports to be blocked for the **Source** or **Destination**. Type the **Start Port** number in either the Source or Destination row. If there is no port specified in the Start Port column, the filter rule will be ignored. Use the <, >, = or ≠ in the pull down menu to specify the port or range of ports to be filtered. Use the following guide to define the port or port range:

- < : specifies the port numbers less than and equal to the Start Port number
- > : specifies the port numbers greater than and equal to the Start Port number
- = : sets the port number equal to the Start Port if there is no End Port specified; if an End Port number is specified, this defines a range of ports to filter. The range is defined as the port numbers between the Start Port and End Port, including the Start and End Port numbers.
- ≠ : the port number does not equal the Start Port if there is no End Port specified; if an End Port number is specified, this defines a range of ports not to filter. The range is defined as the port numbers between the Start Port and End Port, including the Start and End Port numbers.

Connection Type

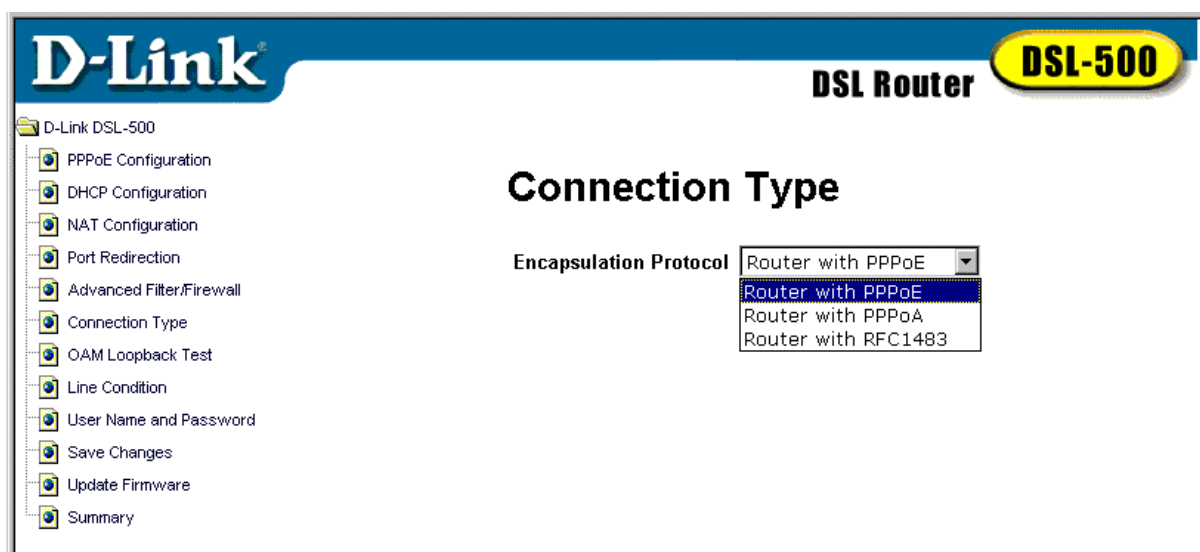

Connection Type (PPPoE/PPPoA/ RFC 1483) Window

The connection method used by the Router for the ADSL connection to the ISPs network is PPP over Ethernet, ATM, or Router with RFC 1483. If changes are made with the connection type, click on save changes in the left column and the click save configuration to store the new configurations.

To change the connection method, select from the pull down menu in the Encapsulation Protocol under Connection Type. Make the selection and click **OK**.

Static IP Address Configuration

The screenshot shows the web-based configuration interface for a D-Link DSL-500 ADSL Router. The interface has a blue header with the D-Link logo on the left and 'DSL Router' and 'DSL-500' on the right. A left-hand navigation menu lists various configuration options: Static IP Address Configuration, DHCP Configuration, NAT Configuration, Port Redirection, Advanced Filter/Firewall, Connection Type, OAM Loopback Test, Line Condition, User Name and Password, Save Changes, Update Firmware, and Summary. The main content area is titled 'Static IP Address' and contains the following fields:

- IP Address:** Four input boxes, each containing the digit '0', separated by dots.
- Subnet Mask:** Four input boxes, each containing the digit '0', separated by dots.
- Default Gateway:** Four input boxes, each containing the digit '0', separated by dots.
- DHCP client:** A checkbox that is currently unchecked.
- PVC:** A section header followed by two input boxes:
 - VPI:** An input box containing the digit '0'.
 - VCI:** An input box containing the digit '0'.

An 'OK' button is located at the bottom right of the configuration area.

Static IP Address Configuration Window

In the Static IP Address Configuration window you will need to enter the global IP address and subnet mask assigned to you by your ISP. If the ISP gives you a default gateway IP address enter that here as well.

You must also supply the **VPI** and **VCI** given to you by your ISP. Check the values for all of the entries in this window to be certain that they are correct and click OK.

Line Condition

D-Link DSL Router **DSL-500**

D-Link DSL-500

- PPPoE Configuration
- DHCP Configuration
- NAT Configuration
- Port Redirection
- Advanced Filter/Firewall
- Connection Type
- OAM Loopback Test
- Line Condition**
- User Name and Password
- Save Changes
- Update Firmware
- Summary

Line Condition

Data Path	Fast
Operation Mode	T1.413
Rate	
Downstream	0
Upstream	0
Near end	
FEC	0
CRC	0
HEC	0
Far end	
FEC	0
CRC	0
HEC	0

[Refresh](#)

Line Condition

In the statistics window you can monitor the characteristics of the ADSL connection. From this window you can observe various performance statistics of each end of the connection. These include:

Data Path: Displays the current data path type, *Fast* or *Interleaved*.

Operation Mode: Describes the modulation technique used to make the ADSL connection. This will be either Discrete Multi-tone modulation (DMT) defined by the *G.dmt* standard or DMT described by the *G.lite* standard.

Downstream Rate: Lists the downstream data transfer rate in Kbps.

Upstream Rate: Lists the upstream data transfer rate in Kbps.

Near End (ADSL Router connection a.k.a. ATU-R): Lists the number of data transfer errors on the Router end of the ADSL connection. These errors are listed according to the technique used to correct them. The techniques used are **Forward Error Correction (FEC)**, **Cyclic Redundancy Control (CRC)** and **Header Error Check (HEC)**.

Far End (DSLAM): Lists the number of data transfer errors on the DSLAM end of the ADSL connection. These errors are listed according to the technique used to correct them. The techniques used are **Forward Error Correction (FEC)**, **Cyclic Redundancy Check (CRC)** and **Header Error Control (HEC)**.

User Name and Password

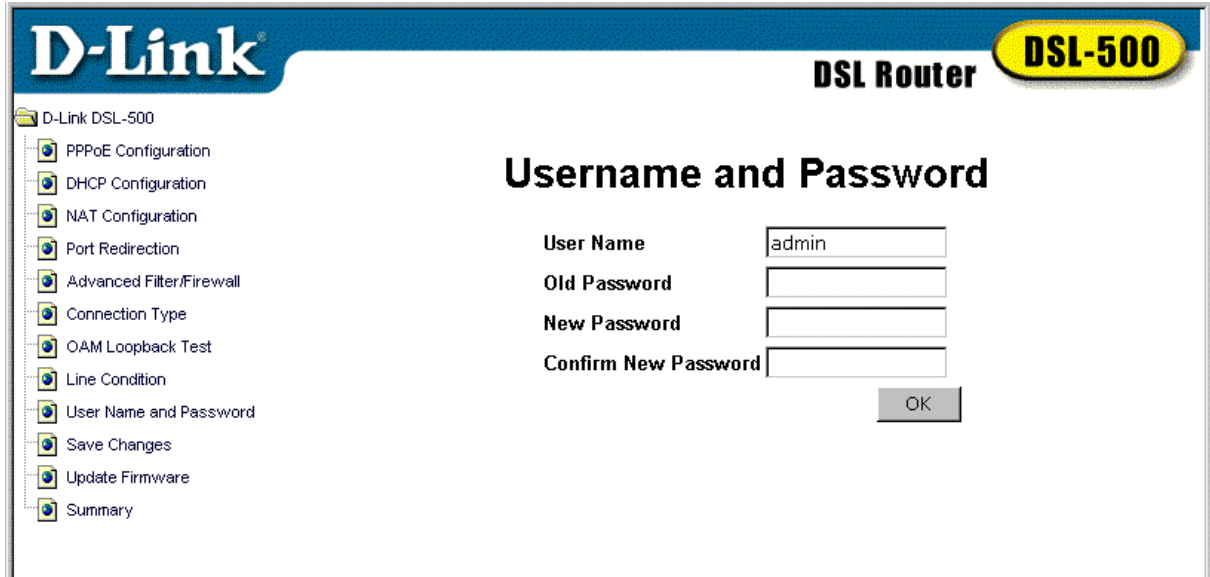

The screenshot shows the D-Link DSL-500 web-based manager interface. The top navigation bar includes the D-Link logo, 'DSL Router', and 'DSL-500'. A left sidebar lists various configuration options: PPPoE Configuration, DHCP Configuration, NAT Configuration, Port Redirection, Advanced Filter/Firewall, Connection Type, OAM Loopback Test, Line Condition, User Name and Password (selected), Save Changes, Update Firmware, and Summary. The main content area is titled 'Username and Password' and contains four input fields: 'User Name' (with 'admin' entered), 'Old Password', 'New Password', and 'Confirm New Password'. An 'OK' button is located at the bottom right of the form.

User Name and Password Window

Use this window to change the **User Name** and **Password** used to access the web-based manager. Type the new **User Name** and **Old Password** in their respective fields. Type the **New Password** and confirm it in the **Confirm New Password** field and click OK.

If you have forgotten your user name or password you can use the out-of-band console manager to access this information. For details on how to use the console manager to find the user name and password, see Chapter 5.

Save Changes

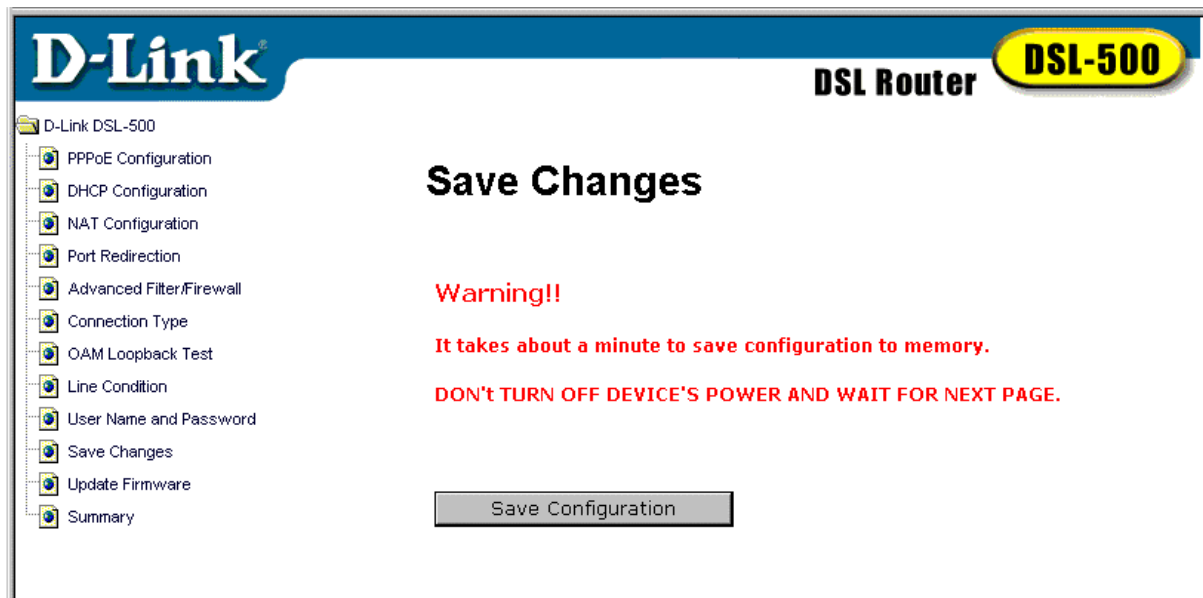

Save Changes Window

In order to save the configuration changes that have been made to the Router you must save them to the Router's non-volatile RAM. If you do not save the changes the configuration settings will be lost in the event of a power loss or system halt.

Restart System

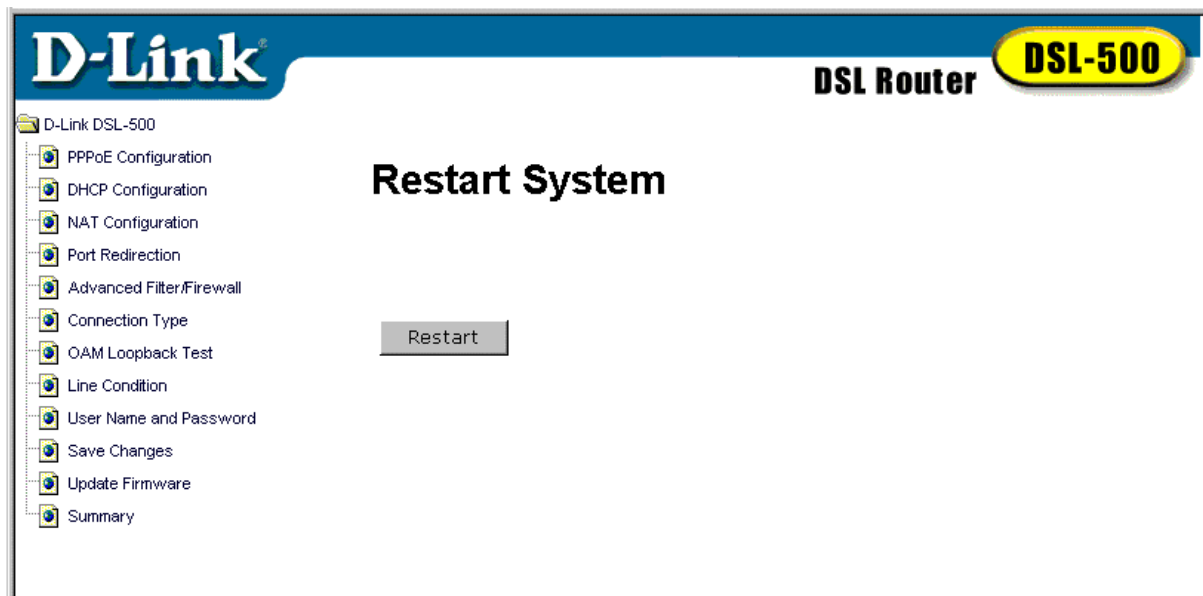

Restart System Window

Click Restart to apply new configuration settings made to the Router.

Update Firmware



Update Firmware Window

In order to keep pace with changes in ADSL standards and technology the DSL-500 allows you to easily update the embedded firmware. You may obtain the latest version of the DSL-500 firmware by logging onto the D-Link web site at www.dlink.com. If you are connected to the Internet, you can access the D-Link web site by clicking on the blue URL in the Update Firmware window.

The Update Firmware window lists the version of the firmware the Router is currently using. If you would like to update, follow the instructions given on the D-Link web site firmware update page to download the new firmware. You can then use the DSL-500 Firmware Upgrade Utility included with the Router to transfer the new firmware to the Router. For instructions on using the Upgrade Utility software please read Appendix C.

The Installation CD-ROM included with the Router contains an installation file for the DSL-500 Firmware Upgrade Utility. You should install this on the computer you will use to make the occasional upgrades. Click on the setup.exe file and the utility will be automatically installed.

Summary



Figure 3-11 Summary

This page provides summary statistics of the various features of the Router. The list includes: **PPPoE Login**, (PPPoA Information will be displayed when using PPPoA connection method), **PVC**, **Connection Method**, **DHCP Configuration** and **NAT Configuration**.

!Note: If your connection type is set to PPPoA, then you will see the summary of PPPoA information.

4

Saving Changes

To save changes made to the Router configuration type **config save** and press Enter, the current settings will be saved to nonvolatile RAM.

Finding the Password

If you forget the user name and password that allows you to access the web-based manager you can retrieve this information using the console terminal interface. To do this type **flashfs cat initweb** and you will see the user name and password listed.

Contacting Technical Support

D-Link provides free technical support for customers within the United States. U.S. customers can contact D-Link technical support through our web site, e-mail, or by phone.

United States technical support is available Monday through Friday from 6:00 a.m. to 6:00 p.m. (PST).

Web:

<http://www.dlink.com>

Email:

support@dlink.com

Phone:

949-788-0805 (option #4)

If you are a customer residing outside of the United States, please refer to the list of D-Link locations that is included in this manual.

Thank you for purchasing this product. We like to receive feedback from our customers concerning our products. Please take a moment to visit our web site. You can register your purchase on-line, learn more about the newest networking products, and let us know the things your new network has empowered you to do.

D-Link[®] Offices

- AUSTRALIA D-LINK AUSTRALASIA**
Unit 16, 390 Eastern Valley Way, Roseville, NSW 2069, Australia
TEL: 61-2-9417-7100 FAX: 61-2-9417-1077
TOLL FREE: 1800-177-100 (Australia), 0800-900900 (New Zealand)
URL: www.dlink.com.au
E-MAIL: support@dlink.com.au, info@dlink.com.au
- CANADA D-LINK CANADA**
2180 Winston Park Drive, Oakville, Ontario L6H 5W1 Canada
TEL: 1-905-829-5033 FAX: 1-905-829-5223 BBS: 1-965-279-8732
FREE CALL: 1-800-354-6522
URL: www.dlink.ca
FTP: ftp.dlinknet.com
E-MAIL: techsup@dlink.ca
- CHILE D-LINK SOUTH AMERICA**
Isidora Goyenechea #2934 of.702, Las Condes, Santiago, Chile
TEL: 56-2-232-3185 FAX: 56-2-2320923
URL: www.dlink.cl
E-MAIL: ccasassu@dlink.cl, tsilva@dlink.cl
- DENMARK D-LINK DENMARK**
Naverland 2, DK-2600 Glostrup, Copenhagen, Denmark
TEL:45-43-969040 FAX:45-43-424347
URL: www.dlink.dk
E-MAIL: info@dlink.dk
- EGYPT D-LINK MIDDLE EAST**
7 Assem Ebn Sabet Street, Heliopolis Cairo, Egypt
TEL: 202-2456176 FAX: 202-2456192
URL: www.dlink-me.com
E-MAIL: support@dlink-me.com, fateen@dlink-me.com
- FRANCE D-LINK FRANCE**
Le Florilege #2, Allee de la Fresnerie
78330 Fontenay Le Fleury France
TEL: 33-1-30238688 FAX: 33-1-3023-8689
URL: www.dlink-france.fr
E-MAIL: info@dlink-france.fr
- GERMANY D-LINK CENTRAL EUROPE/D-LINK DEUSTSCHLAND GMBH**
Schwalbacher Strasse 74, 65760 Eschborn Germany
TEL: 49-(0) 6196-7799-0 FAX: 49-(0) 6196-7799-300
URL: www.dlink.de
E-MAIL: mbischoff@dlink.de, mboerner@dlink.de
- INDIA D-LINK INDIA**
Plot No.5, Kurla-Bandra Complex Road,
Off Cst Road, Santacruz (E), Bombay - 400 098 India
TEL: 91-22-652-6696 FAX: 91-22-652-8914
URL: www.dlink-india.com
E-MAIL: service@dlink.india.com
- ITALY D-LINK ITALY**
Via Nino Bonnet No. 6/b, 20154 Milano, Italy
TEL: 39-02-2900-0676
FAX: 39-02-2900-1723
E-MAIL: info@dlink.it
URL: www.dlink.it
- JAPAN D-LINK JAPAN**
10F, 8-8-15 Nishi-Gotanda, Shinagawa-ku, Tokyo 141 Japan
TEL: 81-3-5434-9678
FAX: 81-3-5434-9868

URL: www.d-link.co.jp
E-MAIL: kida@d-link.co.jp

RUSSIA

D-LINK RUSSIA

Michurinski Prospekt 49, 117607 Moscow, Russia
TEL: 7-095-737-3389, 7-095-737-3492 FAX: 7-095-737-3390
E-MAIL: vl@dlink.ru

SINGAPORE

D-LINK INTERNATIONAL

1 International Business Park, #03-12 The Synergy, Singapore 609917
TEL: 65-774-6233 FAX: 65-774-6322
URL: www.dlink-intl.com
E-MAIL: info@dlink.com.sg

S. AFRICA

D-LINK SOUTH AFRICA

Unit 2, Parkside 86 Oak Avenue
Highveld Technopark Centurion, Gauteng, Republic of South Africa
TEL: 27(0)126652165 FAX: 27(0)126652186
CELL NO: 0826010806 (Bertus Moller)
CELL NO: 0826060013 (Attie Pienaar)
E-MAIL: bertus@d-link.co.za, attie@d-link.co.za

SWEDEN

D-LINK SWEDEN

P.O. Box 15036, S-167 15 Bromma Sweden
TEL: 46-(0)8564-61900
FAX: 46-(0)8564-61901
E-MAIL: info@dlink.se
URL: www.dlink.se

TAIWAN

D-LINK TAIWAN

2F, No. 119 Pao-Chung Road, Hsin-Tien, Taipei, Taiwan
TEL: 886-2-2910-2626
FAX: 886-2-2910-1515
URL: www.dlinktw.com.tw
E-MAIL: dssqa@tsc.dlinktw.com.tw

U.K.

D-LINK EUROPE

D-Link (Europe) Ltd. 4th Floor Merit House,
Edgware Road, Colindale, London NW95AB U.K.
TEL: 44-20-8731-5555 FAX: 44-20-8731-5511
URL: www.dlink.co.uk
E-MAIL: info@dlink.co.uk

U.S.A

D-LINK U.S.A.

53 Discovery Drive, Irvine, CA 92618 USA
TEL: 1-949-788-0805 FAX: 1-949-753-7033
INFO LINE: 1-800-326-1688
BBS: 1-949-455-1779, 1-949-455-9616
URL: www.dlink.com
E-MAIL: tech@dlink.com, support@dlink.com



Technical Specifications

General		
Standards:	ITU G.992.1 (G.dmt) ITU G.992.2 (G.lite) ITU G.994.1 (G.Hs) ITU-T Rec. I.361 ITU-T Rec. I.610 IEEE 802.3 IEEE 802.3u IEEE 802.1d RFC 791 (IP Routing) RFC 792 (UDP) RFC 826 (ARP) RFC 1058 (RIP 1) RFC 1389 (RIP 2) RFC 1213 compliant RFC 1483 (Bridged Ethernet) RFC 1577 (IP over ATM)	RFC 1661 (PPP) RFC 1994 (CHAP) RFC 1334 (PAP) RFC 2364 (PPP over ATM) RFC 1631 (NAT) RFC 1877 (Automatic IP assignment) RFC 2516 (PPP over Ethernet) Supports RFC 2131 and RFC 2132 (DHCP) Compatible with all T1.413 issue 2 (full rate DMT over analog POTS), and CO DSLAM equipment Supports ATM Forum UNI V3.1 PVC
Protocols:	TCP/IP UDP RIP-1 RIP-2 IGMP	DHCP BOOTP ARP AAL5
Data Transfer Rate:	G.dmt full rate: Downstream up to 8 Mbps Upstream up to 640 Kbps G.lite: Downstream up to 1.5 Mbps Upstream up to 512 Kbps	

General	
Media Interface Exchange:	RJ-11 port ADSL telephone line connection RJ-45 port for 10BASET Ethernet connection RS-232 (DB9 female) console port for local configuration

Physical and Environmental	
DC inputs: Power Adapter:	Input: 120V AC 60Hz 24W Output: 12V DC 1.0 A
Power Consumption:	10 Watts (max)
Operating Temperature:	0° to 50° C (32° - 122° F)
Humidity:	5 to 95% (non-condensing)
Dimensions:	215 mm x 163 mm x 45 mm
Weight:	455 gm (1 lb.)
EMI:	CE Class B FCC Class B
Safety:	UL/CUL TUV
Reliability:	Mean Time Between Failure (MTBF) min. 4 years



IP Concepts

This appendix describes some basic IP concepts, the TCP/IP addressing scheme and shows how to assign IP Addresses.

When setting up the Router, you must make sure it has a valid IP address. Even if you will not use the WAN port (ADSL port), you should, at the very least, make sure the Ethernet LAN port is assigned a valid IP address. This is required for telnet, in-band SNMP management, and related functions such as “trap” handling and TFTP firmware download.

IP Addresses

The Internet Protocol (IP) was designed for routing data between network sites all over the world, and was later adapted for routing data between networks within any site (often referred to as “subnetworks” or “subnets”). IP includes a system by which a unique number can be assigned to each of the millions of networks and each of the computers on those networks. Such a number is called an IP address.

To make IP addresses easy to understand, the originators of IP adopted a system of representation called “dotted decimal” or “dotted quad” notation. Below are examples of IP addresses written in this format:

201.202.203.204 189.21.241.56 125.87.0.1

Each of the four values in an IP address is the ordinary decimal (base 10) representation of a value that a computer can handle using eight “bits” (binary digits — 1s and 0s). The dots are simply convenient visual separators.

Zeros are often used as placeholders in dotted decimal notation; 189.21.241.56 can therefore also appear as 189.021.241.056.

IP networks are divided into three classes on the basis of size. A full IP address contains a network portion and a “host” (device) portion. The network and host portions of the address are different lengths for different classes of networks, as shown in the table below.

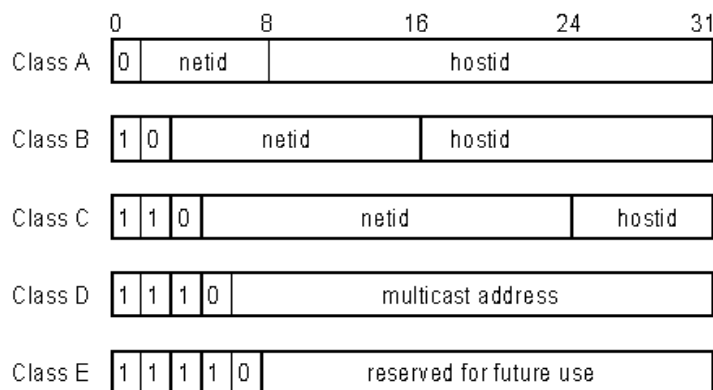

Networks attached to the Internet are assigned class types that determine the maximum number of possible hosts per network. The previous figure illustrates how the net and host portions of the IP address differ among the three classes. Class A is assigned to networks that have more than 65,535 hosts; Class B is for networks that have 256 to 65534 hosts; Class C is for networks with less than 256 hosts.

IP Network Classes			
Class	Maximum Number of Networks in Class	Network Addresses (Host Portion in Parenthesis)	Maximum Number of Hosts per Network
A	126	1(.0.0.0) to 126(.0.0.0)	16,777,214
B	16,382	128.1(.0.0) to 191.254(.0.0)	65,534
C	2,097,150	192.0.1(.0) to 223.255.254(.0)	254

Note: All network addresses outside of these ranges (Class D and E) are either reserved or set aside for experimental networks or multicasting.

When an IP address's host portion contains only zero(s), the address identifies a network and not a host. No physical device may be given such an address.

The network portion must start with a value from 1 to 126 or from 128 to 223. Any other value(s) in the network portion may be from 0 to 255, except that in class B the network addresses 128.0.0.0 and 191.255.0.0 are reserved, and in class C the network addresses 192.0.0.0 and 223.255.255.0 are reserved.

The value(s) in the host portion of a physical device's IP address can be in the range of 0 through 255 as long as this portion is not all-0 or all-255. Values outside the range of 0 to 255 can never appear in an IP address (0 to 255 is the full range of integer values that can be expressed with eight bits).

The network portion must be the same for all the IP devices on a discrete physical network (a single Ethernet LAN, for example, or a WAN link). The host portion must be different for each IP device — or, to be more precise, each IP-capable port or interface — connected directly to that network.

The network portion of an IP address will be referred to in this manual as a **network number**; the host portion will be referred to as a **host number**.

To connect to the Internet or to any private IP network that uses an Internet-assigned network number, you must obtain a registered IP network number from an Internet-authorized network information center. In many countries you must apply through a government agency, however they can usually be obtained from your Internet Service Provider (ISP).

If your organization's networks are, and will always remain, a closed system with no connection to the Internet or to any other IP network, you can choose your own network numbers as long as they conform to the above rules.

If your networks are isolated from the Internet, e.g. only between your two branch offices, you can assign any IP Addresses to hosts without problems. However, the Internet Assigned Numbers Authority (IANA) has reserved the following three blocks of IP Addresses specifically for private (stub) networks:

Class	Beginning Address	Ending Address
A	10.0.0.0	10.255.255.255
B	172.16.0.0	172.31.255.255
C	192.168.0.0	192.168.255.255

It is recommended that you choose private network IP Addresses from the above list. For more information on address assignment, refer to RFC 1597, *Address Allocation for Private Internets* and RFC 1466, *Guidelines for Management of IP Address Space*.

Subnet Mask

In the absence of subnetworks, specifying subnet masks as shown below may use standard TCP/IP addressing.

IP Class	Subnet Mask
Class A	255.0.0.0
Class B	255.255.0.0
Class C	255.255.255.0

Subnet mask settings other than those listed above add significance to the interpretation of bits in the IP address. The bits of the subnet mask correspond directly to the bits of the IP address. Any bit in a subnet mask that is to correspond to a net ID bit in the IP address must be set to 1.



DSL-500 Firmware Upgrade Utility

You can update system firmware using the DSL-500 Firmware Upgrade Utility. To upgrade the Router's firmware you must have installed this software on the PC you wish to use for this purpose. Install the utility by clicking the file titled **setup.exe** located on the Installation CD-ROM. It will be installed automatically. It is recommended that the PC be directly connected to the Router using a crossed cable, however you may upgrade it through the LAN from a remote host.

You also need to download the latest firmware version file from the D-Link web site to the PC on which you will use the Upgrade Utility. Instructions for downloading the firmware are located on the D-Link web site at www.dlink.com.

To launch the DSL-500 Firmware Upgrade Utility, click on the icon. Allow a few moments for the software to discover the Router on the network. After the discovery phase the following window will appear. You will see all the DSL-500 Routers on your network. You can identify individual devices by either its IP address or its MAC address. Select the device you wish to upgrade by double clicking on it.

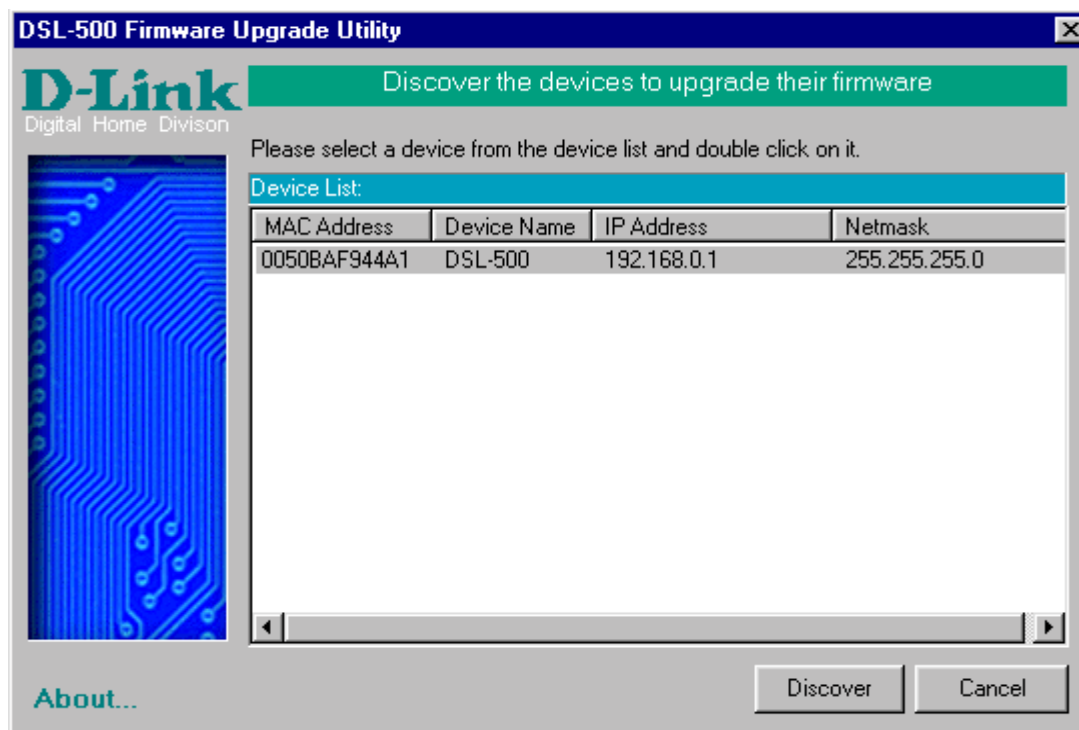

When you select a Router to upgrade you will be prompted for a password. The default password is **Admin**. If you want to change the password, you can change it using the console manager interface as described in Chapter 5.

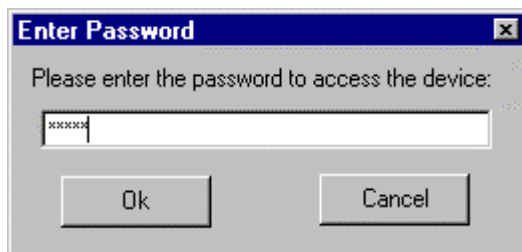

Enter the password and click OK.

In the new window you will see the MAC address of the Router and the IP address of the PC you are using. The PC and the Router must be on the same subnet for the upgrade to be completed. The upgrade utility will suggest a new IP address to be temporarily assigned to the device during the firmware upgrade procedure. Check the suggested IP address listed for the Router to be sure that it does not conflict with any existing IP addresses on your network. To change the temporary IP address of the Router, type in an available IP address in the space provided. You should change only the host portion of the address.

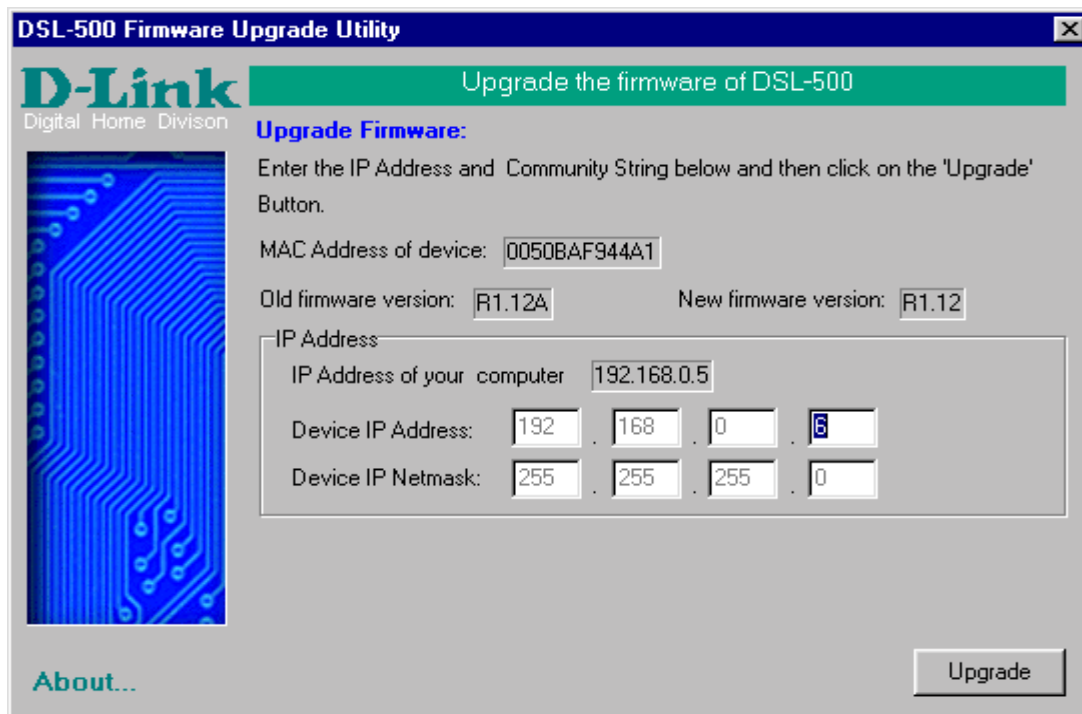

To upload the new firmware to the selected Router, click the 'Upgrade' button. The utility will automatically load the new firmware. During the upgrade process it is important that you allow the entire file to load onto the device. Do not turn

off the Router while the flash memory is being updated. A warning will appear during the upgrade reminding you not to power off the device.

When the new firmware has been successfully loaded a new window will inform you of the upgrade and tell you that the Router has been restarted. Click OK to proceed.

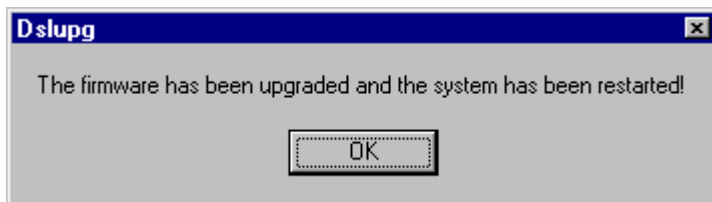

Wichtige Sicherheitshinweise

1. Bitte lesen Sie sich diese Hinweise sorgfältig durch.
2. Heben Sie diese Anleitung für den spätern Gebrauch auf.
3. Vor jedem Reinigen ist das Gerät vom Stromnetz zu trennen. Verwenden Sie keine Flüssig- oder Aerosolreiniger. Am besten dient ein angefeuchtetes Tuch zur Reinigung.
4. Um eine Beschädigung des Gerätes zu vermeiden sollten Sie nur Zubehörteile verwenden, die vom Hersteller zugelassen sind.
5. Das Gerät is vor Feuchtigkeit zu schützen.
6. Bei der Aufstellung des Gerätes ist auf sichern Stand zu achten. Ein Kippen oder Fallen könnte Verletzungen hervorrufen. Verwenden Sie nur sichere Standorte und beachten Sie die Aufstellhinweise des Herstellers.
7. Die Belüftungsöffnungen dienen zur Luftzirkulation die das Gerät vor Überhitzung schützt. Sorgen Sie dafür, daß diese Öffnungen nicht abgedeckt werden.
8. Beachten Sie beim Anschluß an das Stromnetz die Anschlußwerte.
9. Die Netzanschlußsteckdose muß aus Gründen der elektrischen Sicherheit einen Schutzleiterkontakt haben.
10. Verlegen Sie die Netzanschlußleitung so, daß niemand darüber fallen kann. Es sollte auch nichts auf der Leitung abgestellt werden.
11. Alle Hinweise und Warnungen die sich am Geräten befinden sind zu beachten.
12. Wird das Gerät über einen längeren Zeitraum nicht benutzt, sollten Sie es vom Stromnetz trennen. Somit wird im Falle einer Überspannung eine Beschädigung vermieden.
13. Durch die Lüftungsöffnungen dürfen niemals Gegenstände oder Flüssigkeiten in das Gerät gelangen. Dies könnte einen Brand bzw. Elektrischen Schlag auslösen.
14. Öffnen Sie niemals das Gerät. Das Gerät darf aus Gründen der elektrischen Sicherheit nur von autorisiertem Servicepersonal geöffnet werden.
15. Wenn folgende Situationen auftreten ist das Gerät vom Stromnetz zu trennen und von einer qualifizierten Servicestelle zu überprüfen:
 - a – Netzkabel oder Netzstecker sint beschädigt.
 - b – Flüssigkeit ist in das Gerät eingedrungen.
 - c – Das Gerät war Feuchtigkeit ausgesetzt.
 - d – Wenn das Gerät nicht der Bedienungsanleitung entsprechend funktioniert oder Sie mit Hilfe dieser Anleitung keine Verbesserung erzielen.
 - e – Das Gerät ist gefallen und/oder das Gehäuse ist beschädigt.
 - f – Wenn das Gerät deutliche Anzeichen eines Defektes aufweist.
16. Bei Reparaturen dürfen nur Originalersatzteile bzw. den Originalteilen entsprechende Teile verwendet werden. Der Einsatz von ungeeigneten Ersatzteilen kann eine weitere Beschädigung hervorrufen.
17. Wenden Sie sich mit allen Fragen die Service und Reparatur betreffen an Ihren Servicepartner. Somit stellen Sie die Betriebssicherheit des Gerätes sicher.
18. Zum Netzanschluß dieses Gerätes ist eine geprüfte Leitung zu verwenden, Für einen Nennstrom bis 6A und einem Gerätegewicht größer 3kg ist eine Leitung nicht leichter als H05VV-F, 3G, 0.75mm² einzusetzen

Limited Warranty

Hardware:

D-LINK WARRANTS EACH OF ITS HARDWARE PRODUCTS TO BE FREE FROM DEFECTS IN WORKMANSHIP AND MATERIALS UNDER NORMAL USE AND SERVICE FOR A PERIOD COMMENCING ON THE DATE OF PURCHASE FROM D-LINK OR ITS AUTHORIZED RESELLER AND EXTENDING FOR THE LENGTH OF TIME STIPULATED BY THE AUTHORIZED RESELLER OR D-LINK BRANCH OFFICE NEAREST TO THE PLACE OF PURCHASE.

THIS WARRANTY APPLIES ON THE CONDITION THAT THE PRODUCT REGISTRATION CARD IS FILLED OUT AND RETURNED TO A D-LINK OFFICE WITHIN NINETY (90) DAYS OF PURCHASE. A LIST OF D-LINK OFFICES IS PROVIDED AT THE BACK OF THIS MANUAL, TOGETHER WITH A COPY OF THE REGISTRATION CARD.

IF THE PRODUCT PROVES DEFECTIVE WITHIN THE APPLICABLE WARRANTY PERIOD, D-LINK WILL PROVIDE REPAIR OR REPLACEMENT OF THE PRODUCT. D-LINK SHALL HAVE THE SOLE DISCRETION WHETHER TO REPAIR OR REPLACE, AND REPLACEMENT PRODUCT MAY BE NEW OR RECONDITIONED. REPLACEMENT PRODUCT SHALL BE OF EQUIVALENT OR BETTER SPECIFICATIONS, RELATIVE TO THE DEFECTIVE PRODUCT, BUT NEED NOT BE IDENTICAL. ANY PRODUCT OR PART REPAIRED BY D-LINK PURSUANT TO THIS WARRANTY SHALL HAVE A WARRANTY PERIOD OF NOT LESS THAN 90 DAYS, FROM DATE OF SUCH REPAIR, IRRESPECTIVE OF ANY EARLIER EXPIRATION OF ORIGINAL WARRANTY PERIOD. WHEN D-LINK PROVIDES REPLACEMENT, THEN THE DEFECTIVE PRODUCT BECOMES THE PROPERTY OF D-LINK.

WARRANTY SERVICE MAY BE OBTAINED BY CONTACTING A D-LINK OFFICE WITHIN THE APPLICABLE WARRANTY PERIOD, AND REQUESTING A RETURN MATERIAL AUTHORIZATION (RMA) NUMBER. IF A REGISTRATION CARD FOR THE PRODUCT IN QUESTION HAS NOT BEEN RETURNED TO D-LINK, THEN A PROOF OF PURCHASE (SUCH AS A COPY OF THE DATED PURCHASE INVOICE) MUST BE PROVIDED. IF PURCHASER'S CIRCUMSTANCES REQUIRE SPECIAL HANDLING OF WARRANTY CORRECTION, THEN AT THE TIME OF REQUESTING RMA NUMBER, PURCHASER MAY ALSO PROPOSE SPECIAL PROCEDURE AS MAY BE SUITABLE TO THE CASE.

AFTER AN RMA NUMBER IS ISSUED, THE DEFECTIVE PRODUCT MUST BE PACKAGED SECURELY IN THE ORIGINAL OR OTHER SUITABLE SHIPPING PACKAGE TO ENSURE THAT IT WILL NOT BE DAMAGED IN TRANSIT, AND THE RMA NUMBER MUST BE PROMINENTLY MARKED ON THE OUTSIDE OF THE PACKAGE. THE PACKAGE MUST BE MAILED OR OTHERWISE SHIPPED TO D-LINK WITH ALL COSTS OF MAILING/SHIPPING/INSURANCE PREPAID. D-LINK SHALL NEVER BE RESPONSIBLE FOR ANY SOFTWARE, FIRMWARE, INFORMATION, OR MEMORY DATA OF PURCHASER CONTAINED IN, STORED ON, OR INTEGRATED WITH ANY PRODUCT RETURNED TO D-LINK PURSUANT TO THIS WARRANTY.

ANY PACKAGE RETURNED TO D-LINK WITHOUT AN RMA NUMBER WILL BE REJECTED AND SHIPPED BACK TO PURCHASER AT PURCHASER'S EXPENSE, AND D-LINK RESERVES THE RIGHT IN SUCH A CASE TO LEVY A REASONABLE HANDLING CHARGE IN ADDITION MAILING OR SHIPPING COSTS.

Software:

WARRANTY SERVICE FOR SOFTWARE PRODUCTS MAY BE OBTAINED BY CONTACTING A D-LINK OFFICE WITHIN THE APPLICABLE WARRANTY PERIOD. A LIST OF D-LINK OFFICES IS PROVIDED AT THE BACK OF THIS MANUAL, TOGETHER WITH A COPY OF THE REGISTRATION CARD. IF A REGISTRATION CARD FOR THE PRODUCT IN QUESTION HAS NOT BEEN RETURNED TO A D-LINK OFFICE, THEN A PROOF OF PURCHASE (SUCH AS A COPY OF THE DATED PURCHASE INVOICE) MUST BE PROVIDED WHEN REQUESTING WARRANTY SERVICE. THE TERM "PURCHASE" IN THIS SOFTWARE WARRANTY REFERS TO THE PURCHASE TRANSACTION AND RESULTING LICENSE TO USE SUCH SOFTWARE.

D-LINK WARRANTS THAT ITS SOFTWARE PRODUCTS WILL PERFORM IN SUBSTANTIAL CONFORMANCE WITH THE APPLICABLE PRODUCT DOCUMENTATION PROVIDED BY D-LINK WITH SUCH SOFTWARE PRODUCT, FOR A PERIOD OF NINETY (90) DAYS FROM THE DATE OF PURCHASE FROM D-LINK OR ITS AUTHORIZED RESELLER. D-LINK WARRANTS THE MAGNETIC MEDIA, ON WHICH D-LINK PROVIDES ITS SOFTWARE PRODUCT, AGAINST FAILURE DURING THE SAME WARRANTY PERIOD. THIS WARRANTY APPLIES TO PURCHASED SOFTWARE, AND TO REPLACEMENT SOFTWARE PROVIDED BY D-LINK PURSUANT TO THIS WARRANTY, BUT SHALL NOT APPLY TO ANY UPDATE OR REPLACEMENT WHICH MAY BE PROVIDED FOR DOWNLOAD VIA THE INTERNET, OR TO ANY UPDATE WHICH MAY OTHERWISE BE PROVIDED FREE OF CHARGE.

D-LINK'S SOLE OBLIGATION UNDER THIS SOFTWARE WARRANTY SHALL BE TO REPLACE ANY DEFECTIVE SOFTWARE PRODUCT WITH PRODUCT WHICH SUBSTANTIALLY CONFORMS TO D-LINK'S APPLICABLE PRODUCT DOCUMENTATION. PURCHASER ASSUMES RESPONSIBILITY FOR THE SELECTION OF APPROPRIATE APPLICATION AND SYSTEM/PLATFORM SOFTWARE AND ASSOCIATED REFERENCE MATERIALS. D-LINK MAKES NO WARRANTY THAT ITS SOFTWARE PRODUCTS WILL WORK IN COMBINATION WITH ANY HARDWARE, OR ANY APPLICATION OR SYSTEM/PLATFORM SOFTWARE PRODUCT PROVIDED BY ANY THIRD PARTY, EXCEPTING ONLY SUCH PRODUCTS AS ARE EXPRESSLY REPRESENTED, IN D-LINK'S APPLICABLE PRODUCT DOCUMENTATION AS BEING COMPATIBLE. D-LINK'S OBLIGATION UNDER THIS WARRANTY SHALL BE A REASONABLE EFFORT TO PROVIDE COMPATIBILITY, BUT D-LINK SHALL HAVE NO OBLIGATION TO PROVIDE COMPATIBILITY WHEN THERE IS FAULT IN THE THIRD-PARTY HARDWARE OR SOFTWARE. D-LINK MAKES NO WARRANTY THAT OPERATION OF ITS SOFTWARE PRODUCTS WILL BE UNINTERRUPTED OR ABSOLUTELY ERROR-FREE, AND NO WARRANTY THAT ALL DEFECTS IN THE SOFTWARE PRODUCT, WITHIN OR WITHOUT THE SCOPE OF D-LINK'S APPLICABLE PRODUCT DOCUMENTATION, WILL BE CORRECTED.

D-Link Offices for Registration and Warranty Service

THE PRODUCT'S REGISTRATION CARD, PROVIDED AT THE BACK OF THIS MANUAL, MUST BE SENT TO A D-LINK OFFICE. TO OBTAIN AN RMA NUMBER FOR WARRANTY SERVICE AS TO A HARDWARE PRODUCT, OR TO OBTAIN WARRANTY SERVICE AS TO A SOFTWARE PRODUCT, CONTACT THE D-LINK OFFICE NEAREST YOU. AN ADDRESS/TELEPHONE/FAX/E-MAIL/WEB SITE LIST OF D-LINK OFFICES IS PROVIDED IN THE BACK OF THIS MANUAL.

LIMITATION OF WARRANTIES

IF THE D-LINK PRODUCT DOES NOT OPERATE AS WARRANTED ABOVE, THE CUSTOMER'S SOLE REMEDY SHALL BE, AT D-LINK'S OPTION, REPAIR OR REPLACEMENT. THE FOREGOING WARRANTIES AND REMEDIES ARE EXCLUSIVE AND ARE IN LIEU OF ALL OTHER WARRANTIES, EXPRESSED OR IMPLIED, EITHER IN FACT OR BY OPERATION OF LAW, STATUTORY OR OTHERWISE, INCLUDING WARRANTIES OF MERCHANTABILITY AND FITNESS FOR A PARTICULAR PURPOSE. D-LINK NEITHER ASSUMES NOR AUTHORIZES ANY OTHER PERSON TO ASSUME FOR IT ANY OTHER LIABILITY IN CONNECTION WITH THE SALE, INSTALLATION MAINTENANCE OR USE OF D-LINK'S PRODUCTS. D-LINK SHALL NOT BE LIABLE UNDER THIS WARRANTY IF ITS TESTING AND EXAMINATION DISCLOSE THAT THE ALLEGED DEFECT IN THE PRODUCT DOES NOT EXIST OR WAS CAUSED BY THE CUSTOMER'S OR ANY THIRD PERSON'S MISUSE, NEGLIGENCE, IMPROPER INSTALLATION OR TESTING, UNAUTHORIZED ATTEMPTS TO REPAIR, OR ANY OTHER CAUSE BEYOND THE RANGE OF THE INTENDED USE, OR BY ACCIDENT, FIRE, LIGHTNING OR OTHER HAZARD.

LIMITATION OF LIABILITY

IN NO EVENT WILL D-LINK BE LIABLE FOR ANY DAMAGES, INCLUDING LOSS OF DATA, LOSS OF PROFITS, COST OF COVER OR OTHER INCIDENTAL, CONSEQUENTIAL OR INDIRECT DAMAGES ARISING OUT THE INSTALLATION, MAINTENANCE, USE, PERFORMANCE, FAILURE OR INTERRUPTION OF A D-LINK PRODUCT, HOWEVER CAUSED AND ON ANY THEORY OF LIABILITY. THIS LIMITATION WILL APPLY EVEN IF D-LINK HAS BEEN ADVISED OF THE POSSIBILITY OF SUCH DAMAGE.

IF YOU PURCHASED A D-LINK PRODUCT IN THE UNITED STATES, SOME STATES DO NOT ALLOW THE LIMITATION OR EXCLUSION OF LIABILITY FOR INCIDENTAL OR CONSEQUENTIAL DAMAGES, SO THE ABOVE LIMITATION MAY NOT APPLY TO YOU.

Trademarks

Copyright ©2000 D-Link Corporation.

Contents subject to change without prior notice.

D-Link is a registered trademark of D-Link Corporation/D-Link Systems, Inc.

All other trademarks belong to their respective proprietors.

Copyright Statement

No part of this publication may be reproduced in any form or by any means or used to make any derivative such as translation, transformation, or adaptation without permission from D-Link Corporation/D-Link Systems Inc., as stipulated by the United States Copyright Act of 1976

FCC Warning

This device complies with part 15 of the FCC Rules. Operation is subject to the following two conditions: (1) This device may not cause harmful interference, and (2) this device must accept any interference received, including interference that may cause undesired operation.

This equipment has been tested and found to comply with the limits for a Class B digital device, pursuant to part 15 of the FCC Rules. These limits are designed to provide reasonable protection against harmful interference in a residential installation. This generates, uses and can radiate radio frequency energy and, if not installed and used in accordance with the instructions, may cause harmful interference to radio communications. However, there is no guarantee that interference will not occur in a particular installation. If this equipment does cause harmful interference to radio or television reception, which can be determined by turning equipment off and on, the user is encouraged to try to correct the interference by one or more of the following measures:

- Reorient or relocate the receiving antenna.
- Increase the separation between the equipment and receiver.
- Connect the equipment into an outlet on a circuit different from that to which the receiver is connected.
- Consult the dealer or an experienced radio/TV technician for help.

CE Mark Warning

This is a Class B product. In a domestic environment, this product may cause radio interference in which case the user may be required to take adequate measures.

VCCI Class B Warning

この装置は、情報処理装置等電波障害自主規制協議会(VCCI)の基準に基づくクラスB 情報技術装置です。この装置は、家庭環境で使用することを目的としていますが、この装置がラジオやテレビジョン受信機に近接して使用されると、受信障害を引き起こすことがあります。

取扱説明書に従って正しい取り扱いをして下さい。

Registration Card

Print, type or use block letters.

Your name: Mr./Ms _____

Organization: _____ Dept. _____

Your title at organization: _____

Telephone: _____ Fax: _____

Organization's full address: _____

Country: _____

Date of purchase (Month/Day/Year): _____

Product Model	Product Serial No.	* Product installed in type of computer (e.g., Compaq 486)	* Product installed in computer serial No.

(* Applies to adapters only)

Product was purchased from:

Reseller's name: _____

Telephone: _____ Fax: _____

Reseller's full address: _____

Answers to the following questions help us to support your product:

1. Where and how will the product primarily be used?

Home Office Travel Company Business Home Business Personal Use

2. How many employees work at installation site?

1 employee 2-9 10-49 50-99 100-499 500-999 1000 or more

3. What network protocol(s) does your organization use ?

XNS/IPX TCP/IP DECnet Others _____

4. What network operating system(s) does your organization use ?

D-Link LANsmart Novell NetWare NetWare Lite SCO Unix/Xenix PC NFS 3Com 3+Open

Banyan Vines DECnet Pathwork Windows NT Windows NTAS Windows '95

Others _____

5. What network management program does your organization use ?

D-View HP OpenView/Windows HP OpenView/Unix SunNet Manager Novell NMS

NetView 6000 Others _____

6. What network medium/media does your organization use ?

Fiber-optics Thick coax Ethernet Thin coax Ethernet 10BASE-T UTP/STP

100BASE-TX 100BASE-T4 100VGAnyLAN Others _____

7. What applications are used on your network?

Desktop publishing Spreadsheet Word processing CAD/CAM

Database management Accounting Others _____

8. What category best describes your company?

Aerospace Engineering Education Finance Hospital Legal Insurance/Real Estate Manufacturing

Retail/Chainstore/Wholesale Government Transportation/Utilities/Communication VAR

System house/company Other _____

9. Would you recommend your D-Link product to a friend?

Yes No Don't know yet

10. Your comments on this product? _____

PLEASE
PLACE STAMP
HERE

TO:

D-Link®