

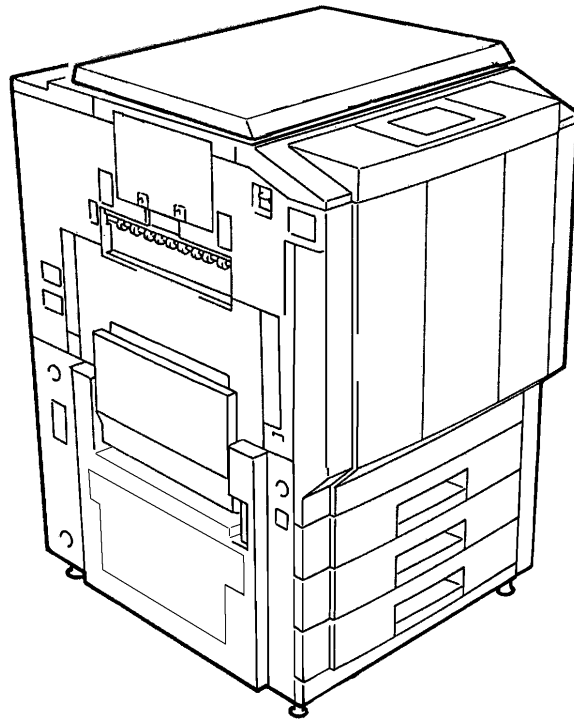

CF 911 P

Operator's Manual



Using the Printer Properly

To ensure the optimum performance of the printer, follow the precautions listed below.

- Never place a heavy object on the printer.
- Never subject the printer to shocks.
- Never open any doors or turn the printer off while the printer is making printings.
- Never bring any magnetized object near the printer.
- Never use flammable sprays, liquids or gases near the printer.
- Never modify the printer, as a fire or electrical shock could result.
- Never remove any panel or cover which is secured. The printer contains high voltage components which can cause electrical shock.
- Never tamper with the laser mechanism on laser-equipped models, as blindness or other injury may result.
- Never drop paper clips, staples or other small pieces of metal through the vents or other openings in the printer, as a fire or electrical shock can result.
- Never place containers of liquid on the printer. If liquids get inside the printer, they can cause fire or electrical shock. If a piece of metal or any liquid gets inside the printer, immediately turn the printer off, unplug the power cord and call your technical representative. A fire or electrical shock can result if the printer remains plugged in or is operated after metal or liquid gets inside.
- Never leave the printer running if it becomes unusually hot, or if smoke or an unusual odor or noise is detected. Should any of these conditions occur, immediately turn the printer off, unplug the power cord and call your technical representative. A fire or electrical shock can result if the printer remains plugged in under any of these conditions.
- Always insert the power plug all the way into the outlet.
- Always make sure that the outlet is visible, clear of the printer or printer cabinet.
- Always provide good ventilation when making a large number of continuous printings.
- Never pull on the power cord, and always hold the plug when unplugging the power cord. A damaged cord could result in a fire or cause an electrical shock.
- Never unplug the power cord with a wet hand, as it could cause an electrical shock.
- Always unplug the power cord before moving the printer. Moving the printer with the power cord plugged in can damage the cord resulting in a fire or causing an electrical shock.
- Always unplug the power cord when the printer is not going to be used for a long time.
- Never place a heavy object on the power cord, or pull or bend it, as a fire or electrical shock can result.
- Always ensure that the printer does not sit on or move onto the power cord or communications cable of other electrical equipment, as malfunctioning equipment or a fire could result.
- Always ensure that the power cord or communications cable of other electrical equipment does not become wedged into the printer mechanism, as malfunctioning equipment or a fire could result.

Using the Printer Properly

- Always use the correct power voltage, as improper voltage can cause a fire or electrical shock.
- Never use a multiple outlet adapter, as a fire or electrical shock can result.
- Should the power cord become damaged, immediately turn the printer off, unplug the power cord and call your technical representative. A damaged cord can result in a fire or cause an electric shock.
- If an extension cord is needed, use one with a greater rated capacity than the maximum power requirements of the printer. The use of an extension cord that falls short of supporting the maximum power requirements can result in overheating or a fire.
- Always unplug the printer whenever anything unusual is observed during operation. Make sure that the outlet is nearby and clear of the printer and furniture.

NOTE

= *Locate the Printer in a Well Ventilated Room* =

A negligible amount of ozone is generated during normal operation of this unit. An unpleasant odor may, however, be created in poorly ventilated rooms during extensive unit operation. For a comfortable, healthy, and safe operating environment, it is recommended that the room be well ventilated.

REMARQUE

= *Placer le l'appareil dans une pièce largement ventilée* =

Une quantité d'ozone négligeable est dégagée pendant le fonctionnement de l'appareil quand celui-ci est utilisé normalement. Cependant, une odeur désagréable peut être ressentie dans les pièces dont l'aération est insuffisante et lorsque une utilisation prolongée de l'appareil est effectuée. Pour avoir la certitude de travailler dans un environnement réunissant des conditions de confort, santé et de sécurité, il est préférable de bien aérer la pièce ou se trouve le l'appareil.

Safety Information

SAFETY INFORMATION

This color printer is a digital printer which operates by means of a laser. There is no possibility of danger from the laser, provided the printer is operated according to the instructions in this manual.

Since radiation emitted by the laser is completely confined within protective housing, the laser beam cannot escape from the machine during any phase of user operation.

This machine is certified as a Class 1 laser product. This means the printer does not product hazardous laser radiation.

LUOKAN 1 LASERLAITE KLASS 1 LASER APPARAT
--

CAUTION

The use of controls, adjustments or performance of procedures other than those specified in this manual may result in hazardous radiation exposure. Because of this, we strongly recommend that you operate your printer only as described in this documentation.

For United States Users:

This printer is certified as a Class 1 Laser product under Radiation Performance Standard according to the Food, Drug and Cosmetic Act of 1990. Compliance is mandatory for Laser products marketed in the United States and is reported to the Center for Devices and Radiological Health (CDRH) of the U.S. Food and Drug Administration of the U.S. Department of Health and Human Services (DHHS). This means that the FAX does not produce hazardous laser radiation.

The label shown below indicates compliance with the CDRH regulations and must be attached to laser products marketed in the United States.

WARNING

Use of controls, adjustments or performance of procedures other than those specified in this manual may result in hazardous radiation exposure.

[Internal Laser Radiation]

Maximum Radiation Power:	26.79 μ W
Wave Length:	780nm

Safety Information

For European Users:

WARNING

Use of controls, adjustments or performance of procedures other than those specified in this manual may result in hazardous radiation exposure.

This is a semiconductor laser. The maximum power of the laser diode is 26.79 μ W and the wavelength is 780nm.

For Denmark Users:

ADVARSEL

*Usynlig laserstråling ved åbning, når sikkerhedsafbrydere er ude af funktion.
Undgå udsættelse for stråling.*

Klasse 1 laser produkt der opfylder IEC825 sikkerheds kravene.

For Finland, Sweden Users:

VAROITUS

Laitteen Käyttäminen muulla kuin tässä käyttöohjeessa mainitulla tavalla saattaa altistaa käyttäjän turvallisuusluokan 1 ylittävälle näkymättömälle lasersäteilylle.

WARNING

Om apparaten används på annat sätt än i denna bruksanvisning specificerats, kan användaren utsättas för osynlig laserstråling, som överskrider gränsen för laser klass 1.

For Norway Users:

ADVERSEL

Dersom apparatet brukes på annen måte enn spesifisert i denne bruksanvisning, kan brukeren utsettes for usynlig laserstråling som overskrider grensen for laser klasse 1.

Dette en halvleder laser. Maksimal effekt till laserdiode er 26.79 μ W og bølgelengde er 780nm.

Laser Safety Labels

[Label on printer surface]

A laser safety label is attached to the outside of the printer as shown below.

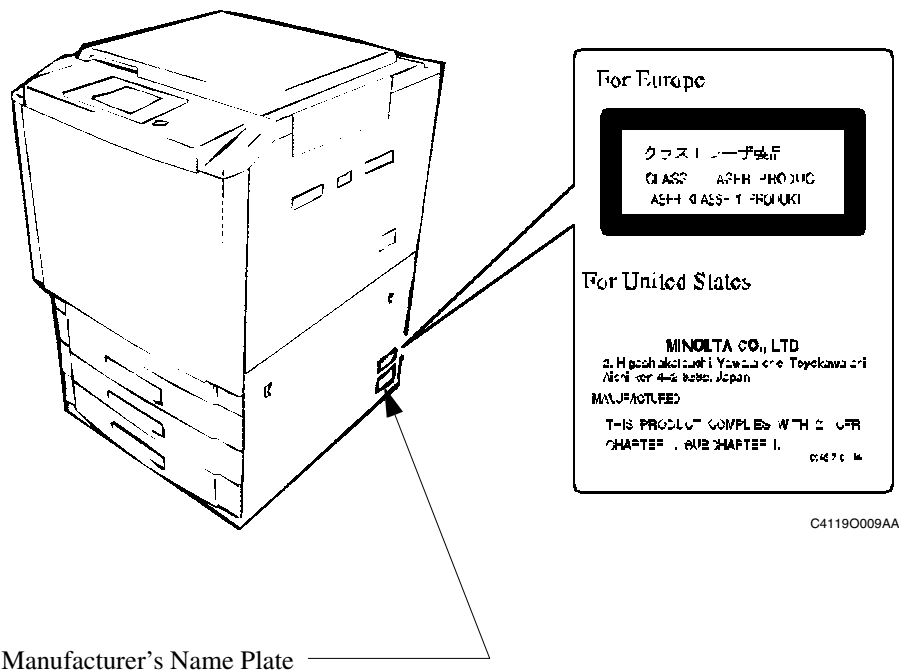

The Manufacturer's Name Plate is affixed at the position illustrated above.
Please write down the Model Name and Serial No. of your printer here, if necessary.

Model:
Serial No.:

Regulatory Information

WARNING

This equipment has been tested and found to comply with the limits for a Class A digital device, pursuant to Part 15 of the FCC Rules. These limits are designed to provide reasonable protection against harmful interference when the equipment is operated in a commercial environment. This equipment generates, uses, and can radiate radio frequency energy and if not installed and used in accordance with the instruction manual, may cause harmful interference to radio communications. Operation of this equipment in a residential area is likely to cause harmful interference in which case the user will be required to correct the interference at his own expense.

The design and production of this unit conforms to FCC Regulations, and any changes or modifications must be registered with the FCC and are subject to FCC control. Any changes made by the purchaser or user without first contacting the manufacturer will be subject to penalty under FCC regulations.

FCC-F01

This Class A digital apparatus complies with Canadian ICES-003.
Cet appareil numérique de la classe A est conforme à la norme NMB-003 du Canada.

IC-F03

Thank you for choosing Minolta.

This operator's manual explains how to operate the color printer and replenish its supplies. It also gives some troubleshooting tips as well as general precautions to be observed when operating the color printer.

To ensure the best performance and effective use of your color printer, read this manual carefully until you familiarize yourself thoroughly with its operation and features. After you have read through the manual, keep it for ready reference.

Please use this manual as a quick and handy reference tool for immediately clarifying any questions which may arise.

CE Marking (Declaration of Conformity)

We declare under our sole responsibility that the color printer and options to which this declaration relates is in conformity with the specifications below.

This declaration is valid for the area of the European Union (EU) only.

Product Type	Digital Full Color Printing Machine
Product Name	CF911P
Options	ST-103, S-105, C-101, AD-7, DT-104
Standards	<p>Safety ^{*2} : EN 60 950 / 1992 (A1:1993, A2:1993, A3:1995, A4:1997) (Safety of information technology equipment, including electrical business equipment) EN 60825 / 1992 (A11:1996) (Radiation safety of laser products, equipment classification, requirements and user's guide)</p> <p>EMC ^{*1} : EN 55 022 (Class B) / 1994 (A2 : 1997) (Limits and method for measurement of radio disturbance characteristics of information technology equipment (ITE)) EN 50 082-1 / 1992 (Electromagnetic compatibility - Generic immunity standard Part 1: Residential, commercial and light industry) IEC 801-2 / 1991 (Electrostatic discharge requirement) IEC 801-3 / 1984 (Radiated electromagnetic field requirement) IEC 801-4 / 1988 (Electrical fast transient / burst requirement)</p> <p>Note : *1) EMC performance: This product was designed for operation in a typical office environment. *2) First year of labeling according to EC-directive 73/23/EEC and 93/68/EEC: 98</p>
EC Directives	<p>Safety : 73 / 23 / EEC and 93 / 68 / EEC EMC : 89 / 336 / EEC and 93 / 68 / EEC</p>

Technical Support

Thank you for choosing Minolta quality. For over 30 years Minolta has been a leader on the forefront of office equipment technology and service. Our desire has always been to bring you highly reliable products. We pledge to continue to provide you, our customer, with our state of the art equipment, as well as full customer service for all our products. We look forward to a long healthy relationship with you and our company. If you have any questions or comments about Minolta, our product or service, please let us know. Our fax number is 800-237-8087 (for U.S.A. and Canada). Thank you again.

This operator's manual explains how to operate the color printer and replenish its supplies. It also gives some troubleshooting tips as well as general precautions to be observed when operating the color printer.

To ensure the best performance and effective use of your color printer, read this manual carefully until you familiarize yourself thoroughly with the it's operation and features. After you have read through the manual, keep it ready for reference.

Please use this manual as a quick and handy reference tool for immediately clarifying any questions which may arise.

Terms and Symbols for the Type of Printer Paper

A few special terms and symbols are used in this manual to designate the types of printer paper.

Feeding Direction (printer paper path)

In this system, printer paper is taken up from the left-hand side of the unit and fed through the unit toward the right-hand side, face-down onto the Exit Tray. In the figure below, the direction in which the printer paper is fed, as indicated by the arrow, is called the “feeding direction”.

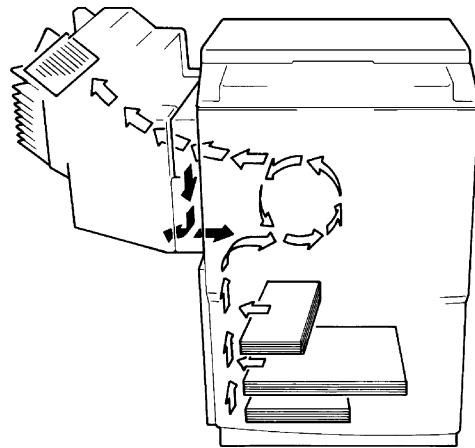

C4119O002AA

“Width” and “Length”

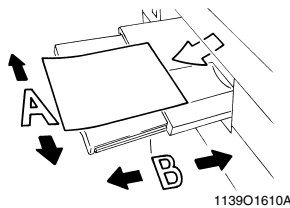

1139O1610A

When the size of the print is described, side A is referred to as the “width” and side B as the “length”.

A: Width
B: Length

Terms and Symbols

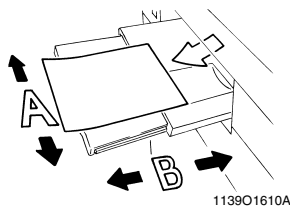

1139O1610A

<Lengthwise  >

When the original or print has a “length” longer than its “width,” we call it “lengthwise” and use symbol “L” or “.

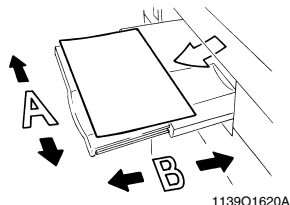

1139O1620A

<Crosswise  >

When the original or print has a “length” shorter than its “width,” we call it “crosswise” and use symbol “C” or “.

x
Contents

Organization

Chapters 1 through 3 contain the basic information for making prints.
 Be sure to read these chapters before attempting to use your printer.

	Using the Printer Properly	i
	Safety Information	iii
	Regulatory Information.....	vi
	Technical Support	viii
	Terms and Symbols for the Type of Printer Paper.....	ix
Chapter 1	Safety Notes	1-1
	1. Installing the Printer	1-2
	Installation Site	1-2
	Power Source	1-2
	Space Requirements.....	1-2
	2. Precautions for Use	1-3
	Operating Environment.....	1-3
	Using the Unit Properly	1-3
	Moving.....	1-3
	Care of Printer Supplies	1-3
	Storage of Prints.....	1-4
Chapter 2	Getting to Know Your Printer.....	2-1
	1. System Overview	2-2
	System Overview	2-2
	2. Printer Parts and Accessories	2-3
	3. Operation Panel	2-6
	Operation Panel Names and Functions	2-6
	4. Computer Connection	2-7
	5. Turning ON and OFF	2-8
	Turning ON and OFF.....	2-8
	When the unit is turned ON	2-8
	Continuous Printing Precautions.....	2-9
Chapter 3	Printing Procedures.....	3-1
	1. Printing	3-2
	Printing Preparations.....	3-2
	Performing Printing.....	3-2
	2. Function Settings	3-3
	Application Specification.....	3-3
	Printer Driver Specification	3-3

Chapter 4	Setup Menu Settings	4-1
	1. Setup Menu Summary	4-2
	Possible Setting Items in the Setup Menu	4-2
	Setup Menu Hierarchy	4-3
	Setup Menu Keys	4-3
	2. Setup Menu Procedures	4-4
	Starting the Setup Menu	4-4
	Operating the Setup Menu	4-5
	3. Server Setup Menu	4-8
	Server Setup Menu Hierarchy	4-8
	Server Setup Menu Setting Items	4-8
	Server Setup Menu Setting Item Details	4-8
	4. Setup Menu Transition Diagram	4-11
Chapter 5	Function Menu Settings	5-1
	1. Function Menu Summary	5-2
	Function Menu Setting Items	5-2
	2. Function Menu Operation Procedures	5-3
	Starting the Function Menu	5-3
	Function Menu Keys	5-3
	Function Menu Operation	5-3
	3. Function Menu Transition Diagram	5-4
Chapter 6	When a Message Appears	6-1
	1. When the Message "LOAD IN ANY TRAY" is displayed.	6-2
	Paper Loading Procedures	6-2
	2. When the Message "TONER NEAR EMPTY" or "NO TONER" Appears	6-4
	Replenishing Toner	6-4
	3. When the Message "NO STAPLE" Appears	6-6
	Replacing the Staple Cartridge	6-6
	4. When "Misfeeding Occurs."	6-8
	Misfeed Location	6-8
	5. When the Message "The Fuser Oil Near Empty." Appears	6-14
	6. When the Message "Alert, Service code" is displayed.	6-14
	7. What Does Each Message Mean?	6-15
	What Does Each Message Mean?	6-15
Chapter 7	Troubleshooting	7-1
	1. When This Type of Print is Produced	7-2
	2. Printer Malfunctions	7-3
	The printer is malfunctioning	7-3
Chapter 8	Miscellaneous	8-1
	1. Specifications	8-2
	Specifications	8-2
	2. Care of the Unit	8-6
	Cleaning	8-6
	3. Paper Size Table	8-7
	4. Index	8-8
	Index	8-8

Chapter 1

Safety Notes

1. Installing the Printer

Installation Site

To ensure optimal safety and prevent possible malfunctions of the unit, install the printer in a location which meets the following requirements.

- ◆ A place away from a curtain or the like that may catch fire and burn easily.
- ◆ An area where there is no possibility of being splashed with water or other types of liquid.
- ◆ An area free from direct sunlight.
- ◆ A place out of the direct air stream of an air conditioner, heater, or ventilator.
- ◆ A well-ventilated place.
- ◆ A dry place.
- ◆ A dust-free location.
- ◆ An area not subject to undue vibration.
- ◆ A stable and level location.
- ◆ A place where ammonia or other organic gas is not generated.
- ◆ A place which does not put the operator in the direct stream of exhaust from the printer.
- ◆ A place which is not near any kind of heating device.

Power Source

The power source voltage requirements are as follows.

- ◆ Use a power source with little voltage fluctuation.
 - Voltage Fluctuation : Within $\pm 10\%$ (for U.S.A. and Canada)
 - Specified voltage $\pm 10\%$ (For EU)
- ◆ Frequency Fluctuation : Within $\pm 0.3\%$ (For U.S.A. and Canada)
- Specified frequency $\pm 3\text{Hz}$ (For EU)

Space Requirements

To ensure easy printer operation, supply replacement and service maintenance, observe the recommended space requirements detailed below.

- * Be sure to allow a clearance of 150 mm (6") or more at the back of the printer as there is a ventilation duct.

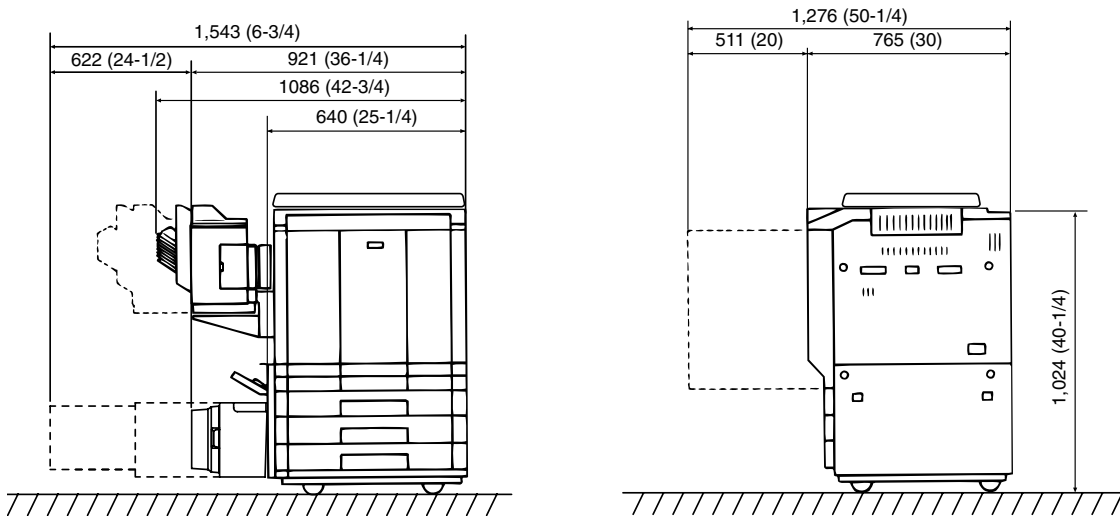

Scale: mm(inch)

C4119O003AA

2. Precautions for Use

Operating Environment

The operating environmental requirements of the printer are as follows.

Temperature : 10°C to 30°C (50°F to 86°F) with a fluctuation of 10°C (50°F) per hour.
 Humidity : 25% to 85% with a fluctuation of 20% per hour.

Using the Unit Properly

To ensure the optimum performance of the unit, follow the precautions listed below.

- ◆ NEVER place a heavy object on the unit or subject the unit to any shock.
- ◆ NEVER open any Doors, or turn OFF the unit while it is printing.
- ◆ NEVER bring any magnetized object or use flammable sprays near the unit.
- ◆ NEVER modify the unit as a fire or electrical shock could result.
- ◆ ALWAYS insert the Power Plug all the way into the outlet.
- ◆ ALWAYS make sure that the outlet is visible, clear of the unit or unit cabinet.
- ◆ ALWAYS provide good ventilation when producing a large number of continuous prints.

NOTE

= *Locate the Printer in a Well Ventilated Room* =

A negligible amount of ozone is generated during normal operation of this unit. An unpleasant odor may, however, be created in poorly ventilated rooms during extensive unit operation. For a comfortable, healthy, and safe operating environment, it is recommended that the room be well ventilated.

REMARQUE

= *Placer le l'appareil dans une pièce largement ventilée* =

Une quantité d'ozone négligeable est dégagée pendant le fonctionnement de l'appareil quand celui-ci est utilisé normalement. Cependant, une odeur désagréable peut être ressentie dans les pièces dont l'aération est insuffisante et lorsque une utilisation prolongée de l'appareil est effectuée. Pour avoir la certitude de travailler dans un environnement réunissant des conditions de confort, santé et de sécurité, il est préférable de bien aérer la pièce ou se trouve le l'appareil.

Moving

If you need to transport the unit over a long distance, consult your Technical Representative.

Care of Printer Supplies

Use the following precautions when handling the unit supplies (toner, paper, etc.).

- ◆ Store the paper, toner and other supplies in a location free from direct sunlight and separate from any heating apparatus. Keep these supplies in a dry, clean environment.
- ◆ Store paper which has been removed from its wrapper but not loaded into the Drawer, in a sealed plastic bag in a cool, dark place.
- ◆ Keep supplies out of the reach of children.
- ◆ If your hands become soiled with toner, wash them with soap and water immediately.

Storage of Prints

- If prints are to be kept for a long time, keep them in a place which is not exposed to light to prevent fading.
 - If an adhesive containing solvent (e.g., spray glue) is used to past printings, the toner on the prints can melt.
 - The color prints have a toner layer thicker than the normal black-and-white prints. When a color print is folded, therefore, the toner can be broken at the fold.
-

NOTE

This unit is equipped with a counterfeit prevention function that can cause slight noise in the printed image.

Useful Tip

By activating the “Print Track Functions” offered by this unit, only authorized users who enter their unique access number can use the printer. This function helps prevent dishonest use of the unit.

Chapter 2

Getting to Know Your Printer

1. System Overview

System Overview

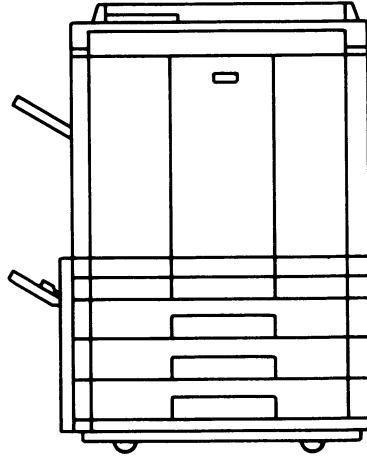

1144O003AB

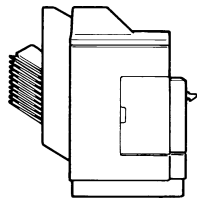

1139O0020A

Sorter S-105/Staple Sorter ST-103 <Option>

Permits automatic sorting or grouping of prints into 10 print sets or stacks. In addition, the Staple Sorter automatically staples the printed sets or stacks that are sorted or grouped.

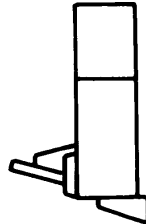

1144O184AA

Duplex Unit AD-7 <Option>

Automatically turns over one-sided prints to produce two-sided prints.

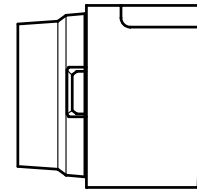

1154O028AA

Large Capacity Cassette C-101 <Option>

Holds up to 1,000 sheets of A4C (LetterC) print paper (80 g/m² or 21-1/4 lbs).

2. Printer Parts and Accessories

Outside the Unit

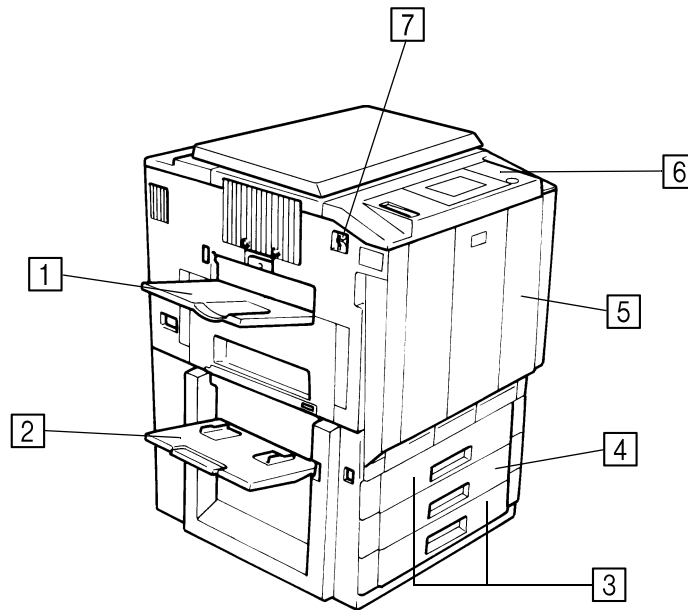

C41190004AA

- | | | |
|----------|---------------------------------|--|
| 1 | Exit Tray: | Holds the prints ejected from the unit. |
| 2 | Manual Bypass Tray: | Use for manual feeding of printer paper into the unit. |
| 3 | Upper/Lower Tray: | Holds up to 500 sheets of paper. See p. 6-2 |
| 4 | Middle Tray (Universal): | Holds up to 250 sheets of paper. See p. 6-2 |
| 5 | Front Door: | Open to clear a paper misfeed or add toner. See pp. 6-4, 6-9 |
| 6 | Operation Panel: | Use to verify the printer condition and perform the menu settings.
See Operation Panel Keys and Touch Panel. See p. 2-6 |
| 7 | Power Switch: | Use to turn the printer ON and OFF. See p. 2-8 |

Inside the Unit

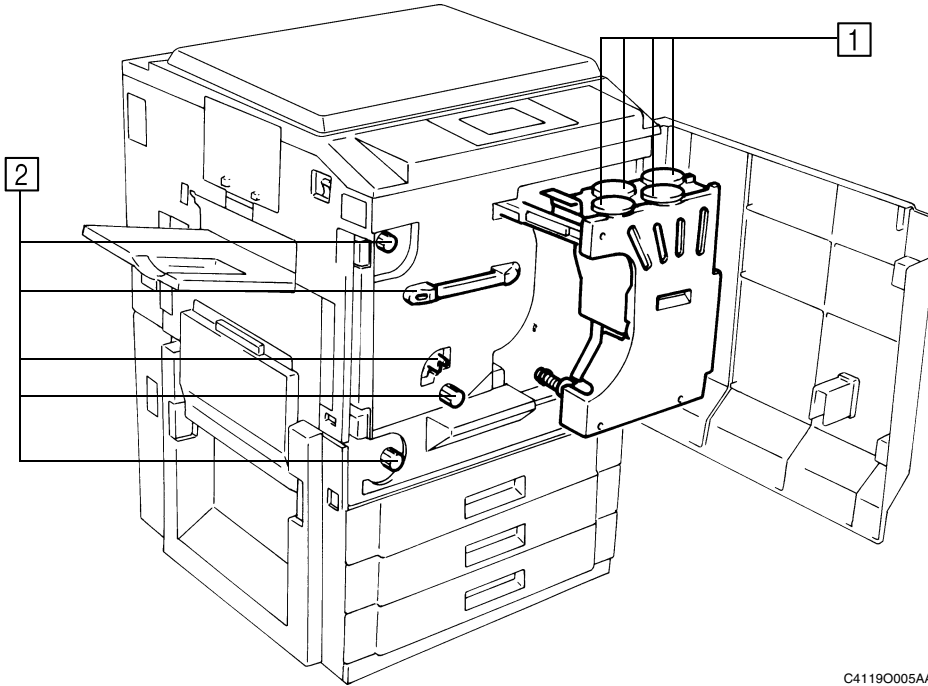

C4119O005AA

- 1 **Toner Hopper Lid:** Open when adding toner. ☞ p. 6-4
- 2 **(M1) ~ (M9):** Operate these parts to clear misfed sheets of paper. ☞ p. 6-8

Connector Layout

- 1 **IEEE1284:** This is connected to the printer port of the computer by a parallel interface cable.
- 2 **Ethernet (10/100 Base-T):** This is connected to the computer through the network and corresponds to 10/100 Base-T.

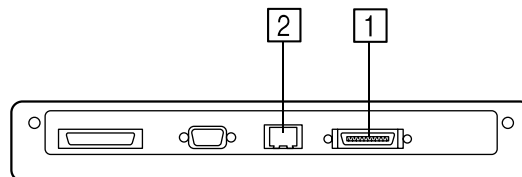

C4119O024AA

Options

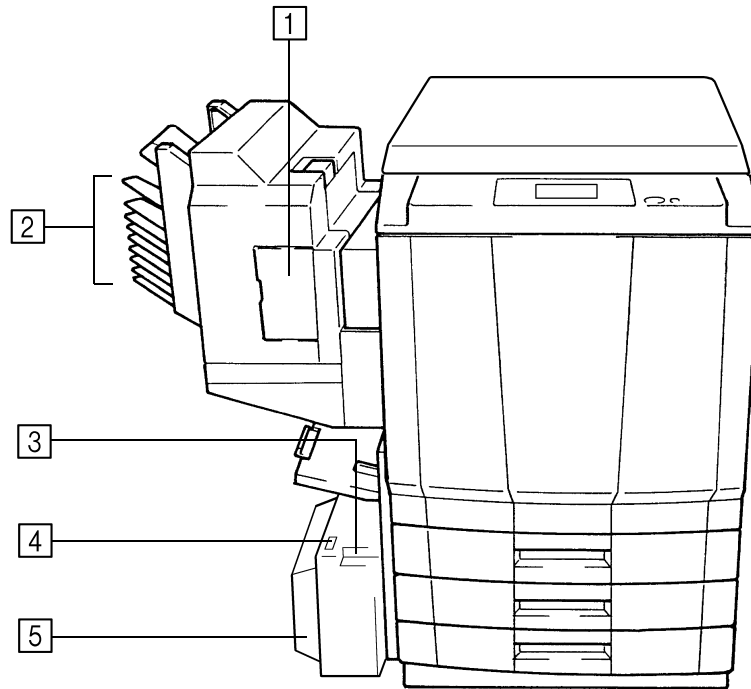

C41190006AA

Sorter / Staple Sorter

- 1 **Stapler Door:** Open to replace the Staple Cartridge.  p. 6-6
- 2 **Sort Bins:** Holds sorted or grouped prints.

Large Capacity Cassette

- 3 **Cassette Release Lever:** Use to release the cassette from the unit when it is necessary to clear a misfeed.
- 4 **Paper Plate Descent Key:** Press to lower the paper plate.
- 5 **Cassette Door:** Open to add paper or clear a misfed sheet of paper.

3. Operation Panel

Operation Panel Names and Functions

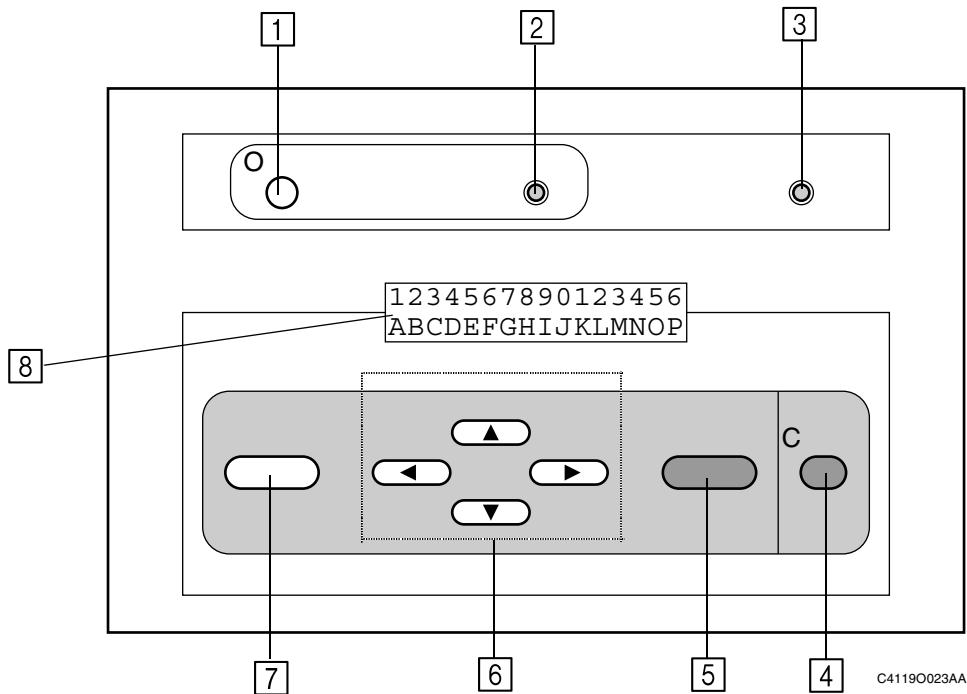

C4119O023AA

- 1 Online key**
ON: Printer is connected to the host PC.
OFF: The printer is not connected.
- 2 Ready LED**
ON: The printer is idle (normal state).
Blinking: The printer is processing or printing a job, or communicating with a remote computer.
OFF: The printer is off or warming up.
- 3 Message LED**
ON: A communication error has occurred between the Fiery X2e and the printer.
Blinking: An error has occurred that prevents printing.
OFF: There is no error.
- 4 Cancel key**
When the printer is in printer mode, switches from the Functions screen to the Status screens.
If pressed before paper feeding begins, cancels the current printing job.
- 5 Set key**
Selects the Functions menu.
Selects the currently displayed choice and proceeds to the next option.
- 6 ▲, ▼, ►, ◀ key**
The up arrow takes you to the next entry in the list.
The down arrow takes you to the previous entry in the list.
The right arrow in the setup menus advances the cursor to the text-entry position to the right.
The left arrow in the setup menus backspaces the cursor to the test-entry position to the left. In a text field, it deletes the characters to the left.
- 7 Menu key**
In the setup menus, takes you back one level.
When the printer is in printer mode, switches between the Info screen and the Functions screen.
- 8 LCD Panel**
2-line text display.

4. Computer Connection

Parallel Connection

Use a parallel interface cable when connecting this unit to the printer port of a computer.

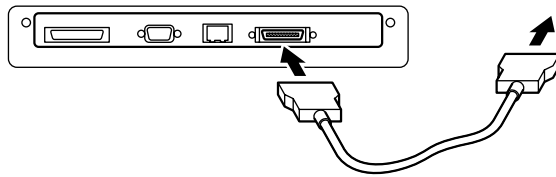

C4119O007AA

Network Connection

Use a network cable of 10Base-T or 100Base-T when connecting this unit to a computer by a network.

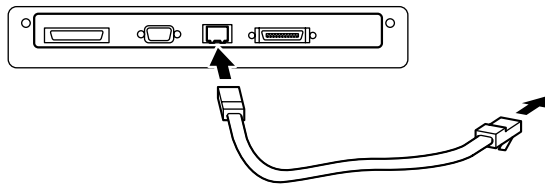

C4119O008AA

5. Turning ON and OFF

Turning ON and OFF

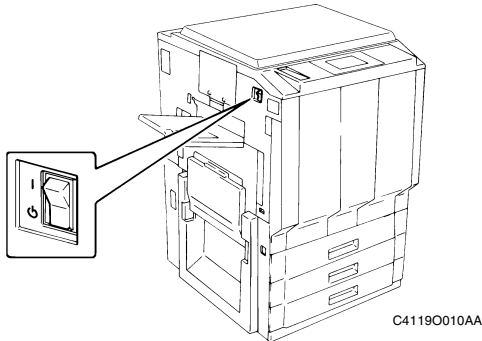

- Turning the printer ON
Press the Power Switch to the **I** (ON) position.
- Turning the printer OFF
Press the Power Switch to the **⏻** (OFF) position.

When the unit is turned ON

The operation panel changes as follows when the power is turned ON.

- (1) The printer self-test operation is performed automatically.

START SELF_TEST

- (2) It then enters the setup stand-by mode. Press any key (i.e. the menu key) when in this mode to switch to the setup mode. (See p. 4-4) It will enter the printing mode if no operations are made.

To update/setup
Press any key

- (3) The printer system is prepared if no operation is performed in the condition given above.

LOADING SYSTEM

- (4) The printer then enters the printing ready mode. The Ready lamp will be illuminated.

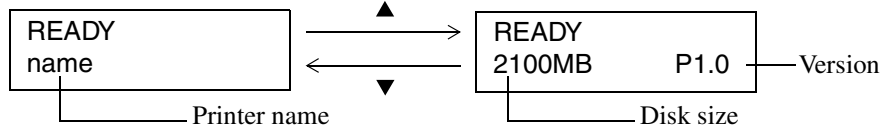

However, the printing operation cannot be performed even if data from the computer is sent at this time. A warm-up time of approximately nine minutes (at a room temperature of 20°C (68°F)) is required before printing can be performed. Data can be received and printing will commence in the order of receipt once warm-up is completed.

NOTES

- If the fusing temperature drops excessively during a multi-print cycle, there is a possibility that the printing speed will be reduced. The printing speed will automatically return to normal when the fusing temperature rises enough to ensure good fusing performance.
- When the power is switched ON but the CF911P does not display “Ready,” switch the power Off and On again.

Continuous Printing Precautions

The printing operation stops for the following intervals and the transfer drum cleaning operation is performed for approximately 40 seconds to maintain optimal performance of the color printer. Wait a moment when this condition occurs.

Full-color or monochrome printing:..... Every 24 prints for continuous printing and 48 prints for non-continuous printing.*

Black-and-white mode: Every 56 prints for continuous printing and 48 prints for non-continuous printing.*

* These figures vary according to the selected print size and other setting conditions.

Chapter 3

Printing Procedures

1. Printing

Printing Preparations

The printer driver for this unit must be installed in advance in the computer to perform the printing operations. Refer to the separate Getting Started manual for a description of the printer driver installation procedures.

Performing Printing

The software application which creates the document performs the printing. Various functions can be set by the print driver at this time. Refer to the separate User Guide.

2. Function Settings

Application Specification

The size and color of the document can be set by the software application of the document. Check the functions which can be set in the operation manual of the software application.

Printer Driver Specification

Special functions of this printer such as the sort and staple operation are set by the functions of the printer driver. The printer driver can be called from any dialog box that is opened when printing is performed. Refer to the printer driver operation manual for a detailed description of the setting procedures and setting items.

Printer driver screen

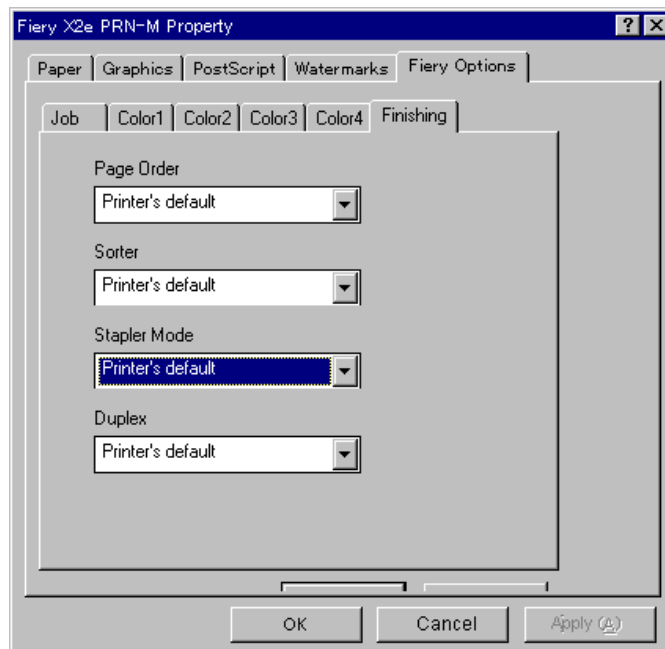

4119D003

Chapter 4

Setup Menu Settings

1. Setup Menu Summary

Possible Setting Items in the Setup Menu

The connection port, network settings, print job management and other items in the setup menu set the conditions when printing is performed.

The main menu contains the following selections. There are lower-position sub-menus depending on the main menu and the various items that can be set.

Refer to the Setup Menu Transition diagram (p. 4-11) for a detailed description of the possible setting items.

Setup Main Menu	Explanation
Setup Exit	Ends the setup menu.
Setup Server Setup	Sets the server conditions such as the server name, date, time and the job processing procedures.
Setup Network Setup	Sets the connection conditions such as the port that is used. Also sets the protocol, server address and other items when the unit is connected to a network.
Setup Printer Setup	Sets the conditions for the job processing of the printer name and queue.
Setup PS Setup	Sets the Postscript functions such as the color and the compression.
Setup Color Setup	Sets the conditions for color matching such as the color mode and target.
Setup Job Log Setup	Sets the job log storage and printing conditions.
Setup Calibration	Executes the calibration.
Setup Change Password	Changes the password.
Setup Clear Server	Initializes the server.

Setup Menu Hierarchy

The setup menu contains a number of levels of submenus under the main menu that were explained in the chart on the previous page. A submenu is separated into four levels. The lowest levels are [Network Setup], [Protocol Setup], [IPX/SPX Setup] and [Frame Types].

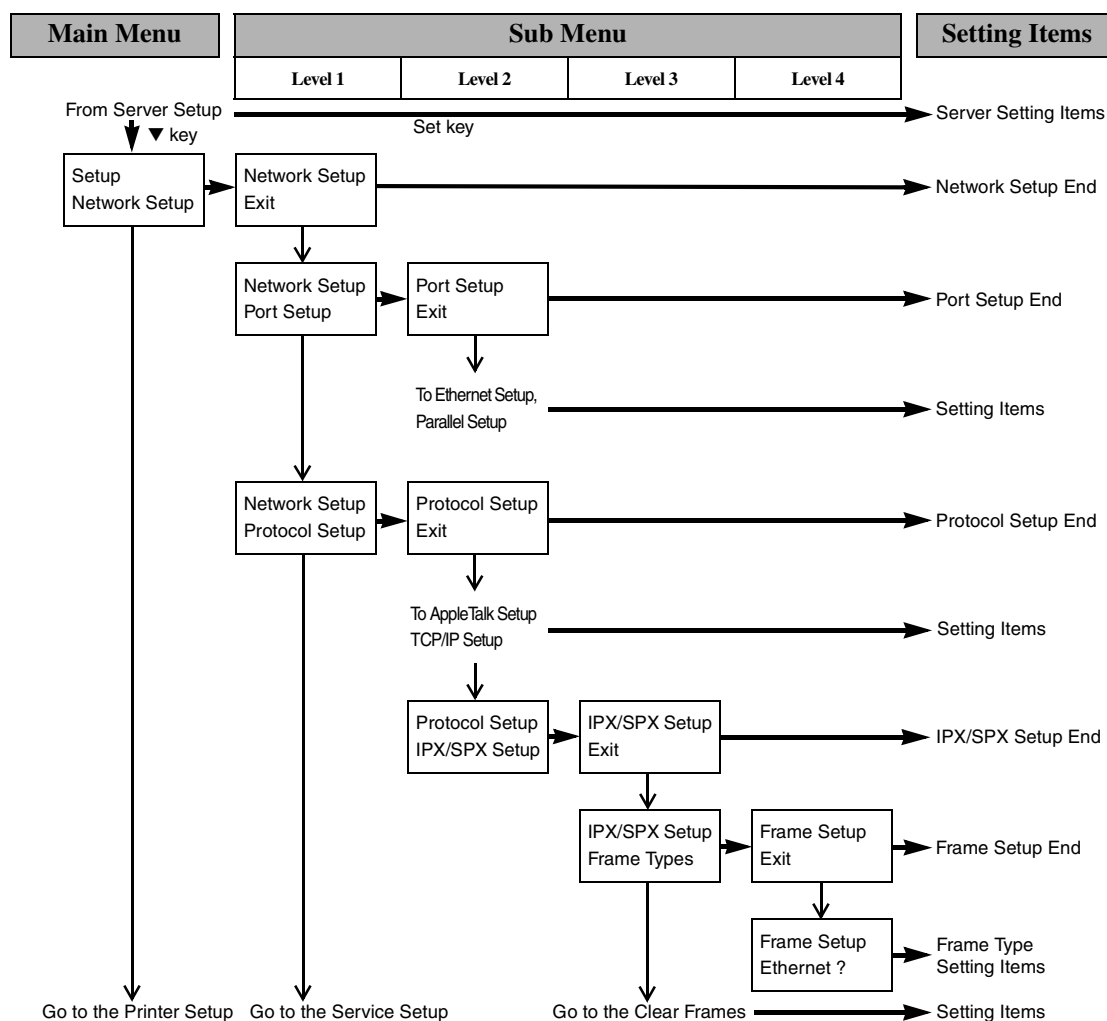

Setup Menu Keys

The following keys are used to switch between the levels and menus.

- ▲, ▼ keys: These keys switch between the menus, items and setting values that are displayed. The operation corresponds to the sequence indicated by the arrow marks in the figure shown above. These keys are also used to switch between numerical values and characters.
- ▶, ◀ keys: These keys shift the cursor horizontally within the display.
- Set key: This key selects the menus and items that are displayed and the menu display and items in the lower level. The operation corresponds to the horizontal arrow marks in the figure above.
- Cancel key: This key interrupts the menu and items that are displayed and returns operation to the menu and items at the previous upper level.

2. Setup Menu Procedures

Starting the Setup Menu.

The Setup menu is made available when the printer is started.

- (1) Turn on the power.
- (2) Press any key (i.e. the menu key) when the following message is displayed.

To update/setup
Press any key

This message is displayed for approximately 5 seconds. If no operation is performed at this time, the printer ready mode is set. The following service option screen is displayed by pressing any key.

Startup
Run Setup

- (3) To access the setup menu, press the **Set** key while “**Startup Run Setup**” is displayed. This will open the setup menu and the following screen will be displayed.

LOADING SETTINGS

If a password is set, enter the password in the following operation. [**Setup Exit**] at the beginning of the setup menu will be displayed if no password has been set.

Useful Tips

- Select “Startup Start System” under Service Options, then press the Set key to enter the print ready state.
 - In addition, under Service options, a service menu in which the printer program can be checked and updated can be selected. For details on the service menu, please ask the service man.
-

- (4) When a password has been set, enter the password.

ENTER PASSWORD
Password

Use the ▲ or ▼ key to switch the display of the first character.

Use the ► key to shift the cursor to the second character and set the second and subsequent characters in the same manner as the first character.

After the password is input, press the **Set** key.

When the password has been confirmed, the “**Setup Exit**” screen in the Setup menu is displayed.

Setup
Exit

Operating the Setup Menu

The Setup menu is accessed in the following sequence: Menu selection → Set key → Submenu selection → Set key → Select the desired setting menu and change the setting.

Refer to the section “Setup Menu Transition Diagram” (p. 4-11) for an illustration of the menu hierarchy and the items that can be set.

- (1) Use the ▼ and ▲ keys to select the main menu.

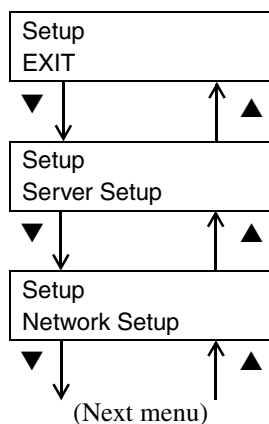

- (2) Press the **Set** key. The submenu of the selected main menu (Level 1) is displayed. There may be no submenu depending on the main menu that is selected and the setting items may be displayed instead (p. 4-11).

This example explains the condition when [Network Setup] is selected from the main menu.

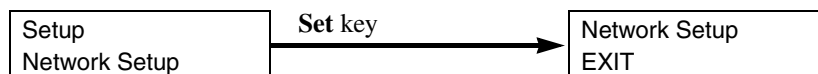

If the **Set** key is pressed by mistake, press the **Cancel** key to return to the previous menu.

- (3) Use the ▼ and ▲ keys to select the submenu (Level 1)

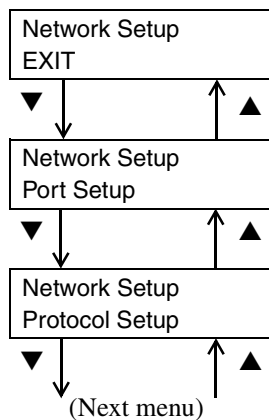

2. Setup Menu Procedures

- (4) Press the **Set** key. Level 2 of the selected submenu (Level 1) is displayed. There may not be a Level 2 depending on the main menu that is selected, and the setting item is displayed instead (☞ p. 4-11).

This example indicates the condition when [**Protocol Setup**] is selected in the first level.

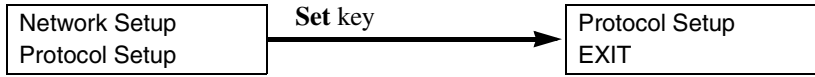

- (5) Use the ▼ and ▲ keys to select the submenu hierarchy (Level 2).

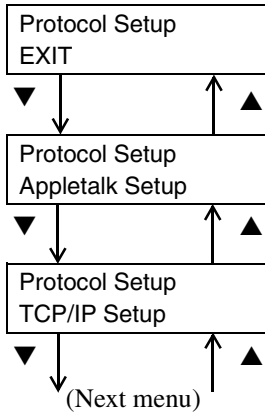

- (6) Press the **Set** key. Level 3 of the selected submenu (Level 2) is displayed. There may not be a Level 3 and the setting items may be displayed instead, depending on the selected menu (☞ p. 4-11).

This example describes the condition when [**TCP/IP**] is selected in level 2.

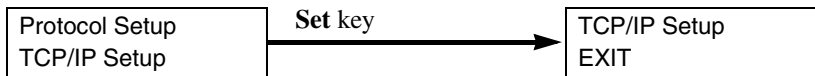

- (7) Use the ▼ and ▲ keys to select the submenu (Level 3).

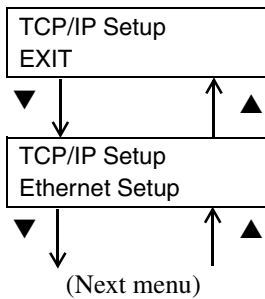

- (8) Press the **Set** key. The first setting item of the selected submenu (Level 3) is displayed. The menu on Level 4 may be displayed depending on the main menu that is selected (☞ p. 4-11).
Select the menu in the same manner.

This example describes the condition when the **[Ethernet Setup]** is selected in the level 3.

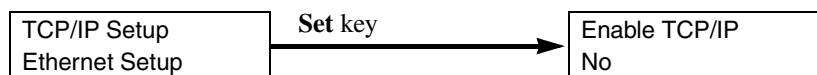

Useful Tip

The **[Network Setup]** settings are required when the printer is connected to a network. In this case, the **[Protocol Setup] - [TCP/IP Setup]** is set directly for this explanation. However, do not actually set only **[Protocol Setup]** but set also **[Service Setup]** and **[Port Setup]** simultaneously.

- (9) Use the ▼ and ▲ keys to select the setting value of the item. (In this example, the setting value is Yes/No.)

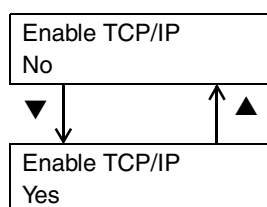

- (10) Press the **Set** key. The following setting item is displayed.

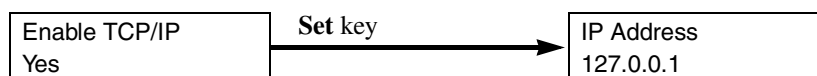

- (11) Use the ▼ and ▲ keys to switch the numeric characters when performing the settings. Press the ► key to shift the cursor (underlined section) to switch the following numeric characters.

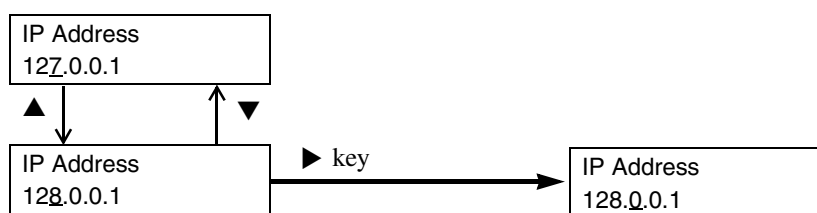

- (12) Set all the numeric characters and press the **Set** key. The following setting item is displayed.

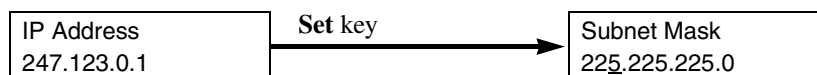

- (13) Set this item by the same procedure as described in step (11) and press the **Set** key. This ends the Ethernet setting and operation shifts to the TCP/IP setup end menu.

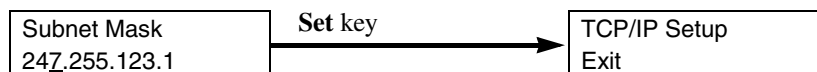

- (14) Continue these procedures to set the other items in the TCP/IP Setup menu.

- (15) In the Setup menu, set “Save Changes” to “Yes.” (☞ p. 4-10).

3. Server Setup Menu

Server Setup Menu Hierarchy

The information for the print server and the job processing procedures are set in the Server Setup menu. The setting items are displayed if the main menu is selected instead of the server menu.

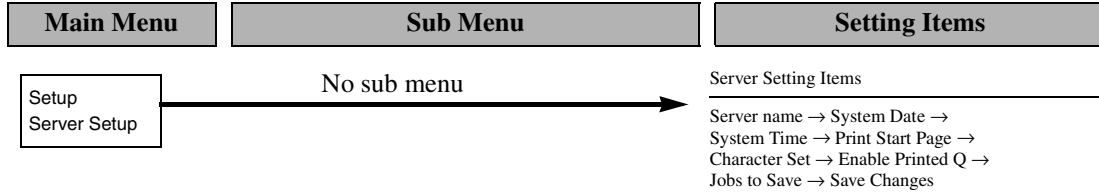

Server Setup Menu Setting Items

Select [Server Setup] in the main menu. The displayed setting items are set in the following sequence.

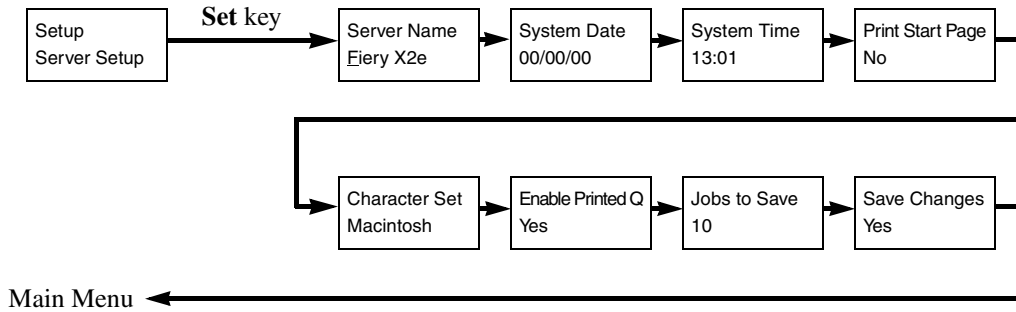

Server Setup Menu Setting Item Details

This section describes the display contents and meanings for each setting item.

Server Name



Function: This sets the printer name that is displayed in the panel during print standby.
Operation: Use the ▼ and ▲ keys to switch the character display. Use the ► key to shift the cursor (underlined section). Repeat this operation to set the name.
 After the settings are completed, press the **Set** key and the following item [**System Date**] is displayed.
[Save Change] will be displayed if the **Cancel** key is pressed midway through the process.

System Date

System Date 00/00/00	←	Date
-------------------------	---	------

Function: This sets the style of the date for the printer time (date information) to Month/Day/Year.

Operation: Use the ▼ and ▲ keys to switch the display of the numeric characters. Use the ► key to shift the cursor (underlined section). Repeat this operation to set the date. After this operation is performed, press the **Set** key to display the following item, **[System Time]**. **[Save Change]** will be displayed if the **Cancel** key is pressed midway through the process.

System Time

System Time 13:01	←	Time
----------------------	---	------

Function: This sets the time for the printer (time information).

Operation: Use the ▼ and ▲ keys to switch the display of the numeric characters. Use the ► key to shift the cursor (underlined section). Repeat this operation to set the current time.

After the setting is made, press the **Set** key to display the following item, **[Print Start Page]**.

[Save Change] will be displayed if the **Cancel** key is pressed midway through the process.

Print Start Page

Print Start Page No

Function: This sets the starting print page for each job.

Operation: Use the ▼ and ▲ keys to switch the Yes/No setting. After the setting is made, press the **Set** key to display the next item, **[Character Set]**.

[Save Change] will be displayed if the **Cancel** key is pressed midway through the process.

Character Set

Character Set Macintosh

Function: This sets the panel display font.

Operation: Use the ▼ and ▲ keys to select the display font for the Macintosh, Windows or DOS operating systems.

Macintosh: This sets the character set to the fonts used on a Macintosh.

Windows: This sets the character set to the fonts used in Windows.

DOS: This sets the character set to the fonts used in DOS.

After the setting is made, press the **Set** key to display the following item, **[Print Queue]**.

[Save Change] will be displayed if the **Cancel** key is pressed midway through the process.

3. Server Setup Menu

Enable Printed Queue

Enable Printed Q Yes

Function: The setting determines if the print queue is used.

Operation: Use the ▼ and ▲ keys to switch the Yes/No setting. Press the **Set** key to display the next item [**Jobs to Save**]. If “No” is set, [**Save Change**] is displayed if the **Set** key is pressed. [**Save Change**] will be displayed if the **Cancel** key is pressed midway through the process.

Jobs to Save

Jobs to Save 10

Function: When the print queue is used, (the previous item [**Print Queue**] is set to “Yes”) the number of jobs that are stored in the queue is set.

Operation: Use the ▼ and ▲ keys to switch the display of the numeric characters. Use the ► key to shift the cursor (underlined section). Repeat this operation to set the number of jobs.

After the setting is made, press the **Set** key to display [**Save Change**]. After the setting is performed, press the **Set** key to display the following item, [**Save Change**].

[**Save Change**] will be displayed if the **Cancel** key is pressed midway through the process.

Save Change

Save Changes Yes

Function: This setting determines whether the conditions set in the Server Setup menu are saved or not.

Operation: Use the ▼ and ▲ keys to switch the display of the numeric characters. If “Yes” is set and the **Set** key is pressed, the changed settings are saved and the main menu display returns. If “No” is set and the **Set** key is pressed, the changes in the settings are not stored and the main menu display returns.

NOTE

Any Other Menu Setup Procedures

See Chapter 2 “Performing Setup from the Control Panel” in the Administrator Guide.

4. Setup Menu Transition Diagram

The setup menu configuration is shown in the Menu Map. Before starting the settings, verify the position and structure of the required setting items.

To print out the Menu Map:

Press the Menu key.

The message “Print Pages” appears, press the Set key.

Press the down key and select “Menu Map”.

Press the Set key.

The Menu Map is printed out.

Chapter 5

Function Menu Settings

1. Function Menu Summary

Function Menu Setting Items

A test pattern that verifies the printer conditions can be printed and printing can be suspended (temporary stop) and resumed (start operation again) in the function menu.

The main menu contains the following selections. There are lower-position submenus depending on the main menu and various items can be set.

Refer to the Function Menu Transition Diagram (p. 5-4) for a detailed description of the possible setting items.

Function Main Menu	Explanation
Function Print Pages	Enables you to print special pages from the printer.
Function Suspend Printing	This option interrupts the current print job. If it has not finished processing, the RIP will continue but the job will not print. You can then select Resume Printing and the printer will print the job and continue processing and printing jobs. NOTE: Do not select Suspend Printing while printing duplex or sort jobs.
Function Resume Print	Resumes printing.
Function Run Diagnostics	This function is provided for service representatives only. Contact your authorized service/support technician for information about running diagnostics.
Function Reboot Server	Shuts down all printing activity properly and then restarts the Fiery X2e. Access to Fiery X2e Setup options are made available at this time.

NOTE

See Chapter 1 “Using the Control Panel” in the User Guide.

2. Function Menu Operation Procedures

Starting the Function Menu

- (1) Press the MENU key.

The function menu is accessed and the following screen is displayed.

Functions
Print Page

Function Menu Keys

The following keys are used to move the among menus.

- ▲ , ▼ keys: These keys switch between the menus, items and setting values that are displayed. The operation is performed in the sequence indicated by the vertical arrow marks in the figures. These keys are also used to switch between the numerical values and characters.
- ▶ , ◀ keys: These keys shift the cursor horizontally within the display.
- Set key: This key selects the menus and items that are displayed and the menu and items in the lower level. This operation corresponds to the horizontal arrow marks in the figures.
- Cancel key: This key interrupts the menu and items that are displayed and returns operation to the menu and items at the previous upper level.

Function Menu Operation

The Function Menu can be operated by the same procedures as the Setup Menu. (☞ p. 4-5)

3. Function Menu Transition Diagram

The function menu configuration is shown in the following diagram. Before starting the settings, verify the position and structure of the required setting items.

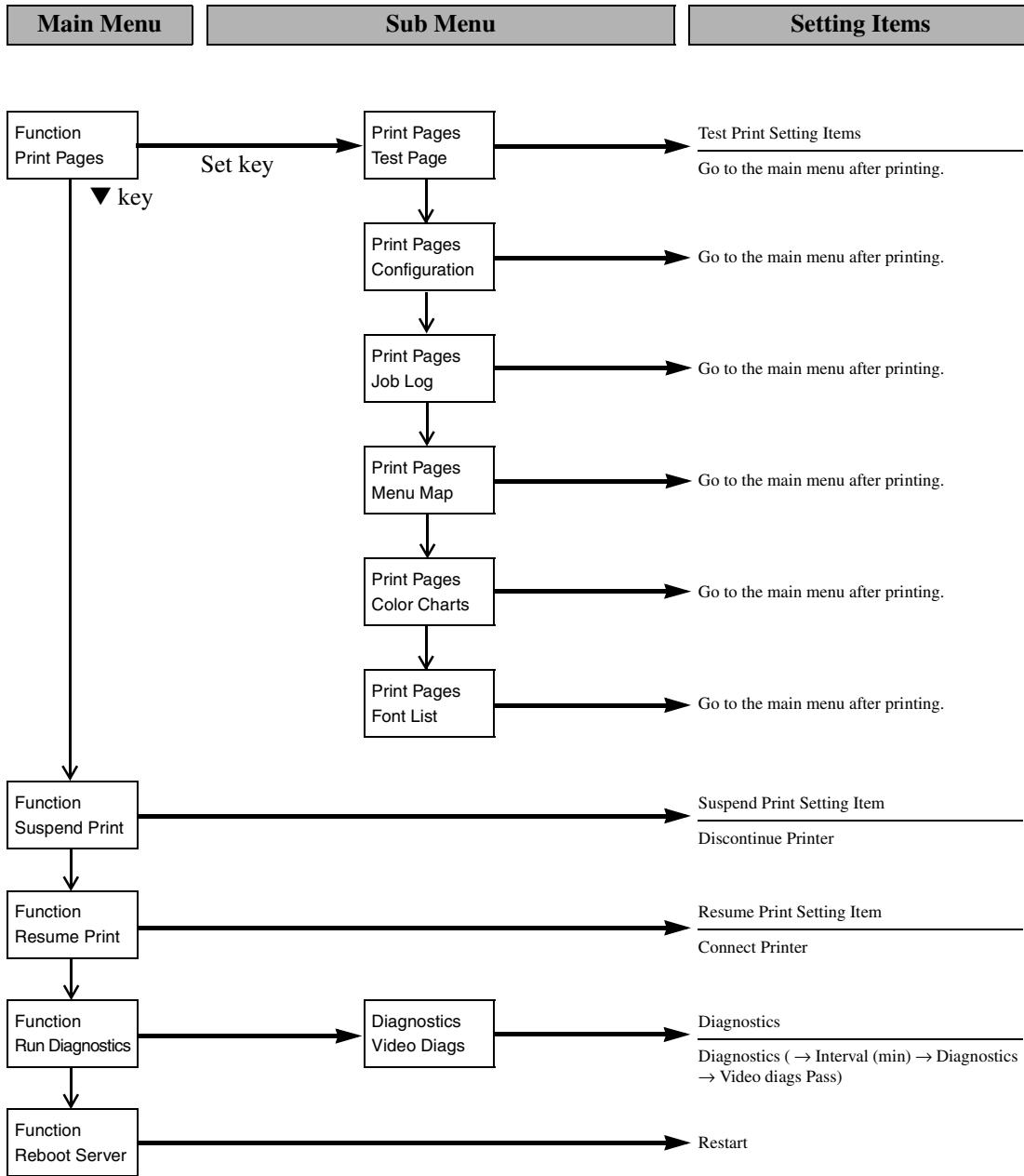

Chapter 5
Function Menu Settings

Chapter 6

When a Message Appears

Chapter 6

When a Message Appears

1. When the Message “LOAD IN ANY TRAY” is displayed.

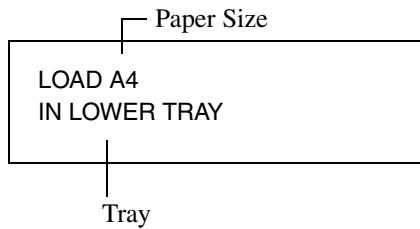

The message shown on the left is displayed when the Tray currently selected for use runs out of paper. The current print cycle is interrupted and you cannot start a new print cycle. Load the tray with paper by performing the following procedure:

NOTE

Only the following type of paper can be loaded in the tray. Use of paper recommended by our company is encouraged to maintain a standard level of print quality and prevent paper misfeeds.

- Paper weight: 64g/m² to 105g/m² (17 lbs. to 28 lbs.)
- Size: A3 lengthwise to A5 lengthwise

(11"×17" lengthwise to Invoice lengthwise)

Thick paper (Heavy Stock 2) and OHP transparencies cannot be loaded in the tray.

Paper Loading Procedures

Upper and Lower Trays

- 1 Slide the Tray out.
- 2 Load the paper stack into the Tray so that its front side (the side facing up when the package was unwrapped) **faces down**. Then, slide the Tray back in.

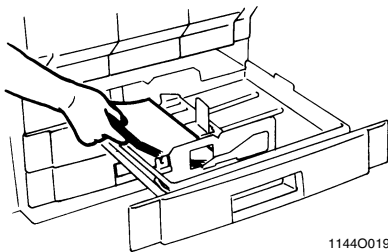

1144O019AA

NOTES

- Up to 500 sheets of paper (80g/m²) (21-1/4 lbs.) can be loaded.
- The paper should be loaded no higher than the ▼ (Max. Level Indicator).

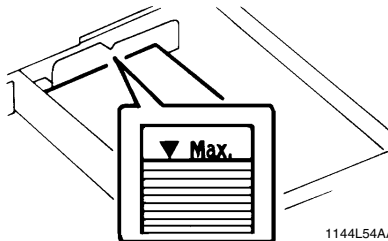

1144L54AA

Middle Tray

- 1 Slide the Tray out.
- 2 Load the paper stack into the Tray so that its front side (the side facing up when the package was unwrapped) faces down. Then, slide the Tray back in.

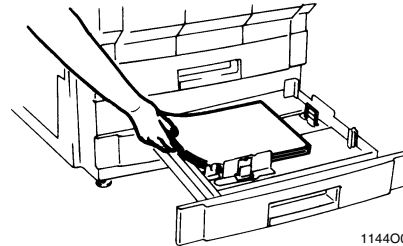

1144O022AA

NOTES

- Up to 250 sheets of paper (80g/m²) (21-1/4 lbs.) can be loaded.
- The paper should be loaded no higher than the ▼ (Max. Level Indicator).

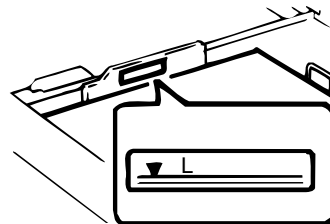

1144L044AA

1. When the Message "LOAD IN ANY TRAY" is displayed.

Changing the Paper Size for the Middle Tray (Universal Tray)

- 1 Grasp the tab of the Edge Guide and slide it to the size of the paper to be loaded. Pressing the plastic part of the Trailing Edge Stop, slide it to the size of the paper to be loaded.

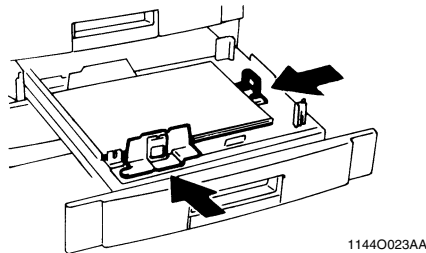
**NOTE**

When loading A3 (11"×17") paper: Move the Trailing Edge Stop all the way to the right. Then, pinch the Lever as shown and remove it from the Stop. Next, fit the Lever into position as shown.

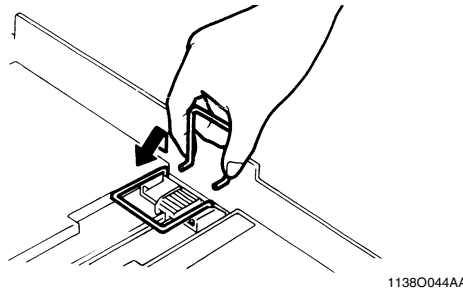
**When loading Inch size paper**

Flip the Switch, located in the right rear corner of the Tray, to "Inch".

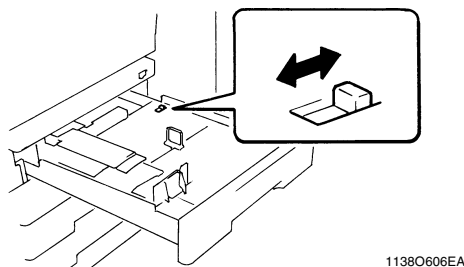
**Large Capacity Cassette**

- 1 Grasping the Door Lock Release Lever, open the Cassette Door.

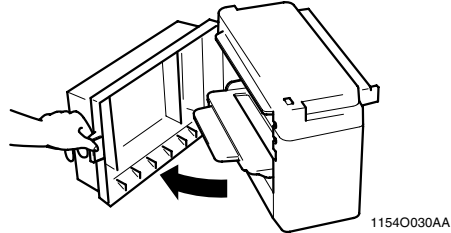

When adding paper to a partially loaded Cassette, press the paper Plate Descent Key to lower the Paper Plate before opening the Cassette Door.

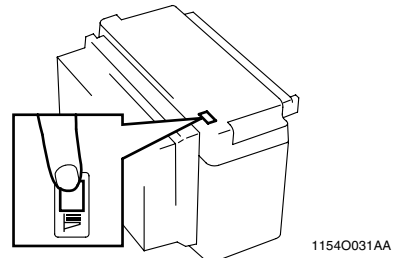

- 2 Place the paper stack onto the Paper Plate so that its front side faces up and close the Cassette Door.
*This causes the Paper Plate to rise automatically.

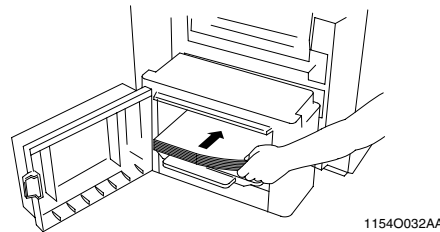
**NOTES**

- Make sure that the leading edge of the paper stack is pressed tightly up against the Guide Plate on the take-up side of the Cassette.
- The paper should be loaded no higher than the ▼ (Max. Level Indicator).

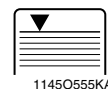

- The Paper Plate may not ascend if the Cassette Door is not closed completely. Be sure to close the Door completely.

2. When the Message “TONER NEAR EMPTY” or “NO TONER” Appears

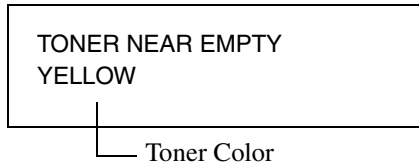

The message shown on the left appears when toner will run out soon. You can still make prints, but the image density will become lighter and lighter. It is recommended that you replenish the toner as soon as possible for this reason.

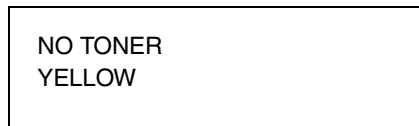

When toner has run out, the message shown on the left is displayed and you can no longer start a new print cycle. Follow the procedures described below to replenish the toner.

Replenishing Toner

- 1 Open the Front Door.
(Example: Yellow Toner is empty.)

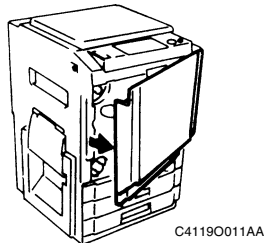

- 2 Slide out the Toner Hopper Unit.

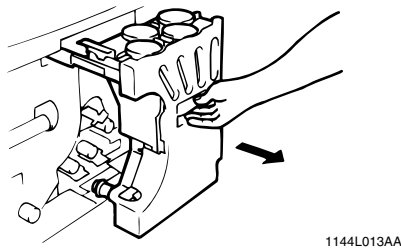

- 3 Sharply tap the new Toner Bottle against a desk or other hard object four to five times. Then turn the Toner Bottle upside down and tap it the same way again.

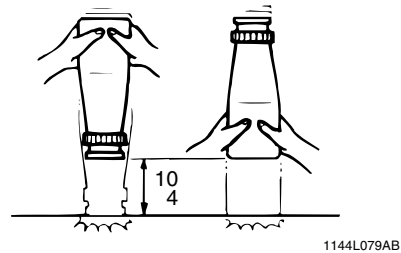

- 4 Shake the Toner Bottle well.

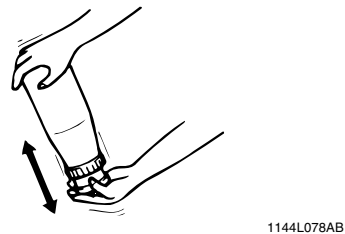

2. When the Message “TONER NEAR EMPTY” or “NO TONER” Appears

- 5** Remove the bottle cap and peel off the seal.

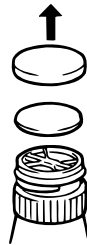

1144L016AA

- 6** Open the Toner Hopper Lid.

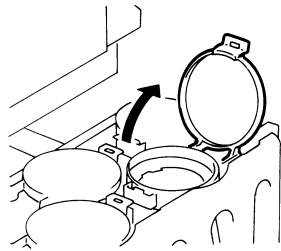

1144L014AA

NOTE

Make absolutely certain that the color of the toner matches the color of the Toner Hopper Lid.

- 7** Align the tab on the Bottle with the cutout on the Toner Receptacle and turn the Bottle clockwise until it stops.

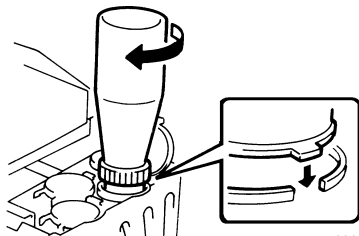

1144L017AA

- 8** After the toner stops falling in (approx. 60 seconds), tap the Bottle a few times to ensure that all the toner falls into the Hopper.

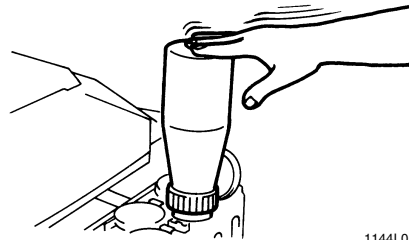

1144L018AA

- 9** Making sure that the toner has emptied completely, turn the Bottle counterclockwise and lift it out of the Receptacle. Close the Toner Hopper Lid.

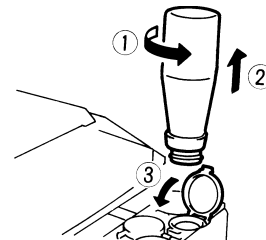

1144L019AA

NOTE

Please wait for a while after the toner has fallen in completely. If not, toner powder may be blown up from the Toner Hopper.

- 10** Slide the Toner Hopper Unit back in and close the Front Door.

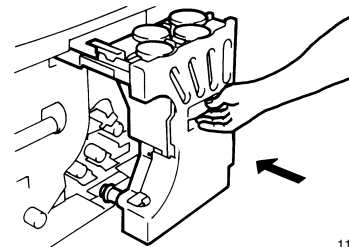

1144L020AA

- 11** Use the same procedure to add toner for the other three Main Hoppers.

3. When the Message “NO STAPLE” Appears

NO STAPLE

The message shown on the left appears when the staples are running out.

Replace the Staple Cartridge with a new one by following the procedure given below.

Replacing the Staple Cartridge

- 1** While holding the Lock Release Lever, slide the Staple Sorter away from the unit.

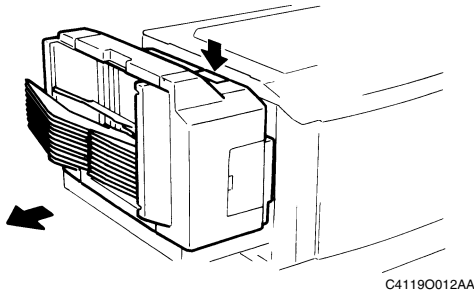

- 2** Open the Stapler Door.

- 3** While pushing up the Staple Cartridge Release Lever, pull the Staple Cartridge out of its port.

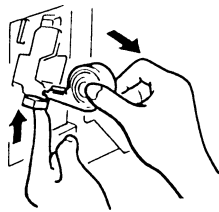

- 4** Pull the staple sheet about 3 cm out of the new Staple Cartridge and break off that portion.

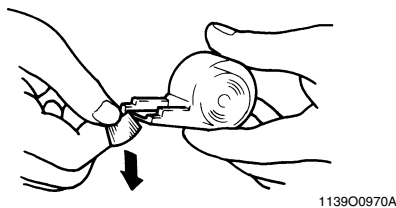

NOTE

Check that no portion of the staple sheet hangs out of the Cartridge. Break off any portion of the sheet that hangs out of the Cartridge.

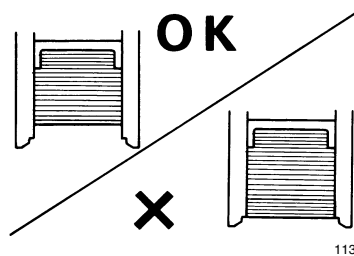

- 5** Insert the new Staple Cartridge until a click is heard.

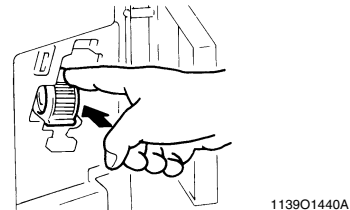

- 6** Close the Stapler Door and slide the Staple Sorter back against the printer.

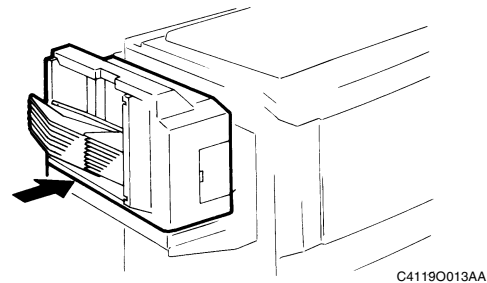

3. When the Message “NO STAPLE” Appears

- 7 Place a sheet of paper into the 2nd Bin of the Staple Sorter.

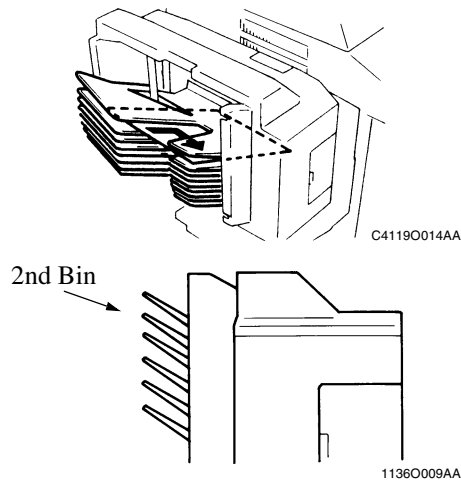

- 8 Test Print from software application. Then, the Staple Sorter test-staples the paper several times automatically. Setup the PDD options Application Menu print, click “property”, click “Fiery Options”, click “Finishing”, click Stapler Mode “on”.

- 9 Remove the sheet of paper from the 2nd Bin and check that it has been stapled.

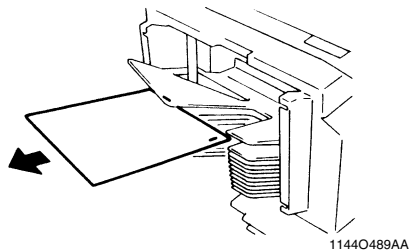

- * If no staples are evident, place another sheet of paper into the 2nd Bin and repeat steps 7, 8, and 9.

NOTES

- Replace the Staple Cartridge only after you are prompted to do so by the message. Removing the Staple Cartridge before then will result in stapling trouble.
- Immediately after the new Staple Cartridge has been loaded, be sure to test-staple the paper following steps 7 through 9.
- DO NOT turn the green gear near the Cartridge inside the Staple Unit.

4. When “Misfeeding Occurs.”

If a paper misfeed occurs during a print cycle, the message shown on the left is displayed and that particular print cycle is stopped in the middle of operation.

Clear the misfed sheet of paper according to the procedure given below.

Misfeed Location

Different procedures are used to clear a misfed sheet of paper depending on the location. First, isolate the location, then clear the misfeed following the procedure applicable to where the misfeed occurred.

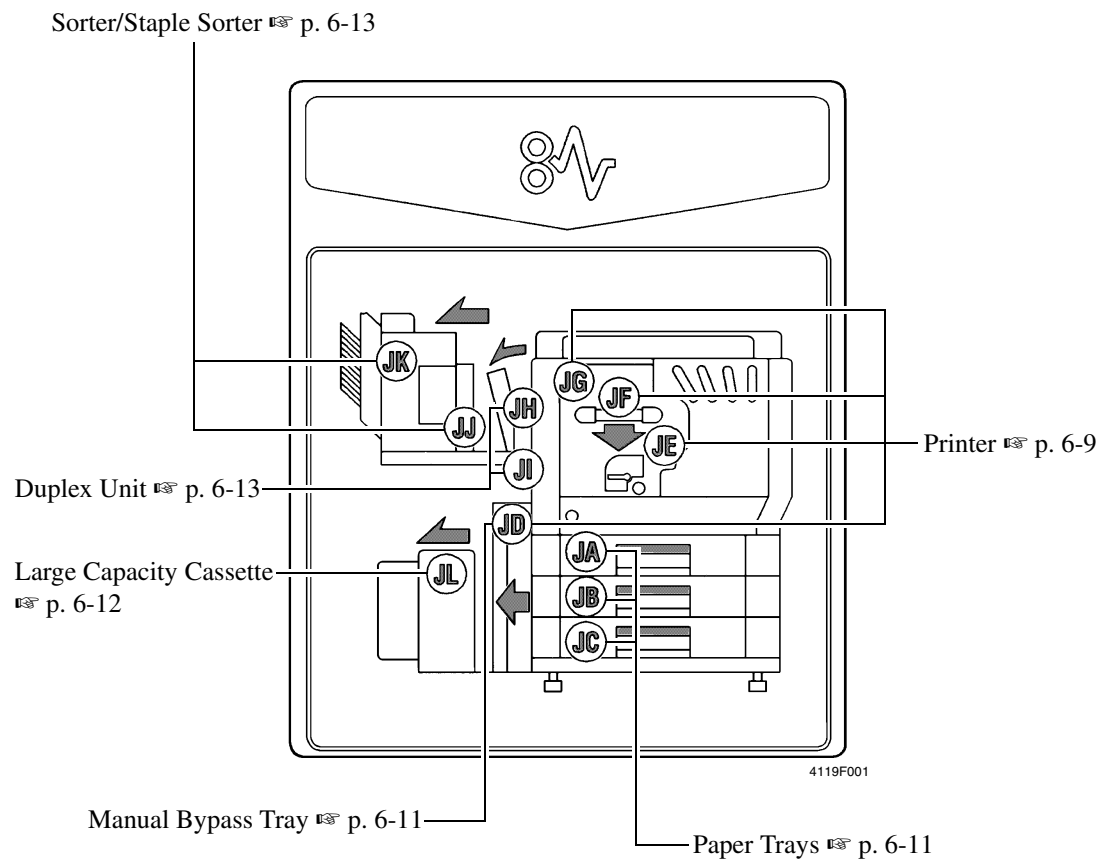

Misfeed in the unit

- 1** Open the Left Door (L1) .

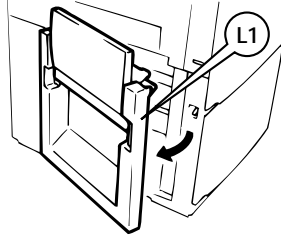

1144O548AA

- 2** Pull out the sheet of paper from the Transport Section.

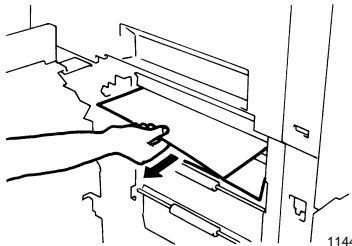

1144L022AA

- 3** Raise the Guide Plate (M2) , turn Knob (M1) and pull out the sheet of paper.

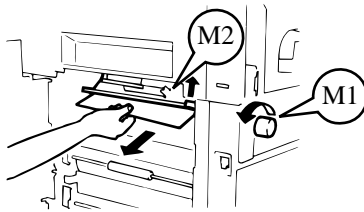

1144L023AA

- 4** Press down Guide Plate (M3) and pull out the sheet of paper.

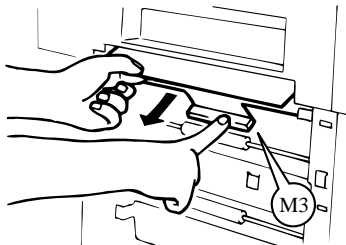

1144L024AA

- 5** Close the Left Door (L1) .

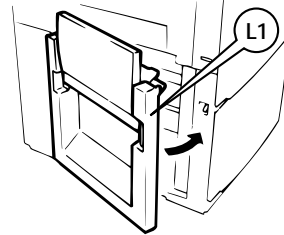

1144O549AA

- 6** Open the Front Door.

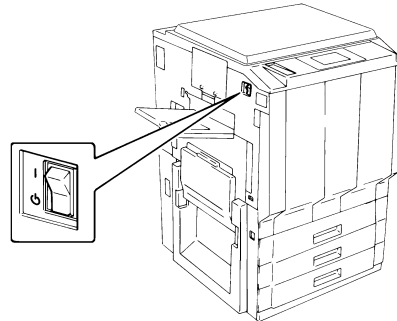

C4119O010AA

- 7** Turn Lever (M4) to the left. Press Guide Plate (L2) , turn Knob (M5) and pull out the sheet of paper.

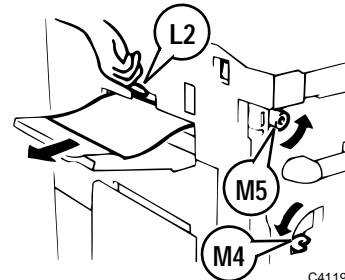

C4119O016AA

- 8** Grasp Lever (M6) and slide out the Transfer/Fusing Unit.

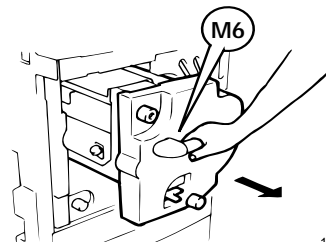

1144L027AB

4. When "Misfeeding Occurs."

- 9** Grasp the Fusing Unit Lever (M7) and open the Fusing Unit.

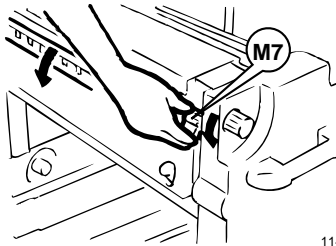

1144L028AB

CAUTION

DO NOT touch any parts except the paper as the Fusing Unit and its surrounding areas are extremely hot.

- 10** While turning Knob (M5), pull out the sheet of paper and close the Fusing Unit.

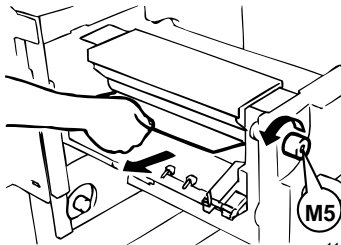

1144L029AB

- 11** Pull out the sheet of paper from the Upper Area of the Transfer/Fusing Unit.

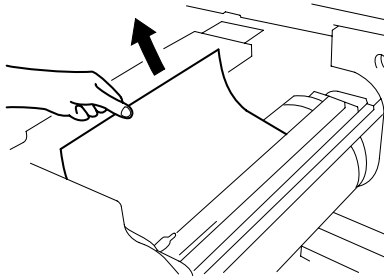

1154O016AA

- 12** While turning Knob (M9), remove the sheet of paper. If the paper adheres to the Transfer Film, gently disengage the leading edge of the paper and remove it, being careful not to damage the Transfer Film.

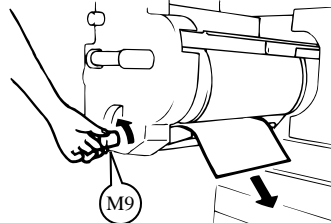

1144L031AA

- 13** Press down on the Roller and remove any sheet of paper that is inside the unit.

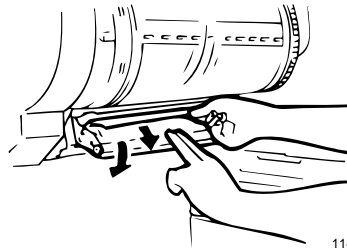

1144L069AA

- 14** Slide the Transfer/Fusing Unit back into the printer and turn the Release Lever (M4) to the right.

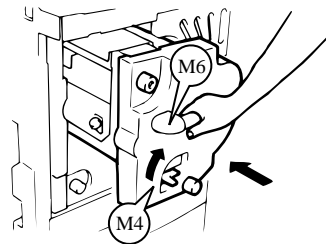

1144L032AB

- 15** Close the Front Door.

Paper Trays

- 1 Open the Left Door (L1) and pull out the sheet of paper from the Transport Section.

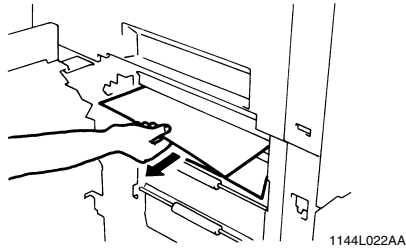

- 2 Close the Left Door (L1).
- 3 Slide the Tray out.

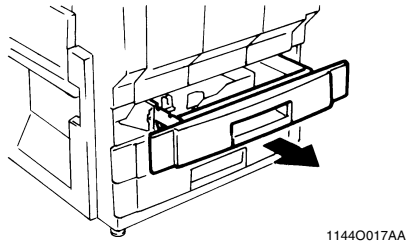

- 4 Unload the paper stack from the Tray. Fan the paper thoroughly and reload it in the Tray.

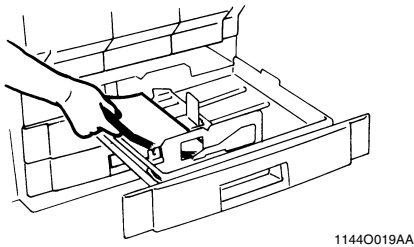

- 5 Slide the Tray back in.
- 6 Open the Front Door and then close it to reset the misfeed message on the Control Panel.

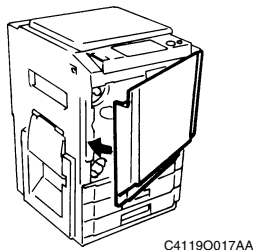

Manual Bypass Tray

- 1 Unload the paper stack from the Manual Bypass Tray. Then open the Left Door (L1).

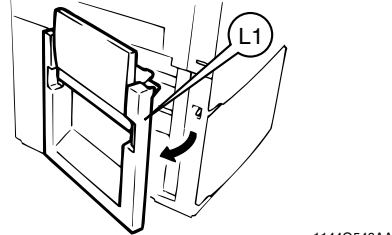

- 2 Pull out the sheet of paper. Raise the Guide plate (M2), turning knob (M1) and pull out the sheet of paper and close the Left Door.

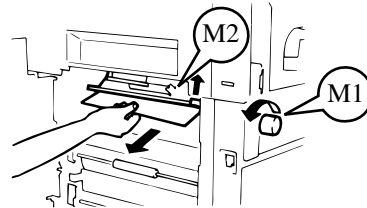

- 3 Fan the paper stack thoroughly and place it back on the Tray.

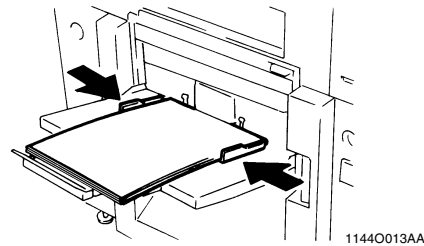

- 4 Open the Front Door and then close it to reset the misfeed message on the Control Panel.

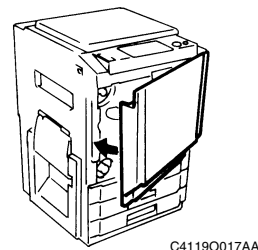

4. When "Misfeeding Occurs."

Large Capacity Cassette

1 Press the Paper Descent Key.

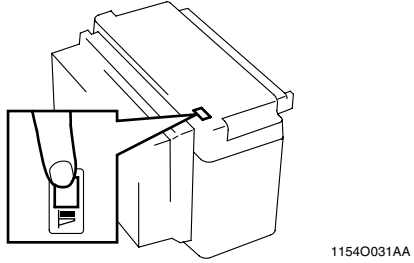

2 Grasping the Door Lock Release Lever, open the Cassette Door and remove the sheet of paper.

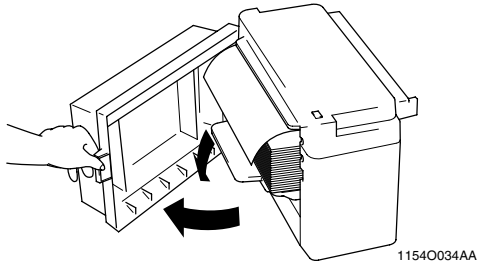

3 Close the Cassette Door.

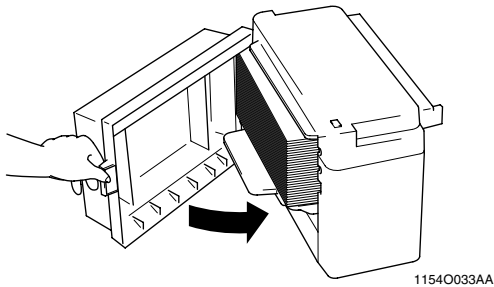

4 Slide the cassette away from the main unit.

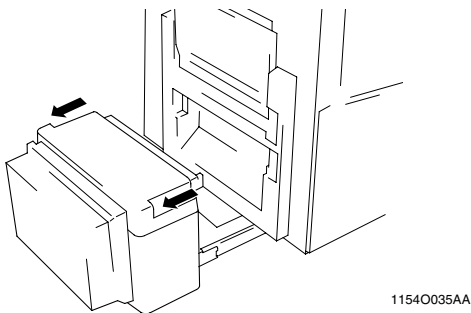

5 Remove the sheet of paper.

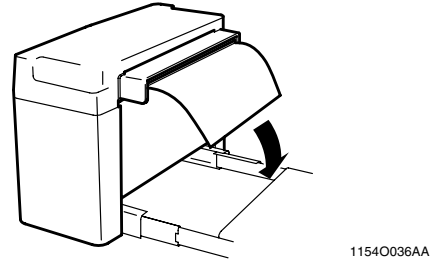

6 Slide the Cassette back against the printer.

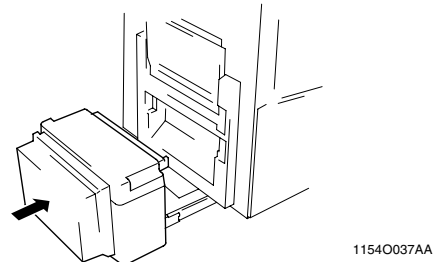

Duplex Unit

- 1 Grasping the Lock Release Lever, open the Duplex Unit.

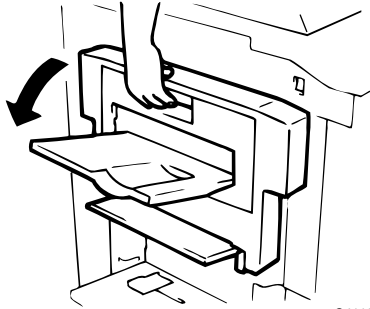

C41190018AA

- 2 Open the Misfeed Removal Guide (D) and remove the sheet of paper.

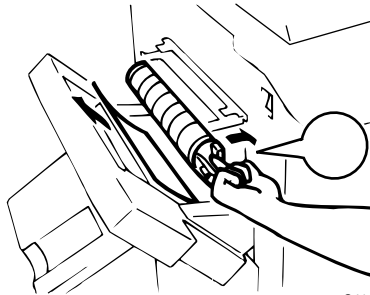

C41190019AA

- 3 Close the Duplex Unit.

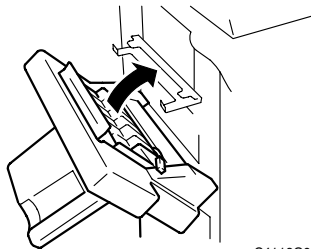

C41190020AA

Sorter/Staple Sorter

- 1 While holding the Lock Release Lever, slide the Sorter away from the unit.

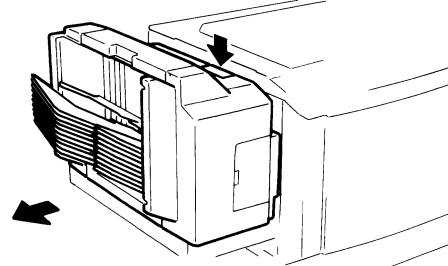

C41190012AA

- 2 Pull out the sheet of paper from the Transport Section.

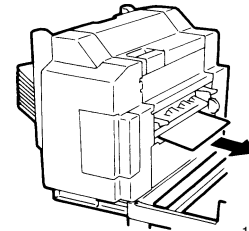

113900870A

- 3 Slide the Sorter back against the printer.

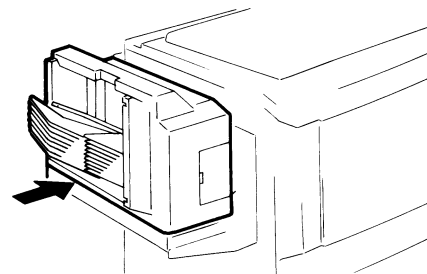

C41190013AA

5. When the Message “Fuser Oil Near Empty” Appears

The message shown on the left appears when the Fuser Oil is running out. You can still make printings, but it is recommended that you replenish the Fuser Oil as soon as possible.

When Fuser Oil has run out, the message shown on the left appears and you can no longer start a new print cycle. Replenish the Fuser Oil, **Call your technical representative.**

6. When the Message “Alert, Service Code” is displayed.

When the message “Alert, Service Code” is displayed on the LCD panel, the image stabilization function of the unit has malfunctioned. Contact your Tech. Rep.

IMPORTANT

When you contact your Technical Representative, inform him/her of the number or numbers of items which are displayed on the second line (Press the ▼ key, displayed Error Code on the second line.)

7. What Does Each Message Mean?

What Does Each Message Mean?

Message	Cause	Action
“Alert” “Service Code”	The unit malfunctioned and is unable to produce prints.	Press the ▼ key. Call and inform your Technical Representative of the trouble code message on the display.
“Check toner hopper”	The toner hopper is not set securely and the unit is unable to produce prints.	Check the toner hopper. ☞ p. 6-4
“Door open or xxxx is not attached”	A unit door is left open or an option is not attached properly and the unit is unable to produce prints.	Close the door or cover and attach the option properly.
“Fuser oil nearly empty”	The Fuser Oil is running out.	Call your technical representative.
“Load xx in yyyy tray”	The currently selected Tray has run out of paper.	Load the Tray with paper. ☞ p. 6-2
Max. # for 2-sided printings is 1.	You have entered 2 or more for the number of printings to be made in a 2-sided print mode.	Reenter 1 for the number of printings to be made.
Max. # of sets for sorting is 10.	You have entered 11 or more for the number of printings to be made in a sort/sort and staple mode.	Reenter 10 or less for the number of printings to be made.
“Near trouble at pxx.”	A malfunction occurred in the image stabilization control or other function.	Inform the technical representative of the page number that is displayed.
“No fuser oil”	The Fuser Oil needs to be replenished and the unit is unable to produce prints.	Call your technical representative.
“No staple”	The staples have run out.	Replace the Staple Cartridge with a new one. ☞ p. 6-6
“No xxxx toner ”	Toner of the displayed color has run out and the unit is unable to produce prints.	Replenish toner. ☞ p. 6-4
“Remove papers from output bin.”	Paper that was stapled or that was not stapled remains in the Sorter.	Remove the paper from the Sorter/Staple Sorter.
“Toner waste bottle not set”	The current toner bottle is not set securely and the unit is unable to produce prints.	Call your technical representative.
“Tray trouble/mid/low.”	Either the top, middle or bottom tray cannot be used.	Check the displayed tray condition and then open and close the front door.
“Waste toner full”	The waste Toner Collecting Bottle is full and the unit is unable to produce prints.	Call your technical representative.

7. What Does Each Message Mean?

Message	Cause	Action
“Waste toner nearly full”	The current toner bottle is toner full.	Canceled when turning the power ON and OFF. Call your technical representative.
“xxxx toner nearly empty”	This message is displayed when toner will run out soon.	Replenish toner  p. 6-4

NOTE





- When initiating a print cycle from the PC and the preheat function of the CF911P is set to ON, an error is displayed. This error is automatically reset in 3-4 seconds and printing begins.
- All other messages see the section Appendix C: Troubleshooting of the User Guide.

Chapter 7

Troubleshooting

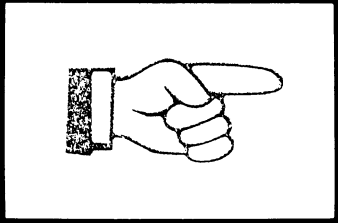
1. When This Type of Print is Produced

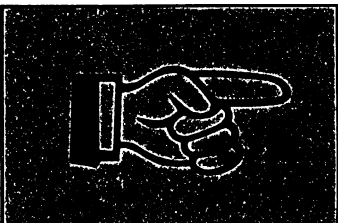
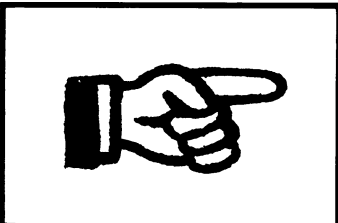
When there is a problem in the print image quantity, check both the print size and printer driver.

Print Image Condition	Possible Cause	Action
The print image is too light or the color is light.  1074O108	Is the printer driver set on the lighter side? Is the “NO TONER” message displayed on the panel? Is the print paper damp?	Check the printer driver setting. Refer to the Getting Started manual. Replenish the toner.  p. 6-4 Replace the print paper.  p. 6-2
The print image or the color is dark.  1074O109	Is the print driver set too dark?	Check the printer driver setting.
The print image is fuzzy.  1074O110	Is the print paper damp?	Replace the print paper.  p. 6-2

2. Printer Malfunctions

The printer is malfunctioning.

Printer Condition	Check for:	Action
Printing cannot be performed even if data is sent from the computer.	There is some type of malfunction.	Perform the countermeasures indicated by the messages on the display panel.
	Immediately after the main switch is turned ON, the printer remains in the warm-up mode.	After the main switch is turned ON, it takes approximately nine minutes until printing can be performed. Please wait a moment.
	The printer power is not supplied.	Check the connection cable and connection conditions.
	Are the printer port and protocol parameters set correctly in the network setup?	Check the network settings.
	Is the printer driver set correctly?	Check the name and settings of the printer driver that is used.
The printer power is not supplied.	Is the power cord disconnected from the wall outlet?	Plug the power cord securely into the wall outlet.
	Is the breaker switched OFF for the power that is supplied to the printer?	Set the breaker to ON.

If these procedures do not correct the problem, contact your Technical Representative.

Chapter 8

Miscellaneous

Miscellaneous

Chapter 8

1. Specifications

Specifications

Printer Main Unit

Type	Console type printer
Photoconductor	OPC
Printing System	Electrostatic Dry Powdered Image Transfer to Plain Paper
Developing System	Micro-Toning System
Fusing System	Lamp-Heated Roller
Resolution	400 dpi
Paper Type	Tray Feeding : Plain paper (64 to 90g/m ²), (20 lbs. to 24 lbs.) Heavy Stock 1 (91 to 105g/m ²) (24 lbs. to 28 lbs.) Manual Feeding : Plain paper (64 to 90g/m ²), (20 lbs. to 24 lbs.) Heavy Stock 1 (91 to 105g/m ²), (24 lbs. to 28 lbs.) Heavy Stock 2 (106 to 157g/m ²), (50 lbs to 60lbs. cover) OHP Transparencies (recommended by us)
Print Paper Size	Upper/Lower Trays : A3L, B4L, A4L, A4C, A5L, 8" × 13"L (203mm × 330mm), 8" × 10"L (203mm × 254mm), 8-1/4" × 13"L (210mm × 330mm) (11"×17"L, 11"×14"L, 10"×14"L, LegalL, G.LegalL, Foolscap (9-1/4"×14"L, 8-2/3"×13"L, 8-1/4"×13"L, 8-1/4"×11-3/4"L), (LetterL, LetterC, G.LetterL, G.LetterC, InvoiceL) Middle Tray : A3L, B4L, A4L, A4C, A5L (11"×17"L, LegalL, LetterL, LetterC, InvoiceL) Manual Bypass Tray : A3 Wide L (305mm × 457mm), A3L, B4L, A4L, A4C, A5L, A6L 8-1/4" × 13"L (210mm × 330mm) (12"×18"L, 11"×17"L, LegalL, LetterL, LetterC, InvoiceL) Crosswise : 148mm to 297mm (5-3/4" to 11-3/4") Lengthwise: 182mm to 432mm (7-1/4" to 17")
Tray Capacity	Upper/Lower Trays (Fixed size type) : 500 sheets (80g/m ²) (21-1/4 lbs.) Middle Tray (Universal type) : 250 sheets (80g/m ²) (21-1/4 lbs.) Manual Bypass Tray : 50 sheets (Plain Paper, Heavy Stock 1) : 20 sheets (Heavy Stock 2, OHP Transparencies)
Warm-up Time	Approx. 9 minutes at ambient temperature of 20°C/68°F
First Print Print	(in Full Size Mode using A4 crosswise paper and Upper Tray) Full-color : Less than 30 sec. Black : Less than 14 sec.
Print Speed (Approx. printings/ minute)	Full-color : 6 printings/min. (A4C) (LetterC) 3 printings/min. (A3L) (11"×17"L) 3 printings/min. (B4L) (10"×14"L) Black : 23 printings/min. (A4C) (LetterC) 11 printings/min. (A3L) (11"×17"L) 11 printings/min. (B4L) (10"×14"L)
Power Requirements	120V/60Hz, 220-240V/50-60Hz
Power Consumption	1.5 kW (Max.)
Dimensions	Width : 640mm (25-1/4") Depth : 765mm (30") Height : 994mm (39-1/4") (Up to Original Cover surface)
Space Requirement	826mm (32-1/2") (Width) × 765mm (30") (Depth)
Weight	215kg (474 lbs.)

Large Capacity Cassette C-101

Kinds of Paper	Plain paper (60 to 90g/m ²) (16 lbs. to 24 lbs.), Recycled paper
Paper Size	A4C, Letter C
Capacity	1,000 sheets (80g/m ²) (21-1/4 lbs.)
Power Source	Supplied from the printer.
Power Consumption	30W or less
Dimensions	Width : 358mm (14") Depth : 446mm (17-1/2") Height : 289mm (11-1/2")
Weight	10.7kg (23-1/2 lbs.)

10 Bin Sorter S-105

No. of Bins	1 non-sort Bin Sort Bins: 10 (From 2nd Bin to 11th Bin)
Modes	Non-Sort Mode, Sort Mode, Group Mode
Kinds of Paper	Non-Sort Mode: Plain paper (60 to 90g/m ²) (16 lbs. to 24 lbs.) Special paper (Thick paper, OHP Transparencies) Sort Mode, Group Mode: Plain paper (60 to 90g/m ²) (16 lbs. to 24 lbs.)
Paper Size	Non-Sort Mode: A3 Wide, A3L, B4L, A4L, A4C, A5L (12"×18"L, 11"×17"L to InvoiceL) Sort Mode, Group Mode: A3L, B4L, A4L, A4C, A5L (11"×17"L to Invoice)
Capacity of Bins	Non-Sort Mode Plain paper: Max 50 sheets (A3L: 80g/m ² paper) (11"×17"L / 21-1/4 lbs. paper) Special paper OHP Transparencies : 10 sheets in 1st bin (Max. paper size A4/Letter) Thick paper : 10 sheets in 1st bin Sort Mode, Group Mode Plain paper: 1st bin to 10th bin: 25 sheets/bin (80g/m ²) (21-1/4 lbs.) total 250 sheets
Power Source	24V DC Supplied from the printer.
Power Consumption	72W or less
Dimensions	Width : 400mm (15-3/4") Depth : 562mm (22-1/4") Height : 404mm (16")
Weight	15.8kg (34-3/4 lbs.) (Excluding Mounting Brackets)

1. Specifications

10 Bin Staple Sorter ST-103

No. of Bins	1 non-sort Bin Sort Bins: 10 (From 2nd Bin to 11th Bin)
Modes	Non-Sort Mode, Sort Mode, Sort-and-Staple Mode, Manual Staple Mode
Kinds of Paper	Non-Sort Mode: Plain paper (60 to 90g/m ²), (16 lbs. to 24 lbs.) Special paper (Thick paper, OHP Transparencies) Sort Mode, Sort-and Staple Mode: Plain paper (60 to 90g/m ²) (16 lbs. to 24 lbs.)
Paper Size	Non-Sort Mode : A3 Wide, A3L, B4L, A4L, A4C, A5L (12"×18"L, 11"×17"L to InvoiceL) Sort Mode : A3L, B4L, A4L, A4C, A5L (11"×17"L to InvoiceL) Sort-and-Staple Mode: A3L, B4L, A4L, A4C (11"×17"L to LetterC)
Capacity of Bins	Non-Sort Mode Plain paper: Max 50 sheets (A3L: 80g/m ² paper) (11"×17"L/21-1/4 lbs. paper) Special paper OHP Transparencies : 10 sheets in 1st bin (Max. paper size A4/Letter) Thick Paper : 10 sheets in 1st bin Sort Mode, Sort-and-Staple Mode Plain paper: 1st bin to 10th bin: 25 sheets/bin (80g/m ²) (21-1/4 lbs) total 250 sheets
Staple Capacity	2 to 25 sheets (80g/m ²) (21-1/4 lbs.)
Power Source	24V DC Supplied from the printer, synchronized from the printer main switch.
Power Consumption	72W or less
Dimensions	Width : 400mm (15-3/4") Depth : 562mm (22-1/4") Height : 404mm (16")
Weight	18.1kg (40 lbs.) (Excluding Mounting Brackets)
Accessories	Staple Cartridge, 5,000 staples/cartridge × 1 piece

Duplex Unit AD-7

Kinds of Paper	Plain paper: 60 to 90g/m ² (16 lbs. to 24 lbs.)
Print Paper Size	A3L to A5L (11"×17"L to InvoiceL)
Capacity	1-sided Up to 99 printings (A4C, A5L) (LetterC, InvoiceL) Up to 2 printings (A3L, A4L) (11"×17"L, LegalL, LetterL) 2-sided Up to 2 printings (A4C, A5L) (LetterC, InvoiceL) Up to 2 printings (A3L, B4L, A4L) (11"×17"L, LegalL, LetterL) Book: 99 prints
Power Source	DC24V, ±5% supplied from printer
Power Consumption	30W or less
Dimensions	Width : 121mm (4-3/4") Depth : 536mm (21") Height : 345mm (31-1/2")
Weight	7.0kg (15-1/2 lbs.) (Excluding Mounting Brackets)

2. Care of the Unit

Cleaning

Turn the Printer Power Switch OFF when cleaning.

Housing

Wipe the surface of the Housing clean with a soft cloth dampened with mild home detergent.

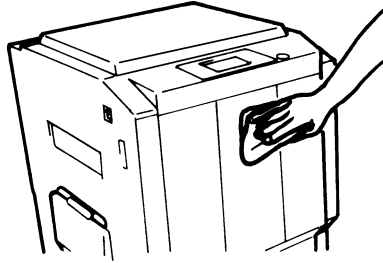

C41190021AA

Front Door

Wipe the inside of the Front Door clean with a soft, dry cloth.

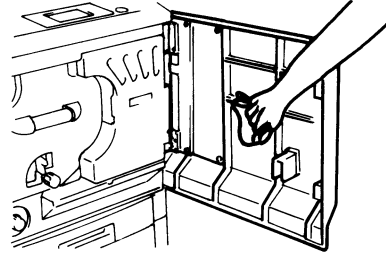

11440027AA

Operation Panel

Wipe the surface of the Operation Panel clean with a soft, dry cloth.

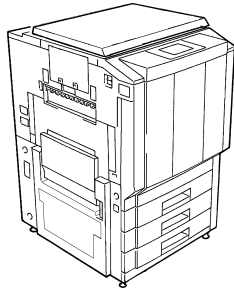

41190001

NOTE

Never use a glass cleaner or any other detergent to avoid damage to the operation keys and Operation Panel.

3. Paper Size Table

Name	Size (Metric)	Size (Inch)
A3	297 mm × 420 mm	11-3/4" × 16-1/2"
B4	257 mm × 364 mm	10" × 14-1/4"
A4	210 mm × 297 mm	8-1/4" × 11-3/4"
B5	182 mm × 257 mm	7-1/4" × 10"
A5	148 mm × 210 mm	5-3/4" × 8-1/4"
B6	128 mm × 182 mm	5" × 7-1/4"
A6	105 mm × 148 mm	4-1/4" × 5-3/4"
POST CARD	100 mm × 148 mm	4" × 5-3/4"

Name		Size (Inch)	Size (Metric)
LEDGER		11" × 17"	279 mm × 432 mm
11" × 14"		11" × 14"	279 mm × 356 mm
COMPUTER		10-1/8" × 14"	257 mm × 356 mm
10" × 14"		10" × 14"	254 mm × 356 mm
9-1/4" × 14"		9-1/4" × 14"	236 mm × 356 mm
LEGAL		8-1/2" × 14"	216 mm × 356 mm
FOOLSCAP	GOVERNMENT LEGAL	8-1/2" × 13"	216 mm × 330 mm
FOOLSCAP		8" × 13"	203 mm × 330 mm
FOOLSCAP		8-2/3" × 13"	220 mm × 330 mm
FOOLSCAP	FOLIO	8-1/4" × 13"	210 mm × 330 mm
8-1/4" × 11-3/4"		8-1/4" × 11-3/4"	210 mm × 301 mm
LETTER		8-1/2" × 11"	216 mm × 279 mm
GOVERNMENT LETTER		8" × 10-1/2"	203 mm × 267 mm
QUARTO		8" × 10"	203 mm × 254 mm
STATEMENT	INVOICE	5-1/2" × 8-1/2"	140 mm × 216 mm

4. Index

Index

- ◀ Key p. 2-6
- ▶ Key p. 2-6
- ▲ Key p. 2-6
- ▼ Key p. 2-6

10/100 Base-T p. 2-4

A

AD-7 pp. 2-2, 8-5

C

C-101 p. 8-3
 Cancel Key p. 2-7
 Cassette Door p. 2-5
 Cassette Release Lever p. 2-5
 Cleaning p. 8-6
 Computer Connection p. 2-7
 Connector p. 2-4
 Crosswise p. ix

D

Duplex Unit pp. 2-2, 6-8, 6-13, 8-5

E

Environment p. 1-3
 Ethernet p. 2-4
 Exit Tray p. 2-3

F

Feeding Direction p. ix
 Front Door pp. 2-3, 6-4, 6-9, 8-6
 Function pp. 2-6, 3-3
 Function Menu p. 5-2
 Fuser Oil p. 6-15
 Fuser Oil Near Empty p. 6-14
 Fusing Unit p. 6-10

H

Housing p. 8-6

I

IEEE1284 p. 2-4
 Inside p. 2-4
 Installing the Printer p. 1-2

L

Large Capacity Cassette pp. 2-2, 2-5, 6-3, 6-8, 6-12, 8-3
 Left Door p. 6-9
 Length p. ix
 Lengthwise p. ix
 LOAD IN ANY TRAY p. 6-2
 Lower Tray pp. 2-3, 6-2

M

Main Menu pp. 4-2, 5-2
 Manual Bypass Tray pp. 2-3, 6-8, 6-11
 Message p. 6-1
 Message LED p. 2-6
 Middle Tray pp. 2-3, 6-2, 6-3
 Miscellaneous p. 8-1
 Misfeed Location p. 6-8
 Moving p. 1-3

N

Near Trouble p. 6-16
 Network Setup p. 4-3
 No Staple p. 6-6
 No Toner p. 6-4

O

Online Key p. 2-6
 Operation p. 5-3
 Operation panel p. 2-3, 2-6, 8-6
 Options p. 2-5
 Outside p. 2-3

P

Paper Loading p. 6-2
 Paper Plate Descent Key p. 2-5
 Paper Size p. 8-7
 Paper Tray pp. 2-3, 6-2, 6-8, 6-11
 Parallel Connection p. 2-7
 Power Source p. 1-2
 Power Switch p. 2-3
 Print Image Condition p. 7-2
 Print Page pp. 5-2, 5-3, 5-4
 Printer Condition p. 7-3
 Printer Driver p. 3-3
 Printer Main Unit p. 8-2
 Printing p. 3-2

R

Ready LED p. 2-6
 Replacing Staple Cartridge p. 6-6
 Replenishing Toner p. 6-4
 Replenishing the Fuser Oil p. 6-14

S

S-105 pp. 2-2, 8-3
 ST-103 pp. 2-2, 8-4
 Safety Information p. iii
 Safety Label p. v
 Safety Notes p. 1-1
 Server Setup p. 4-8
 Set Key p. 2-6
 Setup Menu pp. 4-1, 4-2
 Site p. 1-2
 Sort Bins p. 2-5
 Sorter pp. 2-2, 2-5, 6-8, 6-13, 8-3
 Space p. 1-2
 Specification p. 8-2
 Staple Cartridge p. 6-6
 Staple Door p. 6-6
 Staple Sorter pp. 2-2, 2-5, 6-8, 6-13, 8-4
 Staple Sorter p. 6-6
 Stapler Door pp. 2-5, 6-6
 Storage p. 1-4
 Supplies p. 1-3
 Symbols p. ix
 System p. 2-2

T

The Fuser Oil has run out p. 6-14
 Toner Bottle p. 6-4
 Toner Hopper pp. 2-4, 6-4
 Toner Hopper Lid pp. 2-4, 6-5
 Toner near empty p. 6-4
 Transfer Film p. 6-10
 Transfer/Fusing Unit p. 6-10
 Transition Diagram p. 5-4
 Troubleshooting p. 7-1
 Turning OFF p. 2-8
 Turning ON p. 2-8

U

Unit Properly p. 1-3
 Universal p. 2-3
 Upper/Lower Tray pp. 2-3, 6-2

W

Width p. ix

Trademark:

CF911P, Minolta are trademark or resisted trademark of Minolta Co.,Ltd.

All other products or brands name are trademarks or registered trademarks of their respective holders.



MINOLTA

Copyright
1998 MINOLTA CO., LTD.
Printed in Japan

The information contained in this manual is subject to change without notice to incorporate improvements made on the product or products the manual covers.

MINOLTA CO., LTD.
Image Information Products Marketing Headquarters
3-13, 2-Chome, Azuchi-Machi, Chuo-ku, Osaka 541-8556, Japan