

K8V

User Guide



Motherboard

E1529

First Edition

February 2004

Copyright © 2004 ASUSTeK COMPUTER INC. All Rights Reserved.

No part of this manual, including the products and software described in it, may be reproduced, transmitted, transcribed, stored in a retrieval system, or translated into any language in any form or by any means, except documentation kept by the purchaser for backup purposes, without the express written permission of ASUSTeK COMPUTER INC. ("ASUS").

Product warranty or service will not be extended if: (1) the product is repaired, modified or altered, unless such repair, modification or alteration is authorized in writing by ASUS; or (2) the serial number of the product is defaced or missing.

ASUS PROVIDES THIS MANUAL "AS IS" WITHOUT WARRANTY OF ANY KIND, EITHER EXPRESS OR IMPLIED, INCLUDING BUT NOT LIMITED TO THE IMPLIED WARRANTIES OR CONDITIONS OF MERCHANTABILITY OR FITNESS FOR A PARTICULAR PURPOSE. IN NO EVENT SHALL ASUS, ITS DIRECTORS, OFFICERS, EMPLOYEES OR AGENTS BE LIABLE FOR ANY INDIRECT, SPECIAL, INCIDENTAL, OR CONSEQUENTIAL DAMAGES (INCLUDING DAMAGES FOR LOSS OF PROFITS, LOSS OF BUSINESS, LOSS OF USE OR DATA, INTERRUPTION OF BUSINESS AND THE LIKE), EVEN IF ASUS HAS BEEN ADVISED OF THE POSSIBILITY OF SUCH DAMAGES ARISING FROM ANY DEFECT OR ERROR IN THIS MANUAL OR PRODUCT.

SPECIFICATIONS AND INFORMATION CONTAINED IN THIS MANUAL ARE FURNISHED FOR INFORMATIONAL USE ONLY, AND ARE SUBJECT TO CHANGE AT ANY TIME WITHOUT NOTICE, AND SHOULD NOT BE CONSTRUED AS A COMMITMENT BY ASUS. ASUS ASSUMES NO RESPONSIBILITY OR LIABILITY FOR ANY ERRORS OR INACCURACIES THAT MAY APPEAR IN THIS MANUAL, INCLUDING THE PRODUCTS AND SOFTWARE DESCRIBED IN IT.

Products and corporate names appearing in this manual may or may not be registered trademarks or copyrights of their respective companies, and are used only for identification or explanation and to the owners' benefit, without intent to infringe.

Contents

Notices	vi
Safety information	vii
About this guide	viii
Conventions used in this guide	viii
Typography	viii
K8V specifications summary	ix

Chapter 1: Product introduction

1.1 Welcome!	1-2
1.2 Package contents	1-2
1.3 Special features	1-3
1.3.1 Product Highlights	1-3
1.3.2 Unique ASUS features	1-4
1.4 Before you proceed	1-5
1.5 Motherboard overview	1-6
1.5.1 Motherboard layout	1-6
1.5.2 Placement direction	1-7
1.5.3 Screw holes	1-7
1.6 Central Processing Unit (CPU)	1-8
1.6.1 Overview	1-8
1.6.2 Installing the CPU	1-9
1.7 System memory	1-10
1.7.1 DIMM sockets location	1-10
1.7.2 Memory configurations	1-10
1.7.3 Installing a DIMM	1-13
1.8 Expansion slots	1-13
1.8.1 Standard interrupt assignments	1-13
1.8.2 IRQ assignments for this motherboard	1-14
1.8.3 PCI slots	1-14
1.8.4 AGP slot	1-15
1.9 Jumpers	1-16
1.10 Connectors	1-18
1.10.1 Rear panel connectors	1-18
1.10.2 Internal connectors	1-19

Contents

Chapter 2: BIOS Information

2.1	Managing and updating your BIOS	2-2
2.1.1	Creating a bootable floppy disk	2-2
2.1.2	Using AFUDOS to update the BIOS	2-3
2.1.3	Using AFUDOS to copy BIOS from PC	2-4
2.1.4	Using ASUS EZ Flash to update the BIOS	2-5
2.1.5	Recovering the BIOS with CrashFree BIOS 2	2-6
2.2	BIOS Setup program	2-8
2.2.1	BIOS menu screen	2-9
2.2.2	Menu bar	2-9
2.2.3	Navigation keys	2-9
2.2.4	Menu items	2-10
2.2.5	Sub-menu items	2-10
2.2.6	Configuration fields	2-10
2.2.7	Pop-up window	2-10
2.2.8	Scroll bar	2-10
2.2.9	General help	2-10
2.3	Main menu	2-11
2.3.1	System Time	2-11
2.3.2	System Date	2-11
2.3.3	Legacy Diskette A	2-11
2.3.4	Language	2-11
2.3.5	Primary and Secondary IDE Master/Slave	2-12
2.3.6	System Information	2-13
2.4	Advanced menu	2-14
2.4.1	CPU Configuration	2-14
2.4.2	Chipset	2-19
2.4.3	Onboard Devices Configuration	2-21
2.4.4	PCI PnP	2-23
2.4.5	JumperFree Configuration	2-24
2.4.6	Instant Music Configuration	2-25
2.5	Power menu	2-26
2.5.1	Suspend Mode	2-26
2.5.2	Repost Video on S3 Resume	2-26
2.5.3	ACPI 2.0 Support	2-26
2.5.4	ACPI APIC Support	2-26
2.5.5	APM Configuration	2-27
2.5.6	Hardware Monitor	2-29

Contents

2.6	Boot menu	2-30
2.6.1	Boot Device Priority	2-30
2.6.2	Boot Settings Configuration	2-31
2.6.3	Security	2-32
2.7	Exit menu	2-34

Chapter 3: Software support

3.1	Install an operating system	3-2
3.2	Support CD information	3-2
3.2.1	Running the support CD	3-2
3.2.2	Drivers menu	3-3
3.2.3	Utilities menu	3-3
3.2.4	ASUS Contact Information	3-4
3.3	ASUS Instant Music Lite	3-5
3.4	VIA RAID configurations	3-7
3.4.1	Installing the Serial ATA (SATA) hard disks	3-7
3.4.2	Entering VIA Tech RAID BIOS Utility	3-8
3.4.3	Create Array	3-9
3.4.4	Delete Array	3-11
3.4.5	Select Boot Array	3-12
3.4.6	Serial Number View	3-12
3.5	Promise® RAID configurations	3-13
3.5.1	Install the hard disks	3-13
3.5.2	Entering the MBFastBuild™ utility	3-14
3.5.3	Creating a RAID 0 array (Performance)	3-15
3.5.4	Creating a RAID 1 array (Security)	3-16
3.5.5	Other FastBuild Utility Commands	3-18
3.6	Creating a RAID driver disk	3-20
3.7	Cool 'n' Quiet!™ Technology	3-21

Notices

Federal Communications Commission Statement

This device complies with Part 15 of the FCC Rules. Operation is subject to the following two conditions:

- This device may not cause harmful interference, and
- This device must accept any interference received including interference that may cause undesired operation.



The use of shielded cables for connection of the monitor to the graphics card is required to assure compliance with FCC regulations. Changes or modifications to this unit not expressly approved by the party responsible for compliance could void the user's authority to operate this equipment.

Canadian Department of Communications Statement

This digital apparatus does not exceed the Class B limits for radio noise emissions from digital apparatus set out in the Radio Interference Regulations of the Canadian Department of Communications.

This class B digital apparatus complies with Canadian ICES-003.

Where to find more information

Refer to the following sources for additional information and for product and software updates.

1. **ASUS Websites**

The ASUS website provides updated information on ASUS hardware and software products. The ASUS websites are listed in the ASUS Contact Information on the inside front cover.

2. **Optional Documentation**

Your product package may include optional documentation, such as warranty flyers, that may have been added by your dealer. These documents are not part of the standard package.

Safety information

Electrical safety

- To prevent electrical shock hazard, disconnect the power cable from the electrical outlet before relocating the system.
- When adding or removing devices to or from the system, ensure that the power cables for the devices are unplugged before the signal cables are connected. If possible, disconnect all power cables from the existing system before you add a device.
- Before connecting or removing signal cables from the motherboard, ensure that all power cables are unplugged.
- Seek professional assistance before using an adapter or extension cord. These devices could interrupt the grounding circuit.
- Make sure that your power supply is set to the correct voltage in your area. If you are not sure about the voltage of the electrical outlet you are using, contact your local power company.
- If the power supply is broken, do not try to fix it by yourself. Contact a qualified service technician or your retailer.

Operation safety

- Before installing the motherboard and adding devices on it, carefully read all the manuals that came with the package.
- Before using the product, make sure all cables are correctly connected and the power cables are not damaged. If you detect any damage, contact your dealer immediately.
- To avoid short circuits, keep paper clips, screws, and staples away from connectors, slots, sockets and circuitry.
- Avoid dust, humidity, and temperature extremes. Do not place the product in any area where it may become wet.
- Place the product on a stable surface.
- If you encounter technical problems with the product, contact a qualified service technician or your retailer.

About this guide

Conventions used in this guide

To make sure that you perform certain tasks properly, take note of the following symbols used throughout this manual.



WARNING: Information to prevent injury to yourself when trying to complete a task.



CAUTION: Information to prevent damage to the components when trying to complete a task.



IMPORTANT: Information that you **MUST** follow to complete a task.



NOTE: Tips and additional information to aid in completing a task.

Typography

Bold text	Indicates a menu or an item to select.
<i>Italics</i>	Used to emphasize a word or a phrase.
<Key>	Keys enclosed in the less-than and greater-than sign indicates that you must press the enclosed key. Example: <Enter> indicates that you must press the Enter or Return key.
<Multiple key names>	If you must press two or more keys simultaneously, the key names are linked with a plus sign (+). Example: <Ctrl+Alt+D>
Command	Means that you must enter the command exactly as shown then supply the appropriate values that appear in brackets. Example: At the DOS prompt, type the command line: afudos /i[filename] In this example, you must supply a filename for [filename]. afudos /iK8VB.ROM

K8V specifications summary

CPU	Socket 754 for AMD Athlon™ 64 processor with built-in 1MB L2 cache AMD 64 architecture that enables simultaneous 32-bit and 64-bit computing
Chipset	VIA K8T800 VIA VT8237
System Bus	800 MHz
Memory	3 x 184-pin DDR DIMM sockets for up to 3GB unbuffered ECC and non-ECC PC3200/PC2700/PC2100/PC1600 SDRAM memory
Expansion slots	1 x AGP 8X/4X 5 x PCI
Storage	South Bridge supports <ul style="list-style-type: none"> - 2 x UltraATA 133 connectors - 2 x SATA with RAID 0, RAID 1 Promise® 20376 RAID controller <ul style="list-style-type: none"> - 1 x UltraDMA133/100/66 connector - 2 x Serial ATA connectors - RAID 0 and RAID 1 configurations
Audio	ADI AD1980 SoundMAX® 6-channel audio Codec support for S/PDIF out interface
LAN	Marvell® 88E8001 Gigabit LAN controller
USB	Maximum of eight (8) USB 2.0 ports
Overclocking Features	Memory and VLink voltage adjustable SFS (Stepless Frequency Selection) from 200 MHz up to 300 MHz at 1 MHz increment Adjustable FSB/DDR ratio ASUS JumperFree ASUS C.P.R. (CPU Parameter Recall)
Special features	ASUS AI NET ASUS C.P.R. (CPU Parameter Recall) ASUS EZ Flash ASUS CrashFree BIOS2 ASUS MyLogo2™ ASUS Instant Music Lite ASUS Q-Fan Cool 'n' Quiet!™ Technology Support S/PDIF out interface

(continued on the next page)

K8V specifications summary

Back panel I/O	<ul style="list-style-type: none"> 1 x Parallel port 1 x Serial port 1 x PS/2 keyboard port 1 x PS/2 mouse port 4 x USB 2.0 ports 1 x S/PDIF out 1 x RJ-45 port Line In/Line Out/Microphone ports
Internal I/O	<ul style="list-style-type: none"> 2 x USB 2.0 connector for 4 additional USB ports CPU/Chassis fan connectors 20-pin/4-pin ATX 12V power connectors CD/AUX connectors S/PDIF out connector GAME/MIDI connector
BIOS features	<ul style="list-style-type: none"> 4Mb Flash EEPROM AMI BIOS with enhanced ACPI, PnP, DMI2.0, ASUS EZ Flash, ASUS MyLogo2, ASUS Q-Fan, SM BIOS 2.3, Multi-Language BIOS, CrashFree BIOS 2
Industry standard	PCI 2.2, USB 2.0/1.1
Manageability	WOL by PME, WOR by PME
Power Requirement	ATX power supply (with 4-pin 12V plug)
Form Factor	ATX form factor: 12 in x 9.6 in (30.5 cm x 24.4 cm)
Support CD contents	<ul style="list-style-type: none"> Device drivers ASUS PC Probe Trend Micro™ PC-cillin™ 2002 anti-virus software

* Specifications are subject to change without notice.

Chapter 1

This chapter describes the features of the motherboard. It includes brief descriptions of the motherboard components, and illustrations of the layout, jumper settings, and connectors.

Product introduction

1.1 Welcome!

Thank you for buying the ASUS® K8V motherboard!

The motherboard delivers a host of new features and latest technologies making it another standout in the long line of ASUS quality motherboards!

The motherboard combines the powers of the AMD Athlon™ 64 processor and the VIA K8T800 chipset to set a new benchmark for an effective desktop platform solution.

Supporting up to 3GB of system memory with PC3200/PC2700/PC2100/PC1600 DDR SDRAM, high-resolution graphics via an AGP 8X slot, Dual Serial ATA RAID, USB 2.0, and 6-channel audio features, the motherboard takes you ahead in the world of power computing!

Before you start installing the motherboard, and hardware devices on it, check the items in your package with the list below.

1.2 Package contents

Check your motherboard package for the following items.

- ✓ ASUS K8V motherboard
- ✓ ASUS motherboard support CD
- ✓ 2 x Ultra DMA 133/100/66 cables
- ✓ 2 x Serial ATA cables
- ✓ 1 x IDE cable
- ✓ 1 x Floppy disk cable
- ✓ I/O shield
- ✓ Bag of extra jumper caps
- ✓ User guide



If any of the above items is damaged or missing, contact your retailer.

1.3 Special features

1.3.1 Product Highlights

Latest processor technology



The AMD Athlon™ 64 desktop processor is based on AMD's 64-bit architecture, which represents the landmark introduction of the industry's first x86-64 technology. This processor provides a dramatic leap forward in compatibility, performance, investment protection, and reduced total cost of ownership and development.

HyperTransport™ Technology



HyperTransport™ Technology is a high-speed, low latency, point-to-point link designed to increase the communication speed between integrated circuits in computers, networking and telecommunications equipment up to 48 times faster than other existing technologies.

Cool 'n' Quiet!™ Technology

The motherboard supports the AMD® Cool 'n' Quiet!™ Technology that dynamically and automatically changes the CPU speed, voltage and amount of power depending on the task the CPU performs.

Serial ATA solution



The motherboard supports four interfaces compliant to the Serial ATA (SATA) specification, an evolutionary replacement of the Parallel ATA storage interface. The Serial ATA specification allows for thinner, more flexible cables with lower pin count, reduced voltage requirement, up to 150 MB/s data transfer rate.

Dual SATA RAID

The motherboard provides two high-performance Serial ATA RAID controllers that enhances hard disk performance and data back-up protection without the cost of additional RAID cards. The Promise® 20376 RAID controller incorporates two Serial ATA and one parallel connector with RAID 0 and RAID 1 functions while the onboard VIA® VT8237 RAID controller provides an additional two Serial ATA connectors for RAID 0 and RAID 1 functions.

AGP 8X support



AGP 8X (AGP 3.0) is the VGA interface specification that enables enhanced graphics performance with maximum bandwidth speeds of up to 2.12 GB/s.

S/PDIF out



The motherboard's S/PDIF out function turns your computer into a high-end entertainment system with digital connectivity to powerful speaker systems.

USB 2.0 technology



The motherboard implements the new Universal Serial Bus (USB) 2.0 specification, extending the connection speed from 12 Mbps on USB 1.1 to a fast 480 Mbps on USB 2.0 - supporting up to eight USB 2.0 ports. The higher bandwidth of USB 2.0 allows connection of devices such as high resolution video conferencing cameras, next generation scanners and printers, and fast storage units. USB 2.0 is backward compatible with USB 1.1.

6-Channel Audio solution



The motherboard uses an onboard audio CODEC that lets you enjoy high-quality 6-channel audio without having to buy advanced sound cards.

1.3.2 Unique ASUS features

AI NET solution



The Marvell® 88E8001 Gigabit PCI LAN controller chipset is onboard to provide a single-chip solution for LAN on Motherboard (LOM) applications. The controller integrates 32-bit 10/100/1000BASE-T Gigabit Ethernet Media Access Control (IEEE 802.3 compliant) and Physical Layer Transceiver solution to support high performance network applications. The controller is equipped with the net-diagnosing utility VCT (Virtual Cable Tester), that intelligently diagnoses and reports cable faults from a remote location up to 100 meters. This feature helps maintain a more stable network connection.

ASUS Q-Fan technology



The ASUS Q-Fan technology smartly adjusts the fan speeds according to the system loading to ensure quiet, cool, and efficient operation. See page 2-29.

CrashFree BIOS 2



This feature allows you to restore the original BIOS data from the ASUS support CD in case when the BIOS codes and data are corrupted. This protection eliminates the need to buy a replacement ROM chip. See page 2-6.

C.P.R. (CPU Parameter Recall)



The C.P.R. feature of the motherboard BIOS allows automatic re-setting to the BIOS default settings in case the system hangs due to overclocking. When the system hangs due to overclocking, C.P.R. eliminates the need to open the system chassis and clear the RTC data. Simply shut down and reboot the system, and BIOS automatically restores the CPU previous setting for each parameter.

ASUS MyLogo2™



This new feature present in the motherboard allows you to personalize and add style to your system with customizable boot logos. See pages 2-31.

ASUS EZ Flash BIOS



With the ASUS EZ Flash, you can easily update the system BIOS even before loading the operating system. No need to use a DOS-based utility or boot from a floppy disk. See page 2-5.

Instant Music Lite



This unique feature allows you to playback audio CDs even without booting the system to Windows®. Just press the ASUS Instant Music special function keys and enjoy the music! See details on pages 2-25 and 3-5.

1.4 Before you proceed

Take note of the following precautions before you install motherboard components or change any motherboard settings.



1. Unplug the power cord from the wall socket before touching any component.
2. Use a grounded wrist strap or touch a safely grounded object or to a metal object, such as the power supply case, before handling components to avoid damaging them due to static electricity.
3. Hold components by the edges to avoid touching the ICs on them.
4. Whenever you uninstall any component, place it on a grounded antistatic pad or in the bag that came with the component.
5. Before you install or remove any component, ensure that the ATX power supply is switched off or the power cord is detached from the power supply. Failure to do so may cause severe damage to the motherboard, peripherals, and/or components.

Onboard LED

The motherboard comes with a stand-by power LED. When lit, this green LED indicates that the system is ON, in sleep mode, or in soft-off mode, a reminder that you should shut down the system and unplug the power cable before removing or plugging in any motherboard component. The illustration below shows the location of the onboard LED.

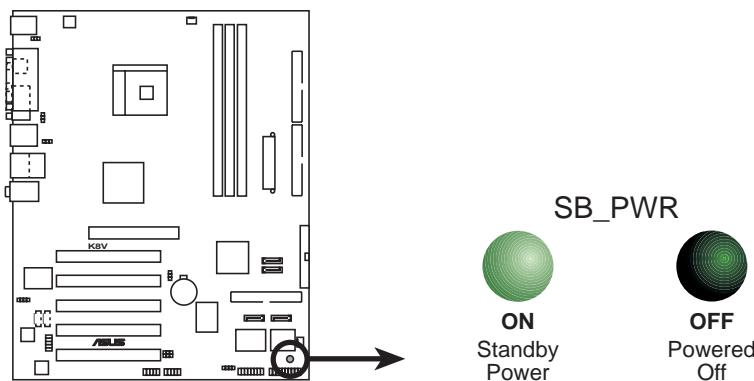

K8V Onboard LED

1.5 Motherboard overview

1.5.1 Motherboard layout

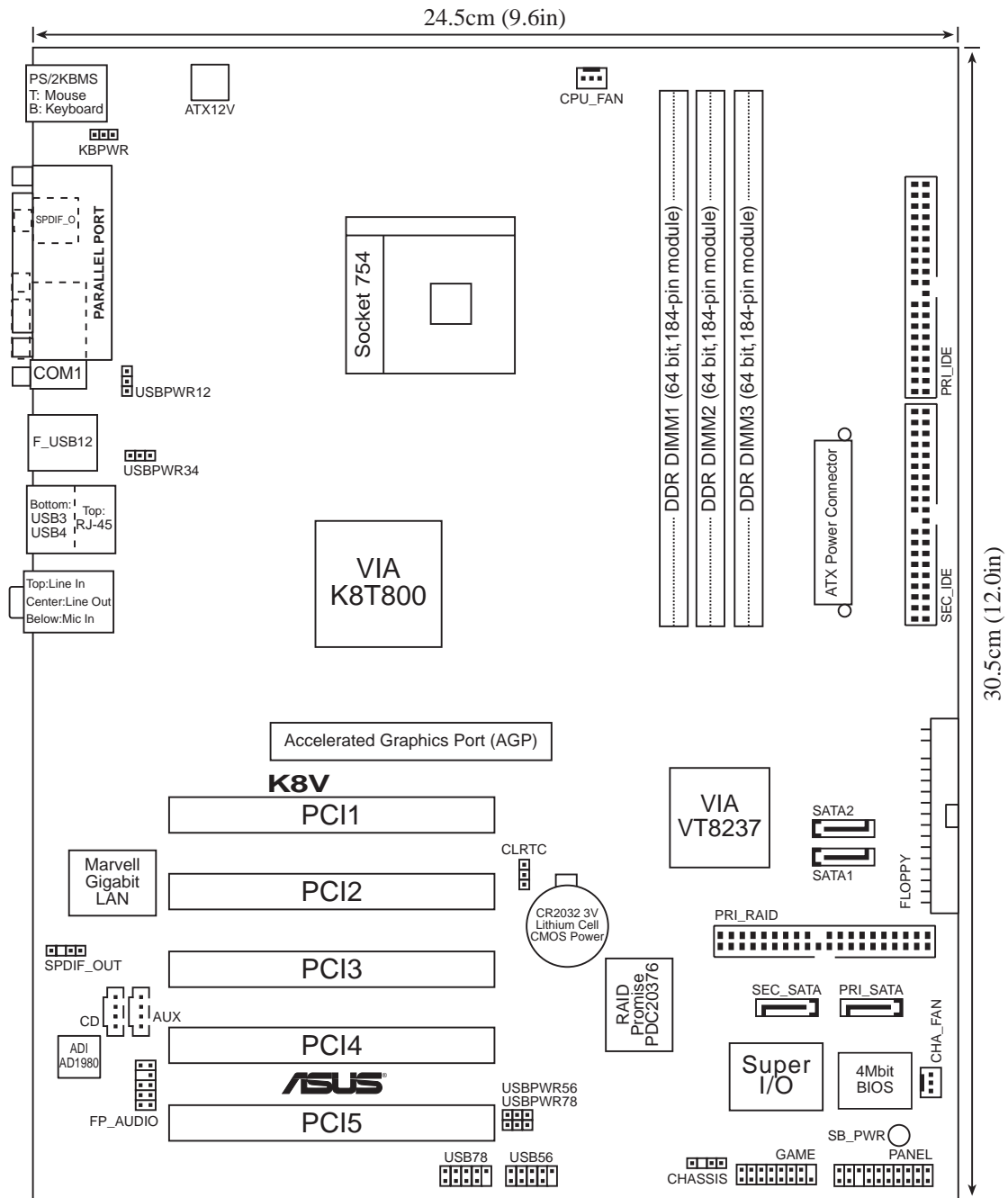

1.5.2 Placement direction

When installing the motherboard, make sure that you place it into the chassis in the correct orientation. The edge with external ports goes to the rear part of the chassis as indicated in the image below.

1.5.3 Screw holes

Place nine (9) screws into the holes indicated by circles to secure the motherboard to the chassis.



Do not overtighten the screws! Doing so may damage the motherboard.

Place this side towards
the rear of the chassis

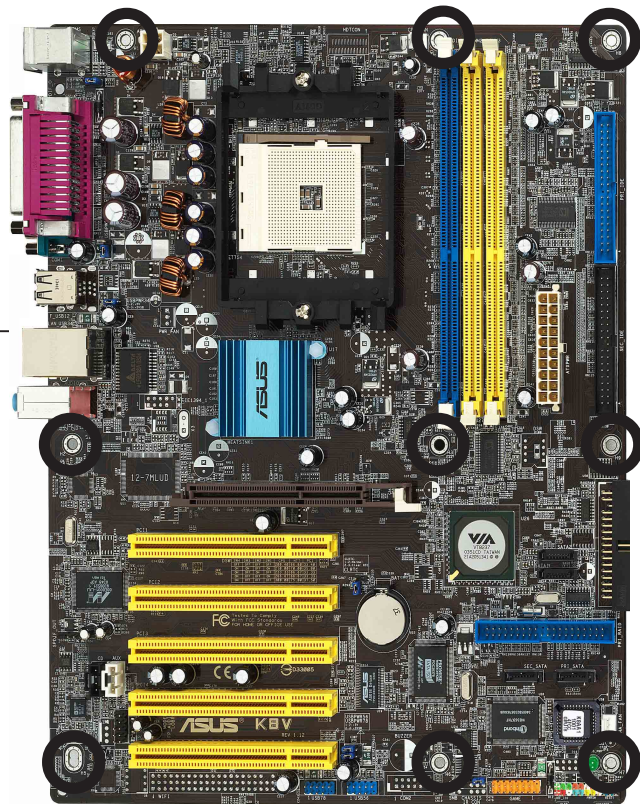

1.6 Central Processing Unit (CPU)

1.6.1 Overview

The motherboard comes with a surface mount 754-pin Zero Insertion Force (ZIF) socket designed for the AMD Athlon™ 64 processor.

The 128-bit-wide data paths of these processors can run applications faster than processors with only 32-bit or 64-bit wide data paths.

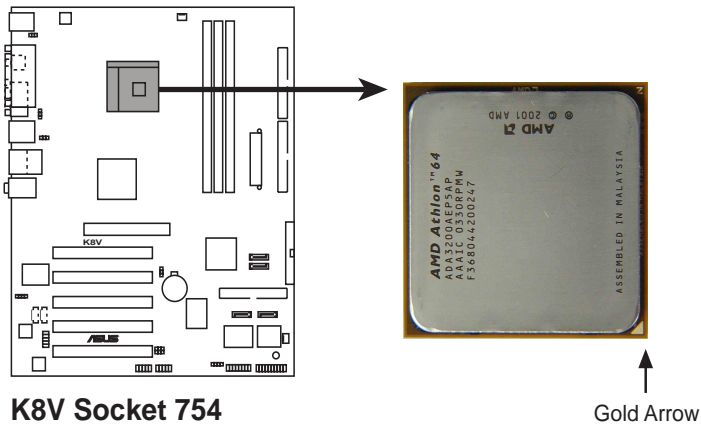

Incorrect installation of the CPU into the socket may bend the pins and severely damage the CPU!

1.6.2 Installing the CPU

Follow these steps to install a CPU.

1. Locate the 754-pin ZIF socket on the motherboard.
2. Unlock the socket by pressing the lever sideways, then lift it up to a 90°-100° angle.

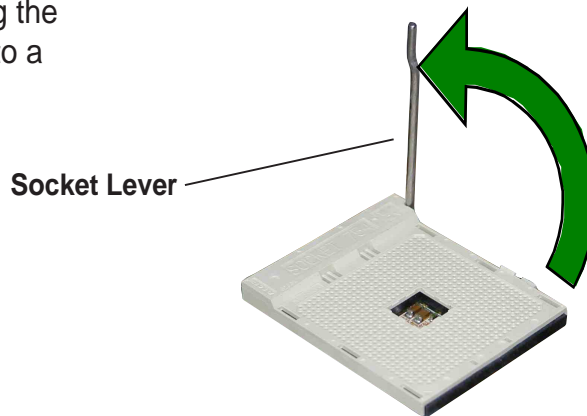

Make sure that the socket lever is lifted up to 90°-100° angle, otherwise the CPU does not fit in completely.

3. Position the CPU above the socket such that the CPU corner with the gold triangle matches the socket corner with a small triangle.
4. Carefully insert the CPU into the socket until it fits in place.

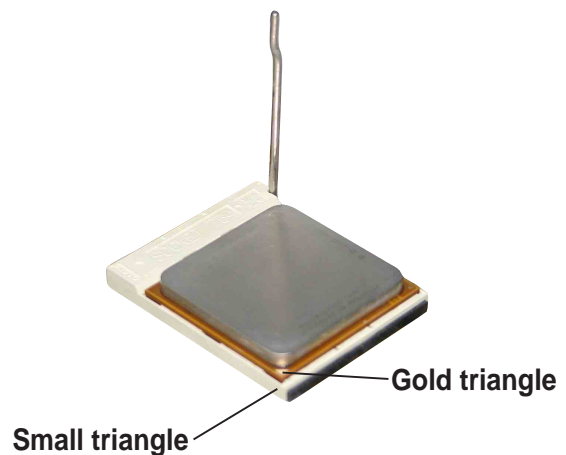

The CPU fits only in one correct orientation. DO NOT force the CPU into the socket to prevent bending the pins and damaging the CPU!

5. When the CPU is in place, push down the socket lever to secure the CPU. The lever clicks on the side tab to indicate that it is locked.
6. Install specifically designed heatsink and fan assembly.

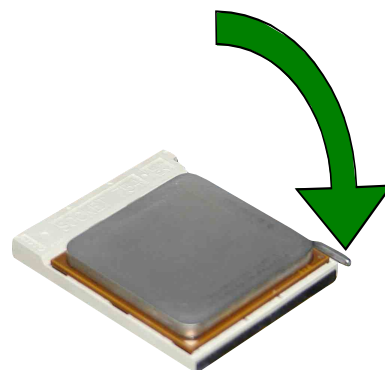

1.7 System memory

1.7.1 DIMM sockets location

The following figure illustrates the location of the DDR DIMM sockets.

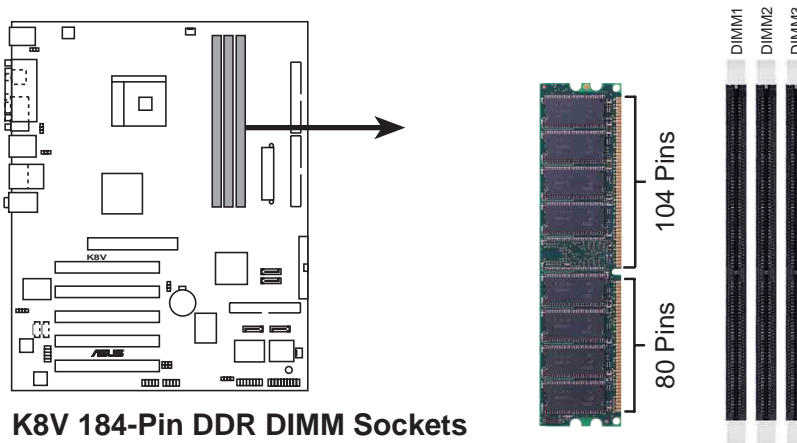

K8V 184-Pin DDR DIMM Sockets



- It is recommended to use the blue DIMM slots first.
- Make sure to unplug the power supply before adding or removing DIMMs or other system components. Failure to do so may cause severe damage to both the motherboard and the components.
- When installing long AGP cards, it is recommended to install the memory modules first. Long AGP cards, when installed, may interfere with the memory sockets.

1.7.2 Memory configurations

You may install 64MB, 128MB, 256MB, 512MB, and 1GB DDR DIMMs into the DIMM sockets using the memory configurations in this section.

Important notes



- Installing DDR DIMMs other than the recommended configurations may cause memory sizing error or system boot failure. Use any of the recommended configurations in Table 1.
- For optimum compatibility, obtain memory modules from qualified vendors. See Qualified Vendors List on page 1-12.
- Use the blue DIMM slot first.
- Stacked RAM and DDR DIMM modules with more than 18 chips are not supported.
- Always install DIMMs with the same CAS Latency. For optimum compatibility, obtain memory modules from the same vendors. See Qualified Vendors List on page 1-12.

Table 1 Recommended memory configurations

Number of DIMMs	DIMM Slot			Max Speed
	DIMM1	DIMM2	DIMM3	
1	Single Side	-	-	DDR 400
1	-	Single Side	-	DDR 400
1	-	-	Single Side	DDR 400
1	Double Side	-	-	DDR 400
1	-	Double Side	-	DDR 400
1	-	-	Double Side	DDR 400
2	Single Side	Single Side	-	DDR 400
2	Single Side	Double Side	-	DDR 400
2	Single Side	-	Single Side	DDR 400
2	Single Side	-	Double Side	DDR 400
2	Double Side	Single Side	-	DDR 400
2	Double Side	Double Side	-	DDR 400
2	Double Side	-	Single Side	DDR 400
2	-	Single Side	Single Side	DDR 333
2	-	Single Side	Double Side	DDR 200
2	-	Double Side	Single Side	DDR 200
2	-	Double Side	Double Side	DDR 200
2	Double Side	-	Double Side	DDR 400
3	Single Side	Single Side	Single Side	DDR 333
3	Single Side	Single Side	Double Side	DDR 200
3	Single Side	Double Side	Single Side	DDR 200
3	Single Side	Double Side	Double Side	DDR 200
3	Double Side	Single Side	Single Side	DDR 333
3	Double Side	Single Side	Double Side	DDR 200
3	Double Side	Double Side	Single Side	DDR 200
3	Double Side	Double Side	Double Side	DDR 200

DDR Qualified Vendor List

The following table lists the PC3200 (DDR400) memory modules that have been tested and qualified for use with this motherboard.

Table 2 DDR400 Qualified Vendor List (QVL)

Size	Vendor	Model	Chip Brand	SS/DS	Chip
256M	Micron	MT8VDDT3264AG-40BC4	Micron	SS	MT46V32M8TG-5BC
256M	Micron	MT8VDDT3264AG-40BC4	Micron	SS	MT46V32M8TG-5BC
512M	Micron	MT16VDDT6464AG-40BC4	Micron	DS	MT46V32M8TG-5BC
128M	Infineon	HYS64D16301GU-5-B	Infineon	SS	HYB25D256160BT-5B
256M	Infineon	HYS64D32300GU-5-B	Infineon	SS	HY25D256160BT-5B
512M	Infineon	HYS64D32300GU-5-B	Infineon	DS	HY25D256800BT-5B
256M	Infineon	HYS64D3230HU-5-C	Infineon	SS	HYB25D256800CE-5
512M	Infineon	HYS64D6320HU-5-C	Infineon	DS	HYB25D256800CE-5
512M	Samsung	M368L6432ETM-CCC	Samsung	DS	K4H560838E-TCCC
256M	ATP	AG32L64T8SQC4S	Samsung	SS	K4H560838D-TCC4
256M	Brain Power	B6U808-256M-SAM-400	Samsung	SS	K4H560838D-TCC4
512M	Brain Power	B6U808-512M-SAM-400	Samsung	DS	K4H560838D-TCC4
512M	Apacer	77.10736.464	Samsung	DS	K4H560838D-TCC4
256M	ADATA	MDOSS6F3G31YK1EZZ	Samsung	SS	K4H560838D-TCC4
128M	NANYA	NT128D64SH4B1G-5T	NANYA	SS	NT5DS16M16BT-5T
512M	NANYA	N512D64S8HB1G-5T	NANYA	DS	NT5DS32M8BT-5T
256M	Hynix	HYMD232646B8J-D43 AA	Hynix	SS	HY5DU56822BT-D43
256M	Kingston	KVR400X64C3A/256	Hynix	SS	HY5DV56822BT-D43
512M	Kingston	KVR400X64C3A/512	Hynix	DS	HY5DV56822BT-D43
512M	Winbond	W9451GCDB-5	Winbond	DS	W942508CH-5
256M	Kingston	KVR400X64C25/256	Winbond	SS	W942508BH-5
256M	ADATA	MDOWBFF3G31JB1EAE	Winbond	SS	W942508BH-5
512M	TwinMOS	M2G9J16AGATT9F081AA4T	TwinMOS	DS	TMD7608F8E50D
256M	TwinMOS	M2S9I08AFAPS9F0811A-T	PSC	SS	A2S56D30ATP
256M	KINGMAX	MPXB62D-38KT3R	KINGMAX	SS	KDL388P4EA-50
512M	KINGMAX	MPXC22D-38KT3R	KINGMAX	DS	KDL388P4EA-50A



Visit the ASUS website (www.asus.com) for the latest DDR 400 Qualified Vendor List for this motherboard.



Obtain DDR DIMMs only from ASUS qualified vendors for better system performance.

1.7.3 Installing a DIMM

Follow these steps to install a DIMM.

1. Unlock a DIMM socket by pressing the retaining clips outward.
2. Align a DIMM on the socket such that the notch on the DIMM matches the break on the socket.
3. Firmly insert the DIMM into the socket until the retaining clips snap back in place and the DIMM is properly seated.

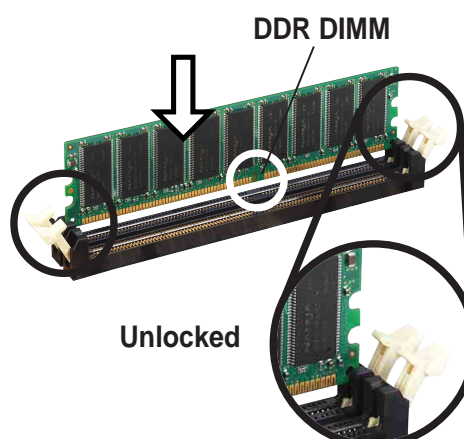

A DDR DIMM is keyed with a notch so that it fits in only one direction. DO NOT force a DIMM into a socket to avoid damaging the DIMM.

1.8 Expansion slots

To install and configure an expansion card:

1. Install an expansion card following the instructions that came with the chassis.
2. Turn on the system and change the necessary BIOS settings, if any. See Chapter 2 for BIOS information.
3. Assign an IRQ to the card. Refer to the tables next page.
4. Install the drivers and/or software applications for the expansion card according to the card documentation.

1.8.1 Standard interrupt assignments

IRQ	Priority	Standard Function
0	1	System Timer
1	2	Keyboard Controller
2	N/A	Programmable Interrupt
3*	11	IRQ holder for PCI steering
4*	12	Communications Port (COM1)
5*	13	IRQ holder for PCI steering
6	14	Floppy Disk Controller
7*	15	Printer Port (LPT1)
8	3	System CMOS/Real Time Clock
9*	4	IRQ holder for PCI steering
10*	5	IRQ holder for PCI steering
11*	6	IRQ holder for PCI steering
12*	7	PS/2 Compatible Mouse Port
13	8	Numeric Data Processor
14*	9	Primary IDE Channel
15*	10	Secondary IDE Channel

* These IRQs are usually available for ISA or PCI devices.

1.8.2 IRQ assignments for this motherboard

	INT A	INT B	INT C	INT D
PCI slot 1	shared	—	—	—
PCI slot 2	—	shared	—	—
PCI slot 3	—	—	shared	—
PCI slot 4	—	—	—	used
PCI slot 5	shared	—	—	—
Gigabit LAN	—	shared	—	—
Onboard RAID	—	—	shared	—
Serial ATA	—	—	shared	—
AGP slot	shared	—	—	—



When using PCI cards on shared slots, ensure that the drivers support “Share IRQ” or that the cards do not need IRQ assignments. Otherwise, conflicts will arise between the two PCI groups, making the system unstable and the card inoperable.

1.8.3 PCI slots

The PCI slots support PCI cards such as a LAN card, SCSI card, USB card, and other cards that comply with PCI specifications.

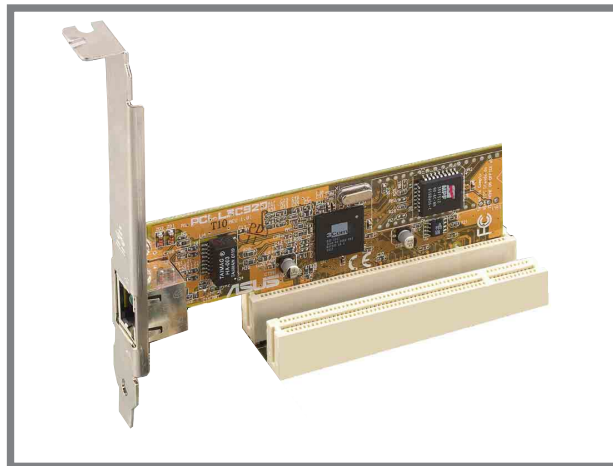

1.8.4 AGP slot

The Accelerated Graphics Port (AGP) slot supports AGP 8X/4X (+1.5V) cards. When you buy an AGP card, make sure that you ask for one with +1.5V specification.

Note the notches on the card golden fingers to ensure that they fit the AGP slot on the motherboard.



Install only +1.5V AGP cards.

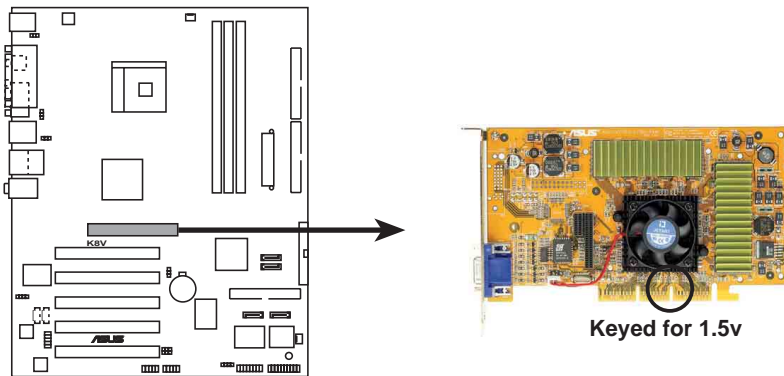

K8V Accelerated Graphics Port (AGP)



If installing the ATi 9500 or 9700 Pro Series VGA cards, use only the card version **PN xxx-xxxxx-30** or later, for optimum performance and overclocking stability.

1.9 Jumpers

1. Clear RTC RAM (CLRTC)

This jumper allows you to clear the Real Time Clock (RTC) RAM in CMOS. You can clear the CMOS memory of date, time, and system setup parameters by erasing the CMOS RTC RAM data. The RAM data in CMOS, that include system setup information such as system passwords, is powered by the onboard button cell battery.

To erase the RTC RAM:

1. Turn OFF the computer and unplug the power cord.
2. Move the jumper cap from pins 1-2 (default) to pins 2-3. Keep the cap on pins 2-3 for about 5~10 seconds, then move the cap back to pins 1-2.
3. Plug the power cord and turn ON the computer.
4. Hold down the key during the boot process and enter BIOS setup to re-enter data.



Except when clearing the RTC RAM, never remove the cap on the jumper default position. Removing the cap will cause system boot failure!

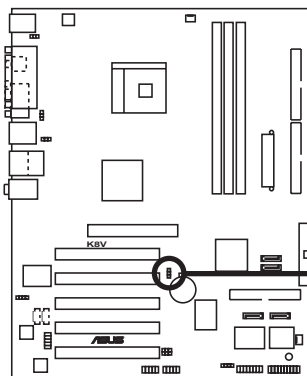

K8V Clear RTC RAM

CLRTC

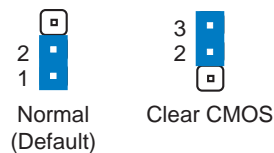

You do not need to clear the RTC when the system hangs due to overclocking. For system failure due to overclocking, use the C.P.R. (CPU Parameter Recall) feature. Shut down and reboot the system so BIOS can automatically reset parameter settings to its previous values.

2. Keyboard power (3-pin KBPWR)

This jumper allows you to enable or disable the keyboard wake-up feature. Set this jumper to pins 2-3 (+5VSB) if you wish to wake up the computer when you press a key on the keyboard. This feature requires an ATX power supply that can supply at least 1A on the +5VSB lead, and a corresponding setting in the BIOS.

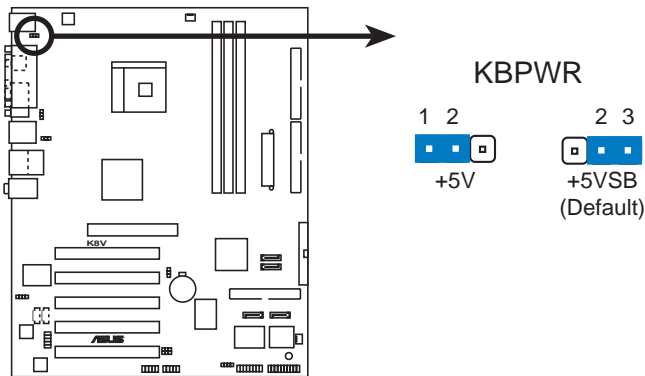

K8V Keyboard Power Setting

3. USB device wake-up (3-pin USBPWR12, USBPWR34, USBPWR56, USBPWR78)

Set these jumpers to +5V to wake up the computer from S1 sleep mode (CPU stopped, DRAM refreshed, system running in low power mode) using the connected USB devices. Set to +5VSB to wake up from S3 and S4 sleep modes (no power to CPU, DRAM in slow refresh, power supply in reduced power mode).

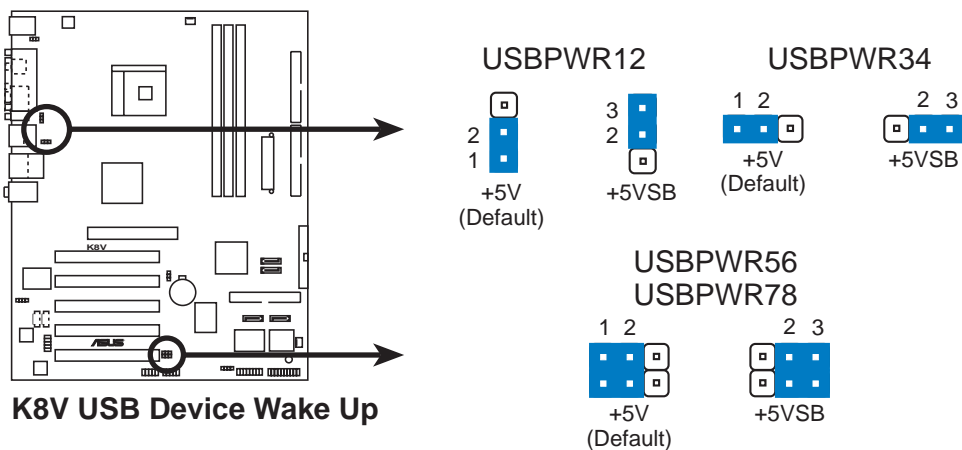

K8V USB Device Wake Up



- The USB device wake-up feature requires a power supply that can provide 500mA on the +5VSB lead for each USB port. Otherwise, the system would not power up.
- The total current consumed must NOT exceed the power supply capability (+5VSB) whether under normal condition or in sleep mode.

1.10 Connectors

This section describes and illustrates the motherboard rear panel and internal connectors.

1.10.1 Rear panel connectors

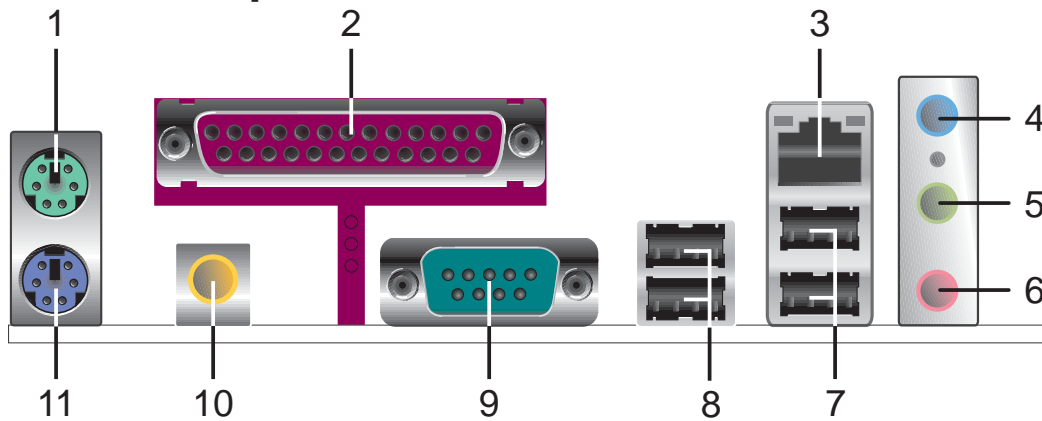

1. **PS/2 mouse port.** This green 6-pin connector is for a PS/2 mouse.
2. **Parallel port.** This 25-pin port connects a parallel printer, a scanner, or other devices.
3. **RJ-45 port.** This port allows connection to a Local Area Network (LAN) through a network hub.
4. **Line In jack.** This Line In (light blue) jack connects a tape player or other audio sources. In 6-channel mode, the function of this jack becomes Bass/Center.
5. **Line Out jack.** This Line Out (lime) jack connects a headphone or a speaker. In 6-channel mode, the function of this jack becomes Front Speaker Out.
6. **Microphone jack.** This Mic (pink) jack connects a microphone. In 6-channel mode, the function of this jack becomes Rear Speaker Out.



The functions of the Line Out, Line In, and Microphone jacks change when you select the 6-channel audio configuration as shown in the following table.

Audio 2, 4 or 6-channel configuration

	Headphone/ 2-Speaker	4-Speaker	6-Speaker
Light Blue	Line In	Line In	Bass/Center
Lime	Line Out	Front Speaker Out	Front Speaker Out
Pink	Mic In	Rear Speaker Out	Rear Speaker Out

7. **USB 2.0 ports 3 and 4.** These two 4-pin Universal Serial Bus (USB) ports are available for connecting USB 2.0 devices.
8. **USB 2.0 ports 1 and 2.** These two 4-pin Universal Serial Bus (USB) ports are available for connecting USB 2.0 devices.
9. **Serial connector.** This 9-pin COM1 port is for serial devices.
10. **S/PDIF out jack.** This jack connects to external audio output devices.
11. **PS/2 keyboard port.** This purple connector is for a PS/2 keyboard.

1.10.2 Internal connectors

1. IDE connectors (40-1 pin PRI_IDE, SEC_IDE)

This connector supports the provided UltraATA133 IDE hard disk ribbon cable. Connect the cable's blue connector to the primary (recommended) or secondary IDE connector, then connect the gray connector to the UltraATA133 slave device (hard disk drive) and the black connector to the UltraATA133 master device.



- Follow the hard disk drive documentation when setting the device in master or slave mode.
- Pin 20 on each IDE connector is removed to match the covered hole on the UltraATA cable connector. This prevents incorrect orientation when you connect the cables.
- The hole near the blue connector on the UltraATA cable is intentional.

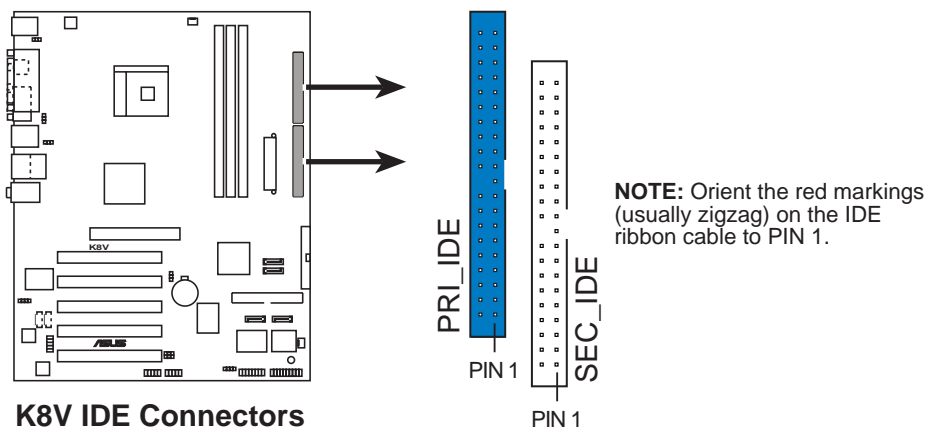

2. Floppy disk drive connector (34-1 pin FLOPPY)

This connector supports the provided floppy drive ribbon cable. After connecting one end to the motherboard, connect the other end to the floppy drive. (Pin 5 is removed to prevent incorrect insertion when using ribbon cables with pin 5 plug).

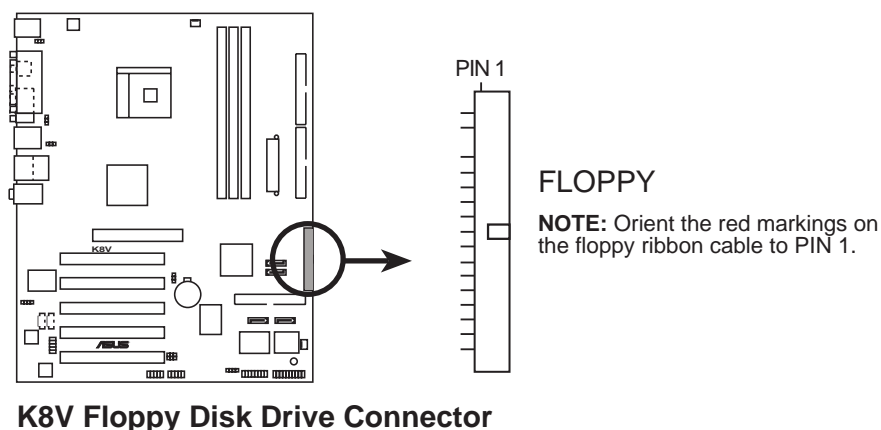

3. ATX power connectors (20-pin ATXPWR, 4-pin ATX12V)

These connectors connect to an ATX 12V power supply. The plugs from the power supply are designed to fit these connectors in only one orientation. Find the proper orientation and push down firmly until the connectors completely fit.

In addition to the 20-pin ATX power connector, this motherboard requires that you connect the 4-pin ATX +12V power plug to provide sufficient power to the CPU.



Make sure that your ATX 12V power supply can provide 8A on the +12V lead and at least 1A on the +5-volt standby lead (+5VSB). The minimum recommended wattage is 230W, or 300W for a fully configured system. The system may become unstable and may experience difficulty powering up if the power supply is inadequate.

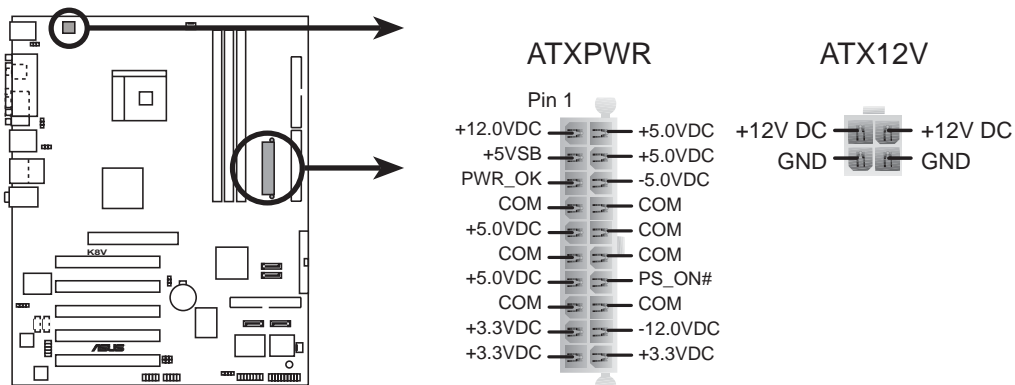

K8V ATX Power Connectors

4. Internal audio connectors (4-pin CD, AUX)

These connectors allow you to receive stereo audio input from sound sources such as a CD-ROM, TV tuner, or MPEG card.

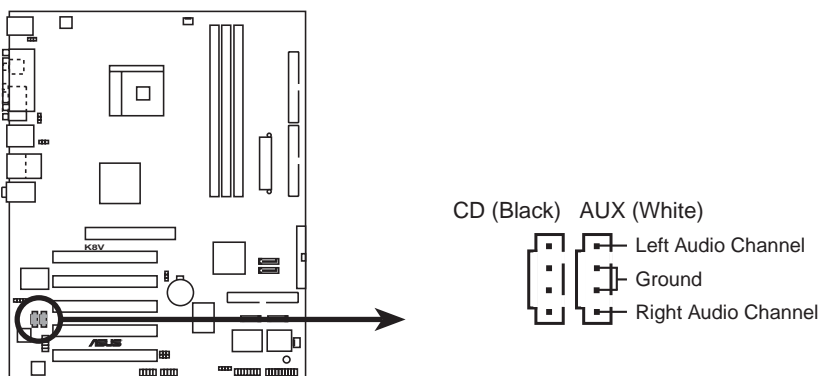

K8V Internal Audio Connectors

5. CPU and chassis fan connectors (3-pin CPU_FAN, CHA_FAN)

The fan connectors support cooling fans of 350mA~740mA (8.88W max.) or a total of 1A~2.22A (26.64W max.) at +12V. Connect the fan cables to the fan connectors on the motherboard, making sure that the black wire of each cable matches the ground pin of the connector.



Do not forget to connect the fan cables to the fan connectors. Lack of sufficient air flow within the system may damage the motherboard components. These are not jumpers! DO NOT place jumper caps on the fan connectors!

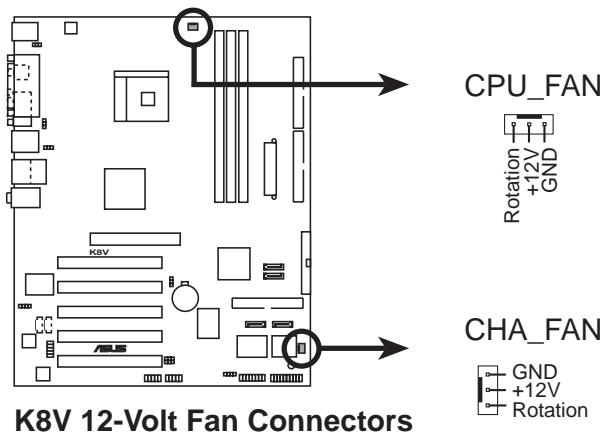

6. USB header (10-1 pin USB56, USB78)

If the USB ports on the rear panel are inadequate, a USB header is available for additional USB ports. Connect the USB cable of the USB 2.0 module to this header. You may install the USB module in the chassis front panel. The module has two USB 2.0 ports for connecting next generation USB peripherals such as high resolution cameras, scanners, and printers.

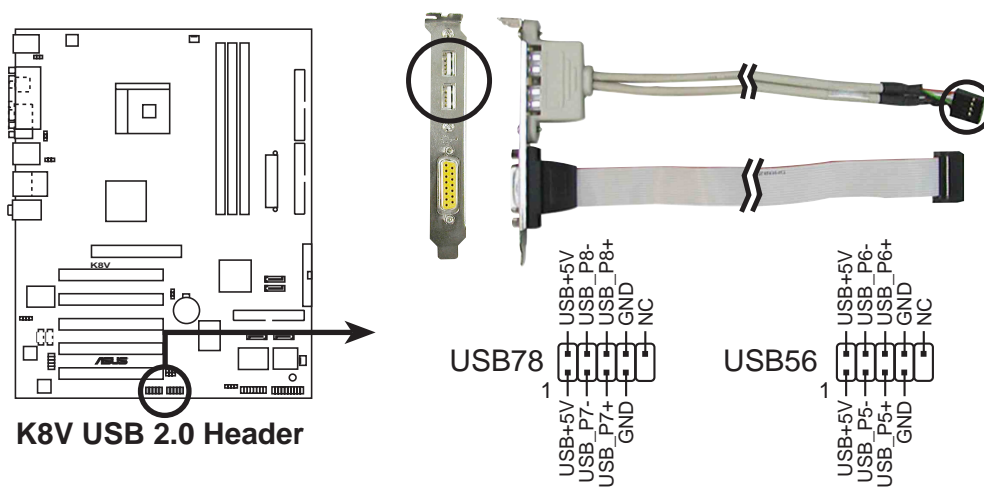

- The USB 2.0 module is purchased separately.
- Install the USB 2.0 driver before using the USB 2.0 feature.

7. Front panel audio connector (10-1 pin FP_AUDIO)

This is an interface for the front panel cable that allows convenient connection and control of audio devices.

By default, the pins labeled LINE OUT_R/BLINE_OUT_R and the pins LINE OUT_L/BLINE_OUT_L are shorted with jumper caps. Remove the caps only when you are connecting the front panel audio cable.

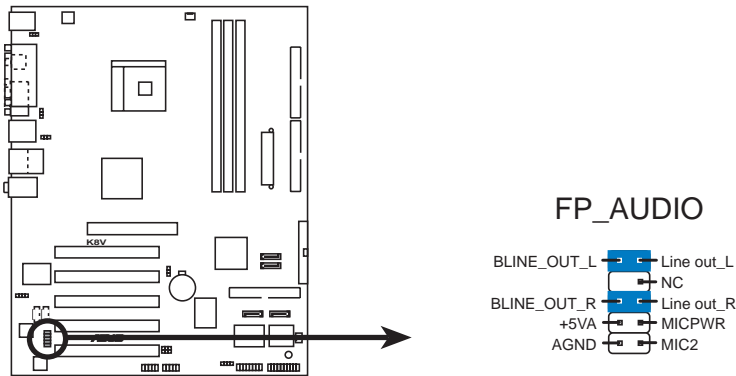

K8V Front Panel Audio Connector

8. Chassis intrusion connector (4-1 pin CHASSIS)

This lead is for a chassis designed with intrusion detection feature. This requires an external detection mechanism such as a chassis intrusion sensor or microswitch. When you remove any chassis component, the sensor triggers and sends a high-level signal to this lead to record a chassis intrusion event.

By default, the pins labeled “Chassis Signal” and “Ground” are shorted with a jumper cap. If you wish to use the chassis intrusion detection feature, remove the jumper cap from the pins.

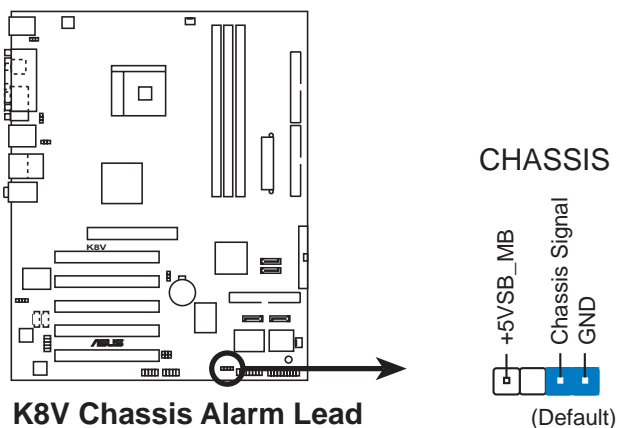

K8V Chassis Alarm Lead

9. GAME/MIDI connector (16-1 pin GAME)

This connector supports a GAME/MIDI module. If a GAME/MIDI module is available, connect the GAME/MIDI cable to this connector. The GAME/MIDI port on the module connects a joystick or a game pad for playing games, and MIDI devices for playing or editing audio files.

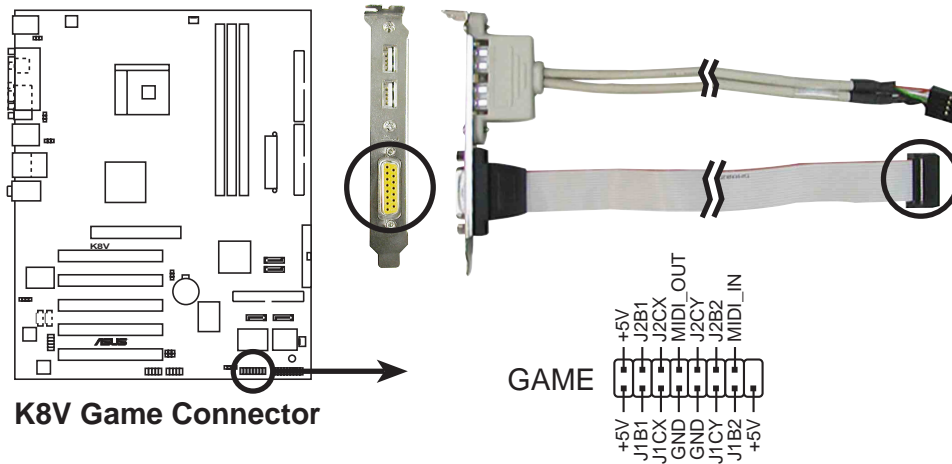

The GAME/MIDI module is purchased separately.

10. Serial ATA connectors (7-pin SATA1, SATA2)

These next generation connectors support the thin Serial ATA cables for primary internal storage devices. The current Serial ATA interface allows up to 150 MB/s data transfer rate, faster than the standard parallel ATA with 133MB/s (Ultra ATA/133).

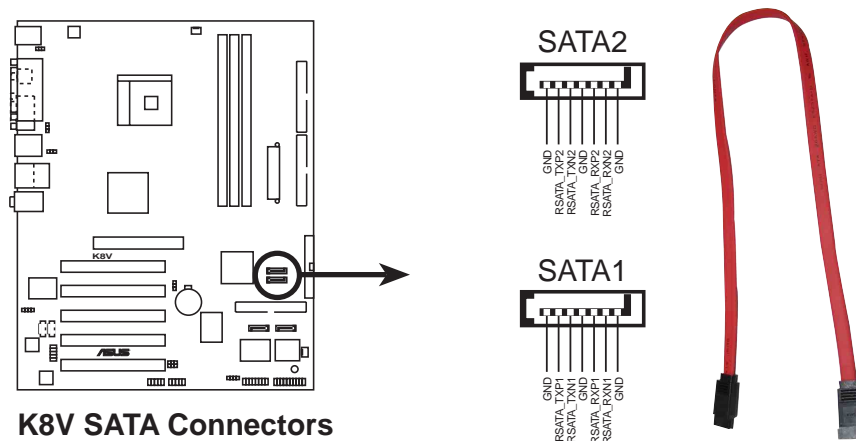

11. RAID Serial ATA connectors (7-pin PRI_SATA, SEC_SATA)

These Serial ATA connectors support SATA hard disks that you may configure as a RAID set. Through the onboard Promise® PDC20376 RAID controller, you may create a RAID 0 or RAID 1 configuration together with the RAID ATA133 connector. See Chapter 3 for details on RAID configuration.

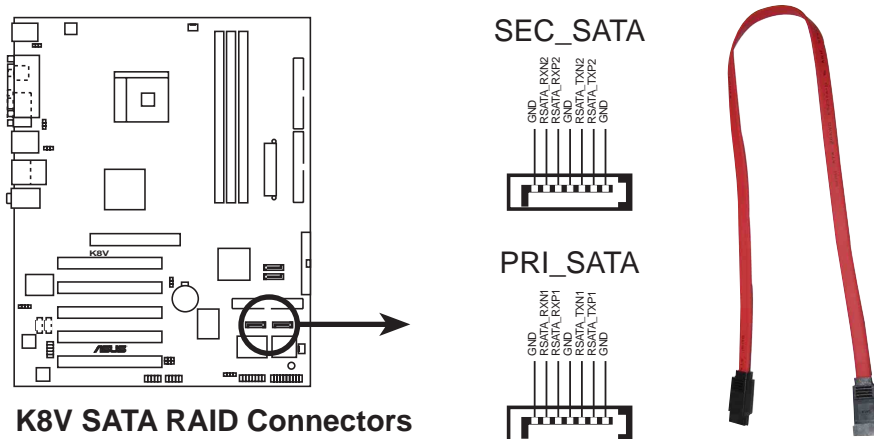

Important notes on Serial ATA solution:

- The Serial ATA cable is smaller and more flexible allowing easier routing inside the chassis. The lower pin count of the Serial ATA cable eliminates the problem caused by the wide, flat ribbon cables of the Parallel ATA interface.
- Hot plug support for Serial ATA drive and connections is not available in this motherboard.
- Install Windows® XP Service Pack 1 when using Serial ATA.
- Refer to sections “3.4 VIA RAID Configurations” or “3.5 Promise® RAID Configurations” for details on SATA RAID configuration.

12. Digital Audio connector (6-1 pin SPDIF_OUT)

This connector is for the S/PDIF audio module to allow digital sound output. Connect one end of the S/PDIF audio cable to this connector and the other end to the S/PDIF module.

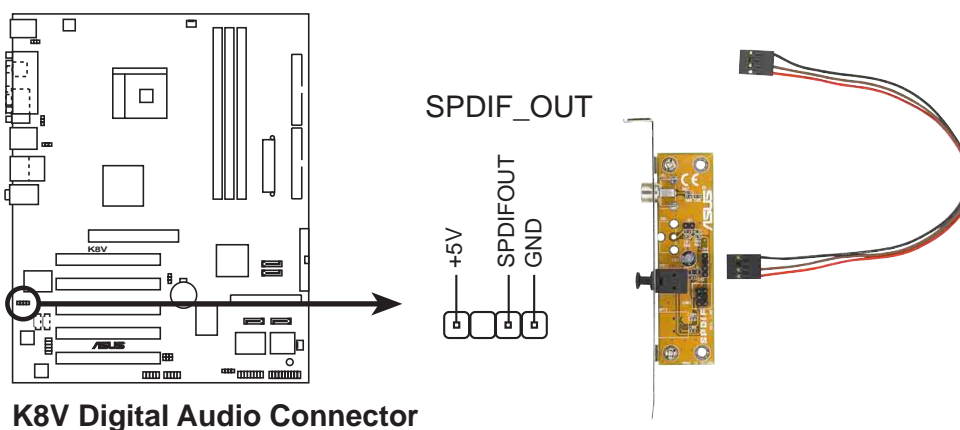

The S/PDIF out module is purchased separately.

13. System panel connector (10-1 pin PANEL)

This connector accommodates several system front panel functions.

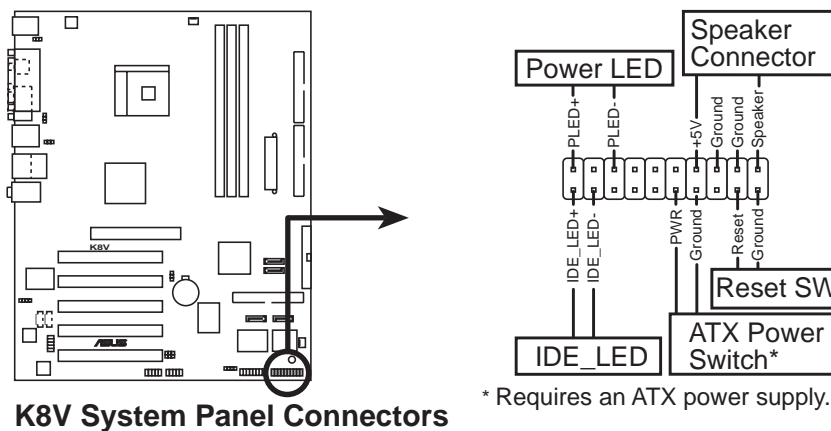

- **System Power LED Lead (Green 3-1 pin PLED)**
This 3-1 pin connector connects to the system power LED. The LED lights up when you turn on the system power, and blinks when the system is in sleep mode.
- **System Warning Speaker Lead (Orange 4-pin SPKR)**
This 4-pin connector connects to the case-mounted speaker and allows you to hear system beeps and warnings.
- **Reset Switch Lead (Blue 2-pin RESET)**
This 2-pin connector connects to the case-mounted reset switch for rebooting the system without turning off the system power.
- **ATX Power Switch / Soft-Off Switch Lead (Yellow 2-pin PWRBTN)**
This connector connects a switch that controls the system power. Pressing the power switch turns the system between ON and SLEEP, or ON and SOFT OFF, depending on the BIOS or OS settings. Pressing the power switch while in the ON mode for more than 4 seconds turns the system OFF.
- **Hard disk activity LED (Red 2-pin IDE_LED)**
This connector supplies power to the hard disk activity LED. Any read or write activity of an IDE device cause this LED to light up.



The System Panel connector is color-coded for easy and foolproof connection. Take note of the specific connector colors as described.

Chapter 2

This chapter tells how to change system settings through the BIOS Setup menus. Detailed descriptions of the BIOS parameters are also provided.

BIOS information

2.1 Managing and updating your BIOS

The following utilities allow you to manage and update the motherboard Basic Input/Output System (BIOS) setup.

1. ASUS AFUDOS - Updates the BIOS using a bootable floppy disk in DOS mode.
2. ASUS EZ Flash - Updates the BIOS using a floppy disk during POST.
3. ASUS CrashFree BIOS 2 - Updates the BIOS using a bootable floppy disk or the motherboard support CD.

Refer to the corresponding sections for details on these utilities.

Important notes



-
- It is recommended that you save a copy of the **original motherboard BIOS file** to a **bootable floppy disk** in case you need to restore the BIOS in the future. Copy the original motherboard BIOS using AFUDOS (refer to section “2.1.3 Using AFUDOS to copy BIOS from PC”)
 - Visit the ASUS website and download the latest BIOS file for this motherboard using the ASUS Update utility.
-

2.1.1 Creating a bootable floppy disk

1. Do either one of the following to create a bootable floppy disk.

DOS environment

Insert a 1.44 MB floppy disk into the drive. At the DOS prompt, type:

`format A: /S` then press **<Enter>**.

Windows® 98SE/ME/2000/XP environment

- a. Insert a 1.44 MB floppy disk into the floppy disk drive.
- b. From your Windows desktop, click on **Start**, then select **My Computer**.
- c. Select the **3 1/2 Floppy Drive** icon.
- d. Click **File** from the menu, then select **Format**. A **Format 3 1/2 Floppy Disk** window appears.
- e. If you are using Windows® XP, select **Create an MS-DOS startup disk** from the format options field, then click **Start**.

OR

If you are using Windows® 98SE/ME/2000, select **Full** option button from the format type, then click **Start**.

2. Copy the original (or the latest) motherboard BIOS to the bootable floppy disk.

2.1.2 Using AFUDOS to update the BIOS

To update the BIOS using the AFUDOS.EXE utility:

1. Visit the ASUS website (www.asus.com) to download the latest BIOS file for your motherboard. Save the BIOS file to a bootable floppy disk.



Write the BIOS file name on a piece of paper. You need to type the exact BIOS file name at the prompt.

2. Copy the AFUDOS.EXE utility from the support CD to the bootable floppy disk that contains the BIOS file.
3. Boot the system from the floppy disk.
4. At the DOS prompt, type the command line:

```
afudos /i[filename]
```

where [filename] means the latest (or original) BIOS file that you copied to the bootable floppy disk.

5. Press **<Enter>**. The succeeding screen displays the status of the update process.



The BIOS information on the screen is for reference only. What you see on your screen may not be exactly the same as shown.

```
A:\>afudos /iK8VB.ROM
AMI Firmware Update Utility - Version 1.10
Copyright (C) 2002 American Megatrends, Inc. All rights reserved.

Reading file ..... done
Erasing flash .... done
Writing flash .... 0x0008CC00 (9%)
```



DO NOT shutdown or reset the system while updating the BIOS! Doing so may cause system boot failure!

When the BIOS update process is complete, the utility returns to the DOS prompt.

```
A:\>afudos /iK8VB.ROM
AMI Firmware Update Utility - Version 1.10
Copyright (C) 2002 American Megatrends, Inc. All rights reserved.

Reading file ..... done
Erasing flash .... done
Writing flash .... 0x0008CC00 (9%)
Verifying flash .. done

A:\>
```

5. Reboot the system from the hard disk.

2.1.3 Using AFUDOS to copy BIOS from PC

You can use the AFUDOS.EXE utility to copy the current system BIOS to a floppy or hard disk and use it as a backup in case the system BIOS fails or gets corrupted.

To copy the BIOS from your PC using AFUDOS.EXE:

1. At the DOS prompt, type the command line:

```
afudos /o[filename]
```

where **[filename]** string of not more than eight (8) alpha-numeric characters for the main filename and three (3) alpha-numeric characters for the extension name.

2. Press <Enter>.



The BIOS information on the screen is for reference only. What you see on your screen may not be exactly the same as shown.

Main filename
|
|
├──
|
|
└──
|
|
└──
Extension name

```
A:\>afudos /oMYBIOS03.rom
AMI Firmware Update Utility - Version 1.10
Copyright (C) 2002 American Megatrends, Inc. All rights reserved.

Reading flash ..... 0x0008CC00 (9%)
```

3. The utility will copy the current system BIOS by default to the floppy disk. Make sure that the floppy disk has at least 600KB of free disk space and is not write-protected.

```
A:\>afudos /oMYBIOS03.ROM
AMI Firmware Update Utility - Version 1.10
Copyright (C) 2002 American Megatrends, Inc. All rights reserved.

Reading flash ..... done

A:\>
```

When the copy process is complete, the utility returns to the DOS prompt.

2.1.4 Using ASUS EZ Flash to update the BIOS

The ASUS EZ Flash feature allows you to easily update the BIOS without having to go through the long process of booting from a diskette and using a DOS-based utility. The EZ Flash is built-in the BIOS firmware so it is accessible by simply pressing **<Alt + F2>** during the Power-On Self Tests (POST).

To update the BIOS using ASUS EZ Flash:

1. Visit the ASUS website (www.asus.com) to download the latest BIOS file for your motherboard and rename the downloaded file as **K8VB.ROM**. Save the BIOS file to a floppy disk.
2. Reboot the system.
3. To launch EZ Flash, press **<Alt+F2>** during POST to display the following.

```
User recovery requested. Starting BIOS recovery...
Checking for floppy...
```



- If there is no floppy disk in the drive, the error message “Floppy not found!” appears.
- If the correct BIOS file is not in the floppy disk, the error message “Floppy not found!” is displayed. Make sure to rename the downloaded BIOS file as “K8VB.ROM”.

4. Insert the floppy disk that contains the BIOS file. If all the necessary files are found in the floppy disk, EZ Flash performs the BIOS update process and automatically reboots the system when done.



DO NOT shutdown or reset the system while updating the BIOS! Doing so may cause system boot failure!

```
User recovery requested. Starting BIOS recovery...
Checking for floppy...
Floppy found!
Reading file "K8VB.ROM". Completed.
Start flashing...
Flashed successfully. Rebooting.
```

2.1.5 Recovering the BIOS with CrashFree BIOS 2

The CrashFree BIOS 2 auto recovery tool allows you to restore BIOS from the motherboard support CD, or from a floppy disk that contains the BIOS file, in case the current BIOS on the motherboard fails or gets corrupted.



- Prepare the **support CD** that came with the motherboard or a **floppy disk that contains the motherboard BIOS** before proceeding with the BIOS update process.
- If you have saved a copy of the original motherboard BIOS to a bootable floppy disk, you may also use this disk to restore the BIOS. See section "2.1.1 Creating a bootable floppy disk."

To recover the BIOS from a floppy disk:

1. Boot the system.
2. When a corrupted BIOS is detected, the following screen message appears.

```
Bad BIOS checksum. Starting BIOS recovery...
Checking for floppy...
```

3. Insert a floppy disk that contains the original or the latest BIOS file for this motherboard. If all the necessary files are found in the floppy disk, the BIOS update process continues.



Make sure that the BIOS file in the floppy disk is renamed as "**K8VB.ROM**".

```
Bad BIOS checksum. Starting BIOS recovery...
Checking for floppy...
Floppy found!
Reading file "K8VB.ROM". Completed.
Start flashing...
```



DO NOT shut down or reset the system while updating the BIOS! Doing so may cause system boot failure!

2. When the BIOS update process is complete, reboot the system.

To recover the BIOS from the support CD:

1. Boot the system.
2. When a corrupted BIOS is detected, the following screen message appears.

```
Bad BIOS checksum. Starting BIOS recovery...
Checking for floppy...
```



If there is no floppy disk found in the drive, the system automatically checks the CD-ROM.

3. Place the support CD in the CD-ROM. The support CD contains the a working BIOS for this motherboard.

```
Bad BIOS checksum. Starting BIOS recovery...
Checking for floppy...
Floppy not found!
Checking for CD-ROM...
CD-ROM found.
Reading file "K8VB.ROM". Completed.
Start flashing...
```



DO NOT shut down or reset the system while updating the BIOS! Doing so may cause system boot failure!

2. When the BIOS update process is complete, reboot the system.



The recovered BIOS may not be the latest BIOS version for this motherboard. Visit ASUS website (www.asus.com) to download the latest BIOS file.

2.2 BIOS Setup program

This motherboard supports a programmable firmware chip that you can update using the provided utility described in section “4.1 Managing and updating your BIOS.”

Use the BIOS Setup program when you are installing a motherboard, reconfiguring your system, or prompted to “Run Setup”. This section explains how to configure your system using this utility.

Even if you are not prompted to use the Setup program, you may want to change the configuration of your computer in the future. For example, you may want to enable the security password feature or change the power management settings. This requires you to reconfigure your system using the BIOS Setup program so that the computer can recognize these changes and record them in the CMOS RAM of the firmware hub.

The firmware hub on the motherboard stores the Setup utility. When you start up the computer, the system provides you with the opportunity to run this program. Press **** during the Power-On Self Test (POST) to enter the Setup utility. Otherwise, POST continues with its test routines.

If you wish to enter Setup after POST, restart the system by pressing **<Ctrl+Alt+Delete>**, or by pressing the reset button on the system chassis. You can also restart by turning the system off and then back on. Do this last option only if the first two failed.

The Setup program is designed to make it as easy to use as possible. It is a menu-driven program, which means you can scroll through the various sub-menus and make your selections from the available options using the navigation keys.



The default BIOS settings for this motherboard apply for most conditions to ensure optimum performance. If the system becomes unstable after changing any BIOS settings, load the default settings to ensure system compatibility and stability. Select the **Load Default Settings** item under the Exit Menu. See section “2.7 Exit Menu.”



The BIOS setup screens shown in this chapter are for reference purposes only, and may not exactly match what you see on your screen.

Visit the ASUS website (www.asus.com) to download the latest product and BIOS information.

2.2.1 BIOS menu screen

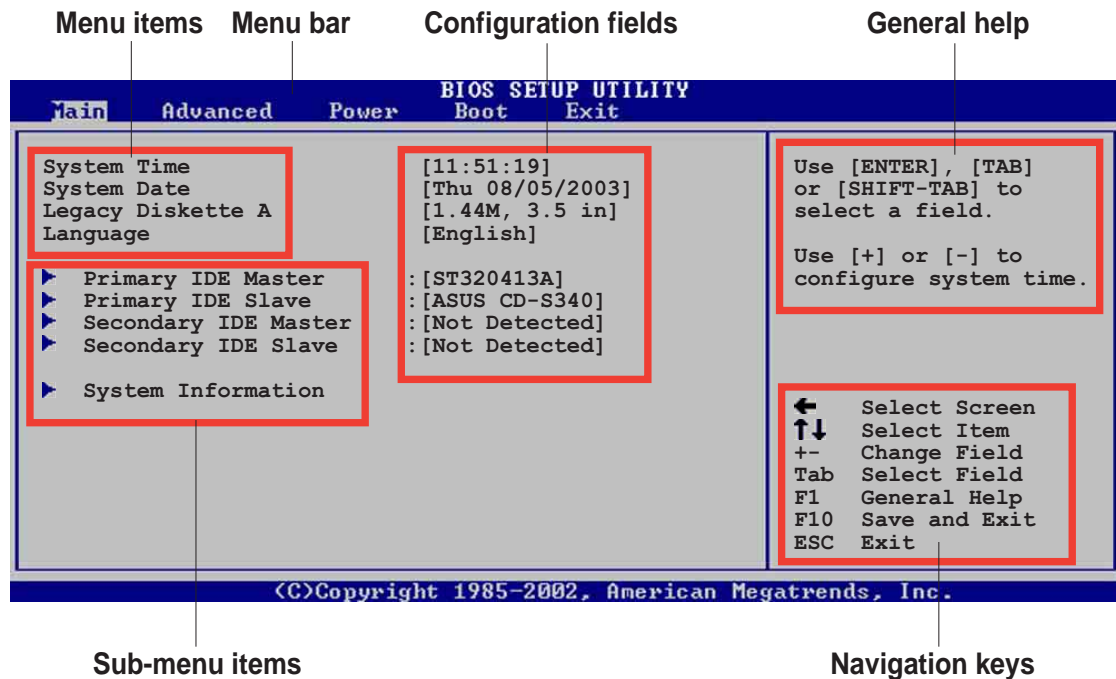

2.2.2 Menu bar

The menu bar on top of the screen has the following main items:

Main	For changing the basic system configuration
Advanced	For changing the advanced system settings
Power	For changing the advanced power management (APM) configuration
Boot	For changing the system boot configuration
Exit	For selecting the exit options and loading default settings

To select an item on the menu bar, press the right or left arrow key on the keyboard until the desired item is highlighted.

2.2.3 Navigation keys

At the **bottom right corner** of a menu screen are the navigation keys for that particular menu. Use the navigation keys to select items in the menu and change the settings.



Some of the navigation keys differ from one screen to another.

2.2.4 Menu items

The highlighted item on the menu bar displays the specific items for that menu. For example, selecting **Main** shows the Main menu items.

The other items (Advanced, Power, Boot, and Exit) on the menu bar have their respective menu items.

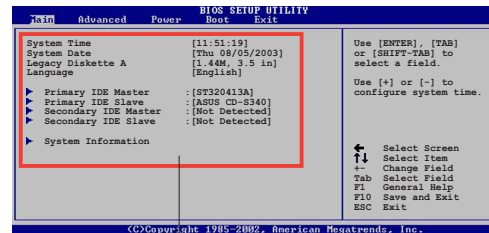

Main menu items

2.2.5 Sub-menu items

An item with a sub-menu on any menu screen is distinguished by a solid triangle before the item. To display the sub-menu, select the item and press **<Enter>**.

2.2.6 Configuration fields

These fields show the values for the menu items. If an item is user-configurable, you may change the value of the field opposite the item. You can not select an item that is not user-configurable.

A configurable field is enclosed in brackets, and is highlighted when selected. To change the value of a field, select it then press **<Enter>** to display a list of options. Refer to “2.2.7 Pop-up window.”

2.2.7 Pop-up window

Select a menu item then press Enter to display a pop-up window with the configuration options for that item.

2.2.8 Scroll bar

A scroll bar appears on the right side of a menu screen when there are items that do not fit on the screen. Press **Up/Down arrow keys** or **PageUp/PageDown keys** to display the other items on the screen.

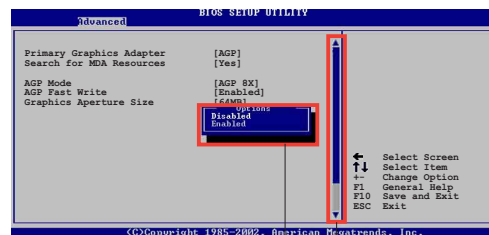

Pop-up window

Scroll bar

2.2.9 General help

At the top right corner of the menu screen is a brief description of the selected item.

2.3 Main menu

When you enter the BIOS Setup program, the Main menu screen appears giving you an overview of the basic system information.



Refer to section “2.2.1 BIOS menu screen” for information on the menu screen items and how to navigate through them.

```

BIOS SETUP UTILITY
Main  Advanced  Power  Boot  Exit

System Time           [11:51:19]
System Date           [Thu 08/05/2003]
Legacy Diskette A    [1.44M, 3.5 in]
Language              [English]

▶ Primary IDE Master   : [ST320413A]
▶ Primary IDE Slave    : [ASUS CD-S340]
▶ Secondary IDE Master : [Not Detected]
▶ Secondary IDE Slave  : [Not Detected]

▶ System Information

Use [ENTER], [TAB]
or [SHIFT-TAB] to
select a field.

Use [+] or [-] to
configure system time.

↔ Select Screen
↑↓ Select Item
+- Change Option
F1 General Help
F10 Save and Exit
ESC Exit

v00.00 (C)Copyright 1985-2002, American Megatrends, Inc.
```

2.3.1 System Time [xx:xx:xxxx]

Allows you to set the system time.

2.3.2 System Date [Day xx/xx/xxxx]

Allows you to set the system date.

2.3.3 Legacy Diskette A [1.44M, 3.5 in.]

Sets the type of floppy drive installed.

Configuration options: [Disabled] [360K, 5.25 in.] [1.2M, 5.25 in.] [720K, 3.5 in.] [1.44M, 3.5 in.] [2.88M, 3.5 in.]

2.3.4 Language [English]

Allows you to choose the BIOS language version from the available options.

Configuration options: [Français] [German] [English]

2.3.5 Primary and Secondary IDE Master/Slave

While entering Setup, BIOS auto-detects the presence of IDE devices. There is a separate sub-menu for each IDE device. Select a device item then press <Enter> to display the IDE device information.

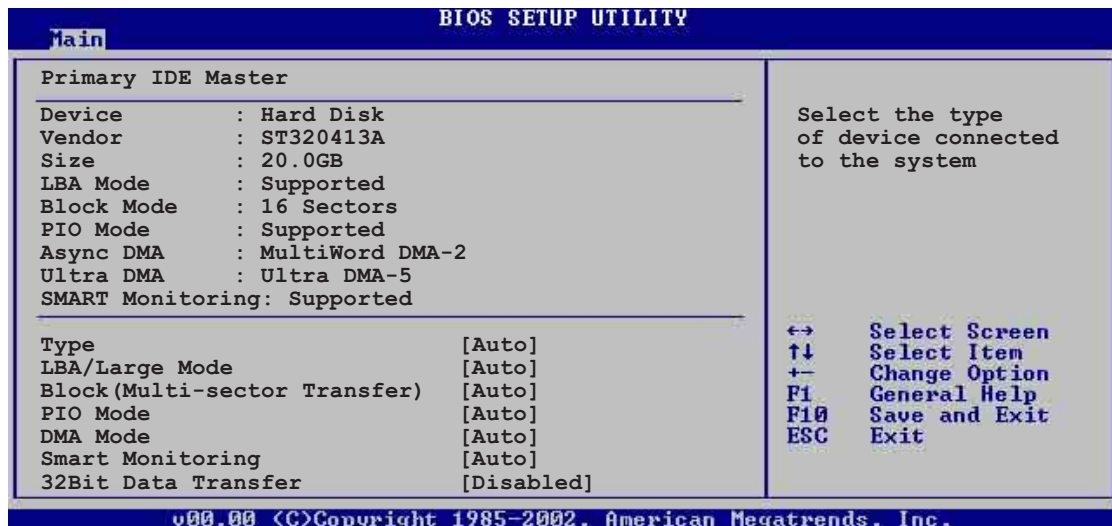

The values opposite the dimmed items (Device, Vendor, Size, LBA Mode, Block Mode, PIO Mode, Async DMA, Ultra DMA, and SMART monitoring) are auto-detected by BIOS and are not user-configurable. These items show N/A if no IDE device is installed in the system.

Type [Auto]

Selects the type of IDE drive. Setting to Auto allows automatic selection of the appropriate IDE device type. Select CDROM if you are specifically configuring a CD-ROM drive. Select ARMD (ATAPI Removable Media Device) if your device is either a ZIP, LS-120, or MO drive.

Configuration options: [Not Installed] [Auto] [CDROM] [ARMD]

LBA/Large Mode [Auto]

Enables or disables the LBA mode. Setting to Auto enables the LBA mode if the device supports this mode, and if the device was not previously formatted with LBA mode disabled. Configuration options: [Disabled] [Auto]

Block (Multi-sector Transfer) [Auto]

Enables or disables data multi-sectors transfers. When set to Auto, the data transfer from and to the device occurs multiple sectors at a time if the device supports multi-sector transfer feature. When set to Disabled, the data transfer from and to the device occurs one sector at a time.

Configuration options: [Disabled] [Auto]

PIO Mode [Auto]

Selects the PIO mode. Configuration options: [Auto] [0] [1] [2] [3] [4]

DMA Mode [Auto]

Selects the DMA mode. Configuration options: [Auto] [SWDMA0] [SWDMA1] [SWDMA2] [MWDMA0] [MWDMA1] [MWDMA2] [UDMA0] [UDMA1] [UDMA2] [UDMA3] [UDMA4] [UDMA5]

SMART Monitoring [Auto]

Sets the Smart Monitoring, Analysis, and Reporting Technology.
Configuration options: [Auto] [Disabled] [Enabled]

32Bit Data Transfer [Disabled]

Enables or disables 32-bit data transfer.
Configuration options: [Disabled] [Enabled]

2.3.6 System Information

This menu gives you an overview of the general system specifications. The items in this menu are auto-detected by BIOS.



AMI BIOS

Displays the auto-detected BIOS information.

System Memory

Displays the auto-detected system memory.

2.4 Advanced menu

The Advanced menu items allow you to change the settings for the CPU and other system devices.



Take caution when changing the settings of the Advanced menu items. Incorrect field values may cause the system to malfunction.

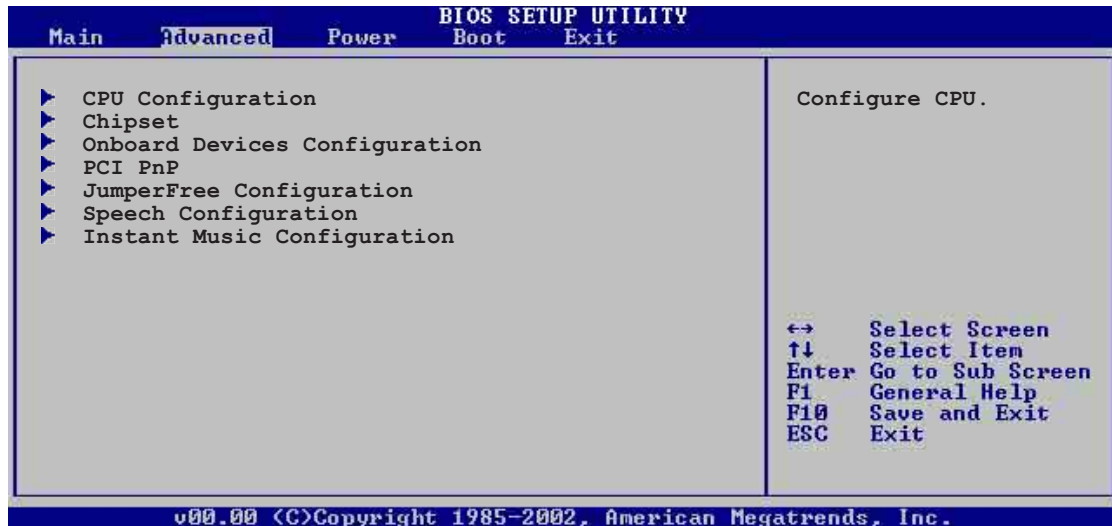

2.4.1 CPU Configuration

The items in this menu show the CPU-related information auto-detected by BIOS.

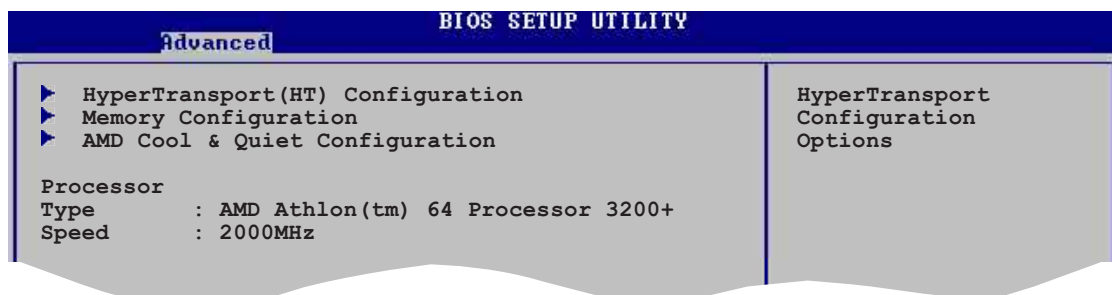

HyperTransport Configuration

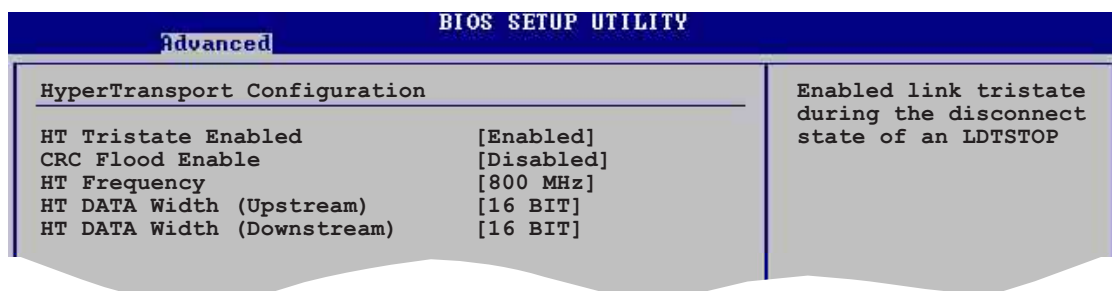

HT Tristate Enable [Enabled]

Enables or disables the HyperTransport Tristate that enables the tristate link during the disconnected state of an LDTSTOP. Configuration options: [Disabled] [Enabled]

CRC Flood Enable [Disabled]

Enables or disables the CRC Flood that enable the generation of synchronized packets on CRC Error. Configuration options: [Disabled] [Enabled]

HT Frequency [800 MHz]

Allows frequency selection of HyperTransport transfer from K8 CPU to AGP. Configuration options: [200 MHz] [400 Mhz] [600 Mhz] [800 Mhz]

HT DATA Width (Upstream) [16 BIT]

Allows selection of HyperTransport upstream data width. Configuration options: [16 BIT] [8 BIT]

HT DATA Width (Downstream) [16 BIT]

Allows selection of HyperTransport downstream data width. Configuration options: [16 BIT] [8 BIT]

Memory Configuration

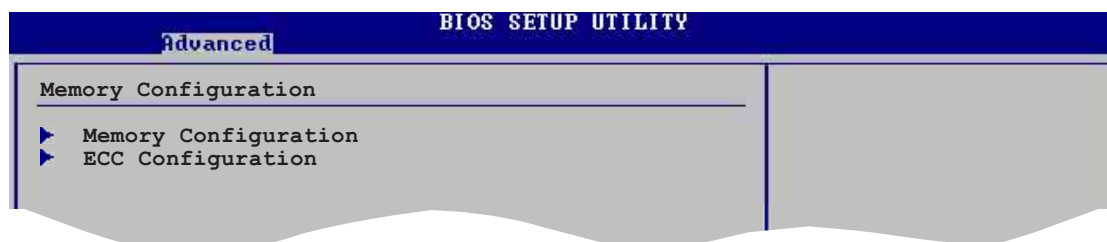

Memory Configuration

The Memory configuration menu item allows you to change the memory settings. Select an item then press <Enter> to display the sub-menu.

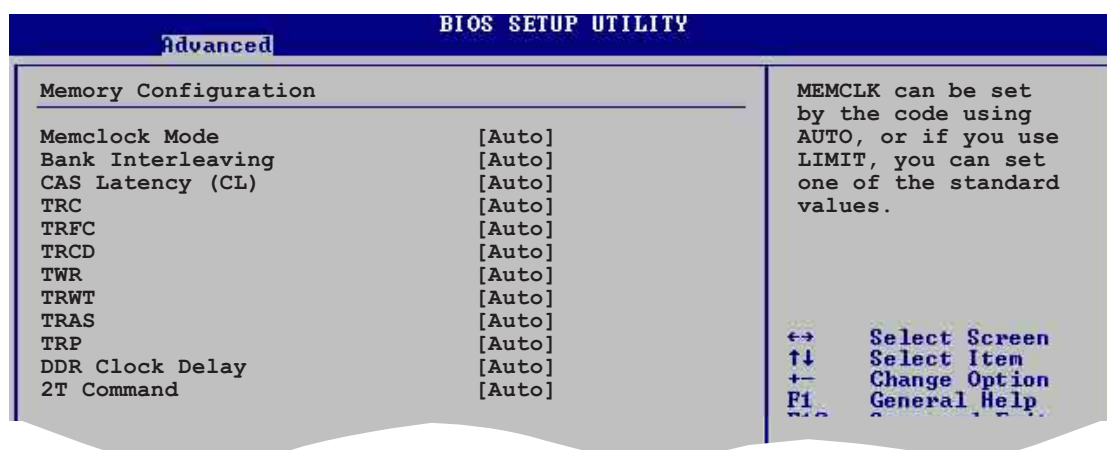

Memclock Mode [Auto]

Allows you to set the memory clock mode. Set by the code using [Auto] or select [Manual] to set using one of the standard values. Configuration options: [Auto] [Limit]

Memclock to CPU Ratio [1:1 (DDR 200)]

Sets the memory clock to CPU ratio.

Configuration options: [1:1 (DDR 200)] [4:3 (DDR 266)] [3:2] [5:3 (DDR 333)] [2:1 (DDR 400)]

Bank Interleaving [Auto]

Sets whether to allow memory accesses to be spread out over BANKS on the same node or across nodes, decreasing access contention.

Configuration options: [Auto] [Disabled]

CAS Latency (CL) [Auto]

Sets the CAS Latency. Configuration options: [Auto] [2.0] [3.0] [2.5]

TRC [Auto]

Sets the TRC.

Configuration options: [Auto] [7 CLK] [8 CLK] [9 CLK] [10 CLK] [11 CLK] [12 CLK] [13 CLK]

TRFC [Auto]

Sets the TRFC.

Configuration options: [Auto] [9 CLK] [10 CLK] [11 CLK] [12 CLK] [13 CLK] [14 CLK] [15 CLK]

TRCD [Auto]

Sets the TRCD.

Configuration options: [Auto] [2 CLK] [3 CLK] [4 CLK] [5 CLK] [6 CLK]

TWR [Auto]

Sets the TWR. Configuration options: [Auto] [2 CLK] [3 CLK]

TRWT [Auto]

This item sets the TRWT.

Configuration options: [Auto] [1 CLK] [2 CLK] [3 CLK] [4 CLK] [5 CLK] [6 CLK]

TRAS [Auto]

This item sets the TRAS.

Configuration options: [Auto] [5 CLK] [6 CLK] [7 CLK] [8 CLK] [9 CLK] [10 CLK] [11 CLK] [12 CLK] [13 CLK] [14 CLK] [15 CLK]

TRP [Auto]

Sets the TRP.

Configuration options: [Auto] [2 CLK] [3 CLK] [4 CLK] [5 CLK] [6 CLK]

DDR Clock Delay [Auto]

Sets the DDR clock delay.

Configuration options: [Auto] [1 CLK] [2 CLK] [3 CLK] [4 CLK] [5 CLK] [6 CLK]

2T Command [Auto]

Sets the 2T command clock.

Configuration options: [Auto] [1 CLK] [2 CLK] [3 CLK] [4 CLK] [5 CLK] [6 CLK]

ECC Configuration

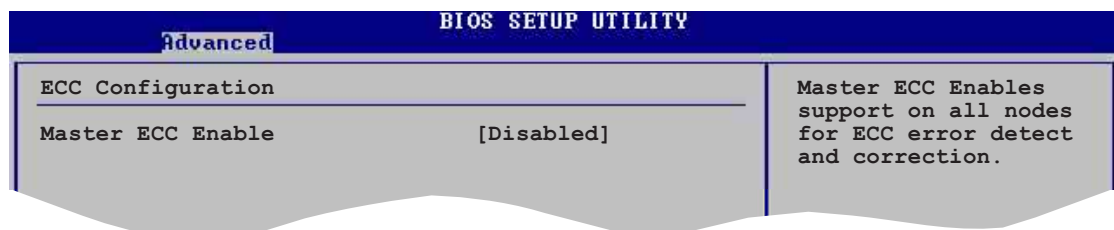

Master ECC Enable [Disabled]

Enables or disables support on all nodes for ECC error detect and correction.

Configuration options: [Disabled] [Enabled]



The following items appear only when the **Master ECC Enable** item is set to [Enabled].

DRAM ECC Enable [Disabled]

Enables or disables the DRAM ECC that allows hardware to report and correct memory errors automatically to maintain system integrity.

Configuration options: [Disabled] [Enabled]

L2 Cache BG Scrub [Disabled]

Disables or sets the L2 data cache RAM to be corrected when idle.

Configuration options: [Disabled] [40ns] [80ns] [160ns] [320ns] [640ns] [1.28us] [2.56us] [5.12us] [10.2us] [20.5us] [41.0us] [81.9us] [163.8us] [327.7us] [655.4us] [1.31ms] [2.62ms] [5.24ms] [10.49ms] [20.97ms] [42.00ms] [84.00ms]

Data Cache BG Scrub [Disabled]

Disables or sets the L1 data cache RAM to be corrected when idle.

Configuration options: [Disabled] [40ns] [80ns] [160ns] [320ns] [640ns] [1.28us] [2.56us] [5.12us] [10.2us] [20.5us] [41.0us] [81.9us] [163.8us] [327.7us] [655.4us] [1.31ms] [2.62ms] [5.24ms] [10.49ms] [20.97ms] [42.00ms] [84.00ms]



The following items appear only when the **DRAM ECC Enable** item is set to [Enabled].

DRAM BG Scrub [60ns]

Disables or sets the DRAM scrubbing functionality that corrects and rewrites memory errors so later reads are correct. Doing this while the memory is not being used improves performance. Configuration options: [Disabled] [40ns] [80ns] [160ns] [320ns] [640ns] [1.28us] [2.56us] [5.12us] [10.2us] [20.5us] [41.0us] [81.9us] [163.8us] [327.7us] [655.4us] [1.31ms] [2.62ms] [5.24ms] [10.49ms] [20.97ms] [42.00ms] [84.00ms]

DRAM SCRUB REDIRECT [Disabled]

Sets the system to correct DRAM ECC errors immediately when they occur, even if background scrubbing is on. Configuration options: [Disabled] [Enabled]

ECC Chip Kill [Disabled]

Enables or disables the ECC chip kill feature.
Configuration options: [Disabled] [Enabled]

AMD Cool & Quiet Configuration

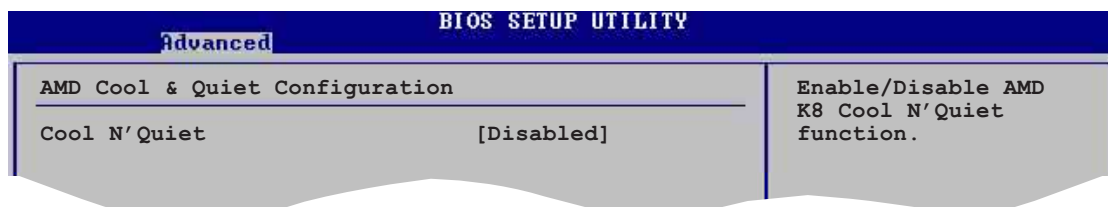

Cool N' Quiet [Disabled]

Allows you to enable or disable the AMD Cool 'n' Quiet!™ Technology feature.
Configuration options: [Enabled] [Disabled]



- Make sure that the above item is set to **Enabled** if you want to use the AMD CPU Cool 'n' Quiet!™ Technology feature.
- This feature requires the AMD CPU heatsink and fan package with monitor chip. If you purchased a separate heatsink and fan package, use the ASUS Q-Fan Technology feature to automatically adjust your CPU fan speed according to your system loading.

Processor

Displays the processor type and speed.

2.4.2 Chipset

The Chipset menu items allow you to change the advanced chipset settings. Select an item then press **<Enter>** to display the sub-menu.

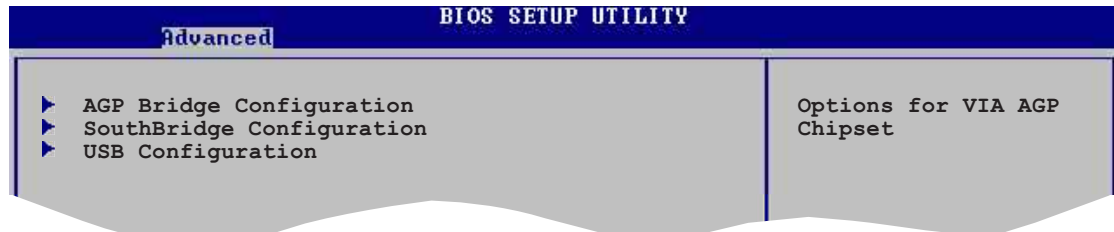

AGP Bridge Configuration

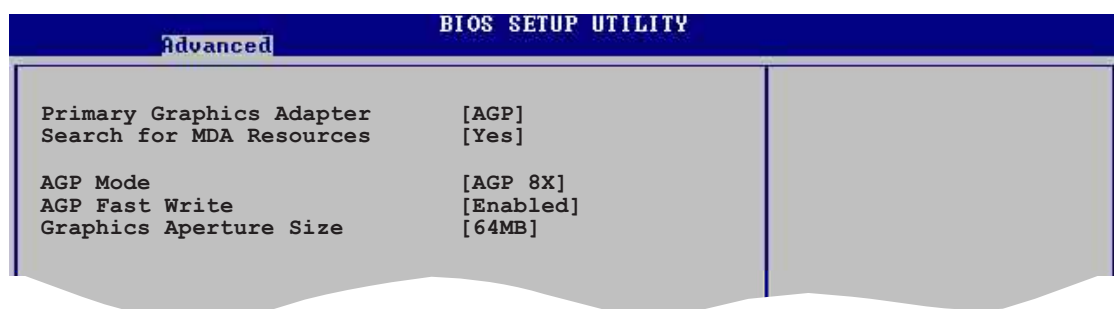

Primary Graphics Adapter [AGP]

Switches the PCI Bus scanning order while searching for a video card. This allows you to select the type of Primary VGA in case of multiple video controllers.

Configuration options: [PCI] [AGP]

Search for MDA Resources [Yes]

Sets whether to allow search for MDA resources.

Configuration options: [Yes] [No]

AGP Mode [AGP 8X]

Allows you to set the data throughput of your AGP graphics card. This motherboard supports the AGP 8X interface that transfers video data at 2.12GB/s. The default and configuration options vary depending on the speed of AGP card you installed. If you installed an AGP 8X graphics card, the configuration options are as follows: [8X] [4X] or if you installed an AGP 4X graphics card, the configuration options are as follows: [4X] [2X].

AGP Fast Write [Enabled]

Enables or disables the AGP Fast Write feature.

Configuration options: [Disabled] [Enabled]

Graphics Aperture Size [64MB]

Allows you to select the size of mapped memory for AGP graphic data.

Configuration options: [32MB] [64MB] [128MB] [256MB]

SouthBridge Configuration

Advanced		BIOS SETUP UTILITY	
MPS Revision	[1.4]		
PCI Delay Transaction	[Disabled]		

MPS Revision [1.4]

Sets the MPS revision value. Configuration options: [1.1] [1.4]

PCI Delay Transaction [Disabled]

Enables or disables the PCI Delay transaction feature.

Configuration options: [Disabled] [Enabled]

USB Configuration

The items in this menu allows you to change the USB-related features. Select an item then press <Enter> to display the configuration options.

Advanced		BIOS SETUP UTILITY	
USB Configuration		Enables USB host controllers.	
Module Version - 2.23.2-7.4			
USB Devices Enabled: None			
USB 1.1 Ports Configuration	[USB 8 Ports]		
USB 2.0 Controller	[Enabled]		
Legacy USB Support	[Auto]		
USB 2.0 Controller Mode	[FullSpeed]		



The Module Version and USB Devices Enabled items show the auto-detected values. If no USB device is detected, the item shows None.

USB 1.1 Ports Configuration [USB 8 Ports]

Allows you to set the number of USB ports to activate.

Configuration options: [Disabled] [USB 2 Ports] [USB 4 Ports] [USB 6 Ports] [USB 8 Ports]

USB 2.0 Controller [Enabled]

Allows you to enable or disable the USB 2.0 ports controller.

Configuration options: [Disabled] [Enabled]

Legacy USB Support [Auto]

Allows you to enable or disable support for legacy USB devices. Setting to Auto allows the system to detect the presence of USB devices at startup. If detected, the USB controller legacy mode is enabled. If no USB device is detected, the legacy USB support is disabled. Configuration options: [Disabled] [Enabled] [Auto]

USB 2.0 Controller Mode [FullSpeed]

Allows you to configure the USB 2.0 controller in HiSpeed (480 Mbps) or Full Speed (12 Mbps). Configuration options: [HiSpeed] [Full Speed]

2.4.3 Onboard Devices Configuration

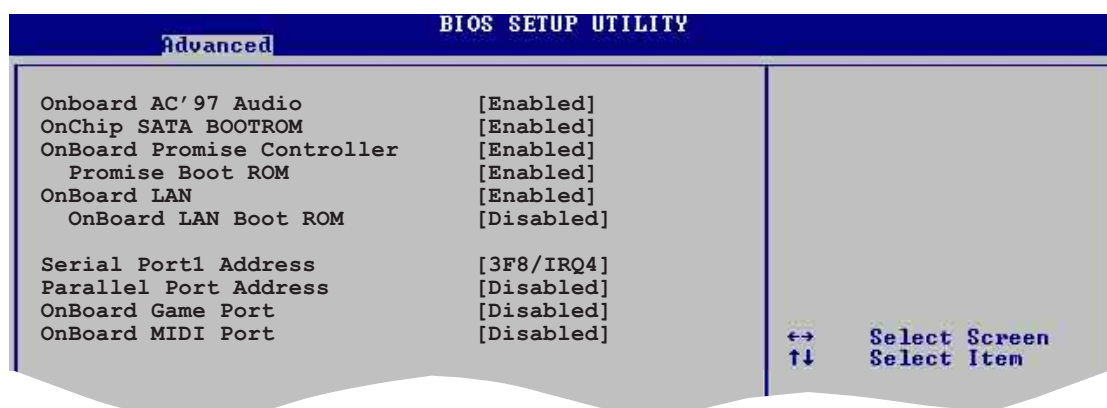

OnBoard AC'97 Audio [Enabled]

[Auto] allows the BIOS to detect whether you are using any audio device. If an audio device is detected, the onboard audio controller is enabled; if no audio device is detected, the controller is disabled.

Configuration options: [Disabled] [Enabled]

OnChip SATA Boot ROM [Enabled]

Allows you to enable or disable the onchip Serial ATA boot ROM.

Configuration options: [Disabled] [Enabled]

OnBoard Promise Controller [Enabled]

Allows you to enable or disable the onboard Promise RAID controller.

Configuration options: [Disabled] [Enabled]

Promise Boot ROM [Enabled]

Enables or disables the Promise Boot ROM.

Configuration options: [Disabled] [Enabled]

OnBoard LAN [Enabled]

Allows you to enable or disable the onboard LAN controller.
Configuration options: [Disabled] [Enabled]

OnBoard LAN Boot ROM [Disabled]

Allows you to enable or disable the onboard LAN boot ROM.
Configuration options: [Disabled] [Enabled]

Serial Port1 Address [3F8/IRQ4]

Allows you to select the Serial Port1 base address.
Configuration options: [Disabled] [3F8/IRQ4] [3E8/IRQ4] [2E8/IRQ3]

Parallel Port Address [378]

Allows you to select the Parallel Port base addresses.
Configuration options: [Disabled] [378] [278] [3BC]

Parallel Port Mode [Normal]

Allows you to select the Parallel Port mode.
Configuration options: [Normal] [Bi-Directional] [EPP] [ECP]

EPP Version [1.9]

Appears only when the Parallel Port Mode is set to [EPP]. This item allows you to select the Parallel Port EPP version. Configuration options: [1.9] [1.7]

ECP Mode DMA Channel [DMA3]

Appears only when the Parallel Port Mode is set to [ECP]. This item allows you to set the Parallel Port ECP DMA.
Configuration options: [DMA0] [DMA1] [DMA3]

Parallel Port IRQ [IRQ7]

Sets the Parallel Port IRQ. Configuration options: [IRQ5] [IRQ7]

Onboard Game Port [Disabled]

Enables or disables the onboard GAME port.
Configuration options: [Disabled] [Enabled]

Onboard MIDI Port [Disabled]

Enables or disables the onboard MIDI port.
Configuration options: [Disabled] [Enabled]

2.4.4 PCI PnP

The PCI PnP menu items allow you to change the advanced settings for PCI/PnP devices. The menu includes setting IRQ and DMA channel resources for either PCI/PnP or legacy ISA devices, and setting the memory size block for legacy ISA devices.



Take caution when changing the settings of the PCI PnP menu items. Incorrect field values may cause the system to malfunction.

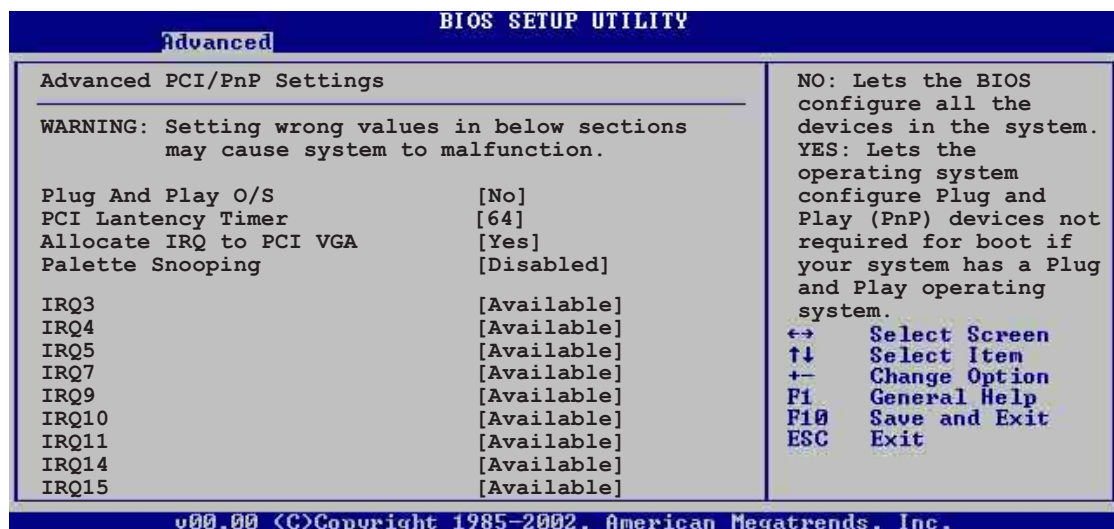

Palette Snooping [Disabled]

When set to [Enabled], the palette snooping feature informs the PCI devices that an ISA graphics device is installed in the system so that the latter can function correctly. Setting to [Disabled] deactivates this feature.

Configuration options: [Disabled] [Enabled]

IRQ xx [Available]

When set to [Available], the specific IRQ is free for use of PCI/PnP devices. When set to [Reserved], the IRQ is reserved for legacy ISA devices.

Configuration options: [Available] [Reserved]

2.4.5 JumperFree Configuration

Advanced		BIOS SETUP UTILITY	
Configure System Frequency/Voltage			
CPU FSB Frequency		[200 MHz]	
CPU Speed/Voltage Setting		[Auto]	
DDR Voltage		[Auto]	
AGP Voltage		[1.5V]	
V-Link Voltage		[2.5V]	
Performance Mode		[Auto]	

CPU FSB Frequency [200MHz]

Allows you to adjust the CPU FSB operating frequency.

Configuration options: [200MHz] [201 MHz] ~ [300MHz]

CPU Speed/Voltage Setting [Auto]

Allows you to set the CPU speed and voltage.

Configuration options: [Auto] [Manual]

CPU Speed [800 MHz]

Allows you to manually set the CPU speed. This item appears only when the **CPU Speed/Voltage Setting** item is set to Manual.

Configuration options: [800 MHz] [900 MHz] [1000 MHz] [1100 MHz] [1200 MHz] [1300 MHz] [1400 MHz] [1500 MHz] [1600 MHz] [1700 MHz] [1800 MHz] [1900 MHz] [2000 MHz]

CPU Voltage [1.400 V]

Allows you to manually set the CPU voltage. This item appears only when the **CPU Speed/Voltage Setting** item is set to Manual.

Configuration options: [1.750 V] [1.725 V] [1.700 V] [1.675 V] [1.650 V] [1.625 V] [1.600 V] [1.575 V] [1.550 V] [1.525 V] [1.500 V] [1.475 V] [1.450 V] [1.425 V] [1.400 V] [1.375 V] [1.350 V] [1.325 V] [1.300 V] [1.275 V] [1.250 V] [1.225 V] [1.200 V] [1.175 V] [1.150 V] [1.125 V] [1.100 V] [1.075 V] [1.050 V] [1.025 V] [1.000 V] [0.975 V] [0.950 V] [0.925 V] [0.900 V] [0.875 V] [0.850 V] [0.825 V] [0.800 V] [Shutdown]

DDR Voltage [Auto]

Allows you to automatically detect or select from a list the DDR operating voltage.

Configuration options: [Auto] [2.6V] [2.7V] [2.8V]

AGP Voltage [1.5V]

Adjusts the AGP voltage setting.

Configuration options: [1.5V] [1.7V]

V-Link Voltage [2.5V]

Adjusts the V-Link voltage setting. Configuration options: [2.5V] [2.6V]

Performance Mode [Auto]

Allows enhanced system performance. Setting to [TurboX] may cause the system to become unstable. If this happens, revert to the default setting [Standard].

Configuration options: [Auto] [Standard] [Turbo]

2.4.6 Instant Music Configuration

BIOS SETUP UTILITY	
Advanced	
Instant Music Option	
Instant Music	[Disabled]
If enabled, power up by PS/2 keyboard function will be disabled.	

Instant Music [Disabled]

Allows you to enable or disable the Instant Music feature in BIOS.

Configuration options: [Disabled] [Enabled]



When Instant Music is enabled, the PS/2 keyboard power up feature is automatically disabled. See page 3-5 for details.

Instant Music CD-ROM Drive [IDE Secondary Master]

Allows you to select the CD-ROM drive that you wish to use for the Instant Music CD playback. Configuration options: [IDE Primary Master] [IDE Primary Slave]

[IDE Secondary Master] [IDE Secondary Slave]



The above item appears only if you enabled the Instant Music item.

2.5 Power menu

The Power menu items allow you to change the settings for the Advanced Power Management (APM) feature. Select an item then press <Enter> to display the configuration options.

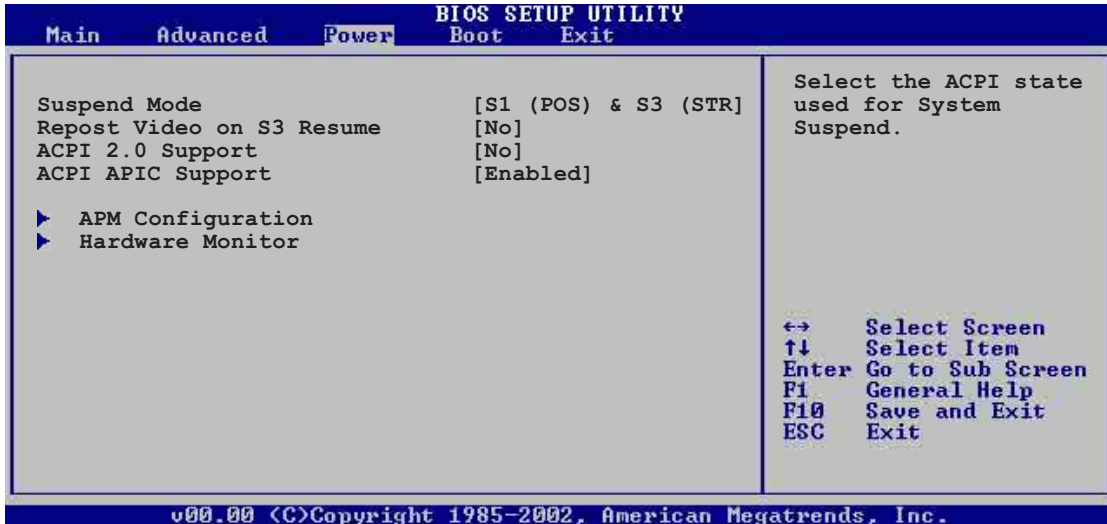

2.5.1 Suspend Mode [S1 (POS) & S3 (STR)]

Allows you to select the ACPI state to be used for system suspend.

Configuration options: [S1 (POS) Only] [S3 Only] [S1 (POS) & S3 (STR) Auto]

2.5.2 Repost Video on S3 Resume [No]

Determines whether to invoke VGA BIOS POST on S3/STR resume.

Configuration options: [No] [Yes]

2.5.3 ACPI 2.0 Support [No]

Allows you to add more tables for ACPI 2.0 specifications.

Configuration options: [No] [Yes]

2.5.4 ACPI APIC Support [Enabled]

Enables or disables the ACPI support in the ASIC. When set to Enabled, the ACPI APIC table pointer is included in the RSDT pointer list.

Configuration options: [Disabled] [Enabled]

2.5.5 APM Configuration

BIOS SETUP UTILITY	
Power	
Power Management/APM	[Enabled]
Power Button Mode	[On/Off]
Suspend Power Saving Type	[C3]
Restore on AC Power Loss	[Last State]
Suspend Time Out	[Disabled]
Hard Disk Time Out (Minute)	[Disabled]
Video Power Down Mode	[Suspend]
Hard Disk Power Down Mode	[Enabled]
Power On By RTC Alarm	[Disabled]
Power On External Modems	[Disabled]
Power On PCI Device	[Disabled]
Power On PS/2 Keyboard	[Disabled]
Power On PS/2 Mouse	[Disabled]

←→ Select Screen
↑↓ Select Item
+- Change Option
F1 General Help
F10 Save and Exit
ESC Exit

v00.00 (C)Copyright 1985-2002, American Megatrends, Inc.

Power Management/APM [Enabled]

Allows you to enable or disable the Advanced Power Management (APM) feature.
Configuration options: [Disabled] [Enabled]



The following items appear only when the Power Management/APM item is set to [Enabled].

Power Button Mode [On/Off]

Allows the system to go into On/Off mode or suspend mode when the power button is pressed. Configuration options: [On/Off] [Standby] [Suspend]

Suspend Power Saving Type [C3]

Allows you to set the suspend power saving type.
Configuration options: [C3] [S1]

Restore on AC Power Loss [Last State]

When set to Power Off, the system goes into off state after an AC power loss. When set to Power On, the system goes on after an AC power loss. When set to Last State, the system goes into either off or on state whatever the system state before the AC power loss.

Configuration options: [Power Off] [Power On] [Last State]

Suspend Time Out [Disabled]

Allows you to select the specified time at which the system goes on suspend mode. Configuration options: [Disabled] [1 Min] [2 Min] [4 Min] [8 Min] [10 Min] [20 Min] [30 Min] [40 Min] [50 Min] [60 Min]

Hard Disk Time Out (Minute) [Disabled]

Allows you to select the specified time in minute at which the hard disk goes on standby mode. Configuration options: [Disabled] [1] [2] ~ [15]

Video Power Down Mode [Suspend]

Allows you to select the video power down mode.
Configuration options: [Disabled] [Standby] [Suspend]

Hard Disk Power Down Mode [Enabled]

Allows you to enable or disable the hard disk power down mode.
Configuration options: [Disabled] [Enabled]

Power On By RTC Alarm [Disabled]

Allows you to enable or disable RTC to generate a wake event. When this item is set to Enabled, the items RTC Alarm Date, RTC Alarm Hour, RTC Alarm Minute, and RTC Alarm Second appear with set values.
Configuration options: [Disabled] [Enabled]

Power On External Modems [Disabled]

Allows either settings of [Enabled] or [Disabled] for powering up the computer when the external modem receives a call while the computer is in Soft-off mode.
Configuration options: [Disabled] [Enabled]



The computer cannot receive or transmit data until the computer and applications are fully running. Thus, connection cannot be made on the first try. Turning an external modem off and then back on while the computer is off causes an initialization string that turns the system power on.

Power On PCI Device [Disabled]

Allows you to enable or disable power on PCI device feature. This feature requires an ATX power supply that provides at least 1A on the +5VSB lead.
Configuration options: [Disabled] [Enabled]

Power On PS/2 Keyboard [Disabled]

Allows you to enable or disable the keyboard wake-up feature. This feature requires an ATX power supply that provides at least 1A on the +5VSB lead.
Configuration options: [Disabled] [Enabled]

Power On PS/2 Mouse [Disabled]

When set to [Enabled], this parameter allows you to use the PS/2 mouse to resume the system. This feature requires an ATX power supply that provides at least 1A on the +5VSB lead. Configuration options: [Disabled] [Enabled]

2.5.6 Hardware Monitor

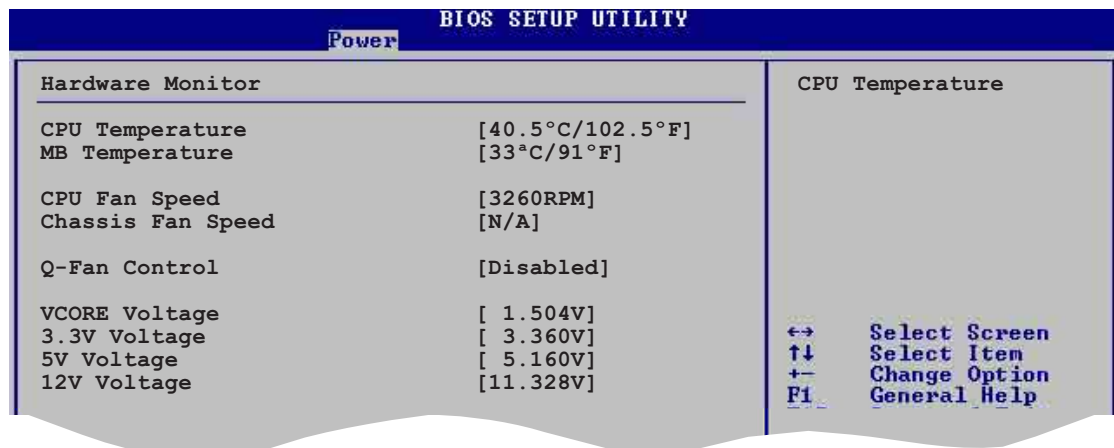

CPU Temperature [xxx °C/xxx °F]

MB Temperature [xxx °C/xxx °F]

The onboard hardware monitor automatically detects and displays the motherboard and CPU temperatures. Select Disabled if you do not wish to display the detected temperatures.

CPU Fan Speed [xxxxRPM] or [N/A]

Chassis Fan Speed [xxxxRPM] or [N/A]

The onboard hardware monitor automatically detects and displays the CPU and chassis fan speeds in rotations per minute (RPM). If any of the fans is not connected to the motherboard, the specific field shows N/A.

Q-Fan Control [Disabled]

Allows you to enable or disable the ASUS Q-Fan feature that smartly adjusts the fan speeds for more efficient system operation. When this field is set to [Enabled]. Configuration options: [Disabled] [Enabled]

VCORE Voltage, +3.3V Voltage, +5V Voltage, +12V Voltage

The onboard hardware monitor automatically detects the voltage output through the onboard voltage regulators.



If any of the monitored items is out of range, the following error message appears: "Hardware Monitor found an error. Enter Power setup menu for details". You will then be prompted to "Press F1 to continue or DEL to enter SETUP".

2.6 Boot menu

The Boot menu items allow you to change the system boot options. Select an item then press <Enter> to display the sub-menu.

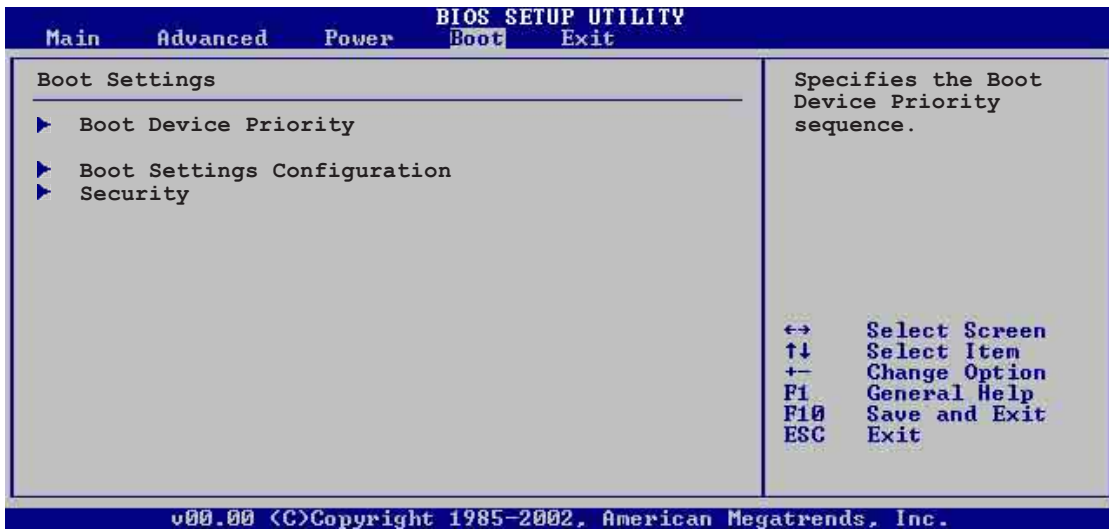

2.6.1 Boot Device Priority

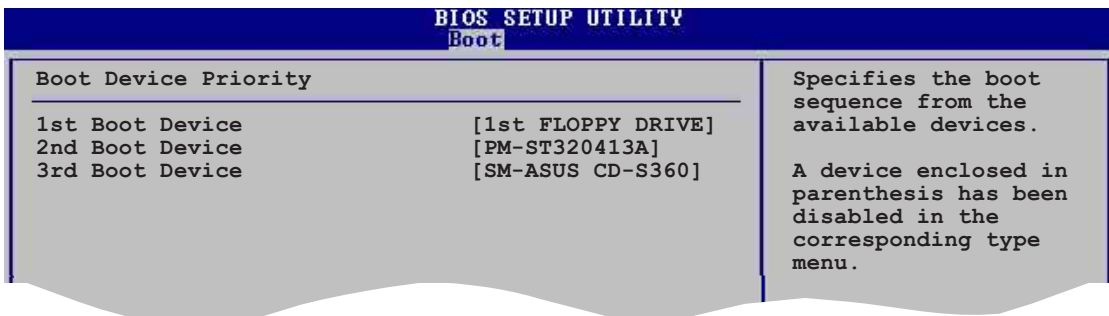

1st ~ xxth Boot Device [1st Floppy Drive]

These items specify the boot device priority sequence from the available devices. The number of device items that appear on the screen depends on the the number of devices installed in the system. Configuration options: [xxxxx Drive] [Disabled]

2.6.2 Boot Settings Configuration

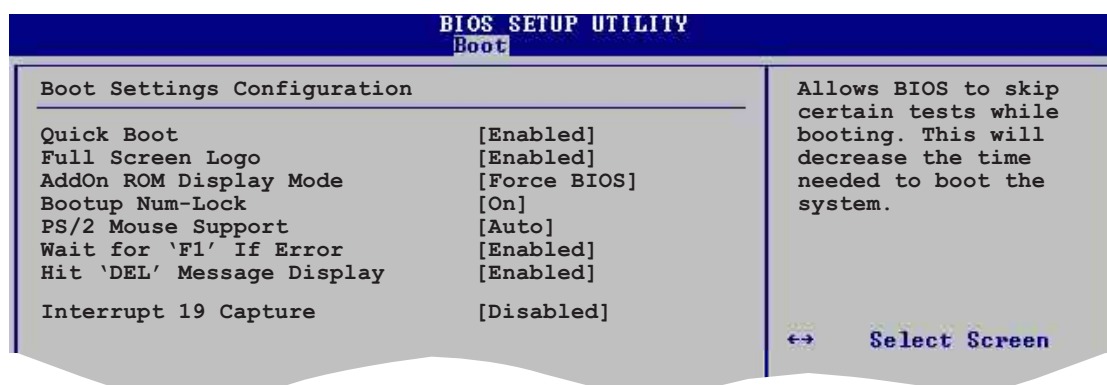

Quick Boot [Enabled]

Enabling this item allows the BIOS to skip some Power On Self Tests (POST) while booting to decrease the time needed to boot the system. When set to [Disabled], BIOS performs all the POST items. Configuration options: [Disabled] [Enabled]

Full Screen Logo [Enabled]

Allows you to enable or disable the full screen logo display feature. Configuration options: [Disabled] [Enabled]



Make sure that the above item is set to [Enabled] if you wish to use the ASUS MyLogo2™ feature.

Add On ROM Display Mode [Force BIOS]

Sets the display mode for option ROM. Configuration options: [Force BIOS] [Keep Current]

Bootup Num-Lock [On]

Allows you to select the power-on state for the NumLock. Configuration options: [Off] [On]

PS/2 Mouse Support [Auto]

Allows you to enable or disable support for PS/2 mouse. Configuration options: [Disabled] [Enabled] [Auto]

Wait for 'F1' If Error [Enabled]

When set to Enabled, the system waits for F1 key to be pressed when error occurs. Configuration options: [Disabled] [Enabled]

Hit 'DEL' Message Display [Enabled]

When set to Enabled, the system displays the message "Press DEL to run Setup" during POST. Configuration options: [Disabled] [Enabled]

Interrupt 19 Capture [Disabled]

When set to [Enabled], this function allows the option ROMs to trap Interrupt 19.
Configuration options: [Disabled] [Enabled]

2.6.3 Security

The Security menu items allow you to change the system security settings. Select an item then press **<Enter>** to display the configuration options.

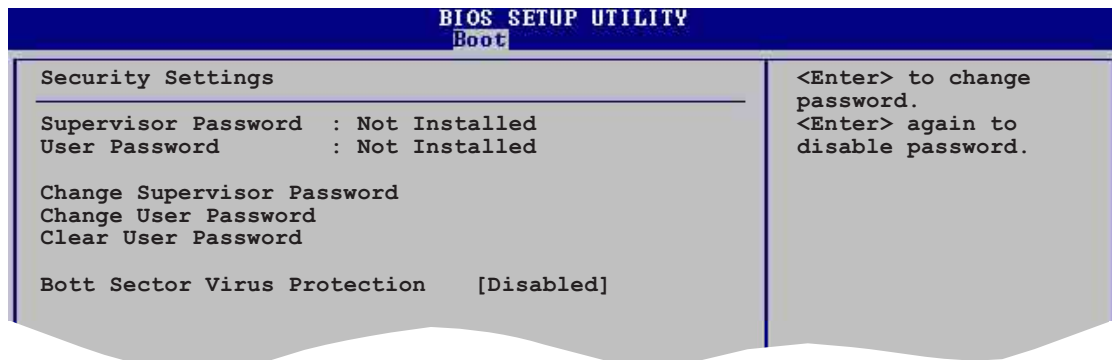

Change Supervisor Password

Select this item to set or change the supervisor password. The Supervisor Password item on top of the screen shows the default **Not Installed**. After you have set a password, this item shows **Installed**.

To set a Supervisor Password:

1. Select the Change Supervisor Password item and press **<Enter>**.
2. From the password box, type a password combination of at least six (6) letters and/or numbers, then press **<Enter>**.
3. Confirm the password when prompted. The message "Password Installed" appears after you have successfully set your password.
The Supervisor Password item now shows **Installed**.

To change the supervisor password, follow the same steps as in setting a user password.

To clear the supervisor password, select the Change Supervisor Password then press **<Enter>**. The message "Password Uninstalled" appears.



If you forget your BIOS password, you can clear it by erasing the CMOS Real Time Clock (RTC) RAM. See section "1.9 Jumpers" for information on how to erase the RTC RAM.

After you have set a supervisor password, the other items appear to allow you to change other security settings.

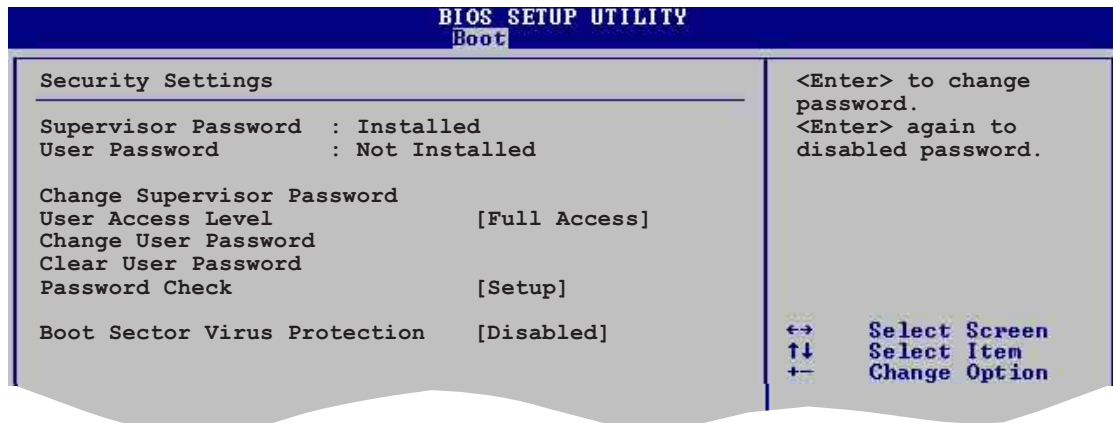

User Access Level (Full Access)

Allows you to select the access restriction to the Setup items.

Configuration options: [No Access] [View Only] [Limited] [Full Access]

No Access prevents user access to the Setup utility.

View Only allows access but does not allow change to any field.

Limited allows change only to selected fields, such as Date and Time.

Full Access allows viewing and changing all the fields in the Setup utility.

Change User Password

Select this item to set or change the user password. The User Password item on top of the screen shows the default **Not Installed**. After you have set a password, this item shows **Installed**.

To set a User Password:

1. Select the Change User Password item and press **<Enter>**.
2. On the password box that appears, type a password combination of at least six (6) letters and/or numbers, then press **<Enter>**.
3. Confirm the password when prompted. The message "Password Installed" appears after you have successfully set your password.
The User Password item now shows **Installed**.

To change the user password, follow the same steps as in setting a user password.

Clear User Password

Select this item if you wish to clear the user password.

Password Check [Setup]

When set to [Setup], BIOS checks for user password when accessing the Setup utility. When set to [Always], BIOS checks for user password both when accessing Setup and booting the system. Configuration options: [Setup] [Always]

Boot Sector Virus Protection [Disabled]

Allows you to enable or disable the boot sector virus protection.

Configuration options: [Disabled] [Enabled]

2.7 Exit menu

The Exit menu items allow you to load the optimal or failsafe default values for the BIOS items, and save or discard your changes to the BIOS items.

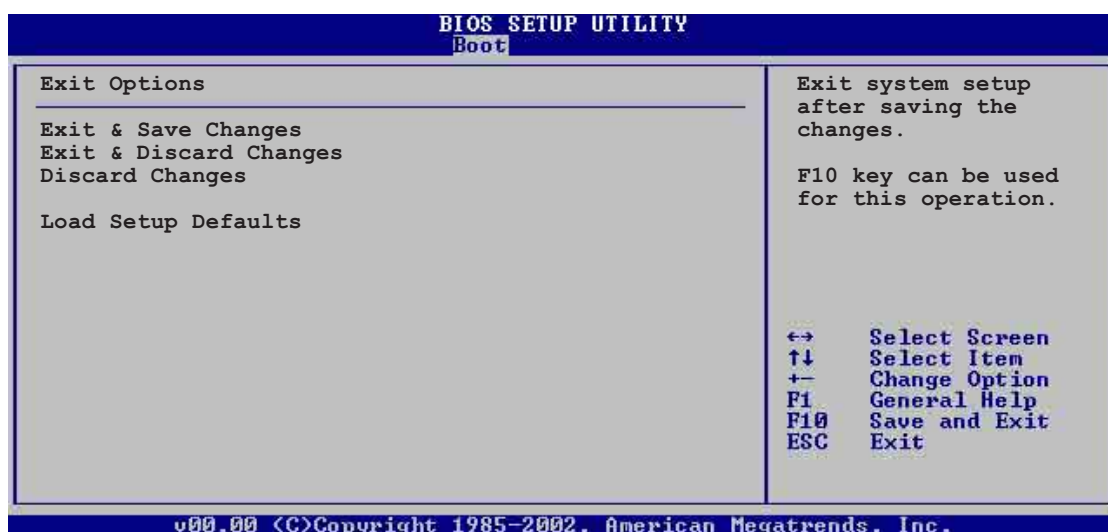

Pressing <Esc> does not immediately exit this menu. Select one of the options from this menu or <F10> from the legend bar to exit.

Exit & Save Changes

Once you are finished making your selections, choose this option from the Exit menu to ensure that the values you selected are saved to the CMOS RAM. An onboard backup battery sustains the CMOS RAM and stays on even when the PC is turned off. When you select this option, a confirmation window appears. Select **Yes** to save changes and exit.



If you attempt to exit the Setup program without saving your changes, the program prompts you with a message asking if you want to save your changes before exiting. Press <Enter> to save the changes while exiting.

Exit & Discard Changes

Select this option only if you do not want to save the changes that you made to the Setup program. If you made changes to fields other than System Date, System Time, and Password, the BIOS asks for a confirmation before exiting.

Discard Changes

Allows you to discard the selections you made and restore the previously saved values. After selecting this option, a confirmation appears. Select **Yes** to discard any changes and load the previously saved values.

Load Setup Defaults

This option allows you to load the default values for each of the parameters on the Setup menus. When you select this option or if you press <F5>, a confirmation window appears. Select **Yes** to load default values. Select **Exit Saving Changes** or make other changes before saving the values to the non-volatile RAM.

Chapter 3

This chapter describes the contents of the support CD that comes with the motherboard package.

Software support

3.1 Install an operating system®

This motherboard supports Windows® 98SE/ME/2000/2003 Server/XP operating system (OS). Always install the latest OS version and corresponding updates to maximize the features of your hardware.



Motherboard settings and hardware options vary, so use the setup procedures presented in this chapter for general reference only. Refer to your OS documentation for more information.

3.2 Support CD information

The support CD that came with the motherboard contains useful software and several utility drivers that enhance the motherboard features.



The contents of the support CD are subject to change at any time without notice. Visit the ASUS website for updates.

3.2.1 Running the support CD

To begin using the support CD, simply insert the CD into your CD-ROM drive. The CD automatically displays the **Drivers** menu if Autorun is enabled in your computer. Click on an item to install.

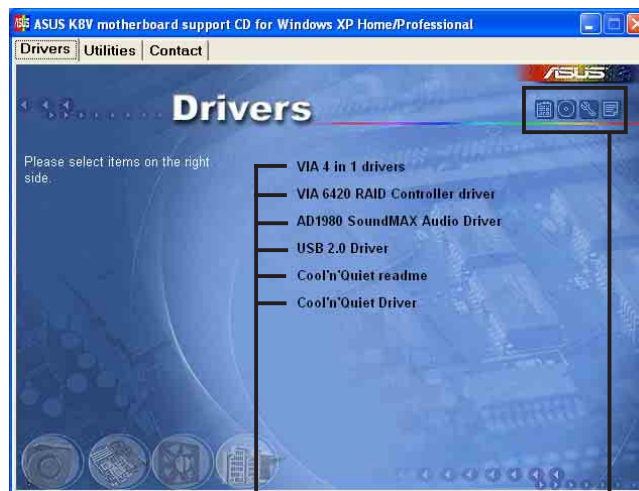

Click an item to install

Click an icon to display more information



If **Autorun** is NOT enabled in your computer, browse the contents of the support CD to locate the file **ASSETUP.EXE** from the **BIN** folder. Double-click the **ASSETUP.EXE** to run the CD.

3.2.2 Drivers menu

The drivers menu shows the available device drivers if the system detects installed devices. Install the necessary drivers to activate the devices.

VIA 4 in 1 drivers

This item installs the following drivers:

- VIA Registry (INF) driver
- VIA AGP VxD driver
- VIA ATAPI vendor support driver
- VIA PCI IRQ Miniport driver.

VIA 6420 RAID Controller driver

Installs the VIA 6420 RAID controller driver and application.

AD1980 SoundMAX Audio Driver

Installs the ADI 1980 AC'97 compliant audio controller and application.

USB 2.0 Driver

Installs the USB 2.0 driver to upgrade your USB 1.1 ports to USB 2.0.

Cool 'n' Quiet driver

Installs the AMD Cool 'n' Quiet!™ Technology driver.



For Windows® XP users, make sure to install Windows® XP Service Pack 1 to support USB 2.0.

3.2.3 Utilities menu

The Utilities menu shows the applications and other software that the motherboard supports.

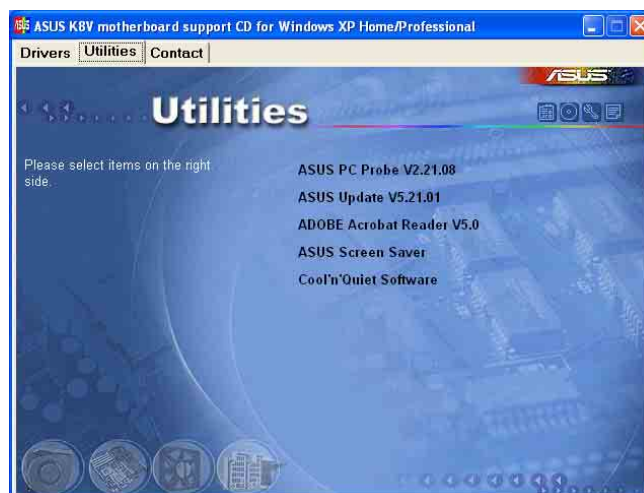

ASUS PC Probe

This smart utility monitors the fan speed, CPU temperature, and system voltages, and alerts you on any detected problems. This utility helps you keep your computer at a healthy operating condition.

Install ASUS Update

This program allows you to download the latest version of the BIOS from the ASUS website. Before using the ASUS Update, make sure that you have an Internet connection so you can connect to the ASUS website. Installing ASUS Update also installs ASUS Mylogo2™.

PC-CILLIN

Installs the PC-cillin anti-virus program. View the PC-cillin online help for detailed information.

Acrobat Reader

Installs the Adobe Acrobat® Reader V5.0. The Acrobat® Reader software is for viewing files saved in Portable Document Format (PDF).

ASUS Screen Saver

Installs the ASUS screen saver.

3.2.4 ASUS Contact Information

Clicking the ASUS Contact Information tab displays as stated. You may also find this information on the inside front cover of this user guide.



3.3 ASUS Instant Music Lite

The motherboard is equipped with a BIOS-based audio playback feature called **Instant Music Lite**. This feature is supported by the onboard audio AC'97 Codec, and requires an optical drive (CD-ROM, DVD-ROM, or CD-RW).



-
- Instant Music Lite only supports CDs in audio format.
 - Instant Music Lite does not work if you installed and enabled an add-on sound card.
 - Instant Music Lite only supports PS/2 keyboard.
-

To enable ASUS Instant Music Lite:

1. Connect the analog audio cable from the optical drive (CD-ROM, DVD-ROM, or CD-RW drive) to the 4-pin CD-In connector (labeled CD1) on the motherboard. See section “1.10 Connectors” for the connector location.



Make sure to connect the CD-ROM audio cable. Otherwise, you cannot control the audio volume using the Instant Music Lite function keys.

2. Turn on the system and enter the BIOS by pressing the **** key during the Power On Self-Tests (POST).
3. In the **Advanced Configuration** menu, select the item **Instant Music** and set it to **Enabled**. See section “2.4 Advanced Menu” in the user guide.
4. Highlight the **Instant Music CDROM** item and press Enter to display the CD-ROM options. Select the CD-ROM drive that you wish to use for this feature. See section “2.4 Advanced Menu” in the user guide.



If you have only one optical drive (either CD-ROM, DVD-ROM, or CD-RW) installed in the system, you don't have to set Instant Music CDROM item. BIOS automatically detects and displays the installed drive type.

5. Save your changes and exit BIOS Setup.



-
- The Scroll Lock LED is fixed to ON after enabling Instant Music.
 - The Caps Lock LED is turns ON when you pause the CD playback.
 - When set to Instant Music Lite mode, the system wake-up features (LAN, keyboard, mouse, USB) are deactivated. In this case, power up the system using the power switch.
 - If the system loses connection or does not detect any optical drive, the Instant Music Lite feature turns OFF (disabled) automatically. A “beep” indicates this condition.
-

To use ASUS Instant Music Lite:

1. Ensure that the power cord is plugged to a grounded power source, so that the system has a standby power.
2. Use either one of the two sets of special function keys on your keyboard to play audio CDs. These keys only function as indicated if you enabled the Instant Music item in the BIOS.

Instant Music function keys (Set 1)

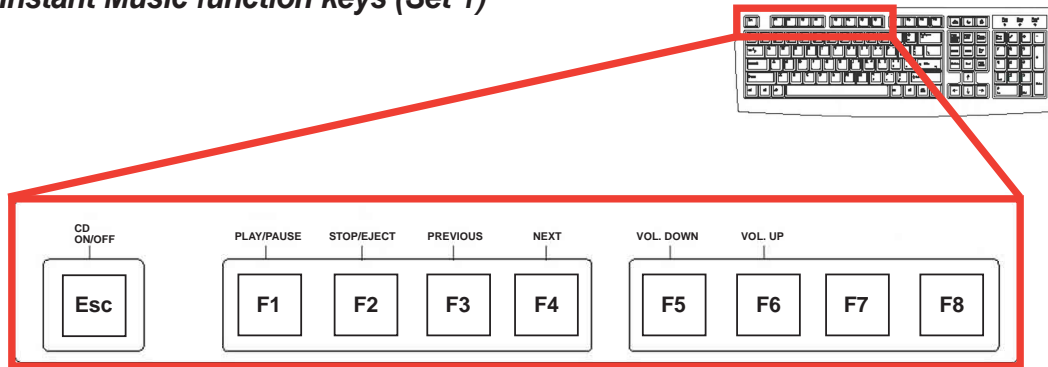

Instant Music function keys (Set 2)

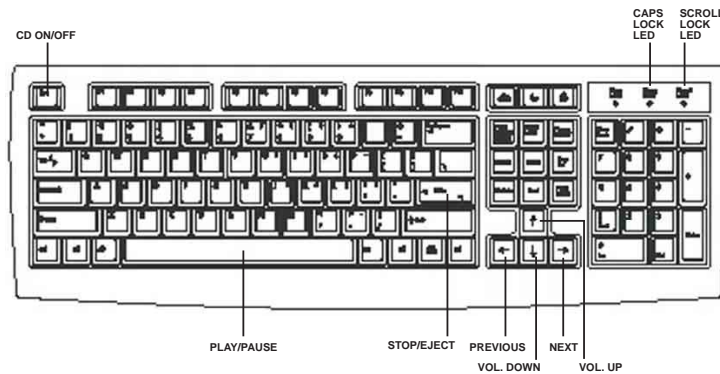

3. Connect speakers or a headphone to the Line Out (lime colored) port on the rear panel for audio output. You may also connect a headphone to the headphone jack on the CD-ROM drive front panel.
4. Press **Esc** to turn ON Instant Music Lite.
5. Place an audio CD into the drive.
6. Press **F1** or the **Space Bar** to play the first track on the CD.



If there is no CD in the drive and you press F1 or Space Bar, the drive tray ejects.

7. Refer to the Instant Music function key definitions on the previous page to select other tracks or control the volume.
8. Press **F2** or **Enter** *once* to stop playing the CD.
Press **F2** or **Enter** *one more time* to eject the CD.

3.4 VIA RAID configurations

The motherboard includes a high performance IDE RAID controller integrated in the VIA VT8237 southbridge chipset. It supports RAID 0 and RAID 1 with two independent Serial ATA channels.

RAID 0 (called *data striping*) optimizes two identical hard disk drives to read and write data in parallel, interleaved stacks. Two hard disks perform the same work as a single drive but at a sustained data transfer rate, double that of a single disk alone, thus improving data access and storage.

RAID 1 (called *data mirroring*) copies and maintains an identical image of data from one drive to a second drive. If one drive fails, the disk array management software directs all applications to the surviving drive as it contains a complete copy of the data in the other drive. This RAID configuration provides data protection and increases fault tolerance to the entire system.

3.4.1 Installing the Serial ATA (SATA) hard disks

The VIA VT8237 southbridge chipset supports Serial ATA hard disk drives. For optimal performance, install identical drives of the same model and capacity when creating a RAID set.

If you are creating a **RAID 0 (striping)** array for performance, use two new drives.

If you are creating a **RAID 1 (mirroring)** array for protection, you can use two new drives or use an existing drive and a new drive (the new drive must be of the same size or larger than the existing drive). If you use two drives of different sizes, the smaller capacity hard disk will be the base storage size. For example, one hard disk has an 80GB storage capacity and the other hard disk has 60GB storage capacity, the maximum storage capacity for the RAID 1 set is 60GB.



- Before setting up your new RAID array, verify the status of your hard disks. Make sure the Master/Slave jumpers are configured properly.
- Both the data and power SATA cables are new cables. You cannot use older 40-pin 80-conductor IDE or regular IDE power cables with Serial ATA drives. Installing Serial ATA (SATA) hard disks require the use of new Serial ATA cable (4-conductor) which supports the Serial ATA protocol and a Serial ATA power cable.
- Either end of the Serial ATA data cable can be connected to the SATA hard disk or the SATA connector on the motherboard.

Follow these steps to install the SATA hard disks for RAID configuration.

1. Install the Serial ATA hard disks into the drive bays.
2. Connect one end of the Serial ATA cable to the motherboard's primary Serial ATA connector.
3. Connect the other end of Serial ATA cable to the master Serial ATA hard disk.

4. Connect one end of the second Serial ATA cable to the motherboard's secondary Serial ATA connector.
5. Connect the other end of Serial ATA cable to the secondary Serial ATA hard disk.
6. Connect the Serial ATA power cable to the power connector on each drive.
7. Proceed to section 3.4.2 "Entering VIA Tech RAID BIOS Utility" for the next procedure.

3.4.2 Entering VIA Tech RAID BIOS Utility

1. Boot-up your computer.
2. During POST, press **<Tab>** to enter VIA RAID configuration utility. The following menu options will appear.



The RAID BIOS information on the setup screen shown below is for reference only. What you see on your screen may not exactly match what is shown here.

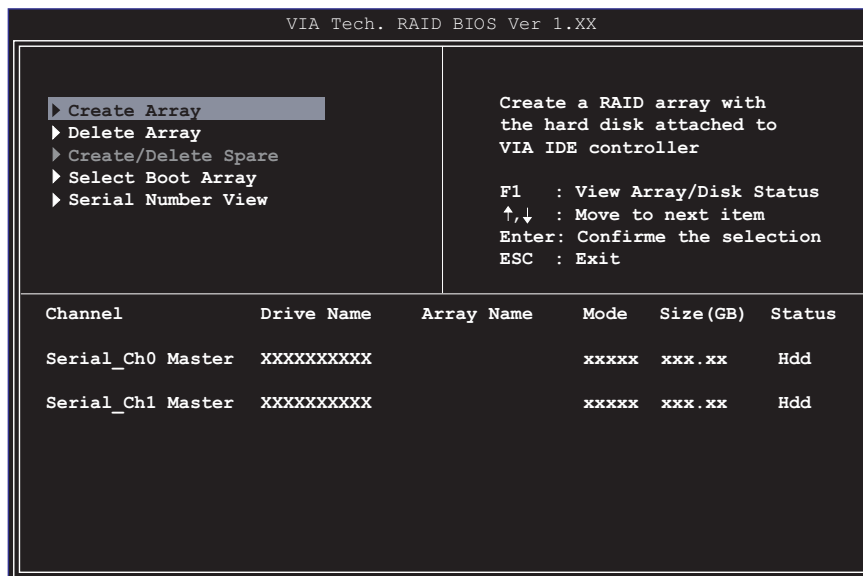

On the upper-right side of the screen is the message and legend box. The keys on the legend box allows you to navigate through the setup menu options. The message describes the function of each menu item. The following lists the keys found in the legend box with their corresponding functions.

<F1> : View Array/Disk Status
↑, ↓ : Move to the next item
<Enter> : Confirm the selection
<ESC> : Exit

3.4.3 Create Array

1. In the VIA RAID BIOS utility main menu, select **Create Array** then press **<Enter>**. The main menu items on the upper-left corner of the screen are replaced with create array menu options.

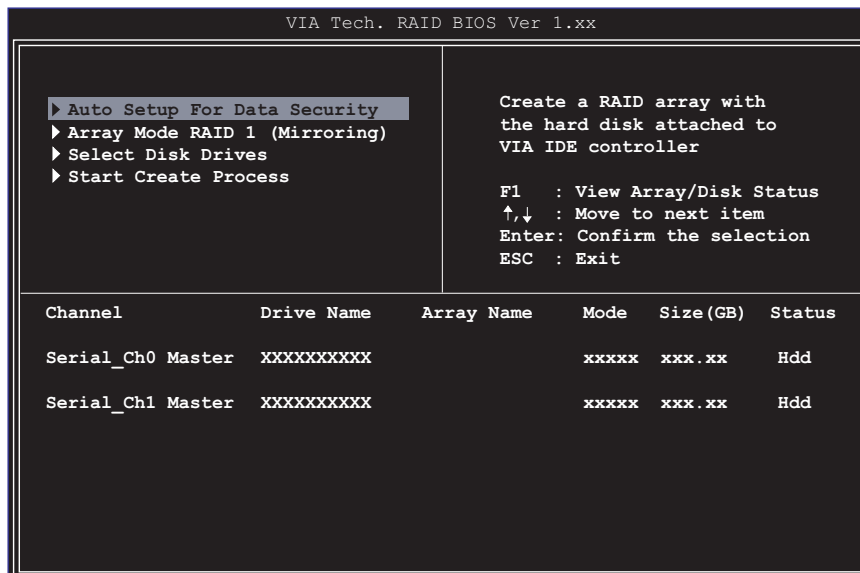

RAID 0 for performance

1. Select the second option **Array Mode**, then press **<Enter>** to display the RAID system setting pop-up menu.

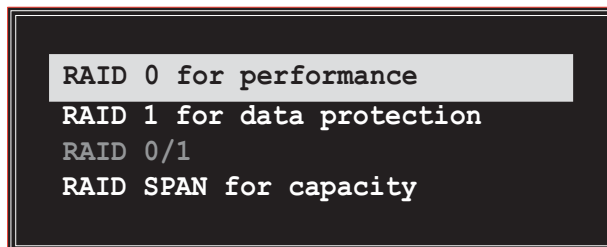

2. Select **RAID 0 for performance** from the menu and press **<Enter>**.
From this point, you may choose to auto-configure the RAID array by selecting **Auto Setup for Performance** or manually configure the RAID array for striped sets. If you want to manually configure the RAID array continue with next step, otherwise, proceed to step 5.
3. Select **Select Disk Drives**, then press **<Enter>**. Use arrow keys to select disk drive/s, then press **<Enter>** to mark selected drive. An asterisk is placed before the selected drive.
4. Select **Block Size**, then press **<Enter>** to set array block size. A list of valid array block sizes are displayed on a pop-up menu.



TIP: For server systems, use of a lower array block size is recommended. For multimedia computer systems used mainly for audio and video editing, a higher array block size is recommended for optimum performance.

Use arrow keys to move selection bar on items and press **<Enter>** to select.

5. Select **Start Create Process** and press **<Enter>** to setup hard disk for RAID system. The following confirmation message appears:

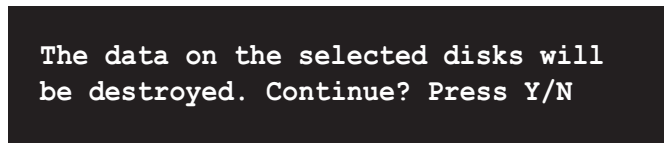

The same confirmation message appears when you select the **Auto Setup for Performance** option.

Press **<Y>** to confirm or **<N>** to return to the configuration options.

RAID 1 for data protection

1. Select the second option item **Array Mode**, then press **<Enter>**. The RAID system setting pop-up menu appears.

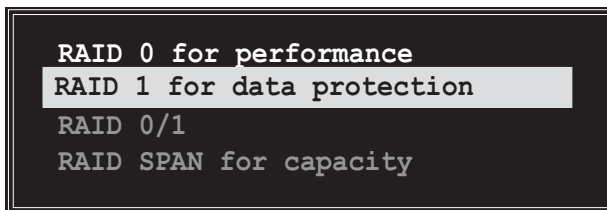

2. Select **RAID 1 for data protection** from the menu and press **<Enter>**. Select next task from pop-up menu. The task **Create only** creates the mirrored set without creating a backup. **Create and duplicate** creates both mirrored set and backup.

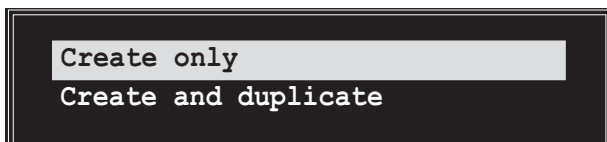

3. Select task and press **<Enter>**. The screen returns to Create Array menu items. From this point, you may choose to auto-configure the RAID array by selecting **Auto Setup for Data Security** or manually configure the RAID array for mirrored sets. If you want to manually configure the RAID array continue with next step, otherwise, proceed to step 5.

4. Select **Select Disk Drives**, then press **<Enter>**. Use arrow keys to select disk drive/s, then press **<Enter>** to mark selected drive. (An asterisk is placed before a selected drive.)
5. Select **Start Create Process** and press **<Enter>** to setup hard disk for RAID system. The following confirmation message appears:

```
The data on the selected disks will  
be destroyed. Continue? Press Y/N
```



The same confirmation message appears when you select the **Auto Setup for Data Security** option.

Press **<Y>** to confirm or **<N>** to return to the configuration options.

6. Select **Start Create Process** and press **<Enter>** to setup hard disk for RAID system. The following confirmation message appears:

```
The data on the selected disks will  
be destroyed. Continue? Press Y/N
```



The same confirmation message appears when you select the **Auto Setup for Capacity** option.

Press **<Y>** to confirm or **<N>** to return to the configuration options.

3.4.4 Delete Array

1. In the VIA RAID BIOS utility main menu, select **Delete Array** then press **<Enter>**. The focus is directed to the list of channel used for IDE RAID arrays.
2. Press **<Enter>** to select a RAID array to delete. The following confirmation message appears.

```
The selected array will be destroyed.  
Are you sure? Continue? Press Y/N
```

Press **<Y>** to confirm or **<N>** to return to the configuration options.

3.4.5 Select Boot Array

1. In the VIA RAID BIOS utility main menu, select **Select Boot Array** then press **<Enter>**. The focus is directed to the list of channel used for IDE RAID arrays.
2. Press **<Enter>** to select a RAID array for boot. The **Status** of the selected array will change to Boot. Press **<ESC>** to return to menu items. Follow the same procedure to deselect the the boot array.

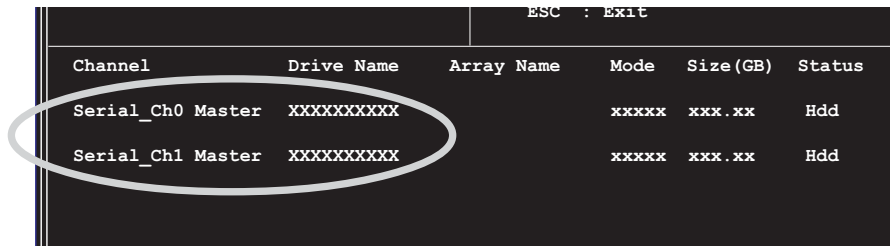

Channel	Drive Name	Array Name	Mode	Size (GB)	Status
Serial_Ch0 Master	XXXXXXXXXX		xxxxx	xxx.xx	Hdd
Serial_Ch1 Master	XXXXXXXXXX		xxxxx	xxx.xx	Hdd

3.4.6 Serial Number View

1. In the VIA RAID BIOS utility main menu, select **Serial Number View** then press **<Enter>**. The focus is directed to the list of channel used for IDE RAID arrays. Move the selection bar on each item and the serial number is displayed at the bottom of the screen. This option is useful for identifying same model disks.

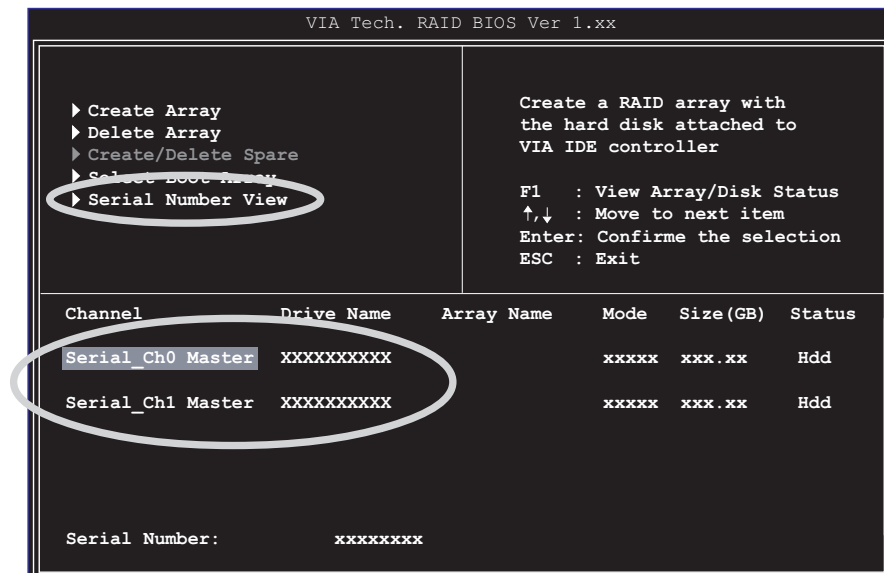

VIA Tech. RAID BIOS Ver 1.xx

▶ Create Array
▶ Delete Array
▶ Create/Delete Spare
▶ Select Boot Array
▶ **Serial Number View**

Create a RAID array with the hard disk attached to VIA IDE controller

F1 : View Array/Disk Status
↑,↓ : Move to next item
Enter: Confirme the selection
ESC : Exit

Channel	Drive Name	Array Name	Mode	Size (GB)	Status
Serial_Ch0 Master	XXXXXXXXXX		xxxxx	xxx.xx	Hdd
Serial_Ch1 Master	XXXXXXXXXX		xxxxx	xxx.xx	Hdd

Serial Number: xxxxxxxx

3.5 Promise® RAID configurations

The motherboard includes the Promise® PDC20376 controller chipset to support Redundant Array of Independent Disks (RAID) configurations. Using two Serial ATA hard disks on the PRI_SATA / SEC_SATA interfaces, and two ATA133 hard disks on the PRI_RAID interface, you may set up RAID0, RAID1, RAID0+1, and Multi-RAID configurations. Use the MBFastTrak376™ BIOS and the FastBuild™ utility to configure a disk array.

RAID 0 (called *data striping*) optimizes two identical hard disk drives to read and write data in parallel, interleaved stacks. Two hard disks perform the same work as a single drive but at a sustained data transfer rate, double that of a single disk alone, thus improving data access and storage.

RAID 1 (called *data mirroring*) copies and maintains an identical image of data from one drive to a second drive. If one drive fails, the disk array management software directs all applications to the surviving drive as it contains a complete copy of the data in the other drive. This RAID configuration provides data protection and increases fault tolerance to the entire system.



- If you use either Windows® XP/2000 operating system (OS), copy first the **Promise FastTrak 376 Driver** from the support CD to a floppy disk before creating RAID configurations.
- The chipset supports RAID 0 (striping) or RAID 1 (mirroring) for master drives only.
- The Promise PDC20376 chipset only supports one Master HDD on the Primary RAID connector. HDDs set to Slave mode and ATAPI devices such as CD-ROMs, DVD-ROMs, etc. are not supported.
- Refer to the **FastTrak 376 Quick Start Guide** and **SATA Quick Start Guide** in the support CD for detailed information on RAID configurations under different operating systems.

3.5.1 Install the hard disks

The PDC20376 chipset supports Ultra ATA/133/100/66 hard disk drives. For optimal performance, install identical drives of the same model and capacity when creating a disk array.

- If you are creating a **RAID 0 (striping)** array for performance, use two new drives.
- If you are creating a **RAID 1 (mirroring)** array for protection, you can use two new drives or use an existing drive and a new drive (the new drive must be of the same size or larger than the existing drive).

Follow these steps to install the hard disks for RAID configuration.

1. Set the jumpers of each hard disk as Master/Slave.
2. Install the hard disks into the drive bays.
3. Connect the HDD cables. These connection options are available for creating a RAID 0 or RAID 1 array:

- a. Connect two Parallel ATA HDDs to the RAID connector and one Serial ATA HDD to either one of the two Serial ATA connectors, using separate parallel ATA or serial ATA cables.
 - b. Connect one Serial ATA HDD to each Serial ATA connector, using separate serial ATA cables.
4. Connect the power cable to the power connector on each drive.
 5. Boot the system and enter the BIOS Setup Utility.
 6. Go to the **Advanced** menu in BIOS and set the appropriate IDE configuration settings.
 7. Save your changes and Exit Setup.
 8. Proceed to section 3.5.2 for the next procedure.

3.5.2 Entering the MBFastBuild™ utility

1. Boot the system.

If this is the first time you boot the system with the new hard disks installed and connect to the ATAIDE connectors on the motherboard, the MBFastTrak376™ BIOS displays the following:

```

MBFastTrak376 (tm) BIOS version 1.00
(c)2000-2005 Promise Technology, Inc. All Rights Reserved.

No Array defined...

Press <Ctrl-F> to enter FastBuild (tm) Utility
Or press <ESC> key to continue booting.

```

2. Press **<Ctrl+F>** simultaneously to display the FastBuild™ utility main menu.

```

FastBuild (tm) Utility 2.00 (c) 2002-2005 Promise Technology, Inc.
[ Main Menu ]
Auto Setup . . . . . [ 1 ]
View Drive Assignments . . . . [ 2 ]
Define Array . . . . . [ 3 ]
Delete Array . . . . . [ 4 ]
Rebuild Array. . . . . [ 5 ]

[ Keys Available ]
Press 1..5 to select Option [ESC] Exit

```

3.5.3 Creating a RAID 0 array (Performance)

1. In the FastBuild™ utility main menu, press <1> to select Auto Setup. The following screen appears.

```
FastBuild (tm) Utility 2.00 (c) 2002-2005 Promise Technology, Inc.
[ Auto Setup Options Menu ]
Optimize Array for:      Performance
[ Array Setup Configuration ]
Mode ..... Stripe
Spare Drive..... 0
Drive(s) Used in Array..... 2
Array Disk Capacity (size in MB)..... 8650
[ Keys Available ]
[ ↑ ] Up [ ↓ ] Down [ ←,→,Space ] Change Option [ ESC ] Exit [ CTRL-Y ] Save
```

2. Use the arrow keys to go to the field **Optimize Array for** and select **Performance** with the space bar. The **Mode** field displays “*Stripe*”.
3. After making a selection, press <Ctrl+Y> to save and create a RAID 0 array.
4. Press any key to reboot the system. During the boot process, the MBFastTrak376 BIOS checks and displays the disk array information.

```
MBFastTrak376 (tm) BIOS Version 1.00
(c) 2000-2005 Promise Technology, Inc. All Rights Reserved.
ID      MODE          SIZE      TRACK-MAPPING  STATUS
-----
1*      2+0 Stripe      3257M    723/192/48    Functional
Press <Ctrl-F> to enter FastBuild (tm) Utility
```

5. Once the array is created, use the FDISK utility to format the array as a single hard drive.
6. After you have formatted the arrayed drives, install an operating system (OS). The OS will treat the RAID 0 array as a single drive unit.
7. Install the RAID driver from the support CD that came with the motherboard package.



Depending on the operating system you are installing, you may need to install the RAID driver during or after the OS installation.

3.5.4 Creating a RAID 1 array (Security)

Creating a Security Array with New Drives

1. In the FastBuild™ utility main menu, press <1> to select Auto Setup.

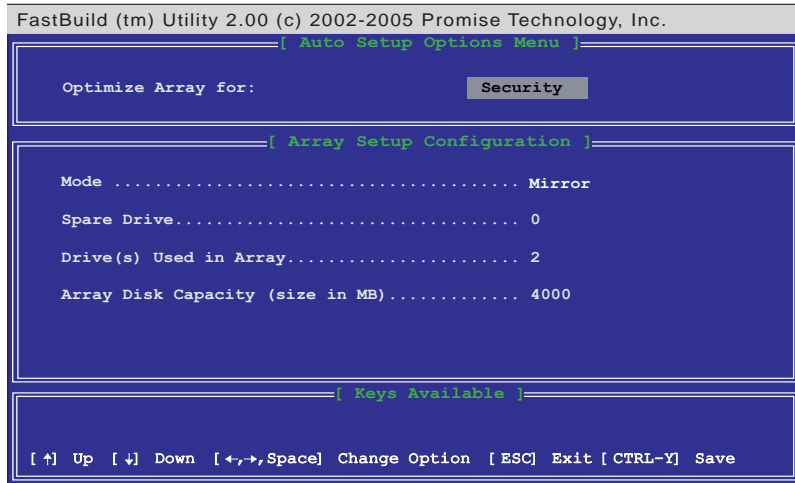

2. Use the arrow keys to go to the field **Optimize Array for** and select **Security** with the space bar. The **Mode** field displays “*Mirror*”.
3. Press <Ctrl+Y> to save your selection.
4. The following message appears:

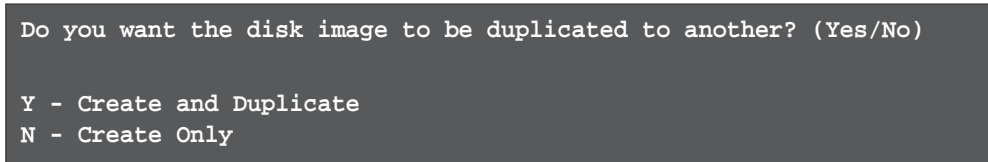

5. Press <N> for the *Create Only* option. A message appears confirming that your Security array has been created.

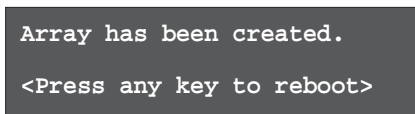

6. Press any key to reboot the system. During the boot process, the MBFastTrak376 BIOS checks and displays the disk array information.

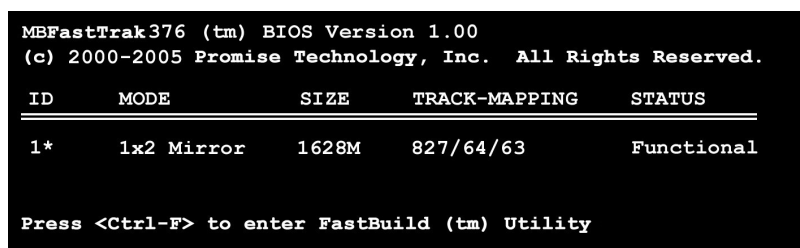

7. Use the FDISK utility and follow the format procedure for installing a new hard drive. After you have formatted the arrayed drives, install an operating system (OS).
8. Install the RAID driver from the support CD that came with the motherboard package.



Depending on the operating system you are installing, you may need to install the RAID driver during or after the OS installation.

Creating a Security Array with Existing Data Drive

If you would like to use an existing drive that already contains data and/or is the bootable drive in your system, make sure that the new hard drive you will use in the array has the same or larger capacity as the existing drive.



Backup all important data before creating an array. Failure to do so may cause data loss.

1. In the FastBuild™ utility main menu, press **<1>** to select Auto Setup.
2. Use the arrow keys to go to the field **Optimize Array for** and select **Security** using the space bar. The **Mode** field displays “*Mirror*”.
3. Press **<Ctrl+Y>** to save your selection. The following message appears:

```
Do you want the disk image to be duplicated to another? (Yes/No)
Y - Create and Duplicate
N - Create Only
```

5. Press **<Y>** for the *Create and Duplicate* option. The next window prompts you to select the source drive to use.
6. Use the arrow keys to select the source drive. The FastBuild utility will copy all the data from the source drive to the target drive.
7. Press **<Ctrl+Y>** to save the selection and start the duplication. The following message appears:

```
Start to duplicate the image...
Do you want to continue? (Yes/No)
Y - Continue    N - Abort
```

8. Press **<Y>** to continue. Press **<N>** to return to the main menu.
9. When the duplication process is completed, a message appears confirming that your Security array has been created.
10. Press any key to reboot the system.
11. Install the RAID driver from the support CD that came with the motherboard package.



Depending on the operating system you are installing (or that is already installed), the RAID driver installation sequence may vary.

3.5.5 Other FastBuild Utility Commands

Command options 3-6 on the FastBuild™ Utility main menu are not required for setting up an array, but they are useful for reconfiguring an array.

View Array (3): This command allows you to view the drive assignments of hard disks in an array.

Delete Array (4): This command deletes an array to reconfigure the system. Deleting an array does not remove information on the hard disks. If an array is deleted by mistake, recover it immediately by redefining it as the deleted array.

Rebuild Array (5): This command restores the array and system data after faults on RAID 1 arrays.

Follow these steps to rebuild and restore data in the array:

1. On boot-up, an error message notifies of a system failure.
2. Press **<Ctrl+F>** to enter the FastBuild™ Main Menu.
3. Select **<3>** for View Array to verify the ID of the defunct hard disk.
4. Power off the system and replace the hard disk with an identical model.
5. Reboot and enter the FastBuild™ Main Menu again.
6. Select **5** for Rebuild Array. The malfunctioning array is highlighted. Press **<Enter>** to select.

```

FastBuild (tm) Utility 2.00 (c) 2002-2005 Promise Technology, Inc.
[ Rebuild Array Menu ]
-----
Array No   RAID Mode   Total Drv   Capacity   Status
-----
Array 1   Mirror/Stripe   4           7999      Critical
Array 2   -----
Array 3   -----
Array 4   -----
-----

[ Keys Available ]
-----
[ ↑ ] Up [ ↓ ] Down [ ESC ] Exit [ Enter ] Select

```

7. Select the replacement drive. Press **<Enter>**.

```

FastBuild (tm) Utility 2.00 (c) 2002-2005 Promise Technology, Inc.
[ View Array Definition Menu ]
-----
Array No   RAID Mode   Total Drv   Status
-----
Array 1   Mirror/Stripe   4           Critical
-----
Stripe Block: Not Available           Gigabyte Boundary: ON
-----

[ Select Drive for Rebuild ]
-----
Channel: ID   Drive Model   Capacity (MB)
-----
3:Mas FUJITSU MPD3043AT   4325
-----

[ Keys Available ]
-----
[ ↑ ] Up [ ↓ ] Down [ ESC ] Exit [ Enter ] Select

```

8. Confirm the command to copy data from the intact source hard disk onto a new replacement hard disk. A progress gauge displays the copy progress for the duration of the task.
9. After the rebuild process is complete, the user is prompted to reboot the system.

Controller Configuration (6): This command shows the default for Controller Configuration. The default value is [Enabled].

3.6 Creating a RAID driver disk

A floppy disk with the Promise® SATA 376 or FastTrak 376 driver is required when installing Windows® XP/2000 operating system. You can create a RAID driver disk using Makedisk.exe utility.

To create a RAID driver disk:

1. Insert the motherboard support CD into the CD-ROM drive and locate the Makedisk.exe utility for your RAID controller.
 - A. The Makedisk.exe utility for the FastTrak 378 driver is located in “\Drivers\Promise\378RAID\Makedisk.exe” of the motherboard support CD.
 - B. The Makedisk.exe utility for the VIA RAID driver is located in “\Drivers\VIARAID\6420RAID\DriverDisk\Makedisk.exe” of the motherboard support CD.
2. Insert a clean floppy disk into the floppy disk drive and execute Makedisk.exe. Follow succeeding screen instructions to complete the process.
3. Write-protect the floppy disk to avoid computer virus infection.

To install the RAID driver:

1. During the OS installation, the system prompts to press the **F6** key to install third-party SCSI or RAID driver.
2. Press **<F6>** then insert the floppy disk with RAID driver into the floppy disk drive.
3. Follow the succeeding screen instructions to complete the installation.



For additional information on RAID installation and configuration, refer to the Promise® RAID installation guide found in “\Drivers\Promise\Setup” or the VIA RAID readme file found in “\Drivers\VIARAID\6420RAID\Readme.txt”.

3.7 Cool 'n' Quiet!™ Technology

The motherboard supports the AMD Cool 'n' Quiet!™ Technology that dynamically and automatically change the CPU speed, voltage and amount of power depending on the task the CPU performs.

To enable Cool 'n' Quiet!™ Technology:

1. Turn on the system and enter BIOS by pressing the **** key during the Power On Self-Tests (POST).
2. In the **Advanced -> CPU Configuration -> AMD CPU Cool & Quiet Configuration** menu, select the item **Cool N'Quiet** and set it to **Enabled**. See section "2.4 Advanced Menu" for details.
3. In the **Power** menu, select the item **ACPI 2.0 Support** and set it to **Yes**. See section "2.5 Power Menu" for details.
4. Save your changes and exit BIOS Setup.
5. Reboot your computer and set your Power Option Properties depending on your operating system.

If you are using Windows® 2000/XP operating system:

1. From the Windows® 2000/XP operating system, click the **Start** button. Select **Settings**, then **Control Panel**.
2. Make sure the Control Panel is set to Classic View.
3. Double-click the **Display** icon in the Control Panel then select the **Screen Saver** tab.
4. Click the **Power...** button. The following dialog box appears.
5. From the **Power schemes** combo list box, select **Minimal Power Management**.
6. Click **OK** to effect settings.

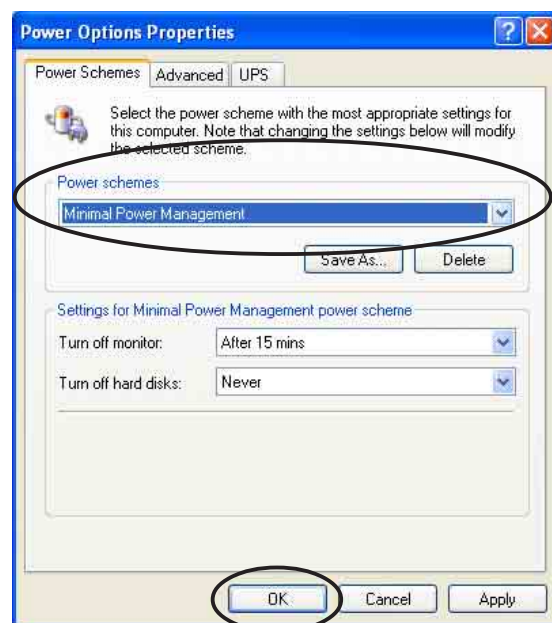

Make sure to install the Cool 'n' Quiet!™ driver and application when using this feature.

If you are using Windows® 98SE/ME operating system:

1. From the Windows® 98SE/ME operating system, click the **Start** button. Select **Settings**, then **Control Panel**.
2. Double-click the **Display** icon in the Control Panel then select the **Screen Saver** tab.
3. From the **Energy saving features of monitor** group, click the **Settings...** button.

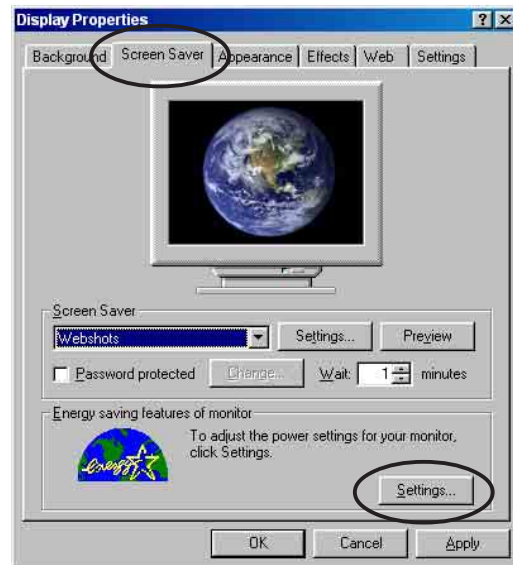

4. From the **Power Options Properties** dialog box, select the **AMD's Cool 'n' Quiet(tm) Technology** tab.
5. Click the **Performance** combo list box to select desired mode. Automatic Mode is the recommended setting.
6. Click **OK** to effect settings.

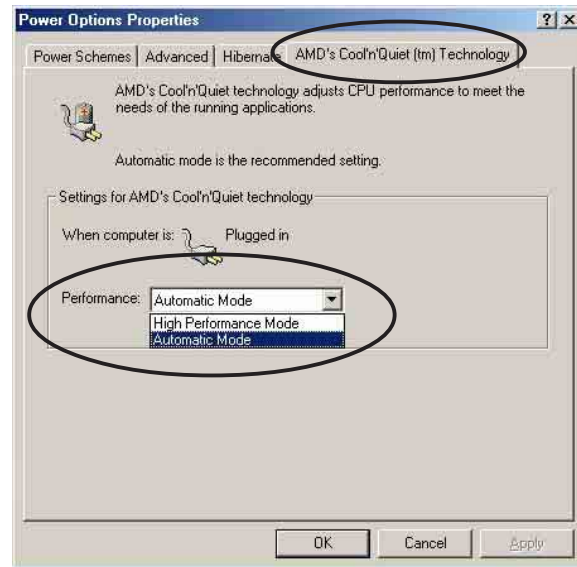

- Make sure to install the AMD Cool 'n' Quiet!™ driver and application before using this feature.
- The AMD Cool 'n' Quiet!™ Technology feature works only with the AMD heatsink and fan assembly with monitor chip.
- If you purchased a separate AMD CPU and heatsink with fan package, use the ASUS Q-Fan Technology feature to automatically adjust the CPU fan speed according to your system loading.