

Operating Instructions

Audio Mixer

WR-SX1A/32

WR-SX1A/40

WR-SX1A/48

RAMSA



WR-SX1A/48

Panasonic®

Before attempting to connect or operate this product, please read these instructions completely

Vi erklærer os eneansvarlige for, at dette produkt, som denne deklaration omhandler, er i overensstemmelse med den følgende standarder eller andre normative dokumenter i følge bestemmelserne i direktiv 89/336/EEC.

Wij verklaren als enige aansprakelijke, dat het product waarop deze verklaring betrekking heeft, voldoet aan de volgende normen of andere normatieve documenten, overeenkomstig de bepalingen van Richtlijn 89/336/EEC.

We declare under our sole responsibility that the product to which this declaration relates is in conformity with the standards or other normative documents following the provisions of Directive EEC/89/336.

Noi dichiariamo sotto nostra esclusiva responsabilità che il prodotto a cui si riferisce la presente dichiarazione risulta conforme ai seguenti standard o altri documenti normativi conformi alle disposizioni della direttiva CEE/89/336.

Ilmoitamme yksinomaisella vastuullamme, että tuote, jota tämä ilmoitus koskee, noudattaa seuraavia standardeja tai muita ohjeellisia asiakirjoja, jotka noudattavat direktiivin 89/336/EEC. säädöksiä.

Vi erklærer oss alene ansvarlige for at produktet som dette erklæringen gjelder for, er i overensstemmelse med følgende normer eller andre normgivende dokumenter som følger bestemmelsene i direktiv 89/336/EEC.

Nous déclarons sous notre seule responsabilité que le produit auquel se réfère cette déclaration est conforme à aux normes ou autres documents normatif conformément aux dispositions de la Directive 89/336/CEE.

Nosotros declaramos bajo nuestra única responsabilidad que el producto a que hace referencia esta declaración está conforme con las normas u otros documentos normativos siguiendo las estipulaciones de la directiva CEE/89/336.

Wir erklären in alleiniger Verantwortung, daß das Produkt, auf das sich diese Erklärung bezieht, mit der folgenden Normen oder normativen Dokumenten übereinstimmt.
Gemäß den Bestimmungen der Richtlinie 89/336/EEC.

Vi deklarerar härmed vårt fulla ansvar för att den produkt till vilken denna deklaration hänvisar är i överensstämmelse med standarddokument, eller andra normativa dokument som framställs i Direktiv 89/336/EEC.

For U.S.A

Warning:

This equipment generates and uses radio frequency energy and if not installed and used properly, i.e., in strict accordance with the instruction manual, may cause harmful interference to radio communications. It has been tested and found to comply with the limits for a Class A computing device pursuant to Subpart J of Part 15 of FCC Rules, which are designed to provide reasonable protection against such interference when operated in a commercial environment.

The serial number of this product may be found on the bottom of the unit.
You should note the serial number of this unit in the space provided and retain this book as a permanent record of your purchase to aid identification in the event of theft.

Model No. _____
Serial No. _____

WARNING:
TO PREVENT FIRE OR ELECTRIC SHOCK HAZARD, DO NOT EXPOSE THIS APPLIANCE TO RAIN OR MOISTURE.

Operation Procedure Quick Guide Table

Setting VCA/MUTE Group

- (1)EDIT
- (2)VCA/MUTE CHECK/SET
- (3)ON/EDIT
- (4)VCA/MUTE PROGRAMMING
ENTER

Changing VCA/MUTE Group

- (1)VCA/MUTE CHECK/SET
- (2)EDIT
- (3)ON/EDIT
- (4)VCA/MUTE PROGRAMMING
ENTER

Writing/Reading Memory

- (1)MEMORY WRITE/READ
- (2)SET MEMORY NUMBER
- (3)MEMORY ENTER

Here are brief descriptions on the operation procedures for VCA/MUTE GROUP provided on page 33 of the text. Make the most of the quick guide table by copying it and attaching the copy to a marginal area on the MASTER module if necessary.

For further detailed operation procedures for the CPU control functions, please read CPU Control Functions in the text.

CONTENTS

General.....	4
Features.....	4
General Precautions.....	5
Product Configuration.....	7
■ WR-SX1A/32	
■ WR-SX1A/40	
■ WR-SX1A/48	

Major Operating Controls and Their Functions.....	8	■ 10 VCA Group Function.....	33
■ Front Panel.....	9	■ 10 Mute Group Function.....	41
■ Rear Panel.....	10	■ 128-Pattern Memory Function.....	51
■ Monaural Input Module.....	14	■ Executing Advance.....	53
■ Stereo Input Module.....	18	■ Check Program Function.....	53
■ VCA Group Module.....	20	■ Setting Level Automation.....	54
■ Master Module.....	23	■ Setting Automation.....	55
CPU Control Functions.....	31	■ Initializing Memory.....	56
■ Setting Important Switches.....	31		

MIDI.....	57	■ MIDI One-Way Feature.....	78
■ Setting MIDI.....	57	■ Parameter Table.....	79
■ Functions and Connections.....	60	MIDI Exclusive Format.....	80
MIDI Data Format.....	63	■ Basic Format.....	80
■ Outline of MIDI Messages.....	63	■ Non-Procedure Basic Format.....	80
■ MIDI Voice Messages.....	64	■ Basic Format of Handshake.....	80
■ Parameter Table for Control Change.....	65	■ Non-Procedure Message in Handshake Format.....	81
■ MIDI Handshake Feature.....	72	■ Data Transmission Control Procedure.....	81

Module Replacement.....	84
■ Removing Modules.....	84
■ Installing Modules.....	86
Address Setting.....	88
■ Monaural / Stereo Input Module.....	88
■ VCA Group Module.....	88
Internal Switch Setting.....	89
■ Monaural Input Module.....	89
■ Stereo Input Module.....	89
■ VCA Group Module.....	90
■ Master Module.....	90
Connector Information.....	92
■ XLR Type Connector.....	92
■ Duplex Plug.....	92
■ RCA Pin Plug.....	92
■ D-sub Connector.....	93
Block Diagram.....	94
Level Diagram.....	96
Characteristics Table.....	97
Specifications.....	99
Accessory.....	100
Appearance.....	101
Troubleshooting Flowchart.....	102
Before Calling for Service.....	103

■ General

The WR-SX1 Series Audio Mixers are designed to allow the user to program, store, and recall VCA groups, mute groups, and fader levels through simple operations. With enhanced grounding performance, the WR-SX1 Series assures stable operations in rigorous noise environment in concert hall or other similar situations. It is usable as a mobile audio mixer for concert tours or events, as well as a permanent facility for event/concert halls.

■ Features

● 10 VCA Grouping Feature:

The 10VCA grouping feature allows multiple grouping in large concert events. The sound quality meets the demand from top-rated artists on concert tours.

● 10 Mute Grouping Feature:

Muting for up to 10 groups is available for each input channel and 20 AUX/GROUP main bus outs. This feature enables the director to easily control mute setting according to presentation patterns or scenes.

● Memory of 128 Patterns:

The scene memory stores up to 128 patterns of fader level setting for all inputs, channel ON/OFF status, and 20 AUX main bus outputs' ON/OFF status.

The scene control capability using ADVANCE switch and external control capability through MIDI support a wide variety of presentation patterns.

● MIDI Control:

Equipped with MIDI terminal, the WR-SX1A Series enables MIDI equipment to control the functions governed by the mixer's CPU.

● Internal Watch Dog Timer (WDT):

Should a CPU runaway occur, the WDT isolates all the inputs and AUX masters from the CPU to enable manual operations.

● Universal Concept & 22 Bus Outs:

In addition to 20 AUX/GROUP buses, 22 bus outs for L/R master bus are provided. Also with 10 matrix outs and sub-master outs, the WR-SX1 Series serves as a monitor console compatible with multiple bus outputs or as a house console.

● Quest for Realism in Sound Reproduction:

Each of the all-mono input channels is equipped with a 4-band parametric equalizer which allows for fine equalization control.

● Heavy Grounding Unique to RAMSA:

The separate grounding system proven with the WR-S840 has been further upgraded to eliminate all noise from the console itself and achieve minimum crosstalk. Clarity in sound is assured in rigorous noise environment of concert tour or similar situations.

General Precautions

● Siting

Avoid installing the equipment in the path of direct sunlight or hot air flow from a heating device. Also avoid installation in a place where the equipment will be exposed to humid air, excessive dust, or vibration.

● Induced Noise

To avoid induced noise interference, install the equipment away from a transceiver, transformer, light dimmer, or CRT monitor. Do not put the portable CD player, DAT player or Cellular telephone on this unit.

● Operation Force

Do not apply excessive operation force to the switches, volume control knobs, or fader knobs.

● Fader

Dust deposit on the fader can cause increased crosstalk or noise. If this happens, consult your dealer.

● XLR Connectors

The XLR connectors are wired as follows:

Pin 1: Shield (ground)

Pin 2: Hot (high or positive)

Pin 3: Cold (low or negative)

● Unbalance Connection

Immunity to induced noise is lowered due to the difference in ground potential. Match the ground potential among the system devices.

- Align the supply phase among the system devices.
- Unify the supply system.
- Use thick copper wires to connect ground terminals or chassis.

When the length of interconnection exceeds 10 meters, use balance cables for connections.

● Cascade Connection

Be sure to set the MASTER/SLAVE Selection switch to an appropriate position for the cascade connection.

NOTE: The D-sub 25-pin cable should be used for this connection.

● Interconnecting Cable

Be sure to use twisted 4- or 2-conductor shielded cable (4E6 or equivalent) for all connections.

● When the Internal Oscillator is Not to be Used

Be sure to leave the OSC switch OFF. Otherwise, signal leakage may result.

● Do Not Use Phantom Power Supply When:

The CD player, effector, or unbalance-type microphone is to be used. Otherwise, trouble may result.

● Memory Backup Battery

The internal memory is backed up by battery against power off. If the following message is displayed at power on, it indicates that the battery is overdischarged and requires replacement. If the battery is fully discharged, the contents of internal memory will evaporate.

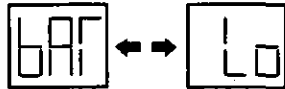

* When the equipment is to be left unused for long time period, the battery should preferably be removed from the equipment and stored in a temperature range of 0°C to 40°C to extend its lifetime.

* The battery should be replaced after every 5 years of use.

● RFI

The equipment uses digital circuitry. If the equipment is used in close vicinity of a radio or TV receiver, the receiver may sustain RF interference (noise, malfunction, etc.). Keep the equipment away from the receivers.

● MIDI

For connection to a MIDI instrument, use a cable with MIDI specs. The maximum allowable cable length is 15 meters. If the cable is extended over this length, malfunction may occur due to signal waveform distortion or induced noise.

● After Outdoor Operation

Be sure to clean all dust or dirt off the equipment before returning to the storage.

● Cleaning

- Do not use benzen or paint thinner for cleaning as it may cause deformation or discoloration.
- Use a soft, dry cloth for cleaning. For severe contamination, use a soft cloth dampened with neutral detergent and squeezed hard.

● Power Supply

- Two units of power supplies are used for this equipment. If any one of the power supplies is turned off, the CPU will stop its

Tables of Shipment-Time Function Settings

The internal switches set up on the PC board of each module can be used to change settings of various functions for this unit. The shaded fields of "Detailed switching" indicate that setting is made to them during shipment.

■ CPU control related

(1) Input-module level control during UPDATE switch being set to OFF

Detailed switching	
<input type="radio"/> Fader	
<input checked="" type="radio"/> Automation level	

(2) CPU control functions

Function	Contents of selection
Input Fader	<input checked="" type="radio"/> VALID
Level Automation	<input type="radio"/> INVALID
Channel ON/OFF Data Read function	<input type="radio"/> VALID <input checked="" type="radio"/> INVALID
VCA assignment Data Read function	<input type="radio"/> VALID <input checked="" type="radio"/> INVALID
MUTE Group Data Read function	<input type="radio"/> VALID <input checked="" type="radio"/> INVALID

For the description of functions, see page 31
For the locatin of internal switches, see page 91

■ Mono Input Module

Function	Contents of selection
AUX 13~20 Mode selection	<input type="radio"/> LEVEL/LEVEL <input checked="" type="radio"/> LEVEL/PAN
AUX 1~12(PRE) Mode selection	<input type="radio"/> PRE EQ <input checked="" type="radio"/> POST EQ
AUX 13~20(PRE) Mode selection	<input type="radio"/> PRE EQ <input checked="" type="radio"/> POST EQ

For the description of functions, see page 14
For the locatin of internal switches, see page 89

■ Stereo Input Module

Function	Contents of selection
AUX 1~12(PRE) Mode selection	<input type="radio"/> STEREO <input checked="" type="radio"/> MONO
AUX 13~20(PRE) Mode selection	<input checked="" type="radio"/> STEREO <input type="radio"/> MONO
AUX 1~12(POST) Mode selection	<input type="radio"/> STEREO <input checked="" type="radio"/> MONO
AUX 13~20(POST) Mode selection	<input checked="" type="radio"/> STEREO <input type="radio"/> MONO

For the description of functions, see page 17
For the locatin of internal switches, see page 89

■ VCA Group Module

Function	Contents of selection
AUX PFL/AFL Selection	<input type="radio"/> POST <input checked="" type="radio"/> PRE
MATRIX PFL/AFL Selection	<input type="radio"/> PRE <input checked="" type="radio"/> POST
AUX 1~12PFL.AFL MONO,ST selection	<input checked="" type="radio"/> MONO <input type="radio"/> STEREO
AUX 13~20PFL.AFL MONO,ST selection	<input type="radio"/> MONO <input checked="" type="radio"/> STEREO
Odd Number MATRIX PFL.AFL L Transmit	<input type="radio"/> OFF <input checked="" type="radio"/> ON
Even Number MATRIX PFL.AFL L Transmit	<input checked="" type="radio"/> OFF <input type="radio"/> ON
Odd Number MATRIX PFL.AFL R Transmit	<input checked="" type="radio"/> OFF <input type="radio"/> ON
Even Number MATRIX PFL.AFL R Transmit	<input type="radio"/> OFF <input checked="" type="radio"/> ON

For the description of functions, see page 20
For the locatin of internal switches, see page 90

■ Master Module

(1) L/R Master Section

Function	Contents of selection
PFL/AFL selection	<input checked="" type="radio"/> PRE <input type="radio"/> POST
SUB OUT PRE/POST selection	<input checked="" type="radio"/> POST <input type="radio"/> PRE
REC OUT PRE/POST selection	<input checked="" type="radio"/> PRE <input type="radio"/> POST

For the description of functions, see page 26
For the locatin of internal switches, see page 90

(2) TB/OSC/Monitor Section

Function	Contents of selection
Monitor system setting	<input type="radio"/> MONI <input checked="" type="radio"/> MONI/PFL·AFL
TB microphone +48V ON/OFF switching	<input checked="" type="radio"/> OFF <input type="radio"/> ON(+48V)

For the description of functions, see page 28
For the locatin of internal switches, see page 91

PRODUCT CONFIGURATION

The modules are located and configured as shown below

■ WR-SX1A/32 (32-ch)

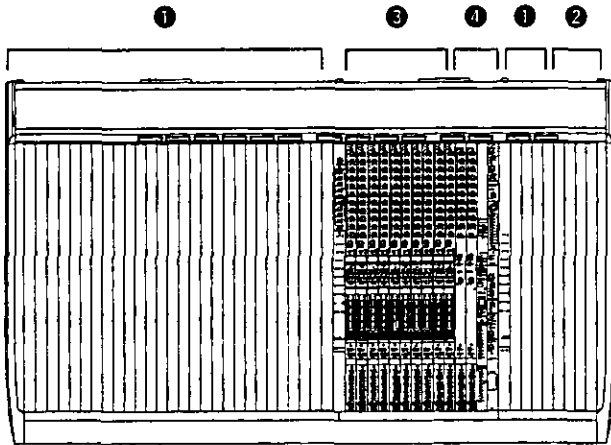

- ① Monaural input module x32
- ② Stereo input module x 4
- ③ VCA group module x 5
- ④ Master module x 1

■ WR-SX1A/40 (40-ch)

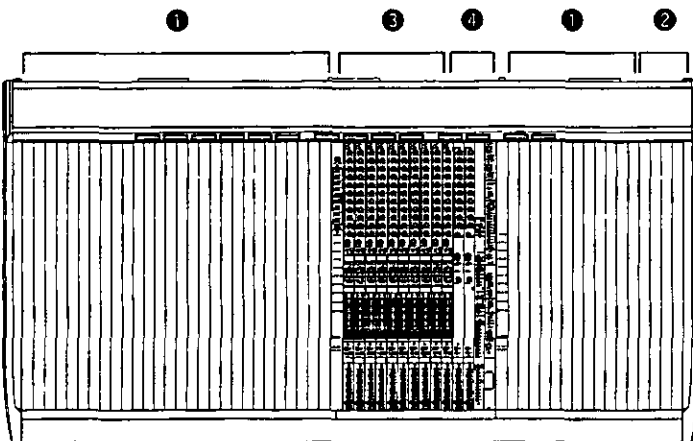

- ① Monaural input module x40
- ② Stereo input module x 4
- ③ VCA group module x 5
- ④ Master module x 1

■ WR-SX1A/48 (48-ch)

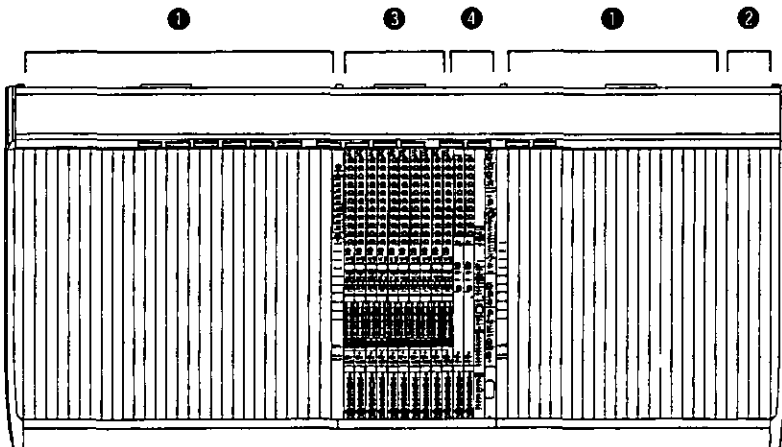

- ① Monaural input module x48
- ② Stereo input module x 4
- ③ VCA group module x 5
- ④ Master module x 1

Major Operating Controls and Their Functions

The WR-SX1A/48 is used for the illustrations in the description

■ Front Panel

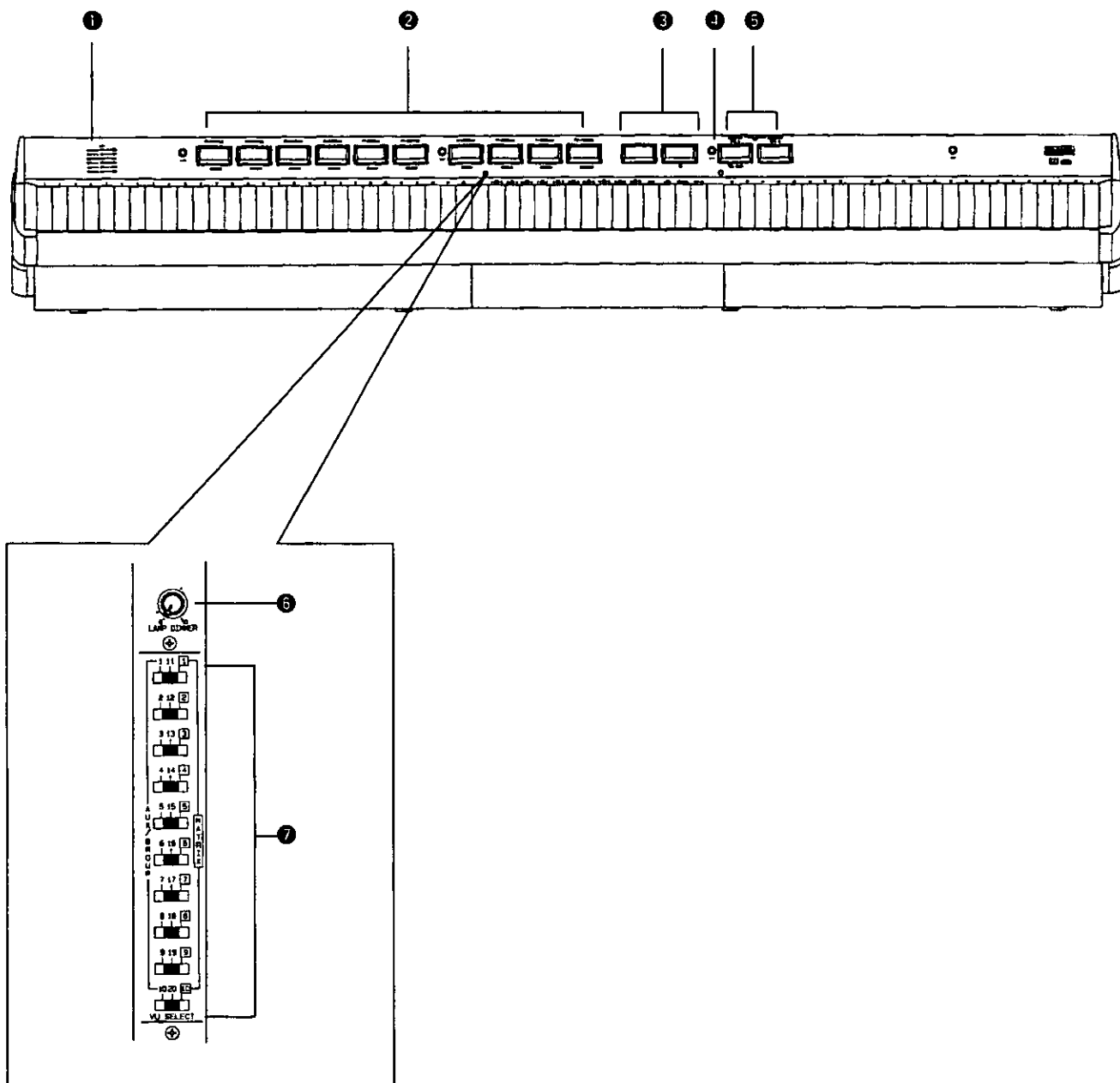

■ Front Panel

❶ POWER Indicator [POWER +25V/-25V/+15V/-15V/+48V/+12V]

These indicators indicate supply voltages from the power supply. The left-side indicator indicates POWER1, and the right-side indicator indicates POWER2.

❷ VU Meter [AUX/GROUP's 1-20, MATRIX'es 1-10]

These meters indicate AUX/GROUP (1-20) and MATRIX (1-10) signal output levels. The top LED lights in green for AUX/GROUP's 11-20, and in red for MATRIX'es 1-10.

The peak LED lights when the output signal reaches 6dB below the clip level.

❸ VU Meter [MASTER L/R]

These VU meters indicate master L/R output signal levels. The peak LED lights when the output signal level reaches 6dB below the clip level.

❹ LAMP Connector [LAMP] (BNC type)

This connector is used to supply power to a lighting fixture. Use a lamp rated at 12 VDC, 0.5 A or less.

❺ VU Meter [TB.OSC/PFL.AFL.L/R]

These meters are used to monitor TB/OSC or PFL AFL L/R signal levels. The peak LED lights when the output signal level reaches 6 dB below the clip level. Normally meter (L) show TB or OSC signal level. When the PFL or AFL switch on each module is activated, these meters show PFL or AFL L/R signal levels (top LED lights).

❻ LAMP DIMMER Control [LAMP DIMMER]

This control is used to adjust the luminance of the light connected to LAMP connector.

❼ VU Selection Switch [VU SELECT]

The left row, center row, and right row are applied to output the levels of AUX/GROUP's 1-10, AUX/GROUP's 11-20, and MATRIX'es 1-10 on VU meters, respectively.

* If the switch is located halfway between the above positions, the VU meter does not operate the needle, and the meter top LED lights in orange. In this case, set the switch again to one of the above positions.

■ Rear Panel

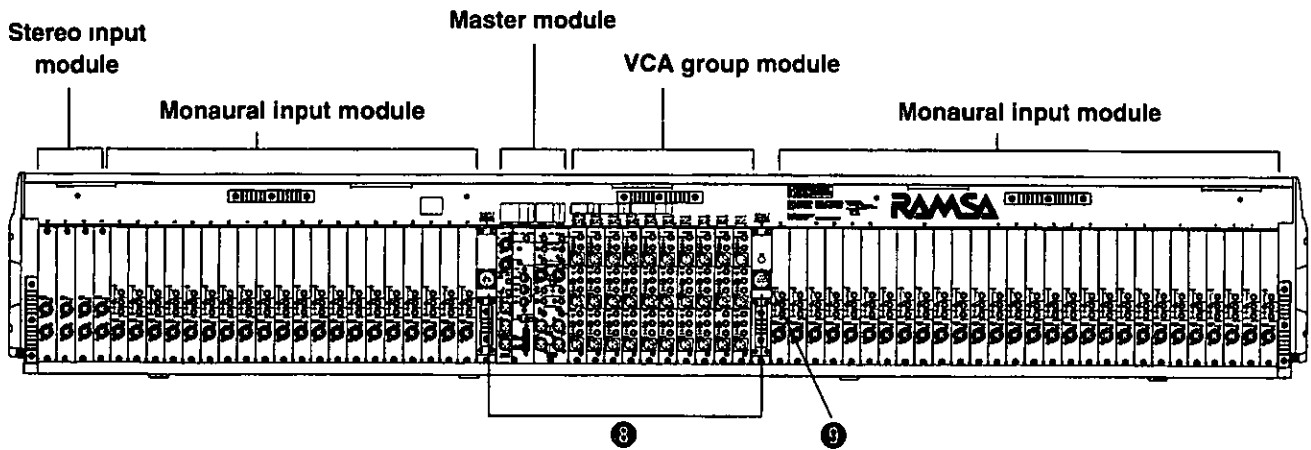

8 DC POWER Connector [DC POWER 1, 2]

These connectors are used to accept power cables from the power supply

9 Ground terminal [GND]

This is a ground terminal. Connect the ground cable when in use

● Monaural Input Module Section

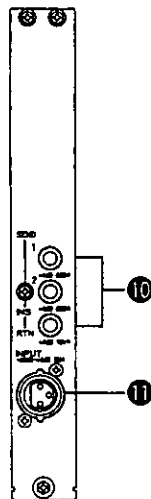

10 Insertion Connectors [INS, SEND/RTN]

These connectors are used to connect an external equipment to the signal line of each input module. These activate by turning on the Insertion switch on each input module.

- When no external equipment is connected
The signal is fed from the SEND jack to each output via the RTN jack
- When an external equipment is connected only to SEND jack
The signal is fed from the SEND jack to the external device and to each output via the RTN jack
- When an external device is connected only to RTN jack
The signal stops at the SEND jack. The signal from the external device is fed to each output via the RTN jack
- When an external device is connected across SEND and RTN jacks
The signal is fed from the SEND jack to RTN jack via the external device and to each output.
Note: When the INSERTION switch is turned off, the signal bypasses the insertion jacks regardless of whether an external equipment is connected to them or not.

11 INPUT Connector [INPUT]

This connector serves the input signal to the each module

● Stereo Input Module Section

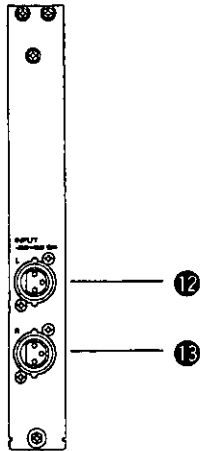

● VCA Group Module Section

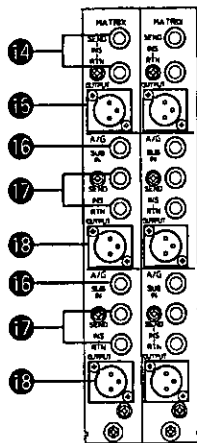

● Master Module Section

- TB/OSC/Monitor Section

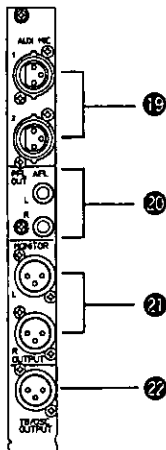

● Stereo Input Module Section

12 L CH INPUT Connector [INPUT L]

Supplies the input signal to the left channel of each stereo input module

13 R CH INPUT Connector [INPUT R]

Right channel input connector for each stereo input module Supplies the input signal to the right channel of each stereo input module

● VCA Group Module Section

14 MATRIX Insertion Connectors [SEND, RTN]

These connectors are used to connect an external equipment to the MATRIX signal line They are made available when the MATRIX Insertion switch is activated

Note The signal flows are the same as those described for the Insertion Connectors for mono input modules

15 MATRIX OUTPUT Connector [MATRIX OUTPUT]

This connector serves the matrix signal

16 AUX/GROUP SUB INPUT Connectors [AUX/GROUP SUB IN]

Auxiliary input connectors to each mixing bus for AUX/GROUP Odd-numbered channels are on the upper row, and even-numbered channels are on the lower row

17 AUX/GROUP Insertion Connectors [SEND, RTN]

These connectors are used to connect an external equipment to the AUX/GROUP signal line They are made available when the AUX/GROUP Insertion switch is activated Odd-numbered channels are on the upper row, and even-numbered channels are on the lower row

Note The signal flows are the same as those described for the Insertion Connectors for mono input modules

18 AUX/GROUP OUTPUT Connectors [AUX/GROUP OUTPUT]

These connectors are used to output AUX/GROUP signals Odd-numbered channels are on the upper row, and even-numbered channels are on the lower row

● Master Module Section

- TB/OSC/Monitor Section

19 AUX MIC INPUT Connectors [AUX MIC1, 2]

These are auxiliary microphone jacks They are chiefly used for air monitor microphones

20 PFL.AFL OUTPUT Connectors [PFL AFL OUT L/R]

These connectors output PFL or AFL signals

21 MONITOR L/R OUTPUT Connectors [MONITOR OUTPUT L/R]

These connectors output monitor signals

22 TB/OSC OUTPUT Connector [TB/OSC OUTPUT]

This connector outputs TB/OSC signal without regard to module's assign switch setting

● **Master Module Section**

- Memory Master Section

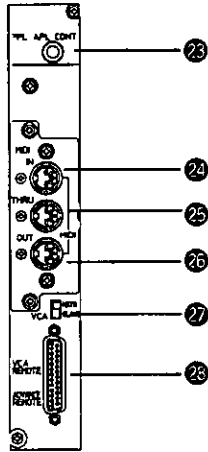

● **Master Module Section**

- Memory Master Section

②③ **PFL.AFL CONT Connector [PFL AFL CONT]**

In the Cascade Connection, when connecting the PFL AFL CONT Connector of the MASTER to one of SLAVE and the PFL AFL Output Connector of the SLAVE to the one of the MASTER, the DFL AFL signal can be confirmed from the Master

②④ **MIDI Input Terminal [MIDI IN]**

This terminal is used to control this unit from an external MIDI equipment. It is connected to the external MIDI device's output terminal.

②⑤ **MIDI Through Terminal [MIDI THRU]**

This terminal directly outputs the signal received at the MIDI input terminal from other MIDI equipment. When you wish to transfer the received signal to another MIDI device, connect the signal to this terminal and the MIDI input terminal of that MIDI device.

②⑥ **MIDI Output Terminal [MIDI OUT]**

The equipment's set data or other information is output at this terminal.

②⑦ **MASTER/SLAVE Selection Switch [MASTER/SLAVE]**

- This switch is used to determine whether this unit is to act as a master or slave one when two or more pieces of equipment are cascaded.
- When the equipment is addressed as the master, the external control terminal's VCA remote pin outputs the VCA group fader control voltage.
- When the equipment is addressed as a slave, the VCA group fader becomes ineffective, and is controlled by the voltage applied at the external control terminal's VCA remote pin.

②⑧ **External Control Terminal [VCA REMOTE/ADVANCE REMOTE]**

- Pins 1 to 10 provide VCA remote, and pin 11 provides ADVANCE remote.
- When this terminal is grounded, memory number is incremented by one and its contents are reproduced, as with the case where the ADVANCE switch is pressed. When the ADVANCE switch is pressed, this terminal is closed.

● **Master Module Section**

- L/R Master Section

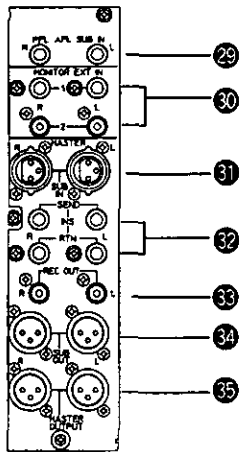

● **Master Module Section**

- L/R Master Section

②⑨ **PFL.AFL SUB Input Connectors [PFL AFL SUB IN L/R]**

Auxiliary inputs to the mixing buses for PFL or AFL (L/R)

③⑩ **MONITOR EXT IN Connectors [MONITOR EXT IN L/R]**

These connectors are provided for Monitor Selection ③⑩ Switch of TB/OSC/Monitor module

③① **SUB IN Connectors [SUB IN L/R]**

Auxiliary inputs to the mixing buses for the master (L/R)

③② **Insertion Connectors [SEND, RTN L/R]**

These connectors are used to connect an external equipment to the master's signal line. These activate by turning on the Master Insertion Switch ③②

* The signal flows are the same as those described for the INSERTION CONNECTORS for mono input module

③③ **REC OUT Connectors [REC OUT L/R]**

These connectors output the signals from the master. The signal output point can be changed with the module's internal switch

③④ **SUB OUT Connectors [SUB OUT L/R]**

These connectors output the signals from the master. The signal output point can be changed with the module's internal switch

③⑤ **MASTER OUT Connectors [MASTER OUT L/R]**

These connectors output the signals from the master

■ Monaural Input Module

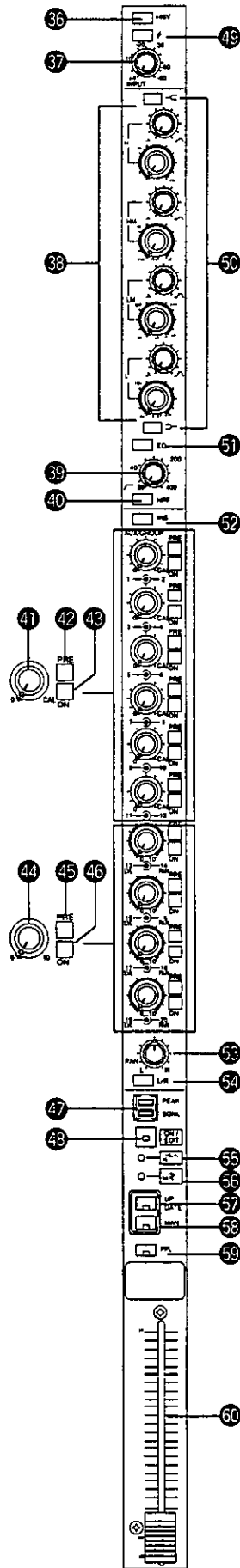

36 Phantom Power Switch [+48V]

Controls the phantom power (+48V) to the condenser microphone. Designed to prevent switch noise during ON/OFF operation.

CAUTION

Be sure to set to OFF when not using the phantom power unit

37 INPUT Level Control [INPUT]

Consecutively changes the input level from the microphone level (-60dB) to the line level (+4dB) without any keypad entry.

38 Equalizer

Provided with four stages, HIGH, HIGH MID, LOW MID, LOW. For HIGH, frequency variable peaking type of 1.6kHz to 16kHz, $\pm 15\text{dB}$, $Q = 0.5$ to 3.0 . May be set to shelving type by changing the Shelving Change Switch 39.

For HIGH MID, frequency variable peaking type of 400Hz to 8kHz, $\pm 15\text{dB}$, $Q = 0.5$ to 3.0 .

For MID LOW, frequency variable peaking type of 80Hz to 1.6kHz, $\pm 15\text{dB}$, $Q = 0.5$ to 3.0 .

For LOW, frequency variable peaking type of 40Hz to 400Hz, $\pm 15\text{dB}$, $Q = 0.5$ to 3.0 . May be set to shelving type by changing the Shelving Change Switch 39.

39 High Pass Filter Control

Cuts frequency below 20Hz to 400Hz when the HIGH PASS FILTER SWITCH 40 is on.

40 High Pass Filter Switch [HPF]

Set to ON to use the high pass filter control 39.

41 AUX Level Control [AUX1 to 12]

Controls the transmission level to AUX mixing busses 1 to 12. Provides the rated level when positioned at CAL. The inner dial corresponds to the odd channel and the outer dial indicates the even channel.

42 PRE Fader Switch [PRE]

Sends the pre-fader signal when set to ON and the post-fader signal when set to OFF. Unified switch for two ways.

43 Bus Assign Switch [ON]

Sends the signal to the AUX mixing busses 1 to 12. Unified switch for two ways.

44 AUX Level Control [13 - 20]

Controls the transmission level for the AUX mixing bus. [The AUX mixing levels 13-14, 15-16, 17-18, and 19-20 can be controlled by the inner control and the respective balance of the mixing buses 13-14, 15-16, 17-18, and 19-20 can be controlled by the outer control. By changing the internal switch of the module, inner control is for buses 13, 15, 17, and 19, and the outer control is for buses 14, 16, 18, and 20.]

45 Pre Fader Switch [PRE]

Sends the pre-fader signal when set to ON and the post-fader signal when set to OFF.

Unified switch for two ways.

46 Bus Assign Switch [ON]

Sends the signal to the AUX mixing buses 13 to 20.

Unified switch for two ways.

47 SGNL/PEAK Indicator [SGNL][PEAK]

SGNL LED (green) is lit from a value about 30dB lower than the clip level and the PEAK LED (red) is lit at a value about 6dB lower than the clip level.

48 Channel ON/EDIT Switch [ON/EDIT]

This is the main switch control for the signal sent to each mixing bus of the master (L, R) and AUX (1 to 20) (Corresponding LED is lit). It is used as the data edit switch in the edit mode of the mute group or VCA group, signal transmission ON/OFF is not changed.

49 Phase Switch [ϕ]

Changes the input signal phase.

50 Shelving Change Switch [\leftarrow][\rightarrow]

Changes between peaking type and shelving type at HIGH and LOW stages.

51 Equalizer Switch [EQ]

Changes between equalized and normal signals.

52 Insertion Switch [INS]

Set to ON to use equipment connected to the INSERTION 10.

53 PAN Pot [PAN]

Assigns the input signal to L and R.

54 Bus Assign Switch [L · R]

Sends the L and R signals assigned by the PAN POT 53 to the master L and R mixing buses.

55 CHECK/SEL Indicator [CHECK/SEL]

Lit in the edit or check mode of the mute group or VCA group.

56 LEVEL MATCH Indicator [LEVEL MATCH]

Lit green LED when the automatic level set by the CPU matches the fader level. Lit red LED when the fader level is higher than the automatic level.

57 UP DATE Switch [UP DATE]

Adds the fader level to the automatic level set by the CPU.

58 Manual Switch [MAN]

Releases the module from the CPU control. Press to enter the following status.

- VCA group/MUTE group disabled
- CPU control disabled

59 Pre Fader Listening Switch [PFL]

Set to ON to monitor the input signal before the input fader (Corresponding LED is lit).

60 Input Fader

Controls the input mode transmission level. Provides the rated level when set at 0dB. Minimum level margin is 10dB.

Signal Flowchart

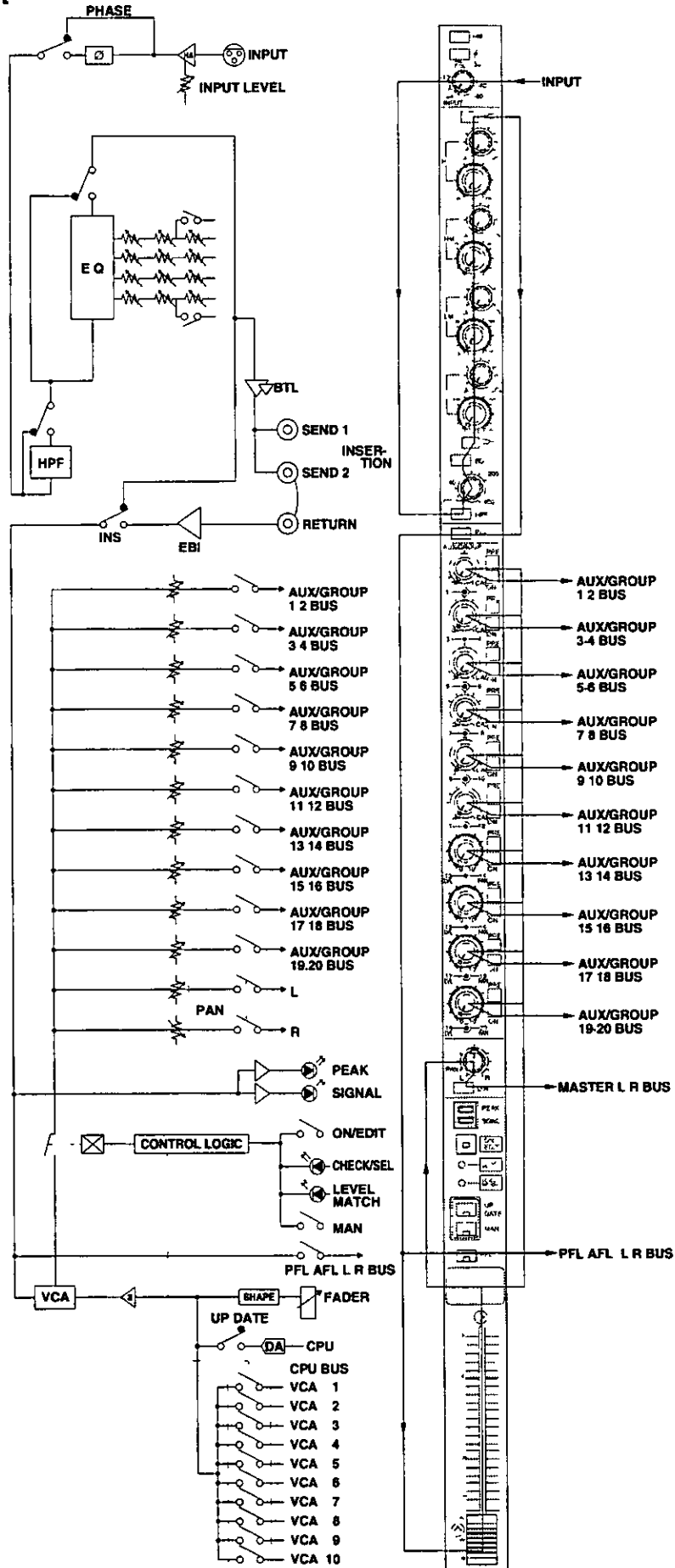

■ STEREO INPUT MODULE

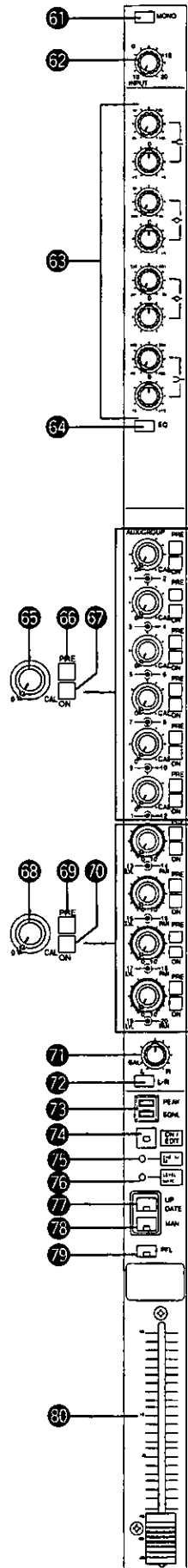

■ STEREO INPUT MODULE

61 Monaural/Stereo Switch [MONO]

Changes the stereo signal to the monaural signal.

62 Input Level Control [INPUT]

Consecutively changes the input line level (+10dB) without any keypad entry.

63 Equalizer

Provided with four stages; HIGH, MID HIGH, MID LOW, LOW.

For HIGH, frequency variable shelving type of 1.6kHz to 16kHz, ± 15 dB.

For MID HIGH, frequency variable peaking type of 400Hz to 8kHz, ± 15 dB.

For MID LOW, frequency variable peaking type of 80Hz to 1.6kHz, ± 15 dB.

For LOW, frequency variable shelving type of 40Hz to 400Hz, ± 15 dB.

64 Equalizer Switch [EQ]

Changes between equalized and normal signals.

65 AUX Level Control [1 to 12]

Controls the transmission level to AUX mixing busses 1 to 12. Usually, the stereo signal is output from this module.

By switching the Internal switch, monaural signal can be sent. Provides the rated level when positioned at CAL. The inner dial corresponds to the odd channel and the outer dial indicates the even channel.

66 Pre Fader Switch [PRE]

Sends the pre-fader signal when set to ON and the post-fader signal when set to OFF. Unified switch for two ways.

67 Bus Assign Switch [ON]

Sends the signal to the AUX mixing busses 1 to 12. Unified switch for two ways.

68 AUX Level Control [13 to 20]

Controls the transmission level for the AUX mixing bus.

Usually, the stereo signal is output from this module.

By switching the Internal switch, monaural signal can be sent. The AUX mixing levels 13-14, 15-16, 17-18, and 19-20 can be controlled by the inner control and the respective balance of the mixing buses 13-14, 15-16, 17-18, and 19-20 can be controlled by the outer control.]

69 Pre Fader Switch [PRE]

Sends the pre-fader signal when set to ON and the post-fader signal when set to OFF.

Unified switch for two ways.

70 Bus Assign Switch [ON]

Sends the signal selected by the Pre Fader Switch to the AUX mixing buses 13 to 20.

Unified switch for two ways.

71 Balance Control [BAL]

Controls the L and R transmission balance of the stereo input signal.

72 Bus Assign Switch [L/R]

Sends the L and R signals assigned by the Balance Control 71 to the master L and R mixing buses.

73 SGNL/PEAK Indicator [SGNL][PEAK]

SGNL LED (green) is lit from a value about 30dB lower than the clip level and the PEAK LED (red) is lit at a value about 6dB lower than the clip level.

74 CHANNEL ON/EDIT Switch [ON/EDIT]

This is the main switch control for the signal sent to each mixing bus of the master (L, R) and AUX (1 to 20). (Corresponding LED is lit.) It is used as the data edit switch in the edit mode of the mute group or VCA group; signal transmission ON/OFF is not changed.

75 CHECK/SEL Indicator [CHECK/SEL]

Use in the edit or check mode of the mute group or VCA group.

76 LEVEL MATCH Indicator [LEVEL MATCH]

Lit green LED when the automatic level set by the CPU matches the fader level. Lit red LED when the fader level is higher the automatic level.

77 Update Switch [UPDATE]

Adds the fader level to the automatic level set by the CPU. It is possible to add the fader level to the automatic level by changing the internal switch.

78 Manual Switch [MAN]

Releases the module from the CPU control. Press to enter the following status:

- VCA group disabled
- CPU control disabled

79 Pre Fader Listening Switch [PFL]

Set to ON to monitor the input signal before the input fader. (Corresponding LED is lit.)

80 Input Fader

Controls the input mode transmission level.

Provides the rated level when set at 0dB. Minimum level margin is 10dB.

Signal Flowchart

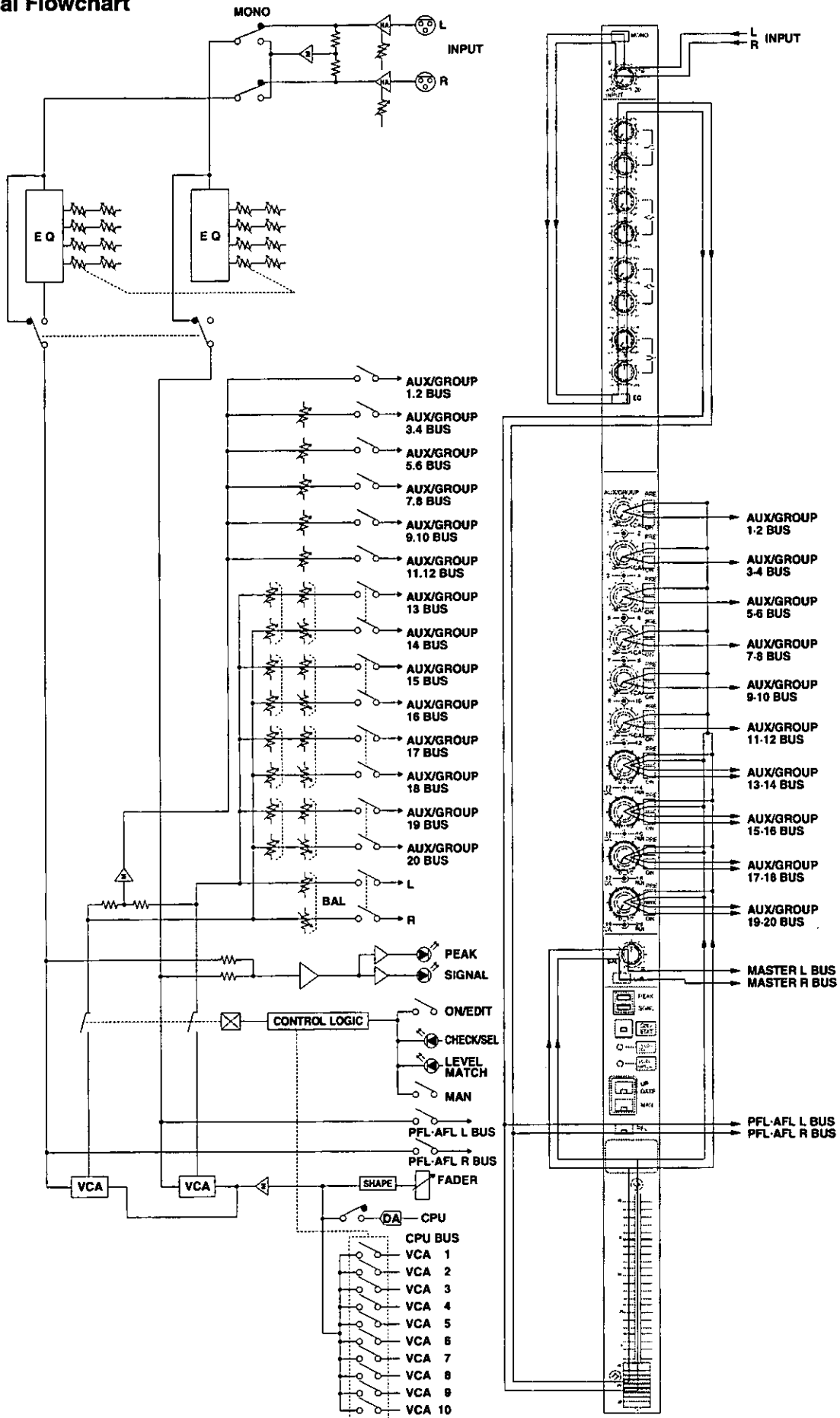

■ VCA Group Module

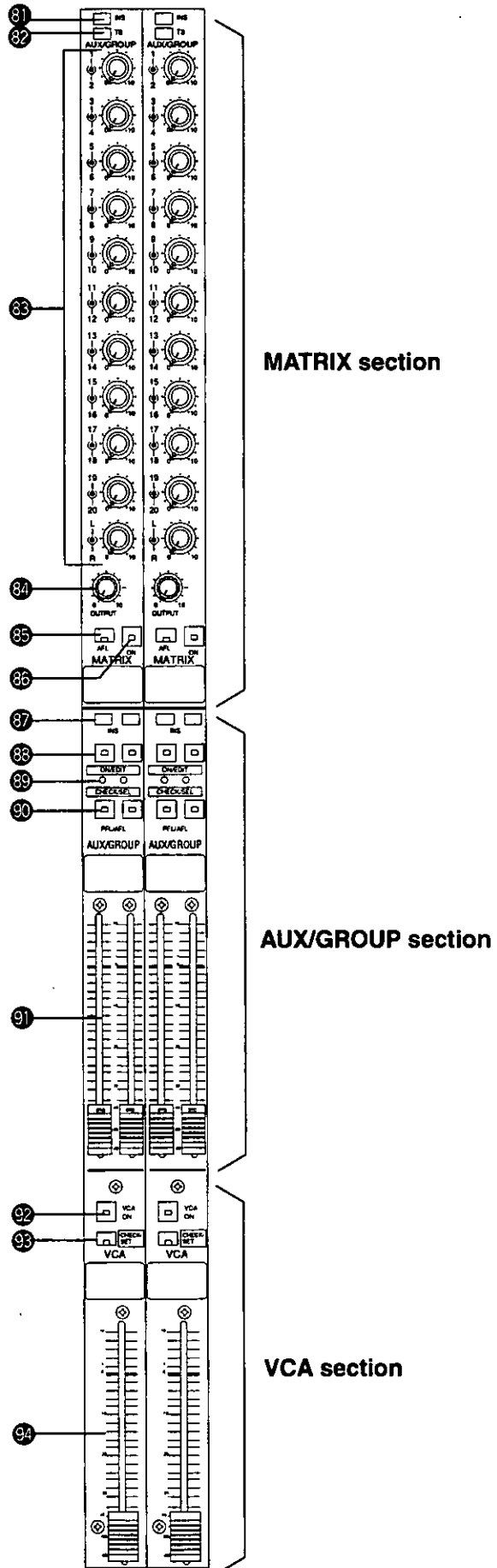

③1 Insertion Switch [INS]

Set to ON to use the equipment connected to the insertion connector on the rear panel

③2 Talk Back Switch [TB]

Enables matrix mixing of the talk-back/oscillator output.

③3 AUX/Group Level Control[AUX1-20,L/R]

Controls the AUX/GROUP 1 to 20 and L/R signal mixing levels. The inner dial corresponds to the odd channel and L, and the outer dial indicates the even channel and R.

③4 Matrix Level Control [OUTPUT]

Controls the MATRIX transmission level.

③5 After Fader Listening Switch [AFL]

Set to ON to monitor the signal after matrix level control. (Corresponding LED is lit.) Enables to change the transmission signal point using the internal switch of the module.

③6 Channel On Switch [ON]

Set to ON to send the matrix output signal. (Corresponding LED is lit.)

③7 Insertion Switch [INS]

Set to ON to use the equipment connected to the insertion connector on the rear panel.

③8 Channel On/Edit Switch [ON/EDIT]

This is the main switch to send the AUX (1-20) output signal. (Corresponding LED is lit.) It is used as the data edit switch in the edit mode of the mute group; signal transmission ON/OFF is not changed.

③9 CHECK/SEL Indicator [CHECK/SEL]

Use in the edit or check mode of the mute group.

④0 Pre Fader Listening Switch [PFL/AFL]

Set to ON to monitor the input signal before the AUX/GROUP FADER. (Corresponding LED is lit.) Enables to change the transmission signal point using the internal switch of the module.

④1 AUX/Group Fader

Controls the GROUP/AUX signal transmission level. Provides the rated level when set at 0dB. Minimum level margin is 10dB.

④2 VCA Fader On Switch [VCA ON]

Set to ON to enable the fader for the VCA-grouped input. (Corresponding LED is lit.) When set to OFF, the VCA-grouped input signal is not transmitted.

④3 VCA Group Check/Set Switch [CHECK/SET]

- Use to set, modify, or check data of VCA groups 1 to 10.
- Switch LED of the selected number is blinking during data setting and modification. When the ENTER key is pressed, the data is written to the number corresponding to the blinking LED.
- Switch LED of the selected number is lit during data check.

④4 VCA Fader

Controls the transmission level of the grouped input module. Minimum level margin is 10dB.

■ Signal Flowchart

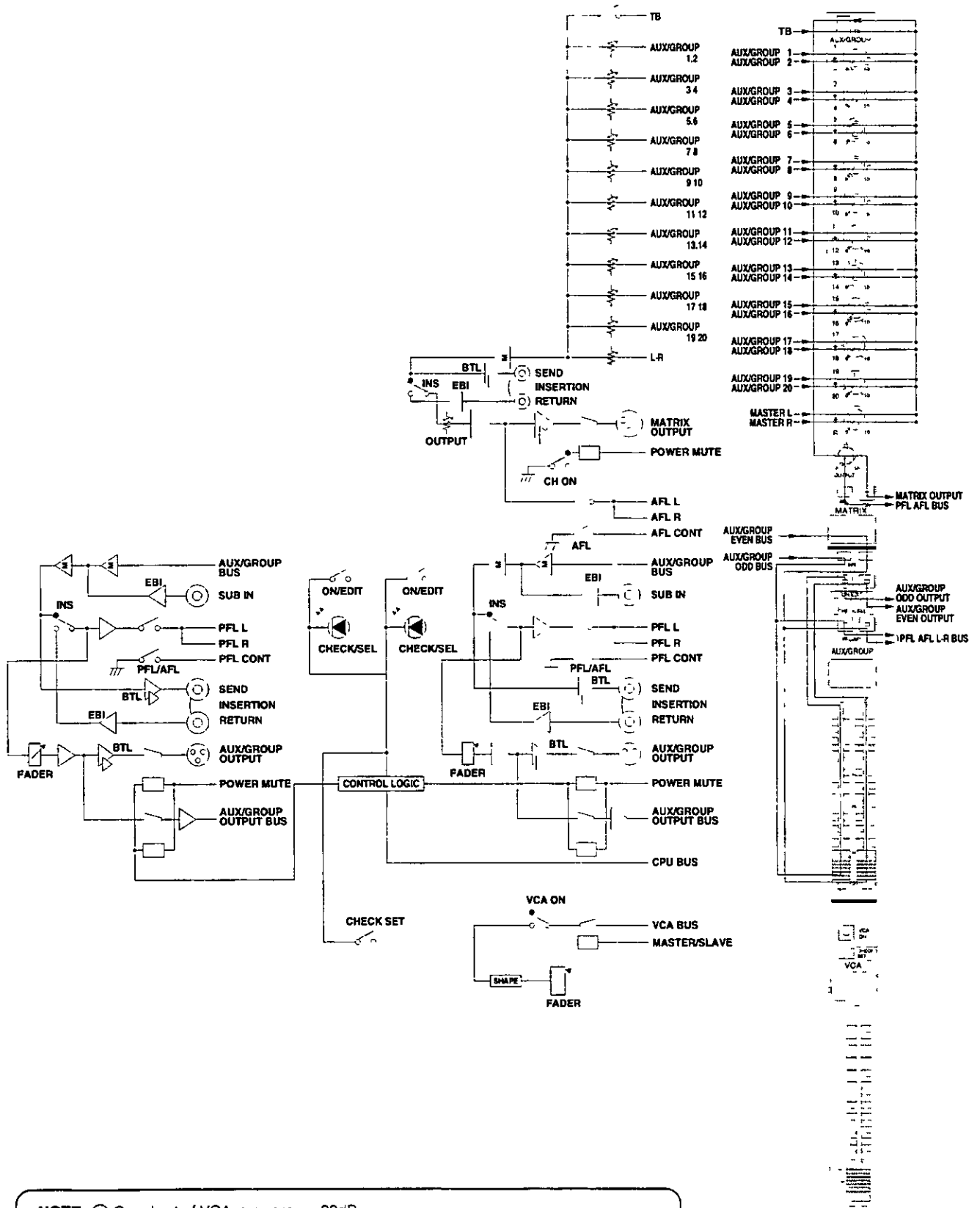

NOTE: ⊕ Gain limit of VCA is approx +22dB
 Ex) When grouping an input signal to the multiplex VCA faders, a total gain of VCA is max +22dB

■ MASTER MODULE

L/R Master Section

Memory Master Section

TB/OSC/Monitor Section

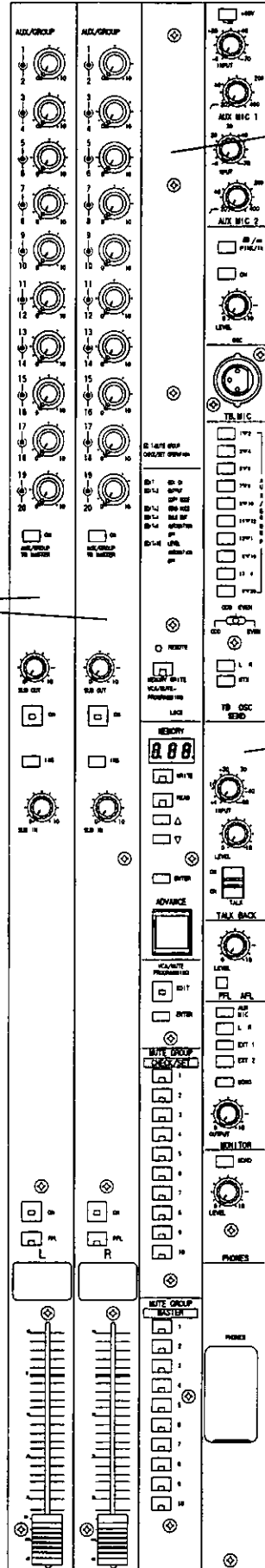

● Memory Master Section

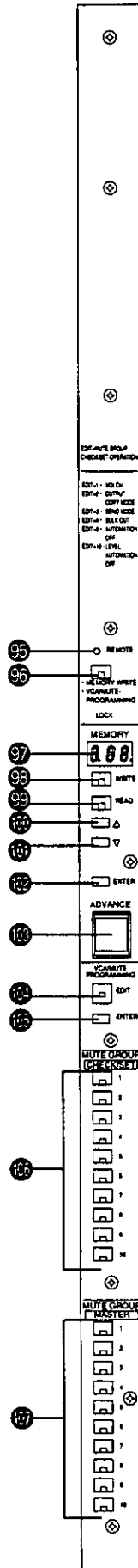

95 REMOTE Indicator [REMOTE]

Lit when controlled through MIDI from the outside.
Goes off by operating from the panel side.

96 MEMORY LOCK Switch [LOCK]

Set to ON to protect data stored in the main unit.
In the memory lock state, the corresponding LED is lit to disable the mute group and VCA group edit operation.

97 Memory Number Indicator [MEMORY]

Indicates the memory number in use.
MIDI environment and level automation ON/OFF setting contents are displayed in their corresponding mode.

98 Memory Write Switch [WRITE]

Press to store the mute group, VCA group, input fader level, CH ON/OFF status, mute group execution status in memory.
When this switch is pressed, the switch indicator blinks and the MEMORY NUMBER indicator starts blinking. In this state, set the memory number using the UP/DOWN switch or MUTE GROUP CHECK/SET SWITCH.

99 Memory Read Switch [READ]

Press to read the mute group, VCA group, input fader level, CH ON/OFF status, and mute group execution status etc. stored in memory.
The above selection is made by using the Internal switch.
When this switch is pressed, the switch indicator and the Memory Number Indicator start blinking. In this state, set the memory number using the UP/DOWN switch or Mute Group Check/Set Switch.

100 Memory Number Up Switch [▲]

When this switch is pressed while the memory number indicator is blinking in the WRITE or READ mode, the next memory number indicator starts blinking.
For MIDI environment setting, the parameter is sequentially displayed forwards.

101 Memory Number Down Switch [▼]

When this switch is pressed while the memory number indicator is blinking in the Write or Read mode, the previous memory number is indicated.
For MIDI environment setting, the parameter is sequentially displayed backwards.

102 Memory Enter Switch [ENTER]

Press to set data during memory write/read, MIDI environment setting.

103 Advance Switch [ADVANCE]

Press to read the memory number following the one in use.

104 Edit Switch [EDIT]

Use to set or modify the mute group and VCA group. (Corresponding LED is lit.)
When this switch is pressed together with the Mute Group Check/Set Switch, the MIDI environment setting and level automation ON/OFF are enabled.

105 ENTER Switch [ENTER]

Press to set data during mute group and VCA group setting and modification or MIDI environment setting.

106 Mute Group Check/Set Switch [1-10]

Use to set, modify, or check data of mute groups 1 to 10.
Switch LED of the selected number is blinking during data setting and modification. When the ENTER key is pressed, the data is written to the number corresponding to the blinking LED.
Switch LED of the selected number is lit during data check.
All switch LEDs are lit in the READ mode and WRITE mode.
Memory number can be directly input using the switches as numeric keys.

107 Mute Group Master Switch [1-10]

Executes mute groups 1 to 10.

● L/R Master Section

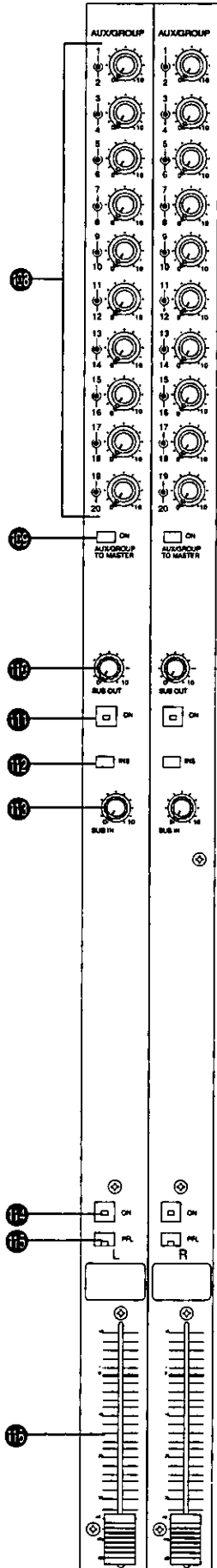

100 AUX/GROUP Level Control [AUX/GROUP 1-20]
 Controls the mixing level for the master L and R of AUX/GROUP 1 to 20.
 The internal dial corresponds to the odd channel and the outer dial indicates the even channel.

106 AUX/GROUP Mixing Switch [AUX/GROUP TO MASTER]
 Set to ON to mix the signal controlled by the AUX/GROUP level control with the master.

105 SUB OUT Level Control [SUB OUT]
 Controls the SUB OUT output level.
 Provides the rated level at the marker position. (Position of 10)
 Minimum level margin is 6dB.

107 Sub Input On Switch [ON]
 Set to ON to send the SUB OUT output signal. (Corresponding LED is lit.)

110 Insertion Switch [INS]
 Set to ON to use the equipment connected to the master insertion connector on the rear panel.

108 Sub Input Level Control [SUB IN]
 Controls the SUB INPUT input level

114 Channel ON Switch [ON]
 Set to ON to send the master output signal. (Corresponding LED is lit.)

115 Pre Fader Listening Switch [PFL]
 Set to ON to monitor the input signal before the master fader.

116 Master Fader
 Controls the master module transmission level.
 Provides the rated level at the 0dB position. Minimum level margin is 10dB.

■ Signal Flowchart

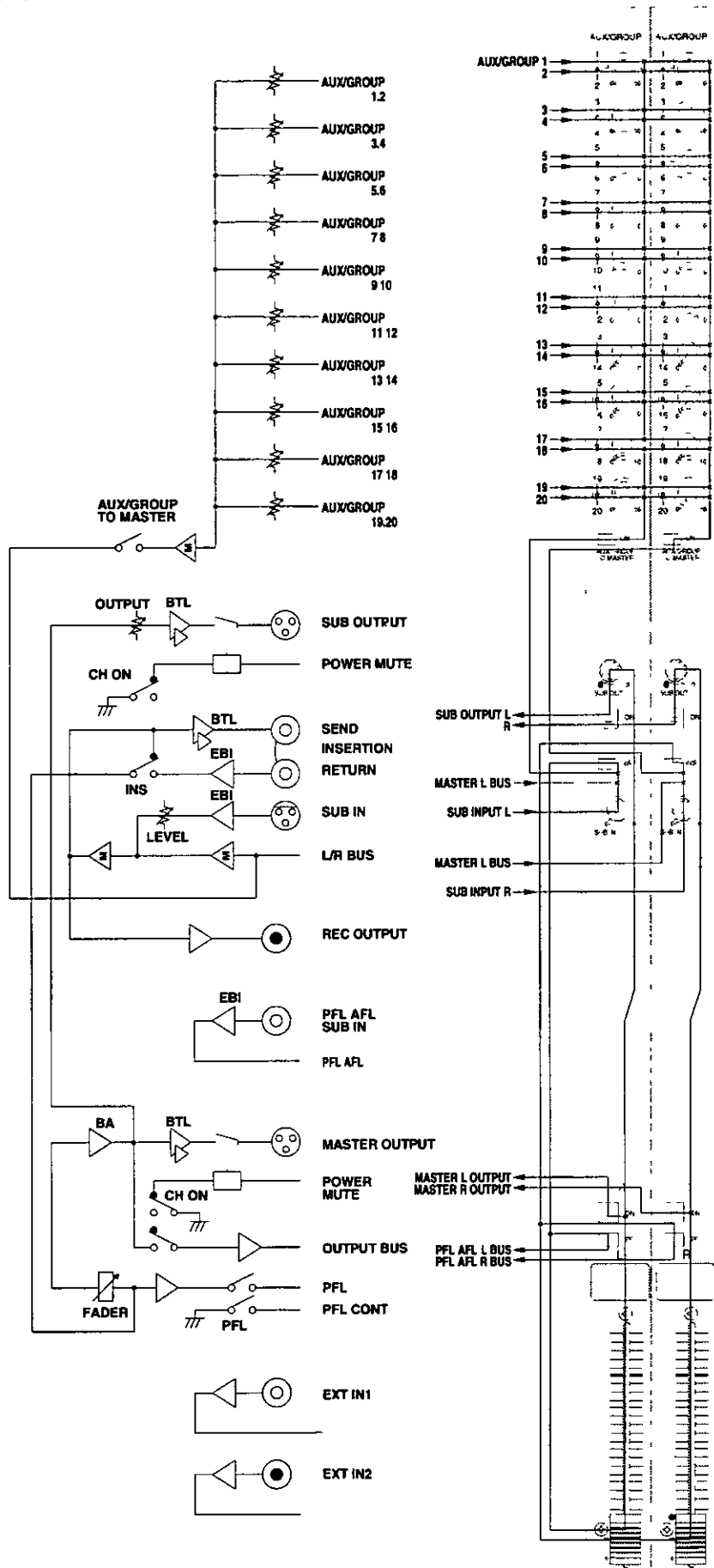

● TB/OSC/Monitor Section

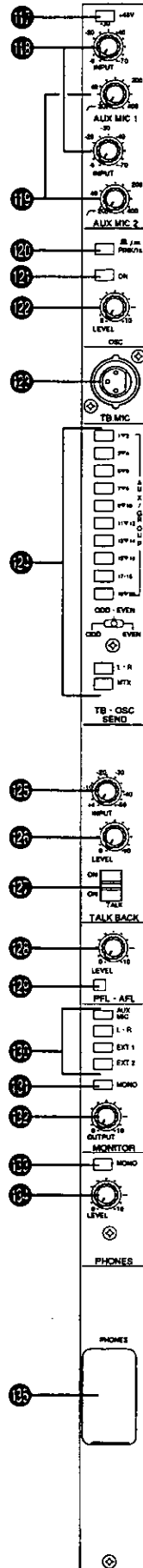

117 Phantom Power Switch [+48V]

Controls the phantom power (+48V) for the condenser microphone.
Designed to prevent switch noise during ON/OFF operation.

CAUTIONS

Be sure to set to OFF when not using the microphone with the phantom power unit.

118 AUX MIC Control [INPUT]

Controls the input level (-70dB to -6dB) of the AUX microphone input connector (air monitor microphone) on the rear panel.

119 High Pass Filter Control [HPF]

Eliminates unnecessary low frequency components of the AUX microphone from 20 to 400Hz.

120 OSC Selection Switch [PINK NOISE, 1K]

Selects the 1 kHz sine wave or pink noise as test signal (oscillator).

121 Oscillator Switch [ON]

Set to ON to send the test signal (oscillator).

122 OSC Output Level Control [LEVEL]

Controls the oscillator signal level.
Provides the rated level at the marker position. (Position of 10)
Minimum level margin is 6dB.

123 T.B.MIC Connector [T.B.MIC]

Input connector for the talk-back microphone.

124 T.B.OSC Send Switch [AUX/GROUP 1-20, L-R,MTX]

Sends the talk-back microphone or oscillator signal to AUX/GROUP 1 to 20, master L-R, and MTX.
For AUX/GROUP 1 to 20, change the transmission destination by setting the toggle switch to ODD (odd), EVEN (even), or ODD-EVEN (both odd and even).

125 T.B.Input Level Control [INPUT]

Changes the input level from -60dB to +4dB corresponding to the microphone level to the line level.

126 T.B.MIC Level Control [LEVEL]

Controls the transmission level of the talk-back microphone signal.

127 TALK Switch [TALK]

Set to the upper or lower side to enable the talk-back microphone. Set to the upper side for self-lock mode and the lower side for non-lock mode.

128 PFL•AFL Monitor Level Control [LEVEL]

Controls the signal level from the PFL or AFL switch of each module.
Provides the rated level at the marker position. (Position of 10)
Minimum level margin is 6dB.

129 PFL•AFL Monitor Indicator [PFL•AFL]

When the Pre Fader Listening Switch [PFL] or After Fader Listening Switch [AFL] on each module is pressed, this Indicator lights with the interruption to the monitor signal.

130 Monitor Selection Switch [AUX MIX, L-R,EXT1,EXT2]

Selects the master L/R, AUX microphone (air monitor microphone), or EXT1 or 2 signal to the monitor.

131 Monitor MONO Switch [MONO]

Set to ON to output the monitor output in monaural mode.

132 OUTPUT Control [OUTPUT]

Controls the monitor output signal (L/R) level.
Provides the rated level at the marker position. (Position of 10)
Minimum level margin is 6dB.

133 Head Phones MONO Switch [MONO]

Set to ON to output the headphones output in monaural mode.

134 Head Phone Level Control [LEVEL]

Controls the headphones level output.
Provides the rated level at the marker position. (Position of 10)
Minimum level margin is 6dB.

135 PHONES Connector [PHONES]

Output connector of the stereo headphones.
Use the headphones with the high impedance type of 75 to 600 ohms.

CAUTIONS

- Be sure to turn off the Oscillator Switch, which selects the OSC/TB signal, when using the Talk Back Microphone.
- The sound quality will be decreased with the sine wave signal when using the Oscillator.

■ Signal Flowchart

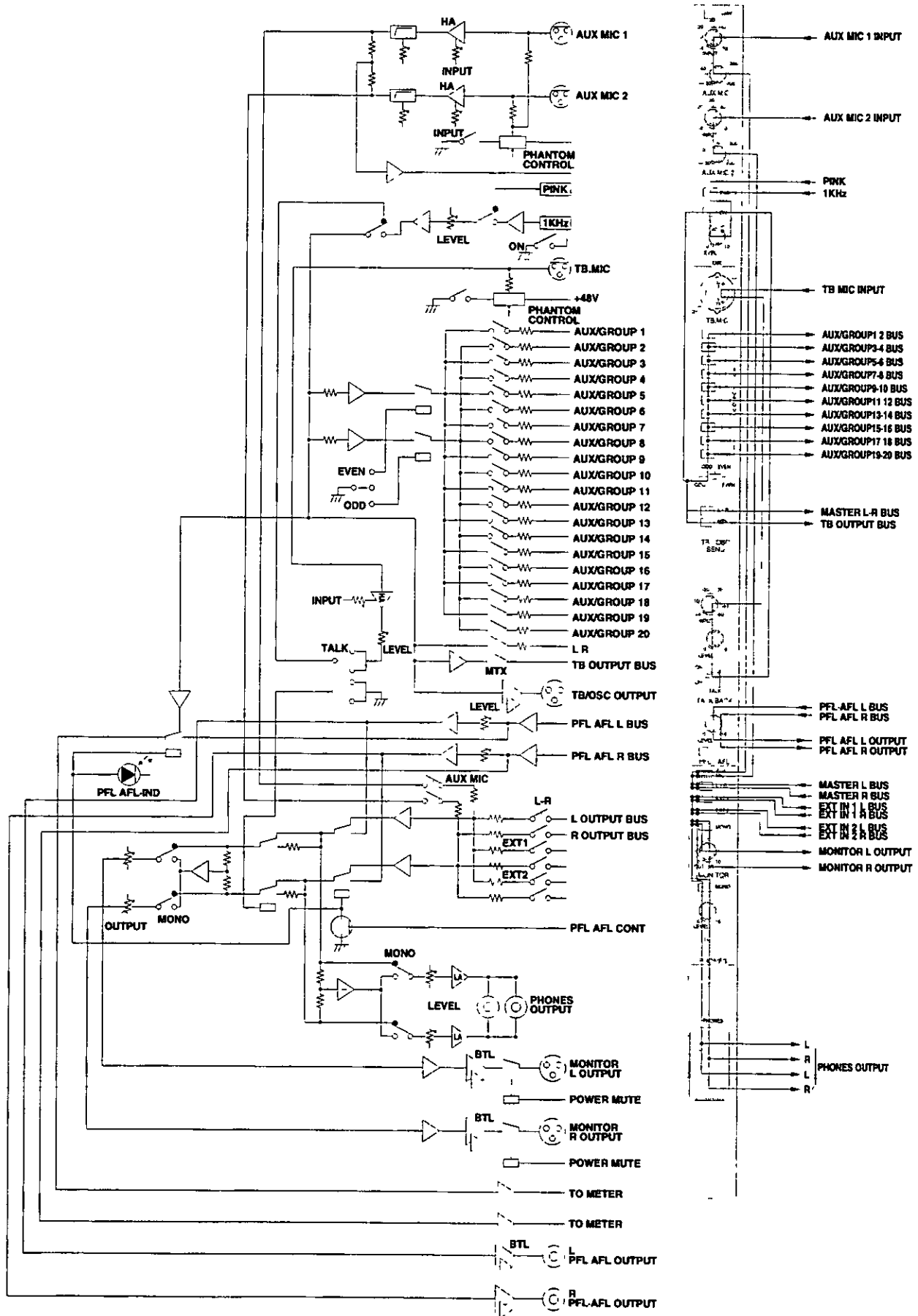

CPU Control Functions

■ Setting important switches

The important switches which affect and control CPU operations and functions are as follows. Understand the descriptions on them well, before operating them.

● CPU Enable Switch

When the CPU enable switch (SW 102) located on the CPU rear PC board is set to DIS(DISABLE), the CPU stops operation. Re-positioning this switch results in switching to the manual mode approx 4 sec later, and the MANUAL switch LED lights for all input modules.

For module operation status, see MANUAL-switch descriptions (page 32).

● Operation-mode Setting Switches

You can set the operation-mode of the CPU of this equipment as follows, by switching the operation-mode setting switches (SW101) that you can find on the CPU rear board. See page 91 for the location of the switches. The status of these switches is read by the CPU during powering on.

Make sure that the power is shut off when you change the settings.

No	Item to be set	ON	OFF	Default setting
1	Connection of VCA group	During memory read, VCA group connection is invalidated. While the VCA group data are stored, these data are not read during memory read and all VCA groups are treated as non-assigned. Panel operations after memory read and VCA group settings by MIDI communication are valid.	During memory read, VCA group connection is validated.	OFF
2	VCA group assignment read	During memory read, VCA group assignment data are read and the current assignment is changed.	VCA group assignment data are not read during memory read and the current assignment is held.	OFF
3	MUTE group master execution number data read	During memory read, MUTE group master execution number data are read and this number is executed.	The MUTE group master execution number data are not read during memory read, and the current execution number is held.	OFF
4	Channel ON/OFF data read	During memory read, data as to ON/OFF status of input module and AUX group and the current ON/OFF status is changed.	The data as to ON/OFF status of the input module and AUX group are not read during memory read, and the current channel ON/OFF status is held.	OFF
5	MUTE group data read	During memory read, the MUTE group data are read and the current 10MUTE group is changed.	The MUTE group data are not read during memory read, and the current 10MUTE group is held.	OFF
6	Input module level control switch	The level is usually controlled by the input fader. When the UPDATE switch is pressed, the automation level from the CPU is added to this level. The VCA groups are valid.	The level is usually controlled by the automation level from the CPU. When the UPDATE switch is pressed, the input fader level is added to this level. The VCA groups are valid.	OFF
7	Input module write-level control switch	During memory read, the addition of input fader level and the CPU automation level is stored.	Only the input fader level (fader position) is stored during memory write.	OFF
8	Memory read duration switch	Data in the memory are read at a normal rate (130msec).	The read-out rate up to completion is accelerated from the normal rate by approx 40msec (see NOTE below for this setting).	ON

Note

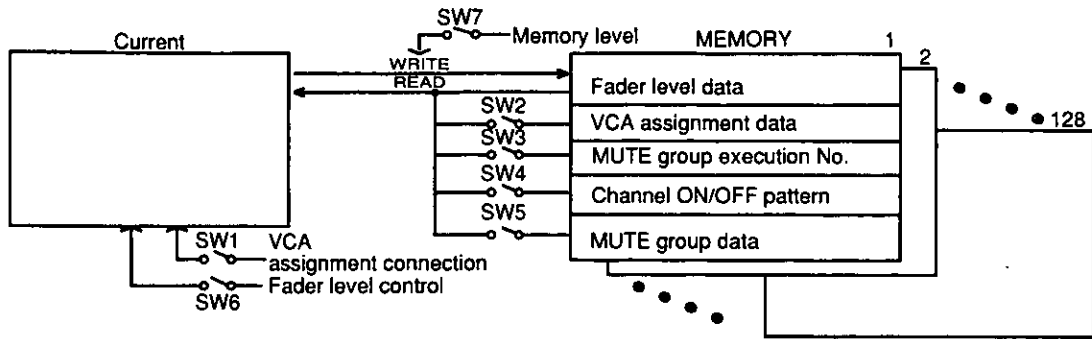

- The setting of 1 overrides that of 2. If 1 is set to ON, therefore, the VCA assignment data are not read, even when 2 is ON.
- When read-out for 3, 4 and 5 are all enabled, the read-out process is executed in the sequence of 5 → 3 → 4. On the completion of read-out, therefore, the setting of 4 is the priority status.
- When the following pattern change (memory read-out) is performed with the 8 set to OFF, voice in the input module may momentarily leaked.

	Input module channel ON/OFF setting	VCA group setting
Pattern A	OFF	Not assigned
Pattern B	ON	Assigned, with the VCA fader set to ∞ or the VCA ON switch off.



● LOCK Switch

This prevents the individual data contents of 10-VCA group, 10-MUTE group, and 128-pattern memory from being changed.

- 1**  **Press** The LOCK switch indicator lights. The MEMORY WRITE/VCA/MUTE PROGRAMMING EDIT switch is disabled.
- 2**  **Press** To reset the locked status, press the LOCK switch again. The indicator goes off, and the locked status is reset.



Master-module
Memory-master unit

Note

When locking is ON, MUTE-group execution, VCA group/MUTE group checking, memory read, and data modification with MIDI communication are allowed.

● MANUAL Switch

When the mono-/stereo-input module MANUAL switch is pressed, the corresponding module is put in the following status.

Item	Status
UPDATE switch indicator	The status is as follows, depending on the setting of the operation-mode setting switch No. 6. 6 is ON: The indicator does not turn on when the UPDATE switch is pressed. 6 is OFF: The indicator stays on regardless of the status of the UPDATE switch, and the level control is switched from automation level control by the CPU to fader control.
VCA/MUTE group	Disabled. CHECK/SEL indicator will not light/flash either and setting, confirmation, modification are all disabled.
Pattern memory function	Therefore the ON/EDIT switch can only be used for ON/OFF change. Read and write are both disabled.

Note





When the MANUAL switch is released, the channel ON/OFF status before the release is held and the automation level is restored to the level before the pressing of the switch.
However, when the automation level setting is changed by memory read-out, MIDI communication and so on, while the MANUAL switch is pressed, the level is set to the new setting value.

CPU Control Functions

■10-VCA group function

This sets the connection status of input modules (channels) to 10 VCA's.

●VCA-group setting

-
- | | | |
|----------|---|--|
| 1 | <p>VCA/MUTE
PROGRAMMING</p>  <p>EDIT</p> <p>Press</p> | <p>The EDIT switch indicator blinks. The ON/EDIT switch for individual input modules and AUX 1~20 is prohibited from channel setting and, instead, functions as a data input switch.</p> |
| <hr/> | | |
| 2 | <p><p>CHECK/
SET</p><p>Press</p></p> | <p>Press the CHECK/SET switch for the setting-target VCA group number. The indicator on the pressed switch blinks, and the CHECK/SEL indicator on AUX 1~20 changes the status from blinking to going off. This status is called "VCA Edit Status."</p> |
| <hr/> | | |
| 3 | <p><p>ON/
EDIT</p><p>Press</p></p> | <p>This sets VCA group assignment. The CHECK/SEL indicator blinks on those input modules having assignment status turned on. Every press of the ON/EDIT switch alternates the blinking and going-off status of the CHECK/SEL indicator.</p> |
| <hr/> | | |
| 4 | <p><p>ENTER</p><p>Press</p></p> | <p>This registers VCA assignment data, and completes setting.</p> |
| <hr/> | | |
| 5 | <p><p>CHECK/
SET</p><p>Press</p></p> | <p>Press the CHECK/SET switch for the VCA group number set. The indicator on that switch lights, and the CHECK/SEL indicator lights on those input modules having assignment. To finished confirmation, press the CHECK/SET switch again.</p> |
-

Note

- Operation Steps 2 and 3 can be in the reversed order.
- Batch-mode setting is not allowed. Make setting on a one-by-one basis in accordance with the above procedure.
- During the VCA Edit status, pressing a switch other than the CHECK/SET, VCA/MUTE PROGRAMMING ENTER, and ON/EDIT switches resets that status. Then, the operation determined by pressing that switch is performed.

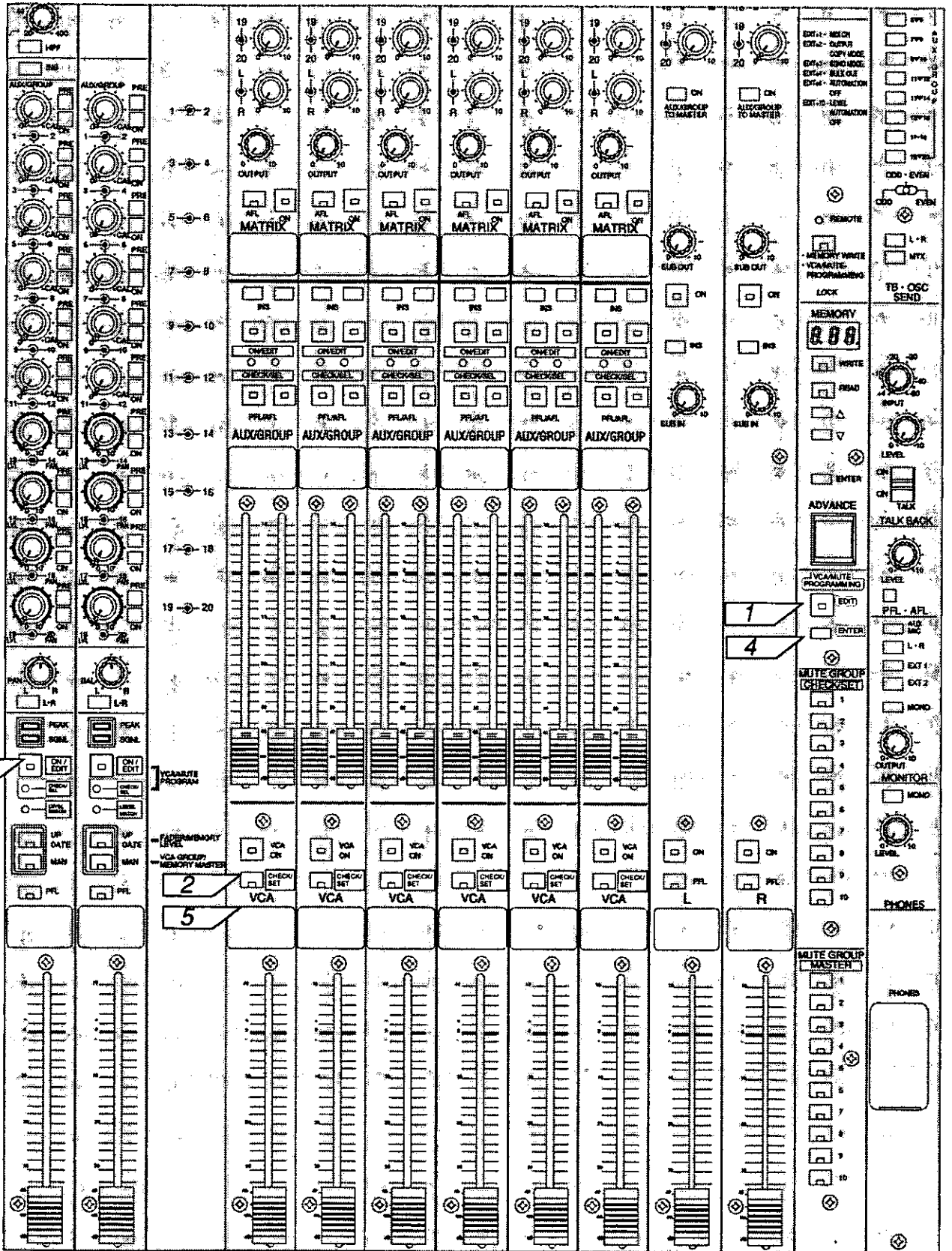

● Modifying preset data

1  **CHECK/
SET**
Press

Press the CHECK/SET switch for the modification-target number. The indicator on the pressed switch lights, as well as the CHECK/SEL indicator on VCA group-assigned input modules.

2  **VCA/MUTE
PROGRAMMING
EDIT**
Press

The indicator on the EDIT switch blinks. The lighting CHECK/SET-switch indicator and input-module CHECK/SEL indicator turn to blinking.

3  **ON/
EDIT**
Press

This modifies VCA group assignment. The "assignment-ON" input-module CHECK/SEL indicator blinks. Every press of the ON/EDIT switch alternates the blinking and going-off status of the CHECK/SEL indicator.

4  **ENTER**
Press

This modifies and registers VCA assignment data, and completes setting.

5  **CHECK/
SET**
Press

Press the CHECK/SET switch for the VCA group number modified. The indicator on that switch lights, and the CHECK/SEL indicator lights on those input modules having assignment. To finished confirmation, press the CHECK/SET switch again.



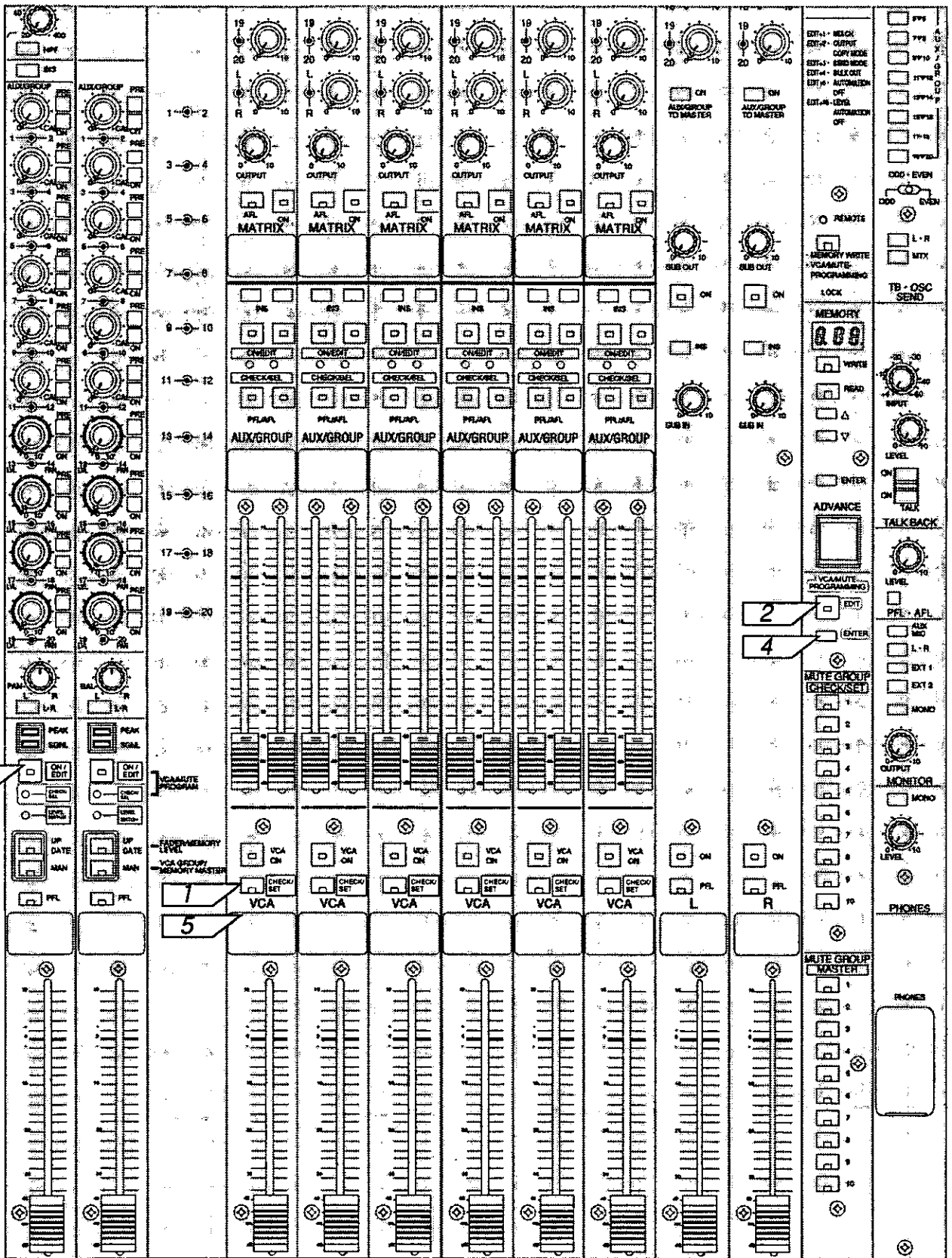

Note

- In Step 2, the ON/EDIT switch for each input module and AUX 1~20 is prohibited from channel ON/OFF setting and, instead, functions as a data input switch. However, since VCA-group modification is assumed in that status, pressing the AUX-1~20 ON/EDIT switch makes no change in status of the CHECK/SEL indicator.
- Batch-mode setting is not allowed. Make setting one by one as instructed in the above procedure.



CPU Control Functions

●Copying preset data

-
- 1**  CHECK/
SET
Press
- Press the CHECK/SET switch for the copying-target number. The indicator on the pressed switch lights, as well as the CHECK/SEL indicator on VCA group-assigned input modules.
-
- 2**  VCA/MUTE
PROGRAMMING
EDIT
Press
- The EDIT-switch indicator blinks. The lighting CHECK/SET-switch indicator and input-module CHECK/SEL indicator turn to blinking.
-
- 3**  CHECK/
SET
Press
- Press the CHECK/SET switch for the copying-destination number. The indicator on the pressed switch blinks. The CHECK/SEL indicator status remains unchanged. To modify data in copying, press the ON/EDIT switch while in this status.
-
- 4**  ENTER
Press
- This copies VCA assignment data, and completes setting.
-
- 5**  CHECK/
SET
Press
- Press the CHECK/SET switch for the copying-destination number. The indicator on that switch lights, and the CHECK/SEL indicator lights on those input modules having assignment. To finished confirmation, press the CHECK/SET switch again.
-



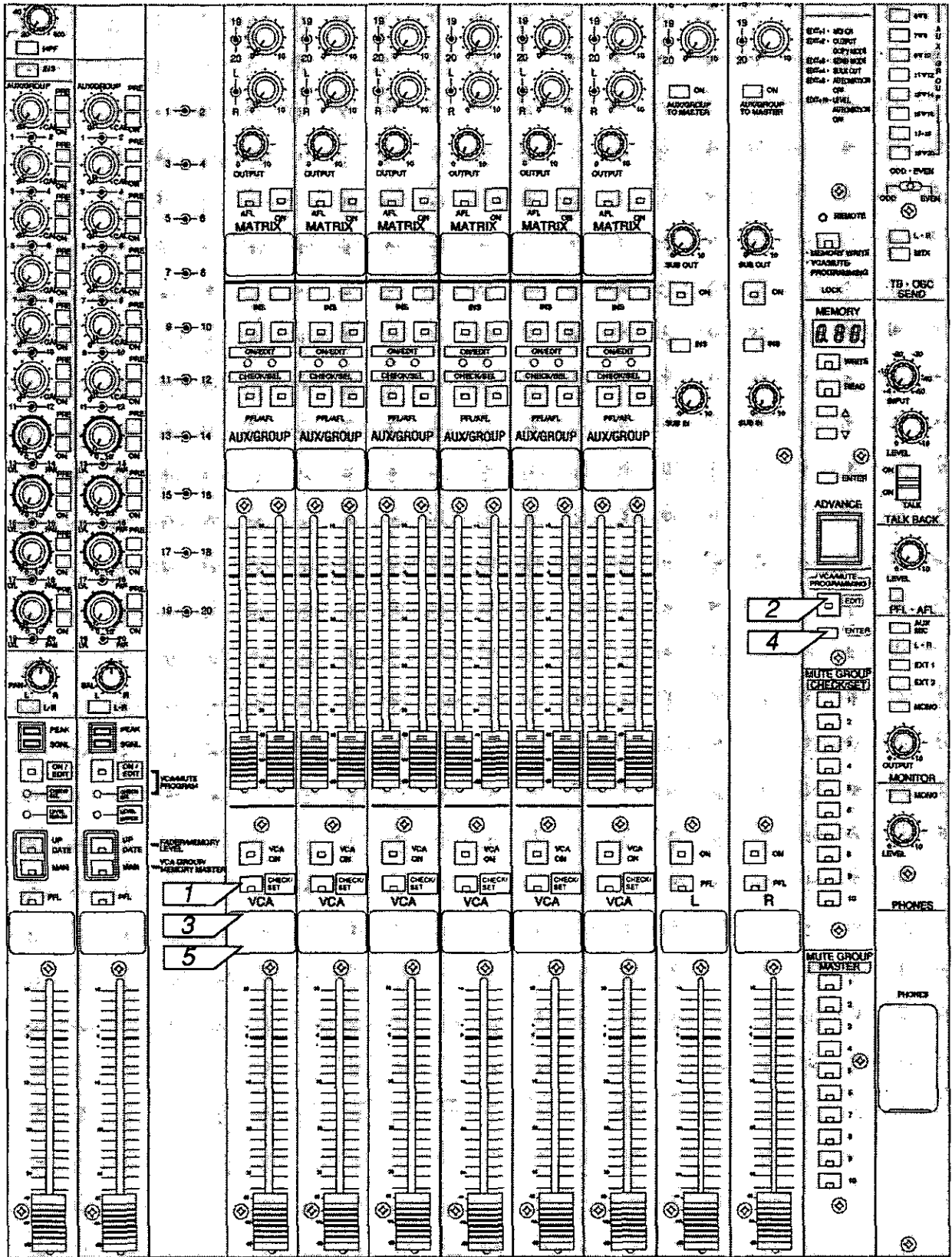

Note

- Batch-mode setting is not allowed. Make setting one by one as instructed in the above procedure.
- In Step 2, the ON/EDIT switch for each input module and AUX 1-20 is prohibited from channel ON/OFF setting and, instead, functions as a data input switch. However, since VCA-group modification is assumed in that status, pressing the AUX-1-20 ON/EDIT switch makes no change in status of the CHECK/SEL indicator.



CPU Control Functions

●Deleting preset data

-
- 1**  **Press** The EDIT-switch indicator blinks
-
- 2**  **Press** Press the CHECK/SET switch for the deletion-target number. The indicator on the pressed switch blinks
-
- 3**  **Press** This deletes VCA data, and completes setting
-
- 4**  **Press** Press the CHECK/SET switch for the VCA group number deleted. confirm that no CHECK/SEL indicator lights. To finished confirmation, press the CHECK/SET switch again
-

Note

- Batch-mode setting is not allowed. Make setting one by one as instructed in the above procedure.

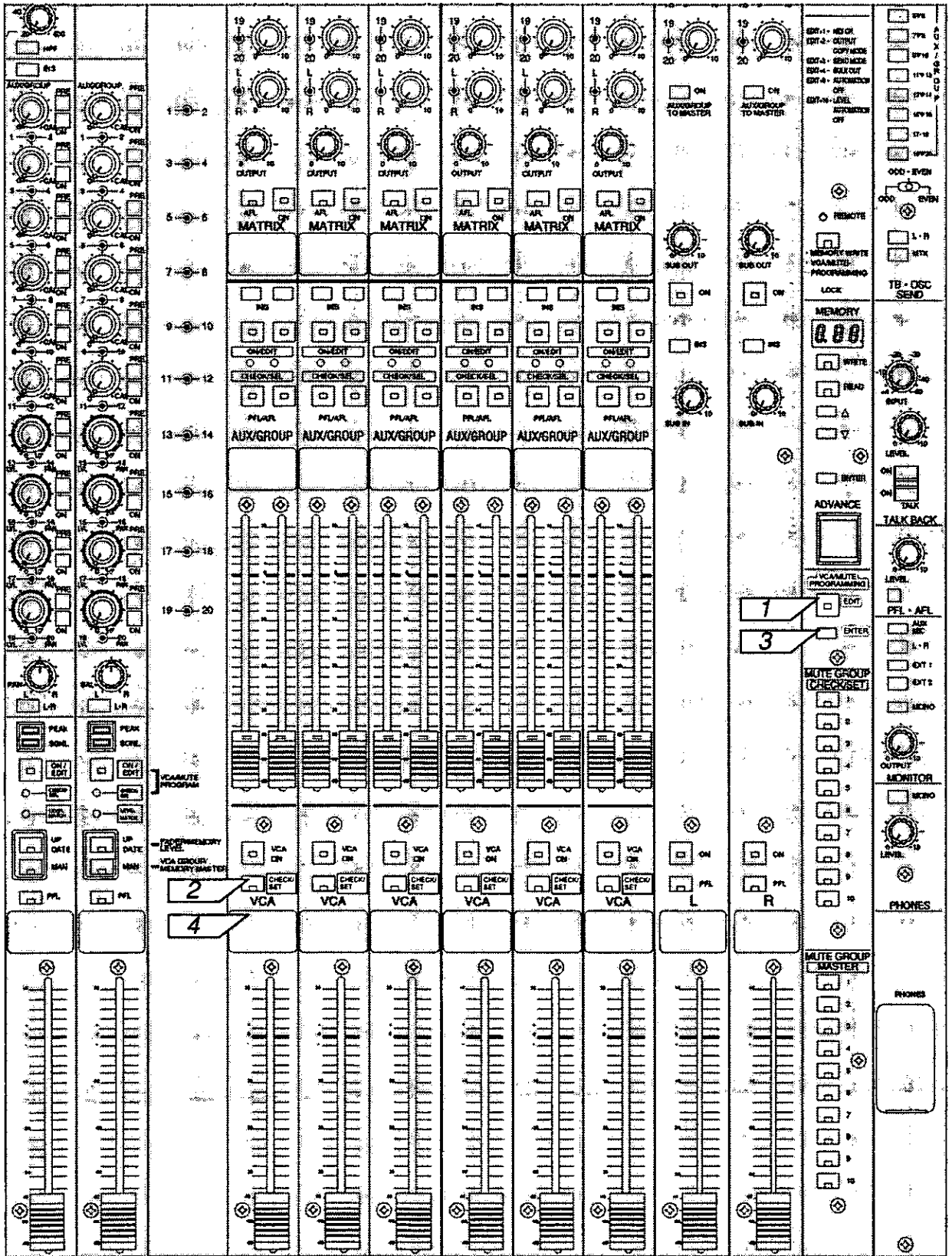

CPU Control Functions

■ 10-MUTE group function

The MUTE pattern for each channel is stored by making it correspond to 10 MUTE GROUP MASTER switches available in the memory master unit.

● MUTE group setting

- 1**

VCA/MUTE PROGRAMMING
 EDIT
Press

The EDIT-switch indicator blinks. The ON/EDIT switch for each input module and AUX 1~20 is prohibited from channel setting, and functions as a data input switch.

- 2**

MUTE GROUP CHECK/SET
 1~10
Press

Press the CHECK/SET switch for the setting-target MUTE-group number. The indicator on the pressed switch blinks. This status is called the "MUTE Edit Status."

- 3**

 ON/EDIT
Press

This sets a MUTE group. The ON-channel input module CHECK/SEL indicator blinks. The CHECK/SEL indicator for the channel to be muted remains off. Every press of the ON/EDIT switch alternates the blinking and going-off status of the CHECK/SEL indicator.

- 4**

 ENTER
Press

This registers MUTE-group data, and completes setting.

- 5**

MUTE GROUP CHECK/SET
 1~10
Press

Press the CHECK/SET switch for the MUTE-group number set. The indicator on that switch lights, and the CHECK/SEL indicator lights on those muted input modules and AUX/GROUP. To finished confirmation, press the CHECK/SET switch again.



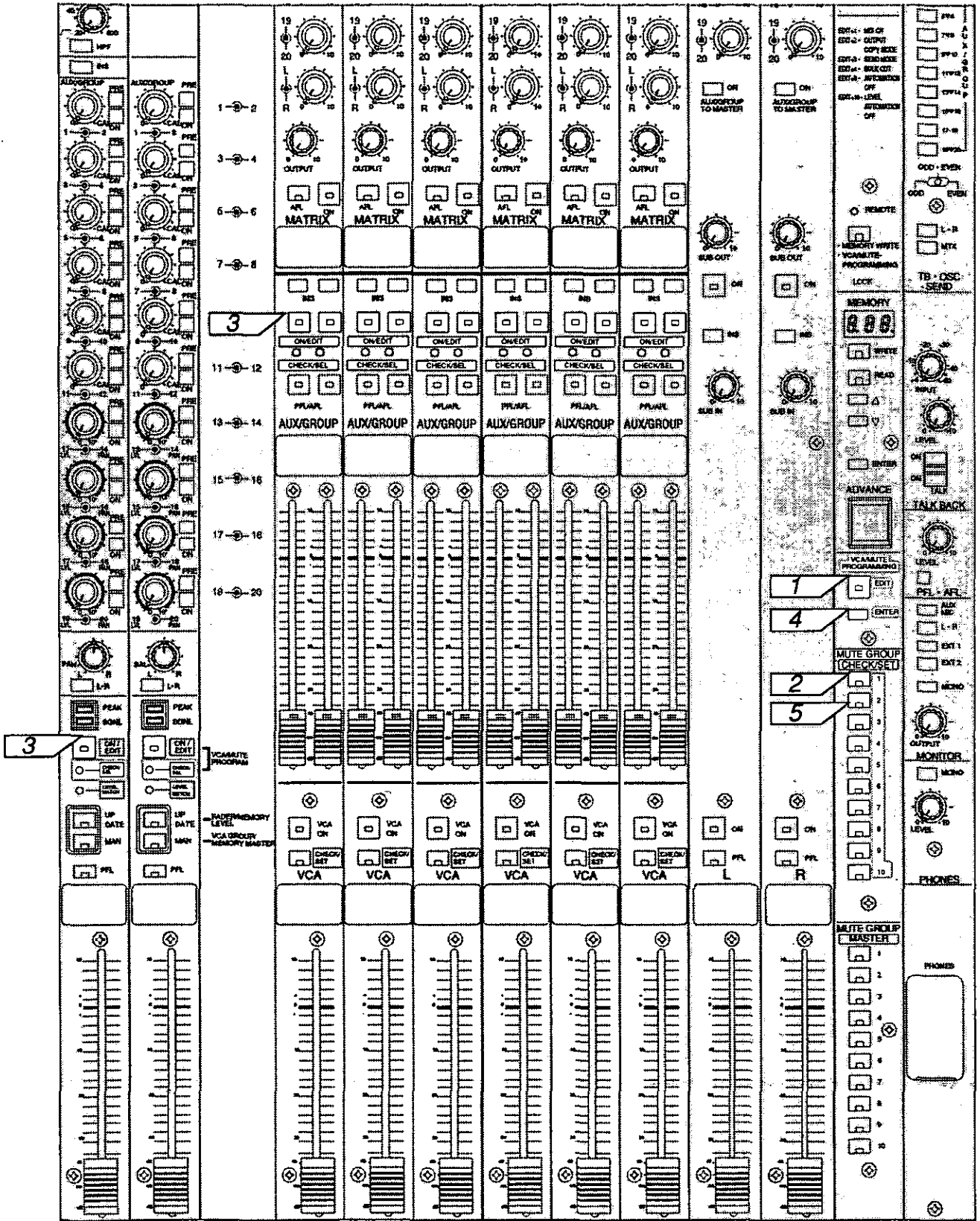

Note

- Operation Steps 2 and 3 can be in the reversed order.
- Batch-mode setting is not allowed. Make setting one by one as instructed in the above procedure.
- During the MUTE Edit Status, pressing a switch other than the CHECK/SET, VCA/MUTE PROGRAMMING ENTER, and ON/EDIT switches resets this status. Then the operation determined by the pressed switch is performed.



CPU Control Functions

●Modifying preset data

1	<p>MUTE GROUP CHECK/SET  1~10 Press</p>	<p>Press the CHECK/SET switch for the modification-target number. The indicator on the pressed switch lights, as well as the CHECK/SEL indicator for those input modules not muted in the corresponding MUTE group and for those of AUX 1~20 not muted. The CHECK/SEL indicator goes off for those input modules and AUX 1~20 to be muted.</p>
2	<p>VCA/MUTE PROGRAMMING  EDIT Press</p>	<p>The EDIT-switch indicator blinks. The lighting CHECK/SET-switch indicator and input-module CHECK/SEL indicator turn to blinking.</p>
3	<p> ON / EDIT Press</p>	<p>This provides MUTE-group modification. The CHECK/SEL indicator for input modules not to be muted blinks, and that indicator for input modules to be muted goes off. Every press of the ON/EDIT switch alternates the blinking and going-off status of the CHECK/SEL indicator.</p>
4	<p> ENTER Press</p>	<p>This modifies and registers MUTE group data, and completes setting.</p>
5	<p>MUTE GROUP CHECK/SET  1~10 Press</p>	<p>Press the CHECK/SET switch for the MUTE-group number modified. The indicator on that switch lights, and the CHECK/SEL indicator lights on those muted input modules and AUX/GROUP. To finished confirmation, press the CHECK/SET switch again.</p>



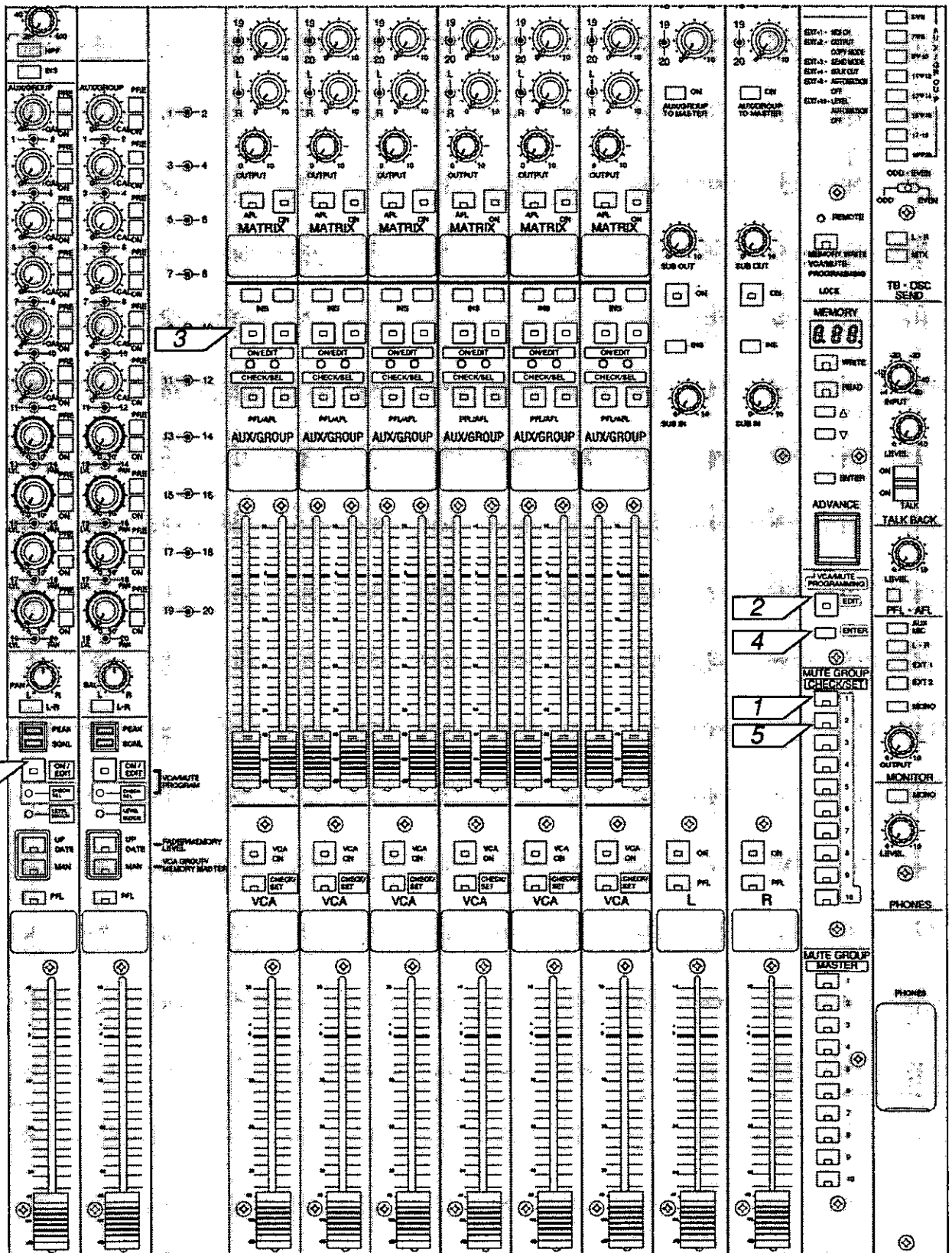

Note

- Batch-mode setting is not allowed. Make setting one by one as instructed in the above procedure.
- In Step 2, the ON/EDIT switch for each input module and AUX 1~20 is prohibited from channel ON/OFF setting, and functions as a data input switch.



CPU Control Functions

●Copying preset data

1	<p>MUTE GROUP CHECK/SET  1~10 Press</p>	<p>Press the CHECK/SET switch for the copying-target number. The indicator on the pressed switch lights, as well as the CHECK/SEL indicator for the input modules and AUX 1~20 not to be muted in the corresponding MUTE group. The CHECK/SEL indicator goes off for those input modules and AUX 1~20 to be muted.</p>
2	<p>VCA/MUTE PROGRAMMING  EDIT Press</p>	<p>The EDIT-switch indicator blinks. The lighting CHECK/SET-switch indicator and input-module CHECK/SEL indicator turn to blinking.</p>
3	<p>MUTE GROUP CHECK/SET  1~10 Press</p>	<p>Press the CHECK/SET switch for the copying-destination number. The indicator on the pressed switch blinks. The CHECK/SEL indicator status remains unchanged. To modify data in copying, press the ON/EDIT switch while in this status.</p>
4	<p> ENTER Press</p>	<p>This copies MUTE-group data, and completes setting.</p>
5	<p>MUTE GROUP CHECK/SET  1~10 Press</p>	<p>Press the CHECK/SET switch for the copying destination number. The indicator on that switch lights, and the CHECK/SEL indicator lights on those muted input modules and AUX/GROUP. To finished confirmation, press the CHECK/SET switch again.</p>

Note

- Batch-mode setting is not allowed. Make setting one by one as instructed in the above procedure.
- In Step 2, the ON/EDIT switch for each input module and AUX 1~20 is prohibited from channel ON/OFF setting and, instead, functions as a data input switch.

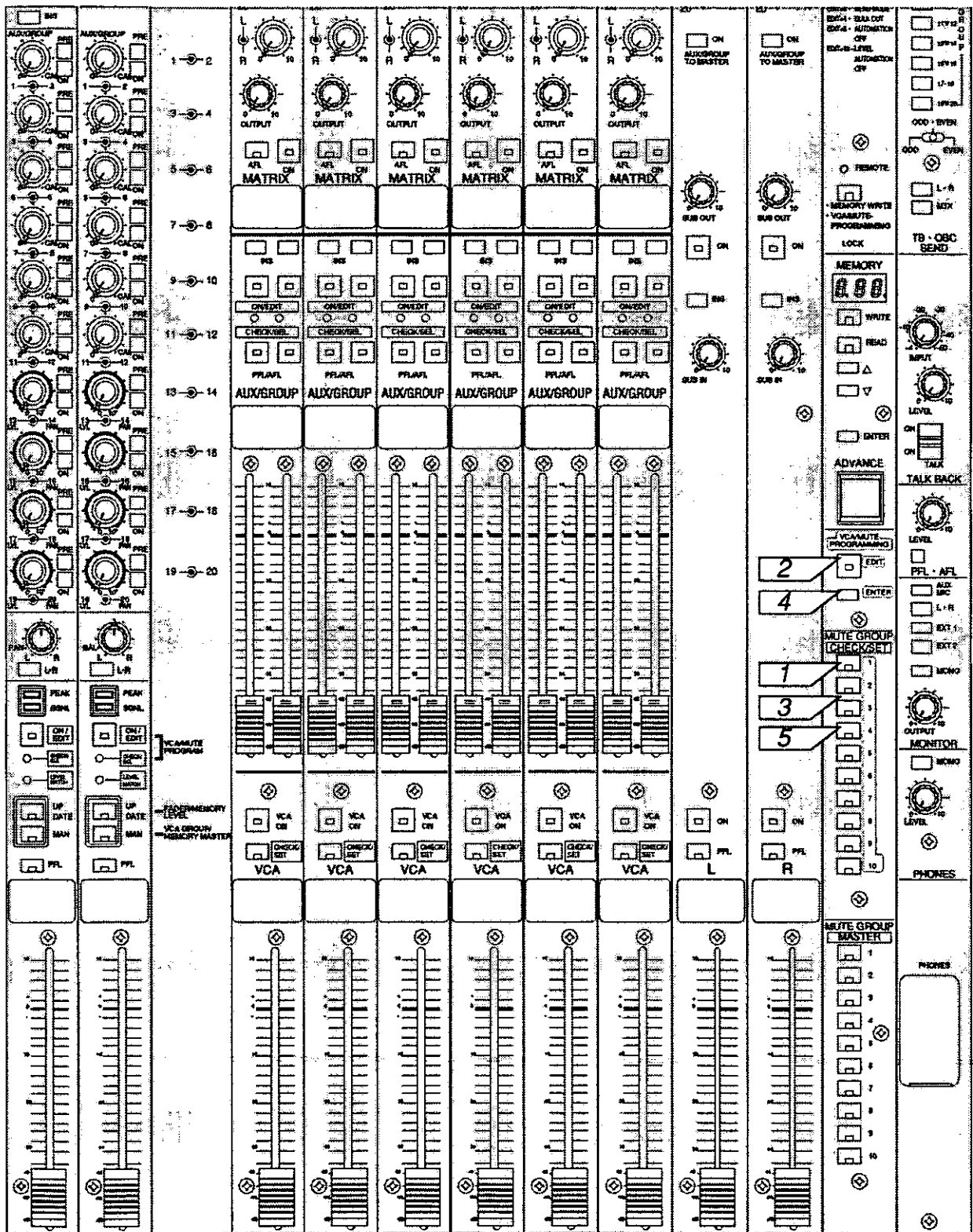

CPU Control Functions

●Deleting preset data

1  The EDIT-switch indicator blinks.
Press

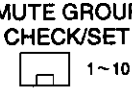
2  Press the CHECK/SET switch for the deletion-target number. The indicator on the pressed switch blinks.
Press

3  This deletes MUTE data, and completes setting.
Press

4  Press the CHECK/SET switch for the Mute-group number deleted.
Confirm that no CHECK/SEL indicator lights on the input modules and AUX/GROUP.
To finished confirmation, press the CHECK/SET switch again.
Press

Note

- Batch-mode setting is not allowed. Make setting one by one as instructed in the above procedure.

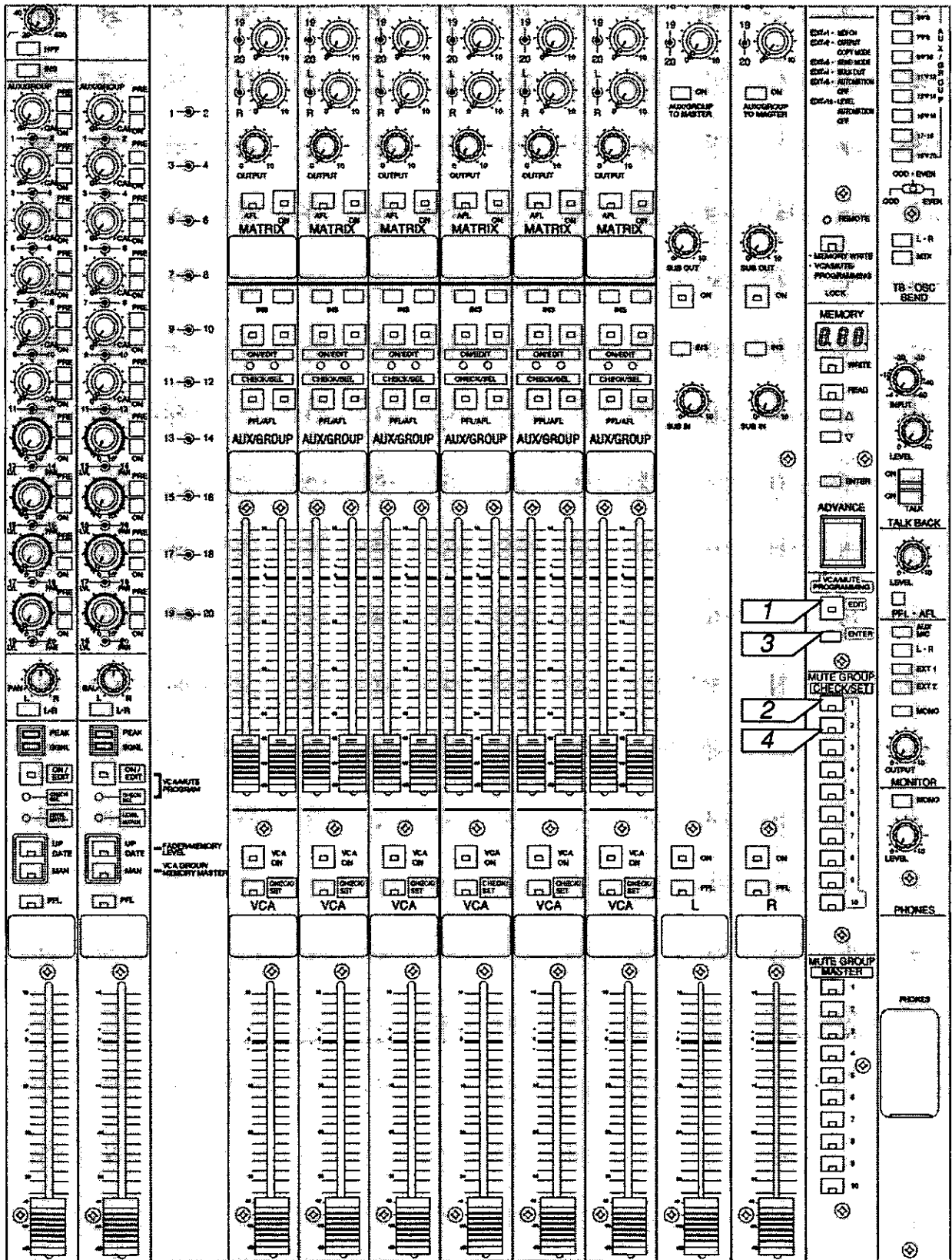

CPU Control Functions

●Executing MUTE group functions

1

MUTE GROUP
MASTER

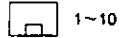

Press

Press the MASTER switch for the execution-target MUTE group number. The indicator on the pressed switch lights, and execution is started.

2

MUTE GROUP
MASTER



Press

To reset the status, press the MASTER switch for the resetting-target MUTE group number. The indicator on the pressed switch goes off, and the status is reset.

Note

- Execution of the MUTE group function allows selection of multiple targets. In this case, the MUTE status results from adding the preset data for the selected MUTE group. Manual operation is always valid.
- When one MUTE group is reset while multiple MUTE groups are being subjected to execution, the MUTE status reflects the remaining MUTE groups being subjected to execution and the manual operation performed after execution of those MUTE groups.

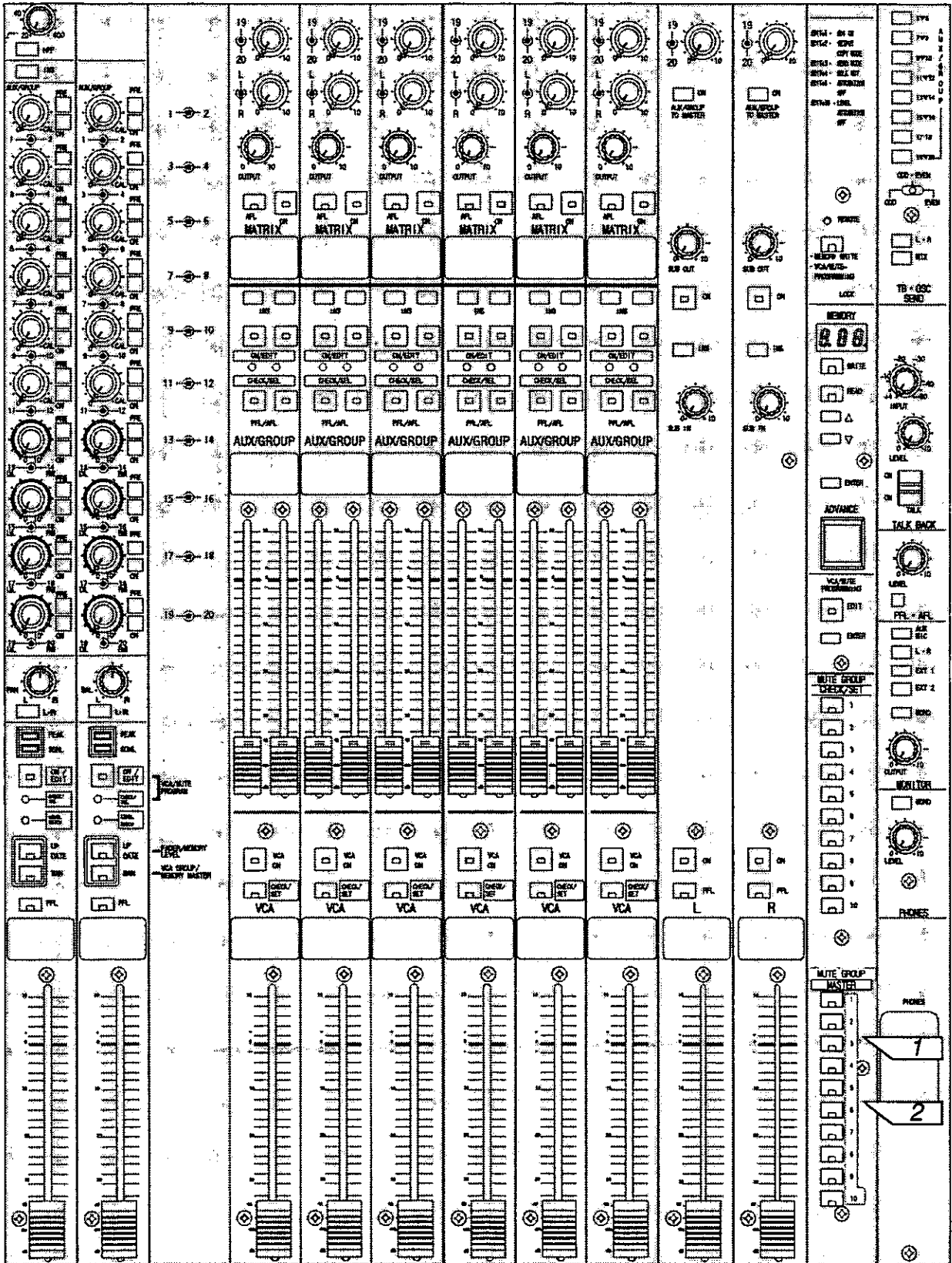

CPU Control Functions

■ 128-Pattern memory function

The status of this unit is stored (memorized) up to a maximum of 128 patterns. The data that can be memorized is as follows.

- Input fader level
- Input and AUX channel-ON/OFF status
- VCA assignment data
- MUTE group data
- Number of MUTE group under execution

● Write into memory

1

Set the status of this unit to allow a write into memory.

2



The WRITE-switch indicator blinks, as well as the memory number. This status is called the "Memory Write Status."

3

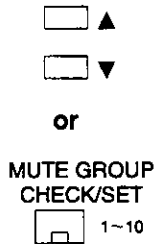

Set the write-target memory number. There are two ways for this setting as follows.

- ① Use of UP/DOWN switch [▲, ▼]
Pressing the switch shifts the memory number in forward or backward advancing. Continuing to press it provides high-speed shifting.
- ② Use of MUTE GROUP CHECK/SET switch [1~10]
Switches 1~10 are used as a numeric key. To set the memory number to 128, press switches 1, 2, and 8 in this given order.

4



This registers data, and completes writing into memory. The WRITE -switch indicator goes off, and the set number is displayed.

Note

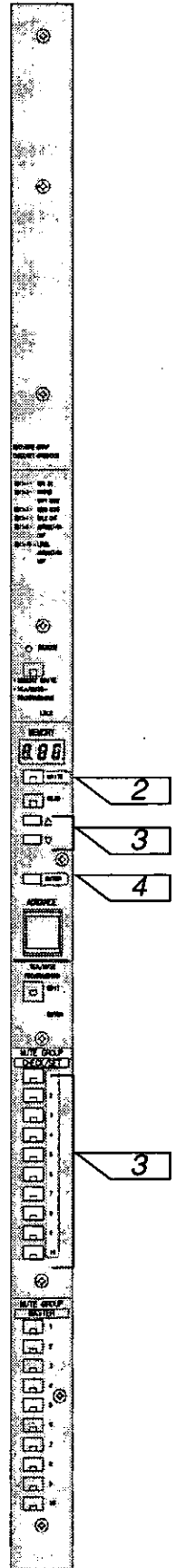

- The memory write status is reset by pressing a switch other than the UP/DOWN, MUTE GROUP CHECK/SET, and MEMORY ENTER.
- When setting the memory number with the UP/DOWN switches, pressing the DOWN switch when the memory number is at 1 turns the number to 128. On the other hand, when the number is at 128, pressing the UP switch turns the number to 1.
- When the write is completed, a dot lights at the right foot of the memory number. This dot goes off when manual operation makes the status inconsistent with the data written in the memory.



●Read from memory

1  READ
Press

The READ-switch indicator blinks, as well as the memory number. This status is called the "Memory Read Status".

2  ▲
 ▼
or
MUTE GROUP CHECK/SET
 1~10

Set the read-target memory number. There are two ways for this setting as follows.

① Use of UP/DOWN switch [▲, ▼]

Pressing the switch shifts the memory number in forward or backward advancing. Continuing to press it provides high-speed shifting.

② Use of MUTE GROUP CHECK/SET switch [1~10]Switches

Switches 1~10 are used as a ten-key pad. To set the memory number to 128, press switches 1, 2, and 8 in this given order.

3  ENTER
Press

This completes the read from memory, executing registered data. The READ-switch indicator goes off, and the set memory number is displayed (blinking is terminated).

Note

- The memory read status is reset by pressing a switch other than the UP/DOWN, CHECK/SET, and MEMORY ENTER.
- When setting the memory number with the UP/DOWN switches, pressing the DOWN switch when the memory number is at 1 turns the number to 128. On the other hand, when the number is at 128, pressing the UP switch turns the number to 1.
- When the read is completed, a dot lights at the right foot of the memory number. This dot goes off when manual operation makes the status inconsistent with the data read from the memory.

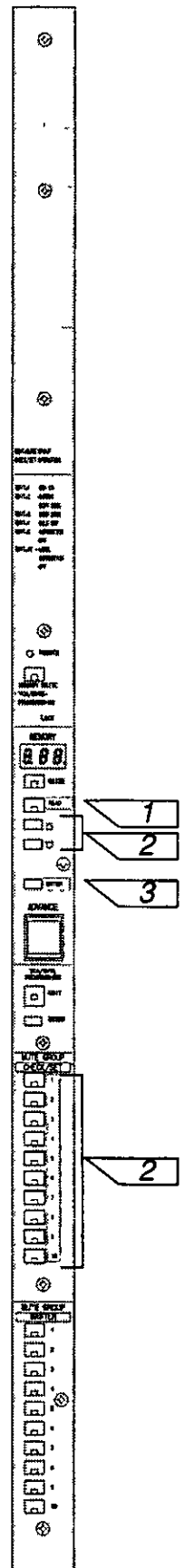

CPU Control Functions

■ Executing ADVANCE

The status of this unit is stored (memorized) up to a maximum of 128 patterns. The data that can be memorized is as follows.

1

ADVANCE

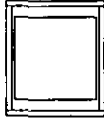

Press

Read is made from the memory number next to the memory number being displayed, and then registered data is subjected to execution. Subsequently, press the ADVANCE switch according to the scene.

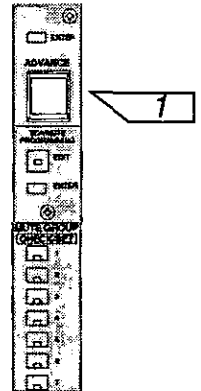

Note
The ADVANCE switch normally lights weakly. However, it lights brightly for the time interval from the beginning of ADVANCE execution to the completion.

■ Check program functions

This unit is fitted with the program to check status. The detailed check-program functions and the procedure for activating them are as follows.

CHK/SET	Item to be checked	Description
1	SW check	When the ON/EDIT switch on modules is pressed, channel numbers for the switch-pressed modules are displayed on the memory number display area.
2	LED check 1	The CHECK/SEL indicators are sequentially lit at 0.5-sec intervals on modules starting with input 1.
3	LED check 2	The CHECK/SEL indicators are sequentially lit at a high speed on modules starting with input 1.
5	VCA check	The fader value (MIDI transmission code, see page 62) for the channel having the ON/EDIT switch pressed is displayed on the memory number display area. The display is continued until another ON/EDIT is pressed. The selected fader operation is reflected in display. When the MIDI SEND mode is set to "Exclusive," all steps are displayed. For CTRL, the corresponding value is displayed only when a change over 2 ranks is generated.

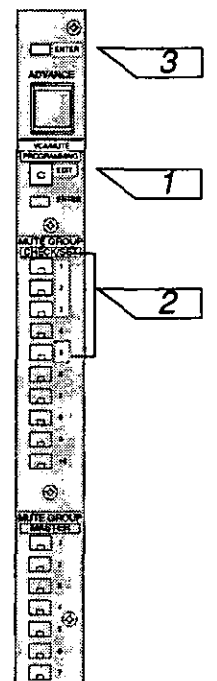

1

VCA/MUTE PROGRAMMING



Press

While pressing the EDIT switch, turn the power supply on. "TST" is displayed on the memory number display area, and the check program is activated.

2

MUTE GROUP CHECK/SET



Press

Pressing CHECK/SET switches 1, 2, 3, and 5 provides the checks described in the above table.

3

ENTER



Press

The check program is terminated

Setting level automation

CPU control of input level setting is set to ON or OFF. The setting is to ON during shipment from the factory.

1

VCA/MUTE PROGRAMMING EDIT → MUTE GROUP CHECK/SET 10

While holding down → Press

Level automation is set to OFF, and a dot lights under the memory number display. In this status, it is invalid the automation control by the CPU of each input module. The LED lights for level match.

2

VCA/MUTE PROGRAMMING EDIT → MUTE GROUP CHECK/SET 10

While holding down → Press

To return the setting to ON, perform the operation in Step 1 again. The dot under the memory number display goes off.

Note

- The dot to light under the memory number display is displayed as follows.



- The relationship between level automation and operation-mode setting switch 6 is as follows.

	Switch 6 ON	Switch 6 OFF
Level automation ON	Input fader : Valid VCA group : Valid Automation data from CPU : Valid UP DATE indicator : *1 Level control is provided with the fader and VCA group. When the UP DATE switch is pressed, automation data from CPU is added to the above.	Input fader : *1 VCA group : Valid Automation data from CPU : Valid UP DATE indicator : *1 Level control is provided with automation data from CPU and the VCA group. Pressing the UP DATE switch adds the fader level to the above.
Level automation OFF	Input fader : Valid VCA group : Valid Automation data from CPU : Invalid UP DATE indicator : *2 Level control is provided with the fader and VCA group. Even when the UP DATE switch is pressed, automation data from CPU is not added to the above.	Input fader : Valid VCA group : Valid Automation data from CPU : Invalid UP DATE indicator : *3 Level control is provided with the fader and VCA group.

*1: Depends upon the pressed status of UP DATE switch.

*2: When the UP DATE switch is pressed, the switch indicator does not light.

*3: When the UP DATE switch is not pressed, the switch indicator lights.

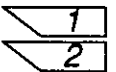
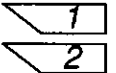
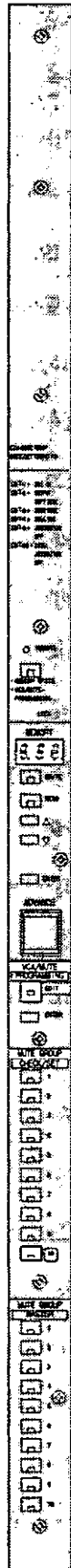

CPU Control Functions

■ Setting automation

Excluding MUTE group and VCA group setting, CPU control functions (memory read/write, ADVANCE execution, environment setting) are set to ON or OFF. The settings are to ON during shipment from the factory. When automation is set to OFF, level automation can be set to OFF. On the other hand, when level automation is set to OFF, the following operation allows setting automation to OFF.

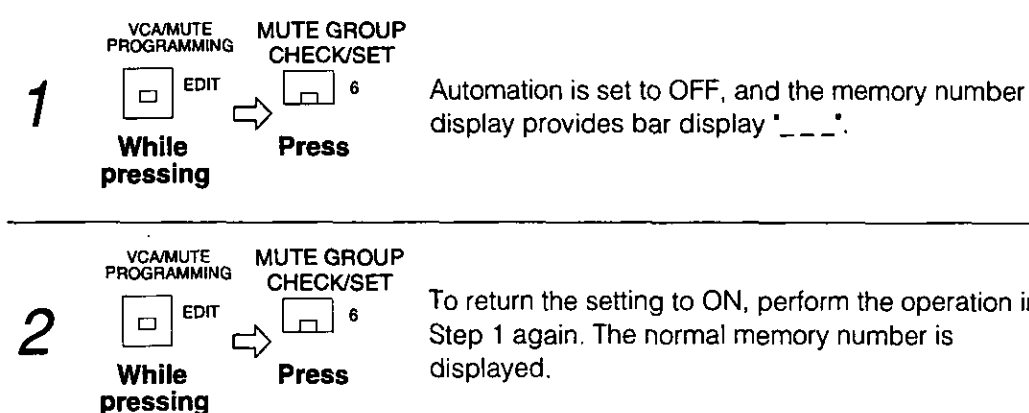

Note

- In the status of Step 1, this unit is under the following conditions.



Input-module level control:	CPU level invalid
	Fader and VCA group valid
LEVEL MATCH LED	Invalid (lights at +10dB)
MUTE group	Valid
VCA group	Valid
Memory read/write	Invalid
ADVANCE execution	Invalid
MIDI environment setting/bulk-out	Invalid

- The relationship between automation and operation-mode setting switch 6 is the same as that provided in Level Automation Descriptions (see page 49).

■ Initializing memory

All data stored in this unit is deleted, and the status is returned as set during shipment from the factory

1

 WRITE
 EDIT

**While holding down these,
turn power supply on.**

The memory number display area displays "Err" and "Clr" alternately

2

 ENTER

Press

Memory is deleted, and data is initialized to the status set during shipment from the factory

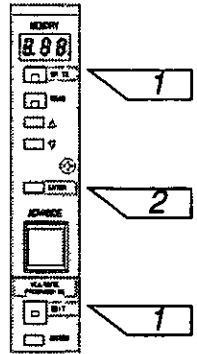

MIDI

The WR-SX1A is equipped with MIDI (Musical Instrument Digital Interface) and can exchange programs with the effector, sequencer, or other MIDI equipment. When two or more WR-SX1A mixers are connected to each other, they can copy parameters or memory contents between each other, as well as exchange programs with each other. Also the mixer can be remotely controlled from a personal computer through MIDI.

■ Setting MIDI

Press MUTE GROUP CHECK/SET switch 1 to 4 while holding down the VCA/MUTE PROGRAMMING EDIT Switch, and you will be able to set any of the following parameters depending on the CHECK/SET Switch number you operated.

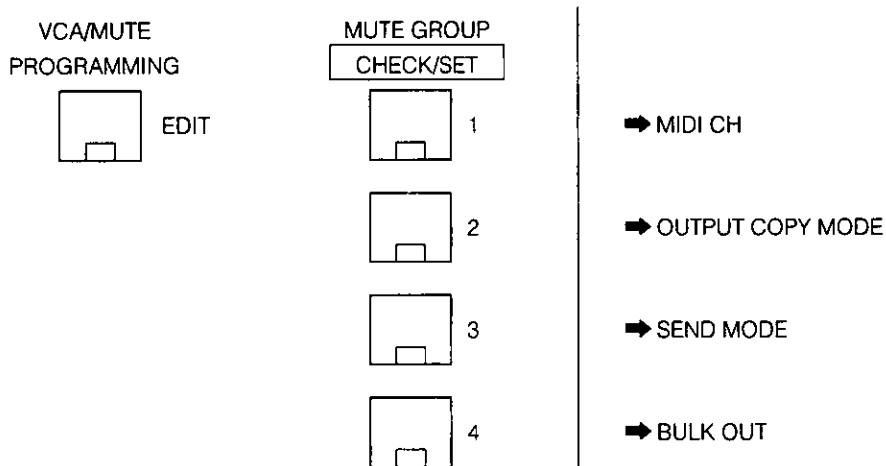

Switch No	Item	Parameter setting	Initial value	Item display	Example of parameter display
1	MIDI CH	OFF OMNI, 1-16	OMNI(o)	CH	OFF, 0, 1~16
2	OUTPUT COPY MODE	COPY OFF COPY ON	COPY OFF	CPY	On, OFF
3	SEND MODE	CTRL Exclusive OFF	Exclusive (FOH)	Snd	bnH, FOH, OFF
4	BULK OUT	CURRENT MEMORY	CURRENT (Cur)	blo	Cur, 128

● Setting MIDI Channel

Pressing switch 1 allows you to set MIDI channel. Data can be sent/received through MIDI only if the channel on the transmitter side matches that on the receiver side.

(1) Press MUTE GROUP CHECK/SET 1 Switch while holding down VCA/MUTE PROGRAMMING EDIT Switch.

The item to be set and parameter value will be displayed alternately.

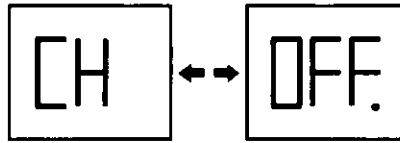

(2) Use the Memory Number Up/Down switches (▲, ▼) to select an appropriate parameter value.

Parameter value can be selected from "OFF", "OMNI(O)", and "1 to 16".

The default selection is "O" for "OMNI".

When OMNI is selected, reception channel is not identified and transmission channel is fixed to "1".

(3) Press VCA/MUTE PROGRAMMING ENTER or MEMORY ENTER switch. MIDI channel setting is now completed.

● Setting Output Copy Mode

Pressing switch 2 allows you to set output copy mode.

The initial value is set to "COPY ON". (Parameter value "ON" is on the display.)

(1) Press MUTE GROUP CHECK/SET 2 switch while holding down VCA/MUTE PROGRAMMING EDIT switch.

The item to be set and parameter value are displayed alternately.

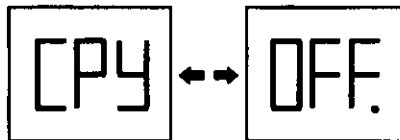

(2) Use the Memory Number Up/Down switches (▲, ▼) to select an appropriate parameter value.

Parameter value can be selected from "COPY ON (ON)" and "COPY OFF (OFF)".

The default selection is "OFF" for "COPY OFF".

(3) Press the VCA/MUTE PROGRAMMING ENTER or MEMORY ENTER switch.

Output copy mode setting is now completed.

● **Setting Send Mode**

Pressing switch 3 allows you to set the code format to be sent in Send mode.

(1) **Press MUTE GROUP CHECK/SET 3 switch while holding down VCA/MUTE PROGRAMMING EDIT Switch.**

The item to be set and parameter value are displayed alternately.

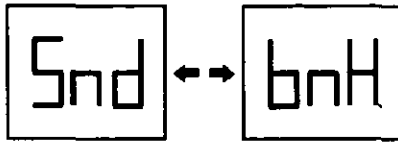

(2) **Use the Memory Number Up/Down switches (▲, ▼) to select an appropriate parameter value.**

Parameter value can be selected from "CTRL (BnH)", "Exclusive (FOH)", and "OFF".

The default selection is "FOH" for "Exclusive".

Parameter	Contents
BnH	Mute group execution information or LOCK execution information is sent with the Control Change command. CH ON/OFF status information is sent each time CH ON/OFF status changes. VCA value is sent if VCA value has changed by 0.4 dB or more from the final value. Memory number is sent with the Program Change command.
FOH	Mute group execution information is sent with RAMSA ONE-WAY exclusive message. Memory number is sent with the Program Change command. This mode is suited for interlocked dual operation for PA.
OFF	No execution information is sent. Control changes are not received.

(3) **Press the VCA/MUTE PROGRAMMING ENTER or MEMORY ENTER Switch.**

Send mode setting is now completed.

● **Executing Bulk Out**

Pressing switch 4 allows you to send the combination of currently set data (CURRENT) and memory contents (MEMORY).

(1) **Press MUTE GROUP CHECK/SET 4 Switch while holding down the VCA/MUTE PROGRAMMING EDIT Switch.**

The item to be set and parameter value are displayed alternately.

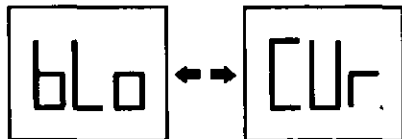

(2) **Use the Memory Number Up/Down switches (▲, ▼) to select an appropriate parameter value.**

Parameter value can be selected from "CURRENT(Cur)" and "MEMORY(128)".

The default selection is "Cur" for "CURRENT".

(3) **Press the MEMORY ENTER Switch.**

Bulk out setting is now completed and executed.

NOTE: The Transmitting time is due to the display of send mode as shown below.

[CTRL (BnH)] : approx. 1 minute in CURRENT
approx. 1 hour in MEMORY

[Exclusive (FOH)] : approx. 1 minute in CURRENT
approx. 10 minutes in MEMORY

When you want to cancel, press again the VCA/MUTE PROGRAMMING ENTER Switch.

■ Functions and Connections

● Concentrated Control 1 (Handshake)

- Up to sixteen WR-SX1 Mixers can be controlled from a PC using the handshake procedure
- A message from the PC is sent to the pertinent unit with the hard-through feature. On receiving the message, the unit returns a reply message to the PC.

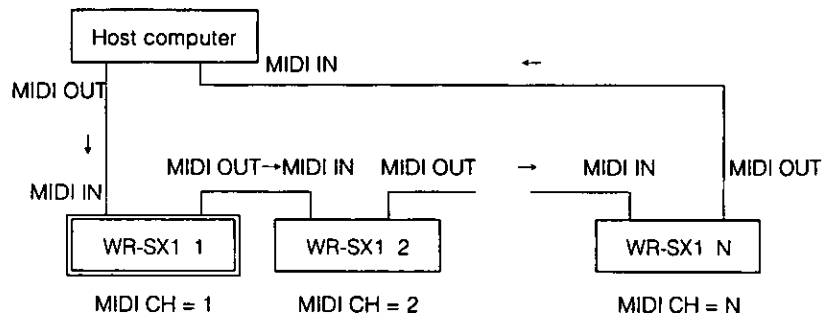

● Concentrated Control 2 (Handshake)

- Up to sixteen WR-SX1 Mixers can be controlled from a PC using the handshake procedure
- A message from the PC is sent to the pertinent unit with the hard-through feature. On receiving the message, the unit returns a reply message to the PC.

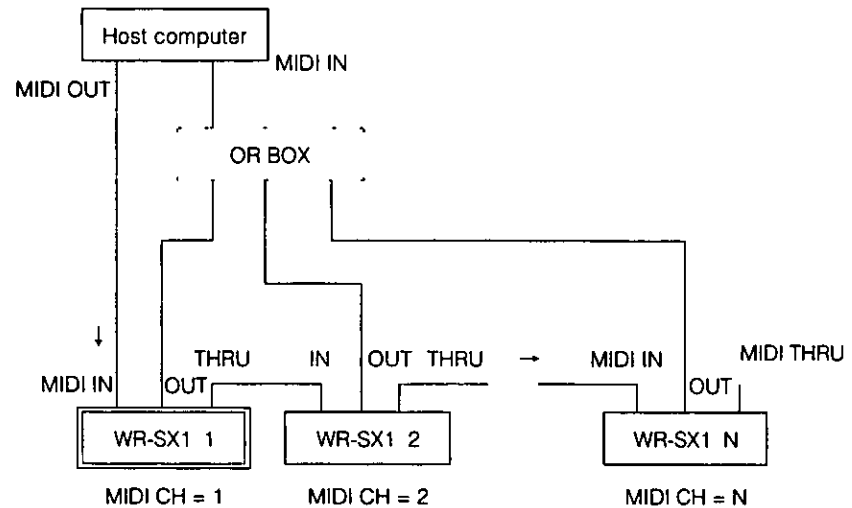

● Parallel Control (Three or more Mixers)

- Mixer A can control Mixers B and C
- As Mixer A sends a message to Mixers B and C, Mixers B and C perform operation according to the received message
- To use this feature, the following preparations are required
 - ① Set the same MIDI channel for Mixers A, B, and C. It is allowable to set the OMNI channel for all the three Mixers
 - ② Set Mixer A's send mode to CTRL or Exclusive

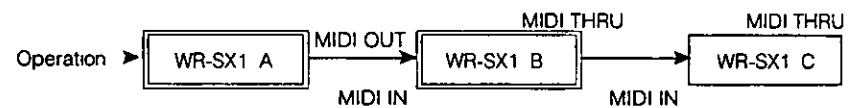

● **Data Copy**

- If bulk out is executed on the sender unit, the specified message is sent without regard to the MIDI send mode, and the receiver unit performs operation according to the received message.
- To use this feature, the same MIDI channel must be set on both the transmitter and receiver units. The OMNI channel may be set on both the transmitter and receiver units.

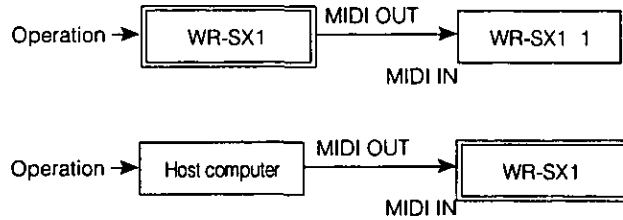

● **Connection to a MIDI Keyboard**

- A MIDI keyboard allows program changes.



● **Connection to a Sequencer**

(1)Control information recording on sequencer

① When MIDI send mode is CTRL:

The following information is recorded on the sequencer which can record control changes:

- Control change messages issued upon mute, lock execution or channel ON/OFF.
- Program change messages issued upon memory call.
- Control change messages to be used when bulk out is executed.

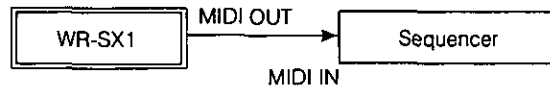

② When MIDI send mode is Exclusive:

The following information is recorded on the sequencer which can record control changes:

- Exclusive messages issued upon mute, execution.
- Program change messages issued upon memory call.
- Exclusive messages to be used when bulk out is executed.

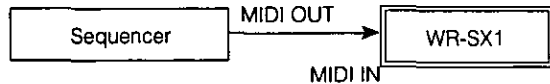

(2)Control from sequencer

The information recorded on the sequencer is reproduced.

● **Connections to be Avoided**

To prevent lowered operability, avoid the following connections:

- ① Cross connection

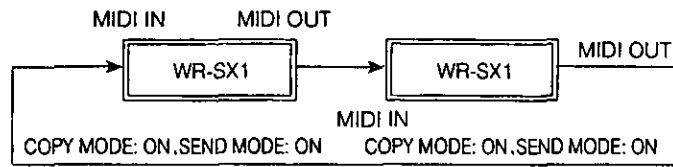

- ② Unusual connections

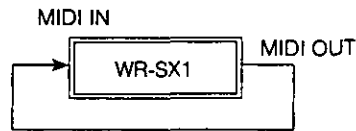

MIDI Data Format

The following tables show the MIDI functions Refer to the following tables for making the PC program

■ Outline of MIDI Messages

● MIDI Voice Messages

MIDI status	Nomenclature	Original MIDI function	Function on this system
8nH, kk, vv	NOTE OFF	Stops the note	Not used
9nH, kk, vv	NOTE ON	Activates the note Velocity 0 corresponds to NOTE OFF	Not used
AnH, kk, vv	Polyphonic Key Pressure	Transfers key polyphonic key pressure (after touch)	Not used
BnH, cc, vv	Control Change	Control for other than keyboard This system uses NRPN	Transmission When MIDI=ON and SEND MODE=CTRL or upon mute execution or BULK OUT Reception MIDI=ON reception processing is performed
CnH, pp	Program Change	Tone switching	Transmission When memory read is per- formed during MIDI=ON Reception Reception processing is always performed as far as MIDI=ON
DnH, vv	Channel Pressure	Overall after touch	Not used
EnH, vv, vv	Pitch Bend	Pitch bend information	Not used

Note n MIDI channel (0H-FH)
 kk Note (key) number (0-127 (00H-7FH))
 vv Key velocity (0-127 (00H-7FH))
 pp Program number (0-127 (00H-7FH))
 * Each requires to clear the running status buffer

● RAMSA Exclusive Messages

Message	Processing	
	Reception processing	Transmission processing
Handshake message	<ul style="list-style-type: none"> Performed whenever MIDI=ON System's all setup values, including those in this memory, can be set 	<ul style="list-style-type: none"> Transmission processing according to reception message This system does not perform transmission processing on its own accord
Non-procedure in handshake message	<ul style="list-style-type: none"> Performed whenever MIDI=ON Memory read is performed 	<ul style="list-style-type: none"> No function setting
One-way message	<ul style="list-style-type: none"> Performed whenever MIDI=ON System's all setup values, including those in this memory, can be set 	<ul style="list-style-type: none"> This message is sent when SEND MODE=Exclusive or muting is executed Transmitted when SEND MODE=Exclusive or bulk out is set

* Each requires to clear the running status buffer

■ MIDI Voice Messages

● Program Change Feature

- By accepting a program number, the READ operation for specified program activates according to the program table specified within the system
- If read operation is performed during link operation, the following message is issued
- For the continuous transmission, 130 m sec or more interval should be required

Cn	H	PGM	No.
----	---	-----	-----

● Control Change Feature

(1) Control with NRPN

① Registering MSB of NRPN

BnH,	63H,	PmH
------	------	-----

- * n H,63H,pmH n Indicate MIDI channel
- * Pm MSB of parameter number (0-127, 0H-7FH)
- When this code is received, the MSB of parameter number becomes active, in which the system is ready for data entry
- This code is chiefly used for screen selection The screen that corresponds to pm is displayed

② Registering LSB of NRPN

Bn H,	62H,	PIH
-------	------	-----

- * n Shows MIDI channel
- * PI LSB of parameter number (0-127, 0H-7FH)
- When this code is received, the LSB of parameter number activates, in which the system is in the data entry state
- This code has the same meaning as cursor selection The parameter that corresponds to p1 is selected and activated

③ Data entry of parameter selected with NRPN MSB

Bn H,	06H,	dmH
-------	------	-----

- * n Shows MIDI channel
- * dm MSB of parameter number (0-127, 0H-7FH)
- When this code is received, a value is set into the active parameter

④ Data entry of parameter selected with NRPN LSB

Bn H,	26H,	dIH
-------	------	-----

- * n Shows MIDI channel
- * dI LSB of parameter number (0-127, 0H-7FH)
- When this code is received, a value is set into the active parameter

■ Parameter Table for Control Change

(1) Parameter number MSB table

BnH, 63H, pm		
MSB(pm)of parameter No.	Function	
Outside the specified numbers	No function setting. While parameter number is updated, data entry is ignored if data is subsequently received.	
20H-2AH	Mute group data setting	Input CH data: 21H-54H (33-84) AUX CH data: 55H-68H (85-104)
2BH	Current setting	Input CH data: 21H-54H (33-84) AUX CH data: 55H-68H (85-104) Mute group execution selection: 69H-72H (105-114)
31H-3AH	VCA group setting	Input: 21H-54H (33-84)
40H	VCA value setting	Input: 21H-54H (33-84)
50H	Memory selection status	0 to 127
51H	Memory non-selection status	No LSB data
60H	ADVANCE execution	No LSB data

* Mute group setting (20H-2AH) corresponds to mute group 0 (all Mute group un-selecting state) and mute groups 1-10, respectively.

* VCA group setting (31H-3AH) corresponds to VCA groups 1-10, respectively.

* ADVANCE is executed when BnH, 63H, or 60H is received.

(2) Parameter number LSB table

● Parameter (LSB) table for MUTE group setting

Mute group setting parameter (LSB) table			
(BnH, 63H, 20-2BH)		BnH, 62H, PI	
LSB (pi) of parameter No.	Function and value		
	Parameter name	Setting range	Data range
33-84 21H-54H	CH	ON/OFF	dm=00-3FH:OFF, dm=40-7FH:ON
85-104 55H-68H	CH (AUX)	ON/OFF	dm=00-3FH:OFF, dm=40-7FH:ON
105-114 69H-72H	Mute group execution	ON/OFF	dm=00-3FH:OFF, dm=40-7FH:ON

* The LSB of parameter number shows set up channel.

* The LSB of data is not specified.

* LSB=105-114 (69H-72H) is valid only for the current setting (MSB=2BH).

* The current is changed when memory is not selected.

②Parameter (LSB) table for VCA group setting

VCA group setting parameter (LSB) table			
(BnH, 63H, 31-3AH)		BnH, 62H, PI	
LSB (PI) of parameter No.	Function and value		
	Parameter name	Setting range	Data range
33-84 21H-54H	VCA-GRP	ON/OFF	dm=00-3FH:OFF, dm=40-7FH:ON

- * The LSB of parameter number indicates set up channel.
- * The current is changed when memory is not selected.

③Parameter (LSB) table for VCA channel setting

VCA current setting parameter (LSB) table			
(BnH, 63H, 40H)		BnH, 62H, PI	
LSB (PI) of parameter No.	Function and value		
	Parameter name	Setting range	Data range
33-80 21H-50H	VCA-CH (MONO)	+10 – -80dB, OFF	See LVL data table.
81-84 51H-54H	VCA-CH (STR)		

- * The LSB of parameter number indicates the channel that was set.

④Memory selection status

Bn H, 63H, 50H

Bn H, 62H, mmH

The above is received. After the parameter is defined, a memory number, 1 to 128, which corresponds to selected memory number "mm" is activated, so that the data can be stored in the corresponding memory.

Bn H, 63H, 51H

When the above is received, the memory selection status is canceled by defining the parameter.

⑤ADVANCE execution status

Bn H, 63H, 51H

When the above is received, ADVANCE is executed.

Note

After reception of data, the control changing function requires processing timeup to execution. Therefore, any continuous transmission must be made at the intervals of more than 10, 20, or 60msec, depending upon types of data.

● Channel Information Sequential Send Feature

If any change occurs in the following information when MIDI=ON and MIDI send mode=CTRL, the changes are sequentially transmitted.

- Input channel ON/OFF
- Input VCA value ... When the rank indicated in the AD level table has changed by 2 or more ranks.

The following table shows the AD level. (See page 54)

dB value	dB range			Range LSB			Span	Range HEX			Transmission code			
	MAX		MIN	MAX		MIN		MAX		MIN	MSB	HEX	LSB	HEX
10.0	9.90	-	*****	2	-	0	3	2	-	0	127	7F	8	08
9.8	9.70	-	9.89	6	-	3	4	6	-	3	126	7E	11	0B
9.6	9.50	-	9.69	10	-	7	4	A	-	7	126	7E	9	09
9.4	9.30	-	9.49	14	-	11	4	E	-	B	125	7D	12	0C
9.2	9.10	-	9.29	18	-	15	4	12	-	F	125	7D	10	0A
9.0	8.90	-	9.09	22	-	19	4	16	-	13	125	7D	8	08
8.8	8.70	-	8.89	26	-	23	4	1A	-	17	124	7C	11	0B
8.6	8.50	-	8.69	30	-	27	4	1E	-	1B	124	7C	9	09
8.4	8.30	-	8.49	34	-	31	4	22	-	1F	123	7B	12	0C
8.2	8.10	-	8.29	38	-	35	4	26	-	23	123	7B	10	0A
8.0	7.90	-	8.09	42	-	39	4	2A	-	27	123	7B	8	08
7.8	7.70	-	7.89	46	-	43	4	2E	-	2B	122	7A	11	0B
7.6	7.50	-	7.69	50	-	47	4	32	-	2F	122	7A	9	09
7.4	7.30	-	7.49	54	-	51	4	36	-	33	121	79	12	0C
7.2	7.10	-	7.29	58	-	55	4	3A	-	37	121	79	10	0A
7.0	6.90	-	7.09	62	-	59	4	3E	-	3B	121	79	8	08
6.8	6.70	-	6.89	66	-	63	4	42	-	3F	120	78	11	0B
6.6	6.50	-	6.69	70	-	67	4	46	-	43	120	78	9	09
6.4	6.30	-	6.49	74	-	71	4	4A	-	47	119	77	12	0C
6.2	6.10	-	6.29	78	-	75	4	4E	-	4B	119	77	10	0A
6.0	5.90	-	6.09	82	-	79	4	52	-	4F	119	77	8	08
5.8	5.70	-	5.89	86	-	83	4	56	-	53	118	76	11	0B
5.6	5.50	-	5.69	90	-	87	4	5A	-	57	118	76	9	09
5.4	5.30	-	5.49	94	-	91	4	5E	-	5B	117	75	12	0C
5.2	5.10	-	5.29	98	-	95	4	62	-	5F	117	75	10	0A
5.0	4.90	-	5.09	102	-	99	4	66	-	63	117	75	8	08
4.8	4.70	-	4.89	106	-	103	4	6A	-	67	116	74	11	0B
4.6	4.50	-	4.69	110	-	107	4	6E	-	6B	116	74	9	09
4.4	4.30	-	4.49	114	-	111	4	72	-	6F	115	73	12	0C
4.2	4.10	-	4.29	118	-	115	4	76	-	73	115	73	10	0A
4.0	3.90	-	4.09	122	-	119	4	7A	-	77	115	73	8	08
3.8	3.70	-	3.89	126	-	123	4	7E	-	7B	114	72	11	0B
3.6	3.50	-	3.69	130	-	127	4	82	-	7F	114	72	9	09
3.4	3.30	-	3.49	134	-	131	4	86	-	83	113	71	12	0C
3.2	3.10	-	3.29	138	-	135	4	8A	-	87	113	71	10	0A
3.0	2.90	-	3.09	142	-	139	4	8E	-	8B	113	71	8	08
2.8	2.70	-	2.89	146	-	143	4	92	-	8F	112	70	11	0B
2.6	2.50	-	2.69	150	-	147	4	96	-	93	112	70	9	09
2.4	2.30	-	2.49	154	-	151	4	9A	-	97	111	6F	12	0C
2.2	2.10	-	2.29	158	-	155	4	9E	-	9B	111	6F	10	0A
2.0	1.90	-	2.09	162	-	159	4	A2	-	9F	111	6F	8	08
1.8	1.70	-	1.89	166	-	163	4	A6	-	A3	110	6E	11	0B
1.6	1.50	-	1.69	170	-	167	4	AA	-	A7	110	6E	9	09
1.4	1.30	-	1.49	174	-	171	4	AE	-	AB	109	6D	12	0C
1.2	1.10	-	1.29	178	-	175	4	B2	-	AF	109	6D	10	0A
1.0	0.90	-	1.09	182	-	179	4	B6	-	B3	109	6D	8	08
0.8	0.70	-	0.89	186	-	183	4	BA	-	B7	108	6C	11	0B
0.6	0.50	-	0.69	190	-	187	4	BE	-	BB	108	6C	9	09
0.4	0.30	-	0.49	194	-	191	4	C2	-	BF	107	6B	12	0C
0.2	0.10	-	0.29	198	-	195	4	C6	-	C3	107	6B	10	0A
0.0	-0.10	-	0.09	202	-	199	4	CA	-	C7	107	6B	8	08
-0.2	-0.30	-	-0.11	206	-	203	4	CE	-	CB	107	6B	6	06

dB value	dB range			Range LSB			Span	Range HEX			Transmission code			
	MAX	-	MIN	MAX	-	MIN		MAX	-	MIN	MSB		LSB	
												HEX		HEX
-0.4	-0.50	-	-0.31	210	-	207	4	D2	-	CF	107	6B	4	04
-0.6	-0.70	-	-0.51	214	-	211	4	D6	-	D3	106	6A	7	07
-0.8	-0.90	-	-0.71	218	-	215	4	DA	-	D7	106	6A	5	05
-1.0	-1.10	-	-0.91	222	-	219	4	DE	-	DB	105	69	8	08
-1.2	-1.30	-	-1.11	226	-	223	4	E2	-	DF	105	69	6	06
-1.4	-1.50	-	-1.31	230	-	227	4	E6	-	E3	105	69	4	04
-1.6	-1.70	-	-1.51	234	-	231	4	EA	-	E7	104	68	7	07
-1.8	-1.90	-	-1.71	238	-	235	4	EE	-	EB	104	68	5	05
-2.0	-2.10	-	-1.91	242	-	239	4	F2	-	EF	103	67	8	08
-2.2	-2.30	-	-2.11	246	-	243	4	F6	-	F3	103	67	6	06
-2.4	-2.50	-	-2.31	250	-	247	4	FA	-	F7	103	67	4	04
-2.6	-2.70	-	-2.51	254	-	251	4	FE	-	FB	102	66	7	07
-2.8	-2.90	-	-2.71	258	-	255	4	10	-	FF	102	66	5	05
-3.0	-3.10	-	-2.91	262	-	259	4	10	-	10	101	65	8	08
-3.2	-3.30	-	-3.11	266	-	263	4	10	-	10	101	65	6	06
-3.4	-3.50	-	-3.31	270	-	267	4	10	-	10	101	65	4	04
-3.6	-3.70	-	-3.51	274	-	271	4	11	-	11	100	64	7	07
-3.8	-3.90	-	-3.71	278	-	275	4	11	-	11	100	64	5	05
-4.0	-4.10	-	-3.91	282	-	279	4	11	-	11	99	63	8	08
-4.2	-4.30	-	-4.11	286	-	283	4	11	-	11	99	63	6	06
-4.4	-4.50	-	-4.31	290	-	287	4	12	-	12	99	63	4	04
-4.6	-4.70	-	-4.51	294	-	291	4	12	-	12	98	62	7	07
-4.8	-4.90	-	-4.71	298	-	295	4	12	-	12	98	62	5	05
-5.0	-5.10	-	-4.91	302	-	299	4	12	-	12	97	61	8	08
-5.2	-5.30	-	-5.11	306	-	303	4	13	-	13	97	61	6	06
-5.4	-5.50	-	-5.31	310	-	307	4	13	-	13	97	61	4	04
-5.6	-5.70	-	-5.51	314	-	311	4	13	-	13	96	60	7	07
-5.8	-5.90	-	-5.71	318	-	315	4	13	-	13	96	60	5	05
-6.0	-6.10	-	-5.91	322	-	319	4	14	-	14	95	5F	8	08
-6.2	-6.30	-	-6.11	326	-	323	4	14	-	14	95	5F	6	06
-6.4	-6.50	-	-6.31	330	-	327	4	14	-	14	95	5F	4	04
-6.6	-6.70	-	-6.51	334	-	331	4	14	-	14	94	5E	7	07
-6.8	-6.90	-	-6.71	338	-	335	4	15	-	15	94	5E	5	05
-7.0	-7.10	-	-6.91	342	-	339	4	15	-	15	93	5D	8	08
-7.2	-7.30	-	-7.11	346	-	343	4	15	-	15	93	5D	6	06
-7.4	-7.50	-	-7.31	350	-	347	4	15	-	15	93	5D	4	04
-7.6	-7.70	-	-7.51	354	-	351	4	16	-	16	92	5C	7	07
-7.8	-7.90	-	-7.71	358	-	355	4	16	-	16	92	5C	5	05
-8.0	-8.10	-	-7.91	362	-	359	4	16	-	16	91	5B	8	08
-8.2	-8.30	-	-8.11	366	-	363	4	16	-	16	91	5B	6	06
-8.4	-8.50	-	-8.31	370	-	367	4	17	-	17	91	5B	4	04
-8.6	-8.70	-	-8.51	374	-	371	4	17	-	17	90	5A	7	07
-8.8	-8.90	-	-8.71	378	-	375	4	17	-	17	90	5A	5	05
-9.0	-9.10	-	-8.91	382	-	379	4	17	-	17	89	59	8	08
-9.2	-9.30	-	-9.11	386	-	383	4	18	-	17	89	59	6	06
-9.4	-9.50	-	-9.31	390	-	387	4	18	-	18	89	59	4	04
-9.6	-9.70	-	-9.51	394	-	391	4	18	-	18	88	58	7	07
-9.8	-9.90	-	-9.71	398	-	395	4	18	-	18	88	58	5	05
-10.0	-10.10	-	-9.91	402	-	399	4	19	-	18	87	57	8	08
-10.2	-10.30	-	-10.11	406	-	403	4	19	-	19	87	57	6	06
-10.4	-10.50	-	-10.31	410	-	407	4	19	-	19	87	57	4	04
-10.6	-10.70	-	-10.51	414	-	411	4	19	-	19	86	56	7	07
-10.8	-10.90	-	-10.71	418	-	415	4	1A	-	19	86	56	5	05
-11.0	-11.10	-	-10.91	422	-	419	4	1A	-	1A	85	55	8	08
-11.2	-11.30	-	-11.11	426	-	423	4	1A	-	1A	85	55	6	06
-11.4	-11.50	-	-11.31	430	-	427	4	1A	-	1A	85	55	4	04
-11.6	-11.70	-	-11.51	434	-	431	4	1B	-	1A	84	54	7	07
-11.8	-11.90	-	-11.71	438	-	435	4	1B	-	1B	84	54	5	05
-12.0	-12.10	-	-11.91	442	-	439	4	1B	-	1B	83	53	8	08

dB value	dB range			Range LSB				Span	Range HEX			Transmission code			
				MSB		LSB			MSB		LSB				
	MAX		MIN	MAX		MIN	MAX			MIN	HEX		HEX		HEX
-12.2	-12.30	-	-12.11	446	-	443	4	1B	-	1B	83	53	6	06	
-12.4	-12.50	-	-12.31	450	-	447	4	1C	-	1B	83	53	4	04	
-12.6	-12.70	-	-12.51	454	-	451	4	1C	-	1C	82	52	7	07	
-12.8	-12.90	-	-12.71	458	-	455	4	1C	-	1C	81	52	5	05	
-13.0	-13.10	-	-12.91	462	-	459	4	1C	-	1C	81	51	8	08	
-13.2	-13.30	-	-13.11	466	-	463	4	1D	-	1C	81	51	6	06	
-13.4	-13.50	-	-13.31	470	-	467	4	1D	-	1D	80	51	4	04	
-13.6	-13.70	-	-13.51	474	-	471	4	1D	-	1D	80	50	7	07	
-13.8	-13.90	-	-13.71	478	-	475	4	1D	-	1D	79	50	5	05	
-14.0	-14.10	-	-13.91	482	-	479	4	1E	-	1D	79	4F	8	08	
-14.2	-14.30	-	-14.11	486	-	483	4	1E	-	1E	79	4F	6	06	
-14.4	-14.50	-	-14.31	490	-	487	4	1E	-	1E	78	4F	4	04	
-14.6	-14.70	-	-14.51	494	-	491	4	1E	-	1E	78	4E	7	07	
-14.8	-14.90	-	-14.71	498	-	495	4	1F	-	1E	77	4E	5	05	
-15.0	-15.10	-	-14.91	502	-	499	4	1F	-	1F	77	4D	8	08	
-15.2	-15.30	-	-15.11	506	-	503	4	1F	-	1F	77	4D	6	06	
-15.4	-15.50	-	-15.31	510	-	507	4	1F	-	1F	76	4D	4	04	
-15.6	-15.70	-	-15.51	514	-	511	4	20	-	1F	76	4C	7	07	
-15.8	-15.90	-	-15.71	518	-	515	4	20	-	20	75	4C	5	05	
-16.0	-16.10	-	-15.91	522	-	519	4	20	-	20	75	4B	8	08	
-16.2	-16.30	-	-16.11	526	-	523	4	20	-	20	75	4B	6	06	
-16.4	-16.50	-	-16.31	530	-	527	4	21	-	20	74	4B	4	04	
-16.6	-16.70	-	-16.51	534	-	531	4	21	-	21	74	4A	7	07	
-16.8	-16.90	-	-16.71	538	-	535	4	21	-	21	73	4A	5	05	
-17.0	-17.10	-	-16.91	542	-	539	4	21	-	21	73	49	8	08	
-17.2	-17.30	-	-17.11	546	-	543	4	22	-	21	73	49	6	06	
-17.4	-17.50	-	-17.31	550	-	547	4	22	-	22	73	49	4	04	
-17.6	-17.70	-	-17.51	554	-	551	4	22	-	22	72	48	7	07	
-17.8	-17.90	-	-17.71	558	-	555	4	22	-	22	72	48	5	05	
-18.0	-18.10	-	-17.91	562	-	559	4	23	-	22	71	47	8	08	
-18.2	-18.30	-	-18.11	566	-	563	4	23	-	23	71	47	6	06	
-18.4	-18.50	-	-18.31	570	-	567	4	23	-	23	71	47	4	04	
-18.6	-18.70	-	-18.51	574	-	571	4	23	-	23	70	46	7	07	
-18.8	-18.90	-	-18.71	578	-	575	4	24	-	23	70	46	5	05	
-19.0	-19.10	-	-18.91	582	-	579	4	24	-	24	69	45	8	08	
-19.2	-19.30	-	-19.11	586	-	583	4	24	-	24	69	45	6	06	
-19.4	-19.50	-	-19.31	590	-	587	4	24	-	24	69	45	4	04	
-19.6	-19.70	-	-19.51	594	-	591	4	25	-	24	68	44	7	07	
-19.8	-19.90	-	-19.71	598	-	595	4	25	-	25	68	44	5	05	
-20.0	-20.10	-	-19.91	602	-	599	4	25	-	25	67	43	8	08	
-20.2	-20.30	-	-20.11	606	-	603	4	25	-	25	67	43	6	06	
-20.4	-20.50	-	-20.31	610	-	607	4	26	-	25	67	43	4	04	
-20.6	-20.70	-	-20.51	614	-	611	4	26	-	26	66	42	7	07	
-20.8	-20.90	-	-20.71	618	-	615	4	26	-	26	66	42	5	05	
-21.0	-21.10	-	-20.91	622	-	619	4	26	-	26	65	41	8	08	
-21.2	-21.30	-	-21.11	626	-	623	4	27	-	26	65	41	6	06	
-21.4	-21.50	-	-21.31	630	-	627	4	27	-	27	65	41	4	04	
-21.6	-21.70	-	-21.51	634	-	631	4	27	-	27	64	40	7	07	
-21.8	-21.90	-	-21.71	638	-	635	4	27	-	27	64	40	5	05	
-22.0	-22.10	-	-21.91	642	-	639	4	28	-	27	63	3F	8	08	
-22.2	-22.30	-	-22.11	646	-	643	4	28	-	28	63	3F	6	06	
-22.4	-22.50	-	-22.31	650	-	647	4	28	-	28	63	3F	4	04	
-22.6	-22.70	-	-22.51	654	-	651	4	28	-	28	62	3E	7	07	
-22.8	-22.90	-	-22.71	658	-	655	4	29	-	28	62	3E	5	05	
-23.0	-23.10	-	-22.91	662	-	659	4	29	-	29	61	3D	8	08	
-23.2	-23.30	-	-23.11	666	-	663	4	29	-	29	61	3D	6	06	
-23.4	-23.50	-	-23.31	670	-	667	4	29	-	29	61	3D	4	04	
-23.6	-23.70	-	-23.51	674	-	671	4	2A	-	29	60	3C	7	07	
-23.8	-23.90	-	-23.71	678	-	675	4	2A	-	2A	60	3C	5	05	
-24.0	-24.10	-	-23.91	682	-	679	4	2A	-	2A	59	3B	8	08	

dB value	dB range			Range LSB			Span	Range HEX			Transmission code			
	MAX	-	MIN	MAX	-	MIN		MAX	-	MIN	MSB		LSB	
											HEX	HEX	HEX	HEX
-24.2	-24.30	-	-24.11	686	-	683	4	2A	-	2A	59	3B	6	06
-24.4	-24.50	-	-24.31	690	-	687	4	2B	-	2A	59	3B	4	04
-24.6	-24.70	-	-24.51	694	-	691	4	2B	-	2B	58	3A	7	07
-24.8	-24.90	-	-24.71	698	-	695	4	2B	-	2B	58	3A	5	05
-25.0	-25.10	-	-24.91	702	-	699	4	2B	-	2B	57	39	8	08
-25.2	-25.30	-	-25.11	706	-	703	4	2C	-	2B	57	39	6	06
-25.4	-25.50	-	-25.31	710	-	707	4	2C	-	2C	57	39	4	04
-25.6	-25.70	-	-25.51	714	-	711	4	2C	-	2C	56	38	7	07
-25.8	-25.90	-	-25.71	718	-	715	4	2C	-	2C	56	38	5	05
-26.0	-26.10	-	-25.91	722	-	719	4	2D	-	2C	55	37	8	08
-26.2	-26.30	-	-26.11	726	-	723	4	2D	-	2D	55	37	6	06
-26.4	-26.50	-	-26.31	730	-	727	4	2D	-	2D	55	37	4	04
-26.6	-26.70	-	-26.51	734	-	731	4	2D	-	2D	54	36	7	07
-26.8	-26.90	-	-26.71	738	-	735	4	2E	-	2D	54	36	5	05
-27.0	-27.10	-	-26.91	742	-	739	4	2E	-	2E	53	35	8	08
-27.2	-27.30	-	-27.11	746	-	743	4	2E	-	2E	53	35	6	06
-27.4	-27.50	-	-27.31	750	-	747	4	2E	-	2E	53	35	4	04
-27.6	-27.70	-	-27.51	754	-	751	4	2F	-	2E	52	34	7	07
-27.8	-27.90	-	-27.71	758	-	755	4	2F	-	2F	52	34	5	05
-28.0	-28.10	-	-27.91	762	-	759	4	2F	-	2F	51	33	8	08
-28.2	-28.30	-	-28.11	766	-	763	4	2F	-	2F	51	33	6	06
-28.4	-28.50	-	-28.31	770	-	767	4	30	-	2F	51	33	4	04
-28.6	-28.70	-	-28.51	774	-	771	4	30	-	30	50	32	7	07
-28.8	-28.90	-	-28.71	778	-	775	4	30	-	30	50	32	5	05
-29.0	-29.10	-	-28.91	782	-	779	4	30	-	30	49	31	8	08
-29.2	-29.30	-	-29.11	786	-	783	4	31	-	30	49	31	6	06
-29.4	-29.50	-	-29.31	790	-	787	4	31	-	31	49	31	4	04
-29.6	-29.70	-	-29.51	794	-	791	4	31	-	31	48	30	7	07
-29.8	-29.90	-	-29.71	798	-	795	4	31	-	31	48	30	5	05
-30.0	-30.10	-	-29.91	802	-	799	4	32	-	31	47	2F	8	08
-30.2	-30.30	-	-30.11	806	-	803	4	32	-	32	47	2F	6	06
-30.4	-30.50	-	-30.31	810	-	807	4	32	-	32	47	2F	4	04
-30.6	-30.70	-	-30.51	814	-	811	4	32	-	32	46	2E	7	07
-30.8	-30.90	-	-30.71	818	-	815	4	33	-	32	46	2E	5	05
-31.0	-31.10	-	-30.91	822	-	819	4	33	-	33	45	2D	8	08
-31.2	-31.30	-	-31.11	826	-	823	4	33	-	33	45	2D	6	06
-31.4	-31.50	-	-31.31	830	-	827	4	33	-	33	45	2D	4	04
-31.6	-31.70	-	-31.51	834	-	831	4	34	-	33	44	2C	7	07
-31.8	-31.90	-	-31.71	838	-	835	4	34	-	34	44	2C	5	05
-32.0	-32.10	-	-31.91	842	-	839	4	34	-	34	43	2B	8	08
-32.2	-32.30	-	-32.11	846	-	843	4	34	-	34	43	2B	6	06
-32.4	-32.50	-	-32.31	850	-	847	4	35	-	34	43	2B	4	04
-32.6	-32.70	-	-32.51	854	-	851	4	35	-	35	42	2A	7	07
-32.8	-32.90	-	-32.71	858	-	855	4	35	-	35	42	2A	5	05
-33.0	-33.10	-	-32.91	862	-	859	4	35	-	35	41	29	8	08
-33.2	-33.30	-	-33.11	866	-	863	4	36	-	35	41	29	6	06
-33.4	-33.50	-	-33.31	870	-	867	4	36	-	36	41	29	4	04
-33.6	-33.70	-	-33.51	874	-	871	4	36	-	36	40	28	7	07
-33.8	-33.90	-	-33.71	878	-	875	4	36	-	36	40	28	5	05
-34.0	-34.10	-	-33.91	882	-	879	4	37	-	36	39	27	8	08
-34.2	-34.30	-	-34.11	886	-	883	4	37	-	37	39	27	6	06
-34.4	-34.50	-	-34.31	890	-	887	4	37	-	37	39	27	4	04
-34.6	-34.70	-	-34.51	894	-	891	4	37	-	37	38	26	7	07
-34.8	-34.90	-	-34.71	898	-	895	4	38	-	37	38	26	5	05
-35.0	-35.10	-	-34.91	902	-	899	4	38	-	38	37	25	8	08
-35.2	-35.30	-	-35.11	906	-	903	4	38	-	38	37	25	6	06
-35.4	-35.50	-	-35.31	910	-	907	4	38	-	38	37	25	4	04
-35.6	-35.70	-	-35.51	914	-	911	4	39	-	38	36	24	7	07
-35.8	-35.90	-	-35.71	918	-	915	4	39	-	39	36	24	5	05

dB value	dB range			Range LSB			Span	Range HEX			Transmission code			
	MAX	MIN		MAX	MIN			MAX	MIN		MSB		LSB	
		HEX	HEX		HEX	HEX			HEX	HEX				
-36.0	-36.10	-	-35.91	922	-	919	4	39	-	39	35	23	8	08
-36.2	-36.30	-	-36.11	926	-	923	4	39	-	39	35	23	5	06
-36.4	-36.50	-	-36.31	930	-	927	4	3A	-	39	35	23	4	04
-36.6	-36.70	-	-36.51	934	-	931	4	3A	-	3A	34	22	7	07
-36.8	-36.90	-	-36.71	938	-	935	4	3A	-	3A	34	22	5	05
-37.0	-37.10	-	-36.91	942	-	939	4	3A	-	3A	33	21	8	08
-37.2	-37.30	-	-37.11	946	-	943	4	3B	-	3A	33	21	6	06
-37.4	-37.50	-	-37.31	950	-	947	4	3B	-	3B	33	21	4	04
-37.6	-37.70	-	-37.51	954	-	951	4	3B	-	3B	32	20	7	07
-37.8	-37.90	-	-37.71	958	-	955	4	3B	-	3B	32	20	5	05
-38.0	-38.10	-	-37.91	962	-	959	4	3C	-	3B	31	1F	8	08
-38.2	-38.30	-	-38.11	966	-	963	4	3C	-	3C	31	1F	6	06
-38.4	-38.50	-	-38.31	970	-	967	4	3C	-	3C	31	1F	4	04
-38.6	-38.70	-	-38.51	974	-	971	4	3C	-	3C	30	1E	7	07
-38.8	-38.90	-	-38.71	978	-	975	4	3D	-	3C	30	1E	5	05
-39.0	-39.10	-	-38.91	982	-	979	4	3D	-	3D	29	1D	8	08
-39.2	-39.30	-	-39.11	986	-	983	4	3D	-	3D	29	1D	6	06
-39.4	-39.50	-	-39.31	990	-	987	4	3D	-	3D	29	1D	4	04
-39.6	-39.70	-	-39.51	994	-	991	4	3E	-	3D	28	1C	7	07
-39.8	-39.90	-	-39.71	998	-	995	4	3E	-	3E	28	1C	5	05
-40.0	-40.40	-	-39.91	1008	-	999	10	3F	-	3E	27	1B	8	08
-41.0	-41.40	-	-40.41	1028	-	1009	20	40	-	3F	26	1A	8	08
-42.0	-42.40	-	-41.41	1048	-	1029	20	41	-	40	25	19	8	08
-43.0	-43.40	-	-42.41	1068	-	1049	20	42	-	41	24	18	8	08
-44.0	-44.40	-	-43.41	1088	-	1069	20	44	-	42	23	17	8	08
-45.0	-45.40	-	-44.41	1108	-	1089	20	45	-	44	22	16	8	08
-46.0	-46.40	-	-45.41	1128	-	1109	20	46	-	45	21	15	8	08
-47.0	-47.40	-	-46.41	1148	-	1129	20	47	-	46	20	14	8	08
-48.0	-48.40	-	-47.41	1168	-	1149	20	49	-	47	19	13	8	08
-49.0	-49.40	-	-48.41	1188	-	1169	20	4A	-	49	18	12	8	08
-50.0	-50.40	-	-49.41	1208	-	1189	20	4B	-	4A	17	11	8	08
-51.0	-51.40	-	-50.41	1228	-	1209	20	4C	-	4B	16	10	8	08
-52.0	-52.40	-	-51.41	1248	-	1229	20	4E	-	4C	15	F	8	08
-53.0	-53.40	-	-52.41	1268	-	1249	20	4F	-	4E	14	E	8	08
-54.0	-54.40	-	-53.41	1288	-	1269	20	50	-	4F	13	D	8	08
-55.0	-55.40	-	-54.41	1308	-	1289	20	51	-	50	12	C	8	08
-56.0	-56.40	-	-55.41	1328	-	1309	20	53	-	51	11	B	8	08
-57.0	-57.40	-	-56.41	1348	-	1329	20	54	-	53	10	A	8	08
-58.0	-58.40	-	-57.41	1368	-	1349	20	55	-	54	9	9	8	08
-59.0	-59.40	-	-58.41	1388	-	1369	20	56	-	55	8	8	8	08
-60.0	-60.40	-	-59.41	1408	-	1389	20	58	-	56	7	7	8	08
-62.0	-63.00	-	-60.41	1460	-	1409	52	5B	-	58	6	6	8	08
-64.0	-65.00	-	-63.01	1500	-	1461	40	5D	-	5B	5	5	8	08
-66.0	-67.00	-	-65.01	1540	-	1501	40	60	-	5D	4	4	8	08
-68.0	-69.00	-	-67.01	1580	-	1541	40	62	-	60	3	3	8	08
-70.0	-74.99	-	-69.01	1700	-	1581	120	6A	-	62	2	2	8	08
-80.0	-80.49	-	-75.00	1810	-	1701	110	71	-	6A	1	1	8	08
OFF	****	-	-80.50	4095	-	1811	2285	FF	-	71	0	0	8	08

■ MIDI Handshake Feature

● Functions Specified for MIDI Handshake Feature

- Selecting function
 - [Data relocation between current and memory]
 - 1) Transfer the contents of specified memory locations from 128 memory to current. (30H)
 - 2) Execute ADVANCE. (31H)
 - 3) Store the current data into specified memory. (38H)
 - [Data relocation between memory and external]
 - 4) Register data with memory. (40H)
 - 5) Request to send the contents (data) of memory. (48H)
 - [Data relocation between current and external]
 - 6) Set data into current. (50H)
 - 7) Set data into parameter. (52H)
 - 8) Request to send the current data. (58H)
 - 9) Request to send the current memory number. (59H)
 - 10) Request to send parameter data. (5AH)
 - [System data relocation]
 - 11) Request to send system data. (20H)
- Polling function
 - 1) Return the contents (data) of memory. (48H)
 - 2) Return the current data. (58H)
 - 3) Return the current memory number. (59H)
 - 4) Return parameter data. (5AH)
 - 5) Return system data (status). (20H)

● Text Data Format

(1) Memory number (2 bytes)

- The applicable selecting commands are listed below:

CMD	Command name	Description
30H	MEMORY RECALL	Move the contents of specified memory from 128 memory to the current.
38H	MEMORY STORE	Store the current data into the specified memory.
59H	MEMORY No. RETURN	Return the current memory number.

- The text data configuration is shown below:

Current data		Description	
HEADER	F0H	START OF EXCLUSIVE	
	54H	Matsushita's communication ID code	
	11H	Format No.	
	02H	START OF TEXT	
CMD		30H : MEMORY RECALL, 38H : MEM STORE, 59H : MEM No. RET	
DATA	MEM No.	MSB	Memory No. Two-digit hex memory number in ASCII.
	MEM No.	LSB	
FOOTER	03H	END OF TEXT	
	BCC	XOR of CMD through ETX	
	DSZ	Number of data from CMD through the last data. "03" for this text.	
	F7H	END OF TEXT	

- Memory number is an ASCII code in hex.
- Memory number to be transferred is (the value displayed on 7-segment display - 1).
- For example, when memory number is "1", value "00" is transferred. When memory number is "128", value "7F" is transferred.
- Memory number is a number corresponding to the data shown on the 7-segment display and is not a program number.
- When MEMORY RECALL is executed, it requires processing timeup to execution. Therefore, any continuous transmission must be made at the intervals of more than 130msec (90msec if active mode switch 8 is set OFF).
- NAK will be returned if the memory number specified by MEMORY RECALL or MEMORY STORE exceeds 128 (7FH).
- When MEMORY STORE is executed, the destination memory number is displayed in manual mode. However, this command does not affect memory number.

(2) Pattern number (4 bytes) with range specification

- The applicable selecting commands are listed in the following:

CMD	Command name	Description
48H	MEMORY REQUEST	Request to send the contents of memory.

- Text data configuration is shown in the following:

Current data		Description	
HEADER	F0H	START OF EXCLUSIVE	
	54H	Matsushita's communication ID code	
	11H	Format No.	
	02H	START OF TEXT	
CMD		48H : MEMORY REQUEST	
ATR		Request data type '0': Channel mute data '1': Mute execution data '2': Mute group data '3': VCA group data '4': Input fader level	
First memory	MEM No.	MSB	First memory No. Two-digit hex memory number in ASCII.
	MEM No.	LSB	
Last memory	MEM No.	MSB	Last memory No. Two-digit hex memory number in ASCII.
	MEM No.	LSB	
FOOTER	03H	END OF TEXT	
	BCC	XOR of CMD through ETX.	
	DSZ	Number of data from CMD through last data. "05" for this text.	
	F7H	END OF EXCLUSIVE	

3) Memory Data

- The following shows the applicable selecting and polling commands:

CMD	Command name	Description
40H	MEMORY WRITE	Registers the memory data.
48H	MEMORY RETURN	Returns the contents of memory.

- ① First text (when data exceeds 255 bytes)

Current data		Description	
HEADER	F0H	START OF EXCLUSIVE	
	54H	Matsushita's communication ID code	
	11H	Format No.	
	02H	START OF TEXT	
CMD		40H : MEMORY WRITE 48H : MEMORY RETURN	
ATR		Request data type '0': Channel memory data '1': Mute group data '2': Mute group data '3': VCA group data '4': Input fader level	
First memory	MEM No.	MSB	First memory No. Two-digit hex memory number in ASCII.
	MEM No.	LSB	
Last memory	MEM No.	MSB	Last memory No. Two-digit hex memory number in ASCII.
	MEM No.	LSB	
Memory data		String of type memory data	
FOOTER	17H	END OF TEXT BLOCK	
	BCC	XOR of CMD through ETB.	
	DSZ	Number of data from CMD through last data. "05" for this text.	
	F7H	END OF EXCLUSIVE	

- ② Text in the middle

Current data		Description	
HEADER	F0H	START OF EXCLUSIVE	
	54H	Matsushita's communication ID code	
	11H	Format No.	
	02H	START OF TEXT	
Memory data		String of type memory data	
FOOTER	17H	END OF TEXT BLOCK	
	BCC	XOR of CMD through ETB	
	DSZ	Byte count of on-line memory data in this frame	
	F7H	END OF EXCLUSIVE	

- ③ Last text

Current data		Description	
HEADER	F0H	START OF EXCLUSIVE	
	54H	Matsushita's communication ID code	
	11H	Format No.	
	02H	START OF TEXT	
Memory data		Last of string of type memory data	
FOOTER	17H	END OF TEXT	
	BCC	XOR of first data through ETX	
	DSZ	Number of data from first data through last data	
	F7H	END OF EXCLUSIVE	

(4) Current Data

- The following shows the applicable selecting and polling commands:

CMD	Command name	Description
50H	CURRENT SET	Registers data to current.
58H	CURRENT RETURN	Returns the contents of current.

- Text data configuration is shown in the following:

Current data		Description	
HEADER	F0H	START OF EXCLUSIVE	
	54H	Matsushita's communication ID code	
	11H	Format No.	
	02H	START OF TEXT	
CMD		50H : CURRENT SET, 58H : CURRENT RETURN	
ATR		Request data type '0': Channel memory data '1': Mute group execution data '2': Mute group data '3': VCA group data '4': Input fader level	
LOCK		30H—33H : OFF, 34H—37H : ON	
Data string		Single type memory data	
FOOTER	03H	END OF TEXT	
	BCC	XOR of CMD through ETX.	
	DSZ	Number of data from CMD through last data.	
	F7H	END OF EXCLUSIVE	

(5) Parameter Data

- The following shows the applicable selecting and polling commands:

CMD	Command name	Description
52H	PARAMETER SET	Sets data into parameter.
5AH	PARAMETER RETURN	Returns parameter.

- Text data configuration is shown in the following:

Current data		Description	
HEADER	F0H	START OF EXCLUSIVE	
	54H	Matsushita's communication ID code	
	11H	Format No.	
	02H	START OF TEXT	
CMD		52H : PARAMETER SET, 5AH : PARAMETER RETURN	
Parameter No. MSB		MSB of NRPN is employed.	
Parameter No. LSB		LSB of NRPN is employed.	
Data	MSB	NRPN's data entry value is employed for ASCII coded two-digit data value.	
	MSB		
	LSB	when LSB is not used, 30H is employed.	
	LSB		
FOOTER	03H	END OF TEXT	
	BCC	XOR of CMD through ETX.	
	DSZ	Number of data from CMD through last data.	
	F7H	END OF EXCLUSIVE	

- LSB data should be " " (20H) during MSB format.

- Refer to transmission intervals on page 66.

(6) Parameter Data Request

- The following shows the applicable selecting commands:

CMD	Command name	Description
5AH	PARAMETER REQUEST	Request to send parameter.

- Text data configuration is shown in the following:

Current data		Description
HEADER	F0H	START OF EXCLUSIVE
	54H	Matsushita's communication ID code
	11H	Format No.
	02H	START OF TEXT
CMD		5AH : PARAMETER RETURN
Parameter No. MSB		MSB of NRPN is employed.
Parameter No. LSB		LSB of NRPN is employed.
FOOTER	03H	END OF TEXT
	BCC	XOR of CMD through ETX.
	DSZ	Number of data from CMD through last data.
	F7H	END OF EXCLUSIVE

Notes: · "30" is sent for the LSB of data other than VCA value.
 · The LSB of received data other than VCA value is ignored.

(7) System Data

- The following shows the applicable selecting and polling commands:

CMD	Command name	Description
20H	STATUS RETURN	Returns the contents of current.

- Text data configuration is shown in the following:

Current data		Description
HEADER	F0H	START OF EXCLUSIVE
	54H	Matsushita's communication ID code
	11H	Format No.3
	02H	START OF TEXT
CMD		20H : STATUS RETURN
STATUS		STATUS
INT SW1		MSB of internal DIP switch
INT SW2		LSB of internal DIP switch
FOOTER	03H	END OF TEXT
	BCC	XOR of CMD through ETX
	DSZ	Number of data from CMD through last data
	F7H	END OF EXCLUSIVE

(8) Current Data Request

- The following shows the applicable selecting commands:

CMD	Command name	Description
58H	CURRENT REQUEST	Request to send current data.

- Text data configuration is shown in the following:
- Once selecting is received, this text data is sent until other selecting is received next.

Current data		Description
HEADER	F0H	START OF EXCLUSIVE
	54H	Matsushita's communication ID code
	11H	Format No.
	02H	START OF TEXT
CMD		58H : CURRENT REQUEST,
ATR		Request data type '0': Channel memory data '1': Mute group execution data '2': Mute group data '3': VCA group data '4': Input fader level
FOOTER	03H	END OF TEXT
	BCC	XOR of CMD through ETX
	DSZ	Number of data from CMD through last data.
	F7H	END OF EXCLUSIVE

(9) Text with no data affiliated

- The following shows the applicable selecting commands:

CMD	Command name	Description
20H	STATUS REQUEST	Request to send system data.
31H	ADVANCE EXECUTE	Execute ADVANCE.
59H	MEMORY No. REQUEST	Request to send the current memory number.

- Text data configuration is shown in the following:
- Once selecting is received, this text data is sent until other selecting is received next.

Current data		Description
HEADER	F0H	START OF EXCLUSIVE
	54H	Matsushita's communication ID code
	11H	Format No.
	02H	START OF TEXT
CMD		20H : STATUS REQUEST, 31H : ADVANCE EXECUTION 59H : MEMORY No. REQUEST
FOOTER	03H	END OF TEXT
	BCC	XOR of CMD through ETX.
	DSZ	Number of data from CMD through last data.
	F7H	END OF EXCLUSIVE

● Memory Data Format

Hex numerals "0" through "F" are used for the following data:

(1) Mute data

Memory data format			
No.	Function and value		
	Parameter name	Setting range	Data range
1	CH 5—8	ON/OFF	'0'-'F'; Corresponds to each bit. H:ON, L:OFF
2	CH 1—4	ON/OFF	'0'-'F'; Corresponds to each bit. H:ON, L:OFF
3	CH 13—16	ON/OFF	'0'-'F'; Corresponds to each bit. H:ON, L:OFF
4	CH 9—12	ON/OFF	'0'-'F'; Corresponds to each bit. H:ON, L:OFF
5	CH 21—24	ON/OFF	'0'-'F'; Corresponds to each bit. H:ON, L:OFF
6	CH 17—20	ON/OFF	'0'-'F'; Corresponds to each bit. H:ON, L:OFF
7	CH 29—32	ON/OFF	'0'-'F'; Corresponds to each bit. H:ON, L:OFF
8	CH 25—28	ON/OFF	'0'-'F'; Corresponds to each bit. H:ON, L:OFF
9	CH 37—40	ON/OFF	'0'-'F'; Corresponds to each bit. H:ON, L:OFF
10	CH 33—36	ON/OFF	'0'-'F'; Corresponds to each bit. H:ON, L:OFF
11	CH 45—48	ON/OFF	'0'-'F'; Corresponds to each bit. H:ON, L:OFF
12	CH 41—44	ON/OFF	'0'-'F'; Corresponds to each bit. H:ON, L:OFF
13	AUX 1—4	ON/OFF	'0'-'F'; Corresponds to each bit. H:ON, L:OFF
14	CH 49—52	ON/OFF	'0'-'F'; Corresponds to each bit. H:ON, L:OFF
15	AUX 9—12	ON/OFF	'0'-'F'; Corresponds to each bit. H:ON, L:OFF
16	AUX 5—8	ON/OFF	'0'-'F'; Corresponds to each bit. H:ON, L:OFF
17	AUX 17—20	ON/OFF	'0'-'F'; Corresponds to each bit. H:ON, L:OFF
18	AUX 13—16	ON/OFF	'0'-'F'; Corresponds to each bit. H:ON, L:OFF

(2) Mute group execution data

Memory data format			
No.	Function and value		
	Parameter name	Setting range	Data range
1	MUTE GROUP 5—8	ON/OFF	'0'-'F'; Corresponds to each bit. H:ON, L:OFF
2	MUTE GROUP 1—4	ON/OFF	'0'-'F'; Corresponds to each bit. H:ON, L:OFF
3	Dummy	—	'0'
4	MUTE GROUP 9—10	ON/OFF	'0'-'F'; Corresponds to each bit. H:ON, L:OFF

(3) Mute group data

Memory data format			
No.	Function and value		
	Parameter name	Setting range	Data range
1	MUTE G0/CH 5—8	ON/OFF	'0'-'F'; Corresponds to each bit. H:ON, L:OFF
2	MUTE G0/CH 1—4	ON/OFF	'0'-'F'; Corresponds to each bit. H:ON, L:OFF
3	MUTE G0/CH 13—16	ON/OFF	'0'-'F'; Corresponds to each bit. H:ON, L:OFF
4	MUTE G0/CH 9—12	ON/OFF	'0'-'F'; Corresponds to each bit. H:ON, L:OFF
5	MUTE G0/CH 21—24	ON/OFF	'0'-'F'; Corresponds to each bit. H:ON, L:OFF
6	MUTE G0/CH 17—20	ON/OFF	'0'-'F'; Corresponds to each bit. H:ON, L:OFF
7	MUTE G0/CH 29—32	ON/OFF	'0'-'F'; Corresponds to each bit. H:ON, L:OFF
8	MUTE G0/CH 25—28	ON/OFF	'0'-'F'; Corresponds to each bit. H:ON, L:OFF
9	MUTE G0/CH 37—40	ON/OFF	'0'-'F'; Corresponds to each bit. H:ON, L:OFF
10	MUTE G0/CH 33—36	ON/OFF	'0'-'F'; Corresponds to each bit. H:ON, L:OFF
11	MUTE G0/CH 45—48	ON/OFF	'0'-'F'; Corresponds to each bit. H:ON, L:OFF
12	MUTE G0/CH 41—44	ON/OFF	'0'-'F'; Corresponds to each bit. H:ON, L:OFF
13	MUTE G0/AUX 1—4	ON/OFF	'0'-'F'; Corresponds to each bit. H:ON, L:OFF
14	MUTE G0/CH 49—52	ON/OFF	'0'-'F'; Corresponds to each bit. H:ON, L:OFF
15	MUTE G0/AUX 9—12	ON/OFF	'0'-'F'; Corresponds to each bit. H:ON, L:OFF
16	MUTE G0/AUX 5—8	ON/OFF	'0'-'F'; Corresponds to each bit. H:ON, L:OFF
17	MUTE G0/AUX 17—20	ON/OFF	'0'-'F'; Corresponds to each bit. H:ON, L:OFF
18	MUTE G0/AUX 13—16	ON/OFF	'0'-'F'; Corresponds to each bit. H:ON, L:OFF
19 36	MUTE G1 CH1—AUX20	ON/OFF	'0'-'F'; Corresponds to each bit. H:ON, L:OFF
37 54	MUTE G2 CH1—AUX20	ON/OFF	'0'-'F'; Corresponds to each bit. H:ON, L:OFF
55 72	MUTE G3 CH1—AUX20	ON/OFF	'0'-'F'; Corresponds to each bit. H:ON, L:OFF
73 90	MUTE G4 CH1—AUX20	ON/OFF	'0'-'F'; Corresponds to each bit. H:ON, L:OFF
91 108	MUTE G5 CH1—AUX20	ON/OFF	'0'-'F'; Corresponds to each bit. H:ON, L:OFF
109 126	MUTE G6 CH1—AUX20	ON/OFF	'0'-'F'; Corresponds to each bit. H:ON, L:OFF
127 144	MUTE G7 CH1—AUX20	ON/OFF	'0'-'F'; Corresponds to each bit. H:ON, L:OFF
145 162	MUTE G8 CH1—AUX20	ON/OFF	'0'-'F'; Corresponds to each bit. H:ON, L:OFF
163 180	MUTE G9 CH1—AUX20	ON/OFF	'0'-'F'; Corresponds to each bit. H:ON, L:OFF
181 198	MUTE G10 CH1—AUX20	ON/OFF	'0'-'F'; Corresponds to each bit. H:ON, L:OFF

Note: Each bit is lined from MSB side in turns of bigger channel as shown below.

ex)

CH4 CH3 CH2 CH1

OFF OFF ON ON → 0 0 1 1 → "3" → 33H
(ASCII code)

(4) VCA group data

Memory data format			
Function and value			
No	Parameter name	Setting range	Data range
1	VCA G1/ CH 5-8	ON/OFF	'0'-'F', Corresponds to each bit. H:ON, L:OFF
2	VCA G1/ CH 1-4	ON/OFF	'0'-'F', Corresponds to each bit. H:ON, L:OFF
3	VCA G1/ CH 13-16	ON/OFF	'0'-'F', Corresponds to each bit. H:ON, L:OFF
4	VCA G1/ CH 9-12	ON/OFF	'0'-'F', Corresponds to each bit. H:ON, L:OFF
5	VCA G1/ CH 21-24	ON/OFF	'0'-'F', Corresponds to each bit. H:ON, L:OFF
6	VCA G1/ CH 17-20	ON/OFF	'0'-'F', Corresponds to each bit. H:ON, L:OFF
7	VCA G1/ CH 29-32	ON/OFF	'0'-'F', Corresponds to each bit. H:ON, L:OFF
8	VCA G1/ CH 25-28	ON/OFF	'0'-'F', Corresponds to each bit. H:ON, L:OFF
9	VCA G1/ CH 37-40	ON/OFF	'0'-'F', Corresponds to each bit. H:ON, L:OFF
10	VCA G1/ CH 33-36	ON/OFF	'0'-'F', Corresponds to each bit. H:ON, L:OFF
11	VCA G1/ CH 45-48	ON/OFF	'0'-'F', Corresponds to each bit. H:ON, L:OFF
12	VCA G1/ CH 41-44	ON/OFF	'0'-'F', Corresponds to each bit. H:ON, L:OFF
13	Dummy	---	'0'
14	VCA G1/ CH 49-52	ON/OFF	'0'-'F', Corresponds to each bit. H:ON, L:OFF
15	VCA G2/ CH1-CH52	ON/OFF	'0'-'F', Corresponds to each bit. H:ON, L:OFF
28			
29	VCA G3/ CH1-CH52	ON/OFF	'0'-'F', Corresponds to each bit. H:ON, L:OFF
42			
43	VCA G4/ CH1-CH52	ON/OFF	'0'-'F', Corresponds to each bit. H:ON, L:OFF
56			
57	VCA G5/ CH1-CH52	ON/OFF	'0'-'F', Corresponds to each bit. H:ON, L:OFF
70			
71	VCA G6/ CH1-CH52	ON/OFF	'0'-'F', Corresponds to each bit. H:ON, L:OFF
84			
85	VCA G7/ CH1-CH52	ON/OFF	'0'-'F', Corresponds to each bit. H:ON, L:OFF
98			
99	VCA G8/ CH1-CH52	ON/OFF	'0'-'F', Corresponds to each bit. H:ON, L:OFF
112			
113	VCA G9/ CH1-CH52	ON/OFF	'0'-'F', Corresponds to each bit. H:ON, L:OFF
126			
127	VCA G10/ CH10-CH52	ON/OFF	'0'-'F', Corresponds to each bit. H:ON, L:OFF
140			

(5) VCA data

Memory data format			
Function and value			
No	Parameter name	Setting range	Data range
1	VCA CH 1	"0000"-7FF0"	Refer to LVL data table Upper 2 characters are for coarse adjustment over +10 dB to -80 dB Lower one character is for fine adjustment in a 0.1 dB increment
5	VCA CH 2	"0000"-7FF0"	
9	VCA CH 3	"0000"-7FF0"	
13	VCA CH 4	"0000"-7FF0"	
17	VCA CH 5	"0000"-7FF0"	
21	VCA CH 6	"0000"-7FF0"	
25	VCA CH 7	"0000"-7FF0"	
29	VCA CH 8	"0000"-7FF0"	
33	VCA CH 9	"0000"-7FF0"	
37	VCA CH 10	"0000"-7FF0"	
41	VCA CH 11	"0000"-7FF0"	
45	VCA CH 12	"0000"-7FF0"	
49	VCA CH 13	"0000"-7FF0"	
53	VCA CH 14	"0000"-7FF0"	
57	VCA CH 15	"0000"-7FF0"	
61	VCA CH 16	"0000"-7FF0"	
		
189	VCA CH 48	"0000"-7FF0"	
193	VCA CH 49	"0000"-7FF0"	
197	VCA CH 50	"0000"-7FF0"	
201	VCA CH 51	"0000"-7FF0"	
205	VCA CH 52	"0000"-7FF0"	

ex) "6B8" data of 0dB is shown in the following

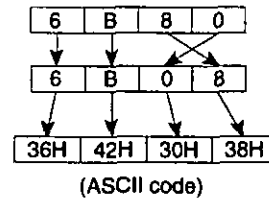

● Message Control Message

The messages used for message control are shown in the following.

They are transferred according to the text and Matsushita's exclusive format described earlier.

(1) Polling message [POL]

POL	Code (hex)	Description
SOX	F0	START OF EXCLUSIVE
IDC	54	Matsushita's communication ID code
FMT	11	Format No.
SOH	01	START OF HEADER
md	42	Model name code for WR-SX1 Series
ua	20H-2FH	[(MIDI CH] - 1) + 20H
pol	50 'P'	Indicates that this message is POL.
EOX	F7	END OF EXCLUSIVE

(2) Selecting message [SEL]

POL	Code (hex)	Description
SOX	F0	START OF EXCLUSIVE
IDC	54	Matsushita's communication ID code
FMT	11	Format No.
SOH	01	START OF HEADER
md	42	Model name code for WR-SX1 Series
ua	20H-2FH	[(MIDI CH] - 1) + 20H
sel	53 'S'	Indicates that this message is SEL.
EOX	F7	END OF EXCLUSIVE

(3) Acknowledgement message [ACK]

POL	Code (hex)	Description
SOX	F0	START OF EXCLUSIVE
IDC	54	Matsushita's communication ID code
FMT	11	Format No.
ack	06 'AK'	Indicates that this message is ACK.
EOX	F7	END OF EXCLUSIVE

(4) Nacknowledgement message [NAK]

POL	Code (hex)	Description
SOX	F0	START OF EXCLUSIVE
IDC	54	Matsushita's communication ID code
FMT	11	Format No.
nak	15 'NK'	Indicates that this message is NAK.
EOX	F7	END OF EXCLUSIVE

(5) End of Text message [EOT]

POL	Code (hex)	Description
SOX	F0	START OF EXCLUSIVE
IDC	54	Matsushita's communication ID code
FMT	11	Format No.
eot	04 'ET'	Indicates that this message is EOT.
EOX	F7	END OF EXCLUSIVE

● Non-Procedure Memory Change

- When this message is received, the specified memory is read.
- Memory number matches the internal memory number (shown on the 7-segment display).
- When md=00H, model name code is not compared.
- When ua=00H, unit address is not compared.

POL	Code (hex)	Description
SOX	F0	START OF EXCLUSIVE
IDC	54	Matsushita's communication ID code
FMT	11	Format No.
ESC	1B	Escape Sequence Start
md	42	Model name code for WR-SX1 Series
ua	20H-2FH	[(MIDI CH] - 1) + 20H
MEM No. MSB	'0'-'7'	ASCII coded two digit "7F" when memory number 128 is specified.
MEM No. MSB	'0'-'F'	
EOX	F7	END OF EXCLUSIVE

■ MIDI One-Way Feature

● Functions Specified for MIDI One-Way Feature

- Selecting function
[Data relocation between memory and external]
- 1) Register data with memory (40H)
[Data relocation between current and external]
- 2) Set data into current (50H)
- 3) Set data into parameter (52H)
- Polling function
- 1) Request to send memory data (48H)
- 2) Request to send current data (58H)

● Selecting Message Format

(1) Data registration with memory (MEMORY SET)

Current data		Description
HEADER	F0H	START OF EXCLUSIVE
	54H	Matsushita's communication ID code
	12H	Format No. 12H (one way)
	42H	Model name code for Audio Mixer WR-SX1
	MDC	[MIDI CH] -1+20H
	53H	Selecting Message
CMD		40H : MEMORY SET
ATR		Data type: '0': Channel memory data '1': Mute group execution data '2': Mute group data '3': VCA group data '4': Input fader level
Memory No.	MEM No.	Memory number. Two-digit hex memory number in ASCII.
	MEM No.	
Memory data		Single memory data
FOOTER	03H	END OF TEXT
	BCC	XOR of CMD through ETX
	F7H	END OF EXCLUSIVE

(2) Data registration with current (CURRENT SET)

Current data		Description
HEADER	F0H	START OF EXCLUSIVE
	54H	Matsushita's communication ID code
	12H	Format No. 12H (ONE WAY)
	42H	Model name code for Audio Mixer WR-SX1
	MDC	[MIDI CH] -1+20H
	53H	Selecting Message
CMD		50H : CURRENT SET
ATR		Data type: '0': Channel memory data '1': Mute group execution data '2': Mute group data '3': VCA group data '4': Input fader level
LOCK		30H-33H : OFF, 34H-37H : ON
Data string		Single memory data
FOOTER	03H	END OF TEXT
	BCC	XOR of CMD through ETX
	F7H	END OF EXCLUSIVE

(3) Data registration with parameter (PARAMETER SET)

PARAMETER SET		Description
HEADER	F0H	START OF EXCLUSIVE
	54H	Matsushita's communication ID code
	12H	Format No. 12H (ONE WAY)
	42H	Model name code for Audio Mixer WR-SX1
	MDC	[MIDI CH] -1+20H
	53H	Selecting Message
CMD		52H : PARAMETER SET
Parameter No. MSB		MSB of NRPN is employed.
Parameter No. LSB		LSB of NRPN is employed.
Data	MSB	The data value of ASCII coded two-digit employs the data entry value of NRPN.
	MSB	
	LSB	
	LSB	
FOOTER	03H	END OF TEXT
	BCC	XOR of CMD through ETX
	F7H	END OF EXCLUSIVE

- LOCK ON/OFF Control is not available.
- Unless otherwise specified, "0" is sent for unspecified LSB data.

● Polling Message Format

For the continuous data transmission, 50m sec. or more interval should be required.

(1) Request to send memory data (MEMORY REQUEST)

MEMORY REQUEST		Description
HEADER	F0H	START OF EXCLUSIVE
	54H	Matsushita's communication ID code
	12H	Format No. 12H (one way)
	42H	Model name code for Audio Mixer WR-SX1
	MDC	[MIDI CH] -1+20H
	50H	Poling Message
CMD		48H : MEMORY REQUEST
ATR		Data type: '0': Channel memory data '1': Mute group execution data '2': Mute group data '3': VCA group data '4': Input fader level
FOOTER	MEM No.	Two-digit hex memory number in ASCII
	MEM No.	
Memory No.	03H	END OF TEXT
	BCC	XOR of CMD through ETX
	F7H	END OF EXCLUSIVE

(2) Request to send data to current (CURRENT REQUEST)

MEMORY REQUEST		Description
HEADER	F0H	START OF EXCLUSIVE
	54H	Matsushita's communication ID code
	12H	Format No. 12H (one way)
	42H	Model name code for Audio Mixer WR-SX1
	MDC	[MIDI CH] -1+20H
	50H	Poling Message
CMD		58H : CURRENT REQUEST
ATR		Data type: '0': Channel memory data '1': Mute group execution data '2': Mute group data '3': VCA group data '4': Input fader level
FOOTER	03H	END OF TEXT
	BCC	XOR of CMD through ETX
	F7H	END OF EXCLUSIVE

Parameter Table

Input Fader Level Value

No.	Parameter name	Numerical range
1	LVL (MSB)	OFF, -60 – +10[dB] 0.5dB Step (+10– -40dB) 1dB Step (-40– -60dB) 2dB Step (-60– -70dB) 10dB Step (-70– -80dB)

(1) Value of MSB

PARM value	LVL value	PARM value	LVL value	PARM value	LVL value	PARM value	LVL value
0 (00H)	OFF	32 (20H)	-37.5	64 (40H)	-21.5	96 (60H)	-5.5
1 (01H)	-80.0 dB	33 (21H)	-37.0	65 (41H)	-21.0	97 (61H)	-5.0
2 (02H)	-70.0	34 (22H)	-36.5	66 (42H)	-20.5	98 (62H)	-4.5
3 (03H)	-68.0	35 (23H)	-36.0	67 (43H)	-20.0	99 (63H)	-4.0
4 (04H)	-66.0	36 (24H)	-35.5	68 (44H)	-19.5	100 (64H)	-3.5
5 (05H)	-64.0	37 (25H)	-35.0	69 (45H)	-19.0	101 (65H)	-3.0
6 (06H)	-62.0	38 (26H)	-34.5	70 (46H)	-18.5	102 (66H)	-2.5
7 (07H)	-60.0	39 (27H)	-34.0	71 (47H)	-18.0	103 (67H)	-2.0
8 (08H)	-59.0	40 (28H)	-33.5	72 (48H)	-17.5	104 (68H)	-1.5
9 (09H)	-58.0	41 (29H)	-33.0	73 (49H)	-17.0	105 (69H)	-1.0
10 (0AH)	-57.0	42 (2AH)	-32.5	74 (4AH)	-16.5	106 (6AH)	-0.5
11 (0BH)	-56.0	43 (2BH)	-32.0	75 (4BH)	-16.0	107 (6BH)	0.0 [dB]
12 (0CH)	-55.0	44 (2CH)	-31.5	76 (4CH)	-15.5	108 (6CH)	+0.5
13 (0DH)	-54.0	45 (2DH)	-31.0	77 (4DH)	-15.0	109 (6DH)	+1.0
14 (0EH)	-53.0	46 (2EH)	-30.5	78 (4EH)	-14.5	110 (6EH)	+1.5
15 (0FH)	-52.0	47 (2FH)	-30.0	79 (4FH)	-14.0	111 (6FH)	+2.0
16 (10H)	-51.0	48 (30H)	-29.5	80 (50H)	-13.5	112 (70H)	+2.5
17 (11H)	-50.0	49 (31H)	-29.0	81 (51H)	-13.0	113 (71H)	+3.0
18 (12H)	-49.0	50 (32H)	-28.5	82 (52H)	-12.5	114 (72H)	+3.5
19 (13H)	-48.0	51 (33H)	-28.0	83 (53H)	-12.0	115 (73H)	+4.0
20 (14H)	-47.0	52 (34H)	-27.5	84 (54H)	-11.5	116 (74H)	+4.5
21 (15H)	-46.0	53 (35H)	-27.0	85 (55H)	-11.0	117 (75H)	+5.0
22 (16H)	-45.0	54 (36H)	-26.5	86 (56H)	-10.5	118 (76H)	+5.5
23 (17H)	-44.0	55 (37H)	-26.0	87 (57H)	-10.0 dB	119 (77H)	+6.0
24 (18H)	-43.0	56 (38H)	-25.5	88 (58H)	-9.5	120 (78H)	+6.5
25 (19H)	-42.0	57 (39H)	-25.0	89 (59H)	-9.0	121 (79H)	+7.0
26 (1AH)	-41.0	58 (3AH)	-24.5	90 (5AH)	-8.5	122 (7AH)	+7.5
27 (1BH)	-40.0	59 (3BH)	-24.0	91 (5BH)	-8.0	123 (7BH)	+8.0
28 (1CH)	-39.5	60 (3CH)	-23.5	92 (5CH)	-7.5	124 (7CH)	+8.5
29 (1DH)	-39.0	61 (3DH)	-23.0	93 (5DH)	-7.0	125 (7DH)	+9.0
30 (1EH)	-38.5	62 (3EH)	-22.5	94 (5EH)	-6.5	126 (7EH)	+9.5
31 (1FH)	-38.0	63 (3FH)	-22.0	95 (5FH)	-6.0	127 (7FH)	+10.0

(2) Value of LSB

LSB of control change	ASCII	LVL compensation value
0 (00H)	'0'	-0.8 dB
1 (01H)	'1'	-0.7
2 (02H)	'2'	-0.6
3 (03H)	'3'	-0.5
4 (04H)	'4'	-0.4
5 (05H)	'5'	-0.3
6 (06H)	'6'	-0.2
7 (07H)	'7'	-0.1
8 (08H)	'8'	0.0
9 (09H)	'9'	+0.1
10 (0AH)	'A'	+0.2
11 (0BH)	'B'	+0.3
12 (0CH)	'C'	+0.4
13 (0DH)	'D'	+0.5
14 (0EH)	'E'	+0.6
15 (0FH)	'F'	+0.7
16 to 127 (10H-7FH)	---	0.0

Exclusive ON/OFF

ASCII	Upper CH			Lower CH
'0'	OFF	OFF	OFF	OFF
'1'	OFF	OFF	OFF	ON
'2'	OFF	OFF	ON	OFF
'3'	OFF	OFF	ON	ON
'4'	OFF	ON	OFF	OFF
'5'	OFF	ON	OFF	ON
'6'	OFF	ON	ON	OFF
'7'	OFF	ON	ON	ON
'8'	ON	OFF	OFF	OFF
'9'	ON	OFF	OFF	ON
'A'	ON	OFF	ON	OFF
'B'	ON	OFF	ON	ON
'C'	ON	ON	OFF	OFF
'D'	ON	ON	OFF	ON
'E'	ON	ON	ON	OFF
'F'	ON	ON	ON	ON

MIDI Exclusive Format

Basic Format

The following table shows Matsushita's exclusive messages.

Format	Description	Remarks
F0H 54H fmt dat F7H	Exclusive status Matsushita's communication ID Format No. data (00H-7FH) End of exclusive	*1

* The following data structure and protocol are determined by format number.

Non-Procedure Basic Format

This format is used for transmission of relatively low volume of data.

Format	Description	Remark
F0H	Start of exclusive (start status)	
54H	Matsushita's ID code	
12H	Format No.	
SA	Station address	*1
UA	Unit address	*2
50H/53H	Polling/selecting message code	*3
CMD	Command	*4
DAT	Data	*5
03H/17H	End of text/end of text block	*6
BCC	Block check character	*7
F7H	End of exclusive (end status)	

*1: Station address (SA) is defined for individual model.

The station address of this equipment is "42H".

*2: Unit address (UA) is used for discriminating one device from another.

It is defined by a hex numeral between 20H and 2FH.

*3: "50H" for polling message, and "53H" for selecting message.

*4: Command (CMD) indicates the contents, format and size of this message. CMD and data structure are defined by "SA".

*5: Data size is not allowed to exceed 255 bytes. Data value is 20H to F7H. Data size and format are defined by "CMD" and "SA", respectively.

*6: Indicates the end of text or text block. The end of text is "03H"; the end of text block is "17H". When data size exceeds 255 bytes, each text block is suffixed with end of text block "17H".

*7: Block check character is a 2-byte ASCII code "0" to "9" or "A" to "F" (30H to 39H, 41H to 46H).

It is represented by exclusive OR (hex) of CMD through 03H/17H.

Basic Format of Handshake

Polling/Selecting Message Format [POL/SEL]

Format	Description	Remark
F0H	Start of exclusive (start status)	
54H	Matsushita's ID code	
11H	Format No.	
01H	Start of header	*1
SA	Station address	
UA	Unit address	
50H/53H	Polling/selecting message code	
F7H	End of exclusive	

*1: Start of header indicates the beginning of message. Also this message indicates polling or selecting message.

Text (Information message) Format [TEXT]

(1) Basic format

Format	Description	Remark
F0H	Start of exclusive	
54H	Matsushita's communication ID code	
11H	Format No.	
02H	Start of text	*1
CMD	Command	
DAT] Data	
03H	End of text	
BCC	Block check character	
DSZ	Data size	*2
F7H	End of exclusive	

(2) Multi-block

Format	Description	Remark
F0H	Start of exclusive	
54H	Matsushita's communication ID code	
11H	Format No.	
02H	Start of text	*1
DAT] Data	
17H	End of text	
BCC	Block check character	
DSZ	Data size	*2
F7H	End of exclusive	

*1: Start of text indicates that this message is a text message.

*2: Data size is a 2-byte ASCII code "0" to "9" or "A" to "F" (30H to 39H, 41H to 46H). It is represented by data count including CMD but not including "03H/17H".

■ Non-Procedure Message in Handshake Format

This message is used for memory change

Format	Description	Remark
F0H	Start of exclusive	
54H	Matsushita's communication ID code	
11H	Format No	
1BH	Escape sequence	*1
SA	Station address	
UA	Unit address	
MEM	Memory No	*2
F7H	End of exclusive	

*1 Escape sequence indicates that this message is a non-procedure message in the handshake format

*2 Memory number is a 2-byte ASCII code '0' to '9' or 'A' to 'F' (30H to 39H, 41H to 46H)

■ Data Transmission Control Procedure

Data control procedure consists of the following five control phases

Phase 1 Connect data transmission line

Phase 2 Establish data link

Phase 3 Send data

Phase 4 End of transmission

Phase 5 Disconnect the line

● Establishment of data link, data transmission, and termination

(1) Polling

The slave station sends a text message to the control station according to the polling procedure. Receiving the polling message (POL) with station address (SA) and unit address (UA) unique to the model, the slave station returns a response according to the following procedure

- Slave station without text to transmit

The control station sends a polling message (POL) to the slave station

The slave station sends an end of transmission message (EOT) to the control station

Example Control station Slave station
 [POL] →
 ← [EOT]

- Slave station with text to transmit

The control station sends a polling message (POL) to the slave station

The slave station sends the text

Receiving the text, the control station returns an acknowledgement message (ACK)

The slave station sends an end of transmission message (EOT)

Example Control station Slave station
 [POL] →
 ← [TXT]
 [ACK] →
 ← [EOT]

(2) Selecting

The slave station send a text message to the control station according to the selecting procedure. Receiving a selecting message (SEL) with station address (SA) and unit address (UA) unique to the model, the slave station returns a response according to the following procedure

- ① The control station sends a selecting message (SEL) to the slave station
- ② The slave station returns an acknowledgement message (ACK)
- ③ The control station sends TEXT
- ④ Receiving TEXT, the slave station returns an acknowledgement message (ACK)
- ⑤ If the slave station failed to receive the text properly, see (3), "Error Handling Procedure"
- ⑥ The control station sends an end of transmission message (EOT)

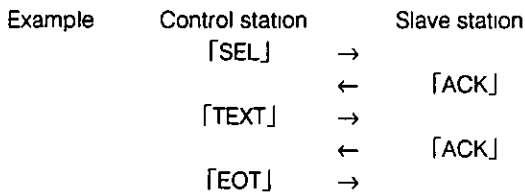

(3) Error Handling Procedure

- ① On receiving TEXT
 - If TEXT is received properly, the slave station returns an ACK
 - In the event of data range error, data size error, or BCC error, the slave station returns a not-acknowledgement (NAK)
- ② On receiving an ACK
The following message is sent
- ③ On receiving a NAK
The slave station resends the same message. If the control station received three NAKs for the same message, it sends an EOT and aborts communication

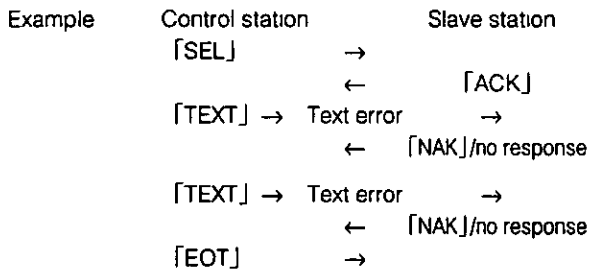

④ Time-out

The sender checks the time until a response is received from the receiver after message send. If no response is returned in 0.7 second, the sender resends the same message again.

If no response is returned from the slave station after the control station sends the same message three times, it sends an EOT and aborts communication with the slave station.

If no response is returned from the control station after the slave station sends the same message three times, the slave station aborts communication with the control station.

⑤ On receiving an illegal character

- If a received message contains an undefined character, the message is ignored
- If the received text contains data outside the specified range, a NAK is returned in handshake mode, and the text is ignored in one-way mode

⑥ On receiving an EOT

- On receiving an EOT, the data link is terminated, and the control station enters the next polling or selecting sequence
 - If an EOT reception error occurred, the control station retries the polling sequence
- The slave station ignores the error by terminating on EOT reception sequence time-out

MIDI Implementation Chart

Function	Transmission	Reception	Remarks
Basic Power ON Channel Setting disabled	1-16,OFF 1-16,OFF	1-16,OFF 1-16,OFF	Stored after powering OFF.
Mode Power ON Message Alternative	× × *****	OMNI ON/OFF	Stored after powering OFF.
Note number: Compass	× *****	× ×	
Velocity Note-On Note-Off	× ×	× ×	
After touch by key by channel	× ×	× ×	
Pitch bend	×	×	
Control change	6 ONRPN MSB data entry 38 ONRPN LSB data entry 98 ONRPN LSB register 99 ONRPN MSB register	ONRPN MSB data entry ONRPN LSB data entry ONRPN LSB register ONRPN MSB registe	Transmission is performed by panel operations when the SEND mode is [Bn] or [F0].
Program change: Range of setting	00-127 *****	00-127	
Exclusive	○	○	
: Song position	×	×	
Common: Song select : Tune	× ×	× ×	
Real Time : Clock : Command	× ×	× ×	
Others : Local ON/OFF : All note OFF : Active sensing : Reset	× × × ×	× × × ×	
Remarks			

Mode 1: Omni ON, Poly
Mode 3: Omni OFF, Poly

Mode 2: Omni ON, Mono
Mode 4: Omni OFF, Mono

○ : Yes
× : None

Modules Replacement

The module replacement procedure is shown in the following.

Precaution: Be sure to set the address after completing the Input or VCA Group module replacement.

■ Removing Modules

- (1) Remove four Meter Panel Fixing screws and raise up the meter panel.

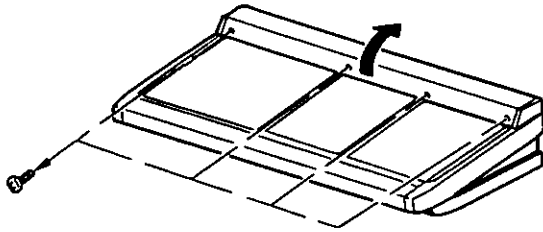

- (2) Remove four Ground Bar Fixing screws and raise up the Ground Bar mounting angle.

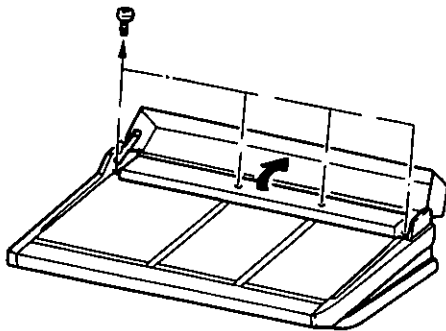

- (3) Secure Ground Bar Mounting Angle with two Ground Bar Fixing screws removed above.

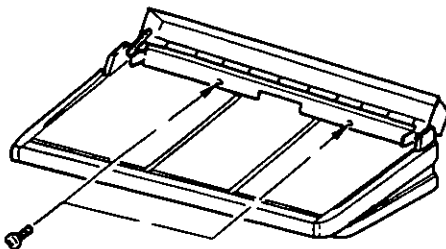

CAUTION

Be sure to firmly secure Ground Bar mounting angle.

Otherwise, the angle may fall down during module replacement and cause injury to the operator.

- Firmly secure the angle with two screws.

- (4) Remove the desired module from Channel Indication Plate.

The Channel Indication Plate can be divided into three modules by removing the Module Fixing Screws. Only desired module can be replaced.

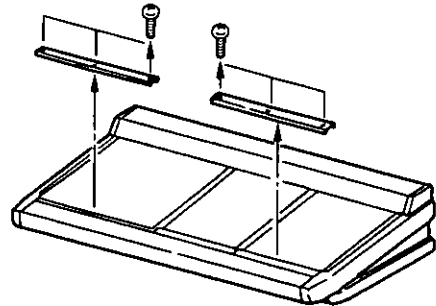

- (5) Open the front cover of the desired module.

Remove the Front Cover Fixing Screws of the desired module and open it. These Covers are also divided into three only desired module can be opened.

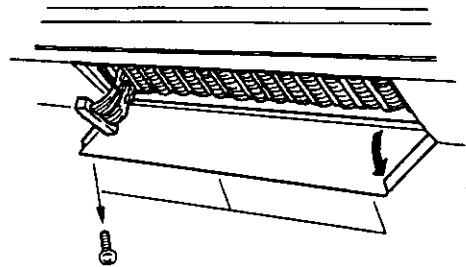

- (6) Release bus connector lock for the module to be replaced and disconnect flat bus cable.

Note: For the master module, also remove grounding lug.

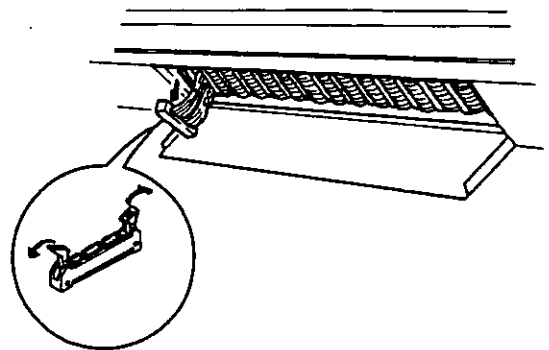

(7) Remove Grounding Lug from the Ground Bar on the module to be replaced.

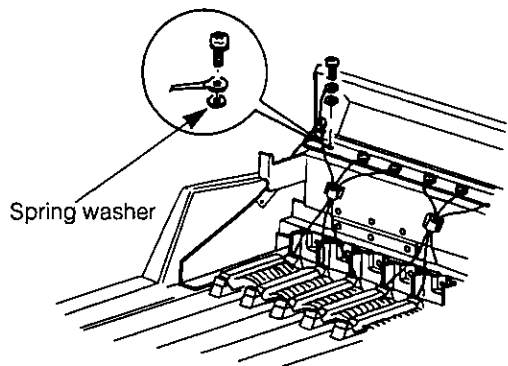

(8) Release the bus connector lock on each side and disconnect flat bus cable.

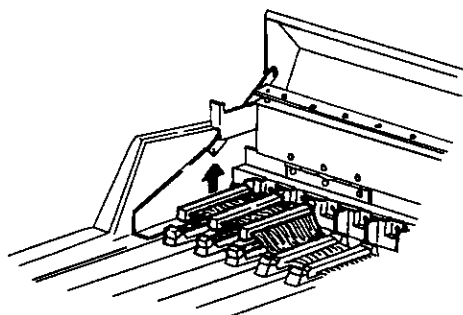

(9) Disconnect ground wire from the module to be replaced. (For Output module)

Note: For the master module, remove grounding lug.

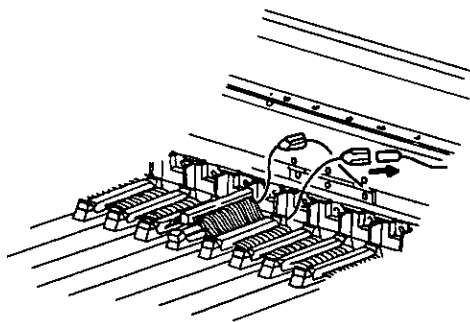

Master module

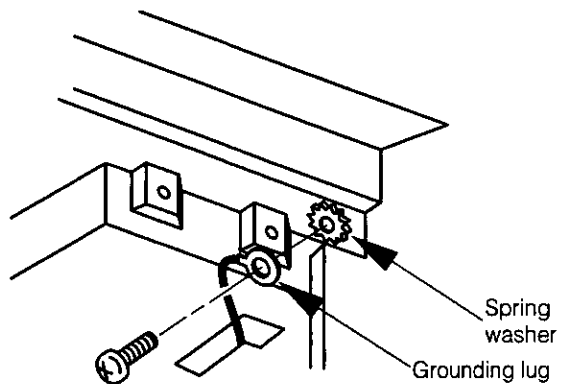

(10) Unscrew the Module Fixing Screws and remove module.

Take off three screws for an input module, five screws for VCA and six screws for master module.

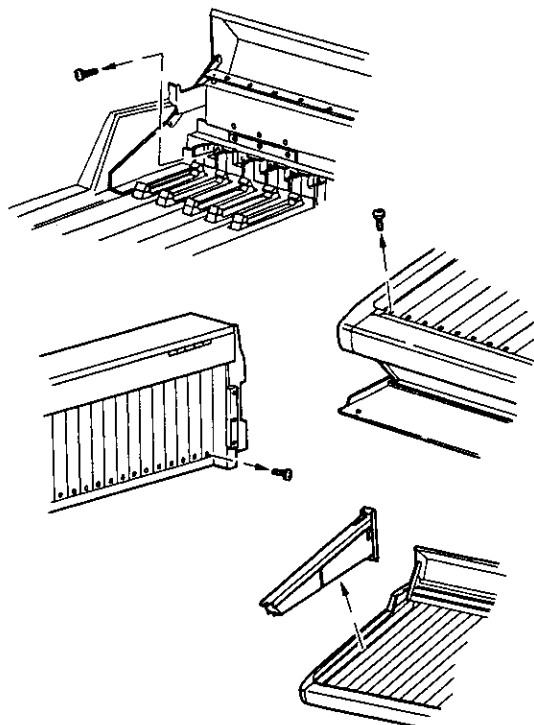

■ Installing Modules

(1) Mount the module onto the mixer.

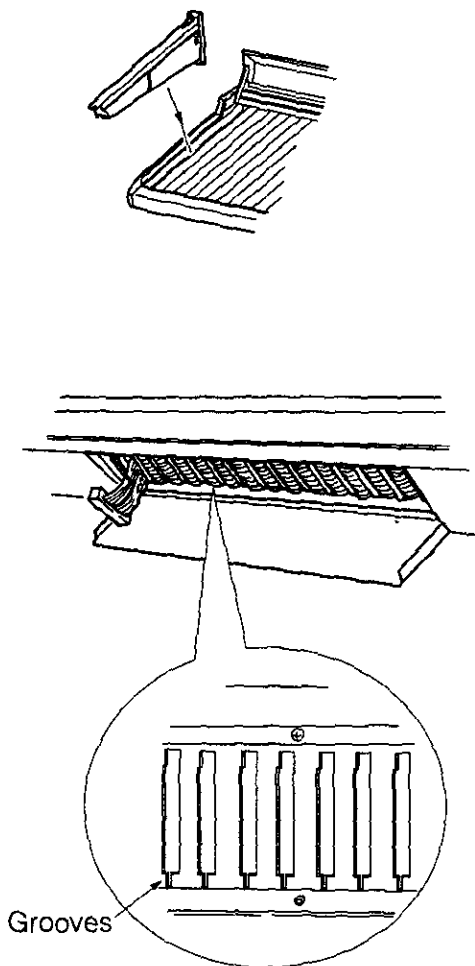

Note Modules should be installed into grooves firmly

(2) Secure the module into the groove with the module mounting screws; three screws for Input, five screws for VCA and six screws for Master modules.

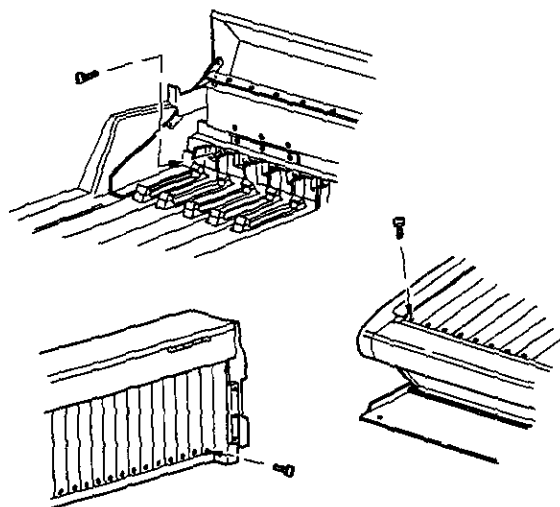

(3) Connect the Flat Bass Cable to the connector of this mixer as shown below.

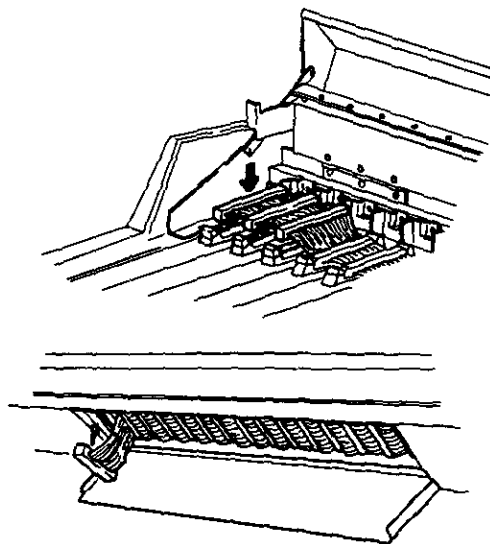

As for the Output Module, also make a connection of the Flat Bass Cable on the rear

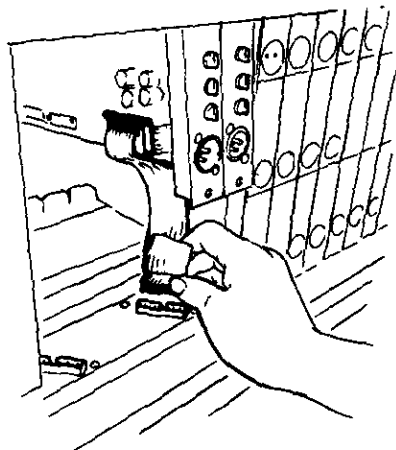

(4) Mount the ground wires and Grounding Lugs.

As for the Master Module, also mount the two Grounding Lugs inside the rear and front panels.
(Output module)

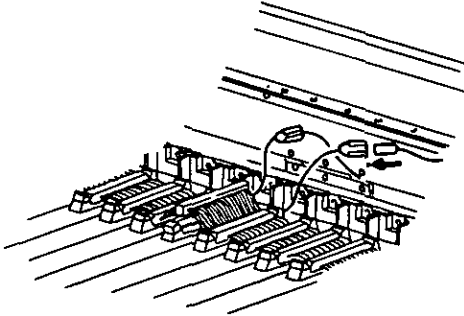

(Input module)

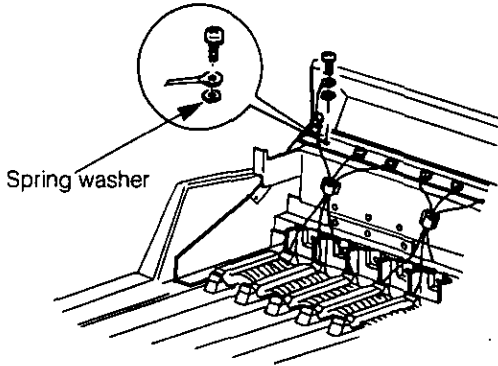

Spring washer

NOTES

Be sure to re-mount the spacer as shown below.

(5) Close the front cover and secure it with the screws.

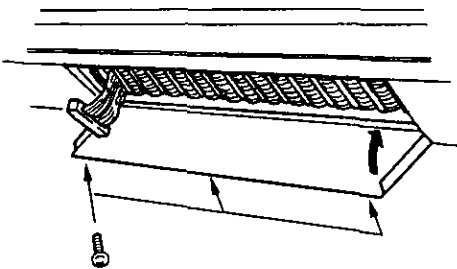

(6) Mount the Channel Indication Plate.

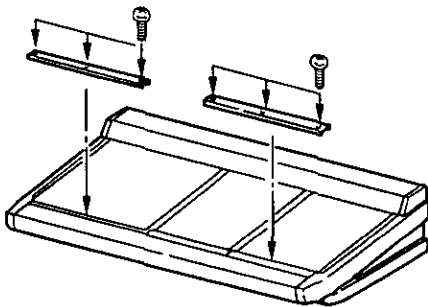

(7) Remove the two Ground Bar Mounting Angle Fixing Screws and return the Ground Bar Mounting Angle.

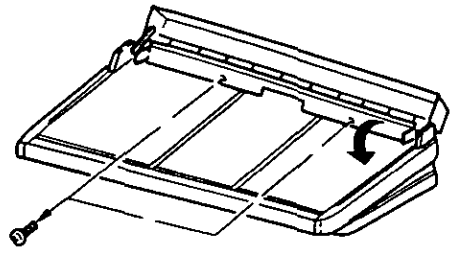

Caution: Be sure to return the Ground Bar Mounting Angle not to catch the wiring between the Ground Bar Mounting Angle and the Console Frame.

Good

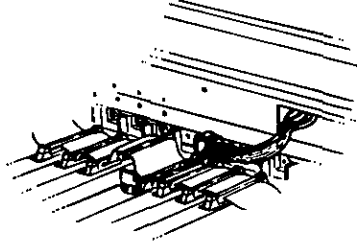

No Good

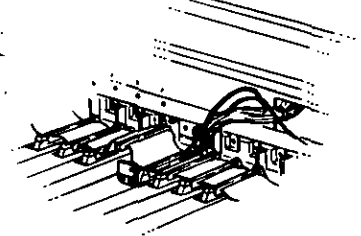

(8) Secure the Ground Bar Mounting Angle with the four Ground Bar Mounting Angle Fixing Screws.

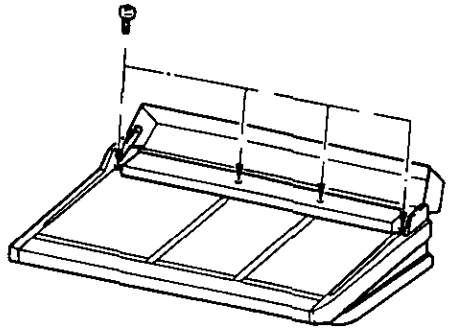

NOTES

Be sure to fix the Ground Bar Mounting Angle with the Ground Bar Mounting Angle Fixing screws. Otherwise, the inside of this mixer will be damaged.

(9) Return the Meter Panel and secure it with the four Meter Panel Fixing screws.

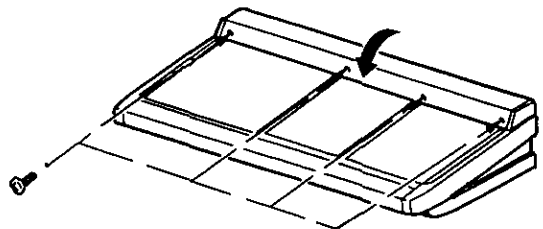

Address Setting

- Each module (channel) address is set as follows:
- Before replacing the module, be sure to set the address of that module. Incorrect address setting will damage computer control.
- When the front cover is open, a label can be viewed to indicate the address setting.

NOTE: Be sure to check the address setting according to the check program after completing the module replacement.

■ Monaural/Stereo Input Module (1CH to 52CH)

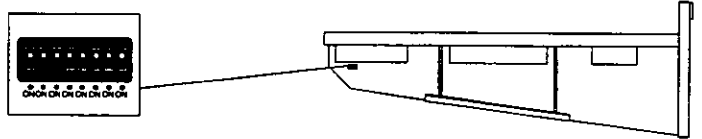

■ VCA Group Module

POSITION OF INTERNAL SWITCHES
 CPU ADDRESS SWITCHES
 VCA BUS SELECT SWITCHES
 AUX BUS SELECT SWITCHES

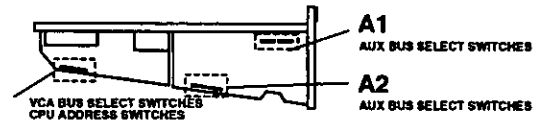

	VCA1	VCA2	VCA3	VCA4	VCA5
A1					
A2					
B					

	VCA6	VCA7	VCA8	VCA9	VCA10
A1					
A2					
B					

Internal Switch Setting

■ Monaural Input Module

● Switch Layout Drawing

Intermediate board

Switch No.	Function	Contents of selection
SW21	AUX 19, 20 Mode selection	<input type="radio"/> LEVEL / LEVEL <input type="checkbox"/> LEVEL / PAN
SW22	AUX 17, 18 Mode selection	<input type="radio"/> LEVEL / LEVEL <input type="checkbox"/> LEVEL / PAN
SW23	AUX 15, 16 Mode selection	<input type="radio"/> LEVEL / LEVEL <input type="checkbox"/> LEVEL / PAN
SW24	AUX 13, 14 Mode selection	<input type="radio"/> LEVEL / LEVEL <input type="checkbox"/> LEVEL / PAN

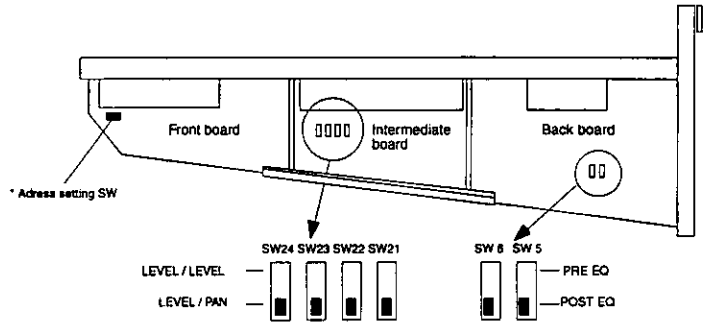

Back Board

Switch No.	Function	Contents of selection
SW 5	AUX 1-12 PRE Mode selection	<input type="radio"/> PRE EQ <input type="checkbox"/> POST EQ
SW 6	AUX 13-20 PRE Mode selection	<input type="radio"/> PRE EQ <input type="checkbox"/> POST EQ

■ Stereo Input Module

● Switch Layout Drawing

Intermediate board

Switch No.	Function	Contents of selection
SW21	AUX 1-4(PRE) Mode selection	<input type="radio"/> STEREO <input type="checkbox"/> MONO
SW22	AUX 5-8(PRE) Mode selection	<input type="radio"/> STEREO <input type="checkbox"/> MONO
SW23	AUX 9-12(PRE) Mode selection	<input type="radio"/> STEREO <input type="checkbox"/> MONO
SW24	AUX13-16(PRE) Mode selection	<input type="checkbox"/> STEREO <input type="radio"/> MONO
SW25	AUX17-20(PRE) Mode selection	<input type="checkbox"/> STEREO <input type="radio"/> MONO
SW26	AUX 1-4(POST) Mode selection	<input type="radio"/> STEREO <input type="checkbox"/> MONO
SW27	AUX 5-8(POST) Mode selection	<input type="radio"/> STEREO <input type="checkbox"/> MONO
SW28	AUX 9-12(POST) Mode selection	<input type="radio"/> STEREO <input type="checkbox"/> MONO
SW29	AUX13-16(POST) Mode selection	<input type="checkbox"/> STEREO <input type="radio"/> MONO
SW30	AUX17-20(POST) Mode selection	<input type="checkbox"/> STEREO <input type="radio"/> MONO

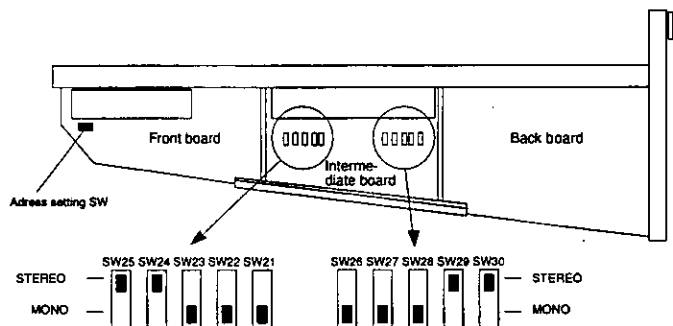

■ VCA Group Module

● Switch Layout Drawing

Intermediate board

Switch No.	Function	Contents of selection
SW 3	Odd-number AUX PFL/AFL Selection	<input type="radio"/> POST <input checked="" type="radio"/> PRE
SW 6	Even-number AUX PFL/AFL Selection	<input type="radio"/> POST <input checked="" type="radio"/> PRE

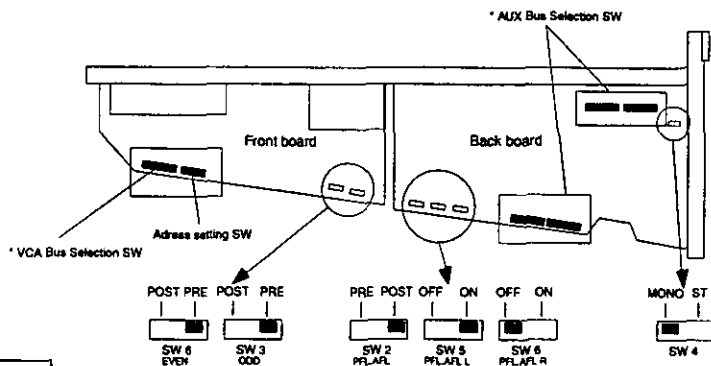

Back Board

Switch No.	Function	Contents of selection	
SW 2	MATRIX PFL/AFL Selection	<input type="radio"/> PRE <input checked="" type="radio"/> POST	
*1 SW 4	AUX PFL/AFL MONO,ST Selection	AUX 1-12	<input type="radio"/> MONO <input checked="" type="radio"/> STEREO
		AUX 13-20	<input type="radio"/> MONO <input checked="" type="radio"/> STEREO
*2 SW 5	MATRIX PFL/AFL L Transmit	Odd Number MATRIX	<input type="radio"/> OFF <input checked="" type="radio"/> ON
		Even number MATRIX	<input type="radio"/> OFF <input checked="" type="radio"/> ON
*2 SW 6	MATRIX PFL/AFL R Transmit	Odd Number MATRIX	<input type="radio"/> OFF <input checked="" type="radio"/> ON
		Even number MATRIX	<input type="radio"/> OFF <input checked="" type="radio"/> ON

*1 SW4 initialization varies with AUX number as shown in the above table.

*2 SW5 and SW6 initializations vary depending on whether the MATRIX number is an even number or an odd number, as shown in the above table.

■ Master Module

(1) Master PCB Section

● Switch Layout Drawing

Front board

Switch No.	Function	Contents of selection
SW 2	PFL/AFL Selection	<input type="radio"/> PRE <input checked="" type="radio"/> POST
SW 4	SUB OUT PRE/POST Selection	<input type="radio"/> POST <input checked="" type="radio"/> PRE

Back Board

Switch No.	Function	Contents of selection
SW 2	REC OUT PRE/POST Selection	<input type="radio"/> PRE <input checked="" type="radio"/> POST

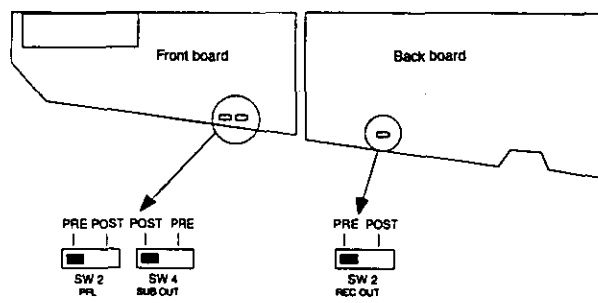

(2) CPU Master PCB Section

● Switch Layout Drawing

Switch No	Function	Contents of selection
*1 SW 102	CPU ENABLE/DISABLE Selection	<ul style="list-style-type: none"> ● DIS ● EN
*2 SW 103	MASTER/SLAVE Selection	<ul style="list-style-type: none"> ● MAS ● SLV

- * 1 SW102 can be operated externally by removing MIDI connector panel from the back
- * 2 Since SW103 is provided on the back panel, it can be operated externally
- * 3 Refer to page 39 for setting the operation mode of SW101

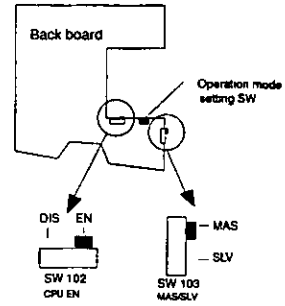

(3) TB/OSC/Monitor PCB Section

● Switch Layout Drawing

Front board

Switch No	Function	Contents of selection
SW 7	*1 Monitor system setting	<ul style="list-style-type: none"> ● MONI ● MONI/PFL · AFL

Back Board

Switch No	Function	Contents of selection
SW 17	TB microphone +48V ON/OFF switching	<ul style="list-style-type: none"> ● OFF ● ON (+48V)

- * 1 The monitor system setting is to select whether or not the interruption of signals to the monitor output is allowed. The initial setting allows the interruption.

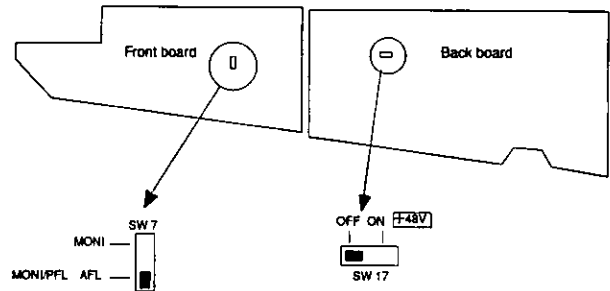

Connector Information

■ XLR Type Connector

● Balanced connection (input)

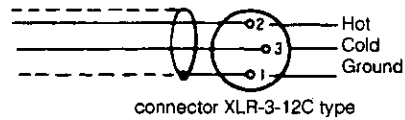
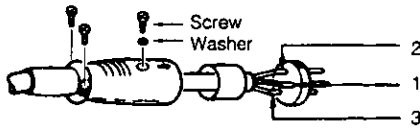

● Balanced connection (output)

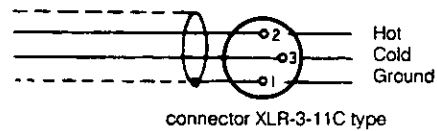
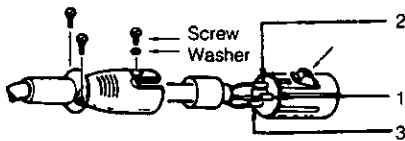

● Unbalanced connection (Input/Output)

Connect pin No. 2 to HOT and pin numbers 1 and 3 to GROUND.

- Do not use Phantom power supply when the unbalanced microphone and peripheral equipment are used as the input.
- Keep the length of connection less than 10 m. If the connection length exceeds 10 m, use a transformer for balance conversion before making the connection.

For a long connecting cable, the use of a 4-core quad stranded cable, such as 4E6, is recommended because of its high resistivity to induced noise.

For wiring, connect a blue and blue cable to the HOT terminal, a white and white cable to the COLD terminal, and a shielded cable to the GROUND terminal.

■ Duplex Plug (Input/Output)

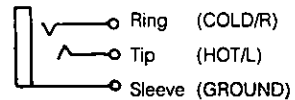
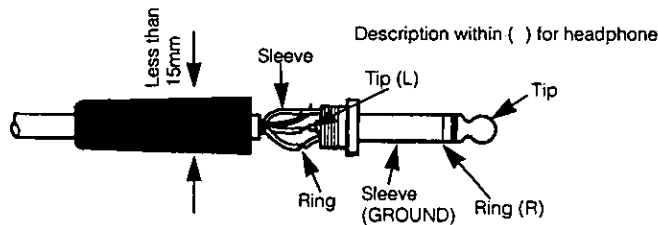

Note

Make sure to use the grip less than 15mm in diameter.
Otherwise it causes defective contact by touching those grips.

■ RCA Pin Plug (Input)

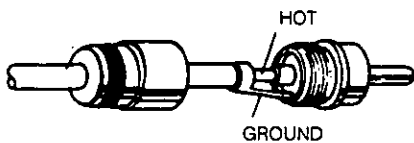

■ D-sub Connector

● External control terminal

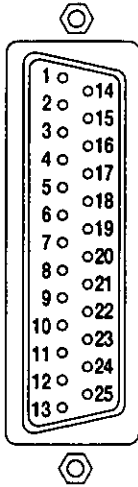

Pin Layout Table

Pin No.	Contents
1	VCA Group 1 External Control
2	VCA Group 2 External Control
3	VCA Group 3 External Control
4	VCA Group 4 External Control
5	VCA Group 5 External Control
6	VCA Group 6 External Control
7	VCA Group 7 External Control
8	VCA Group 8 External Control
9	VCA Group 9 External Control
10	VCA Group 10 External Control
11	ADVANCE SW
12~25	GND

● D-sub connector wiring method

When this unit is operated in the cascade connection mode, this switch is used to set the master and slave sides.

MASTER : The VCA group on MASTER side is valid. The voltage, controlled with the MASTER-console VCA-group fader and VCA ON switch, is output to the D-SUB 25-pin VCA remote terminal.

SLAVE : The SLAVE-side VCA-group fader and VCA ON switch are invalidated. The slave-side VCA-group assignment data is valid. VCA-group level control is provided by the voltage input to D-SUB 25-pin VCA remote terminal.

(1) Cascade Connection

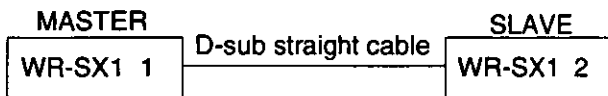

VCA group control level of SLAVE can be controlled by VCA group of MASTER.

Note: In the above connection, the ADVANCE function can not be cascated.

BY connecting the MIDI OUT of MASTER to the MIDI IN of SLAVE, it's fuction can be activated.

(2) External Control

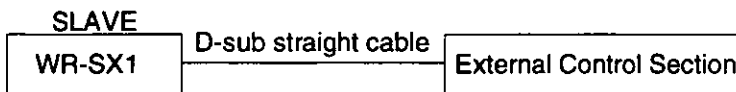

VCA group control level can be controled by the External Control level.

Refer to the qualified personnel for the same control with VCA group.

Block Diagram

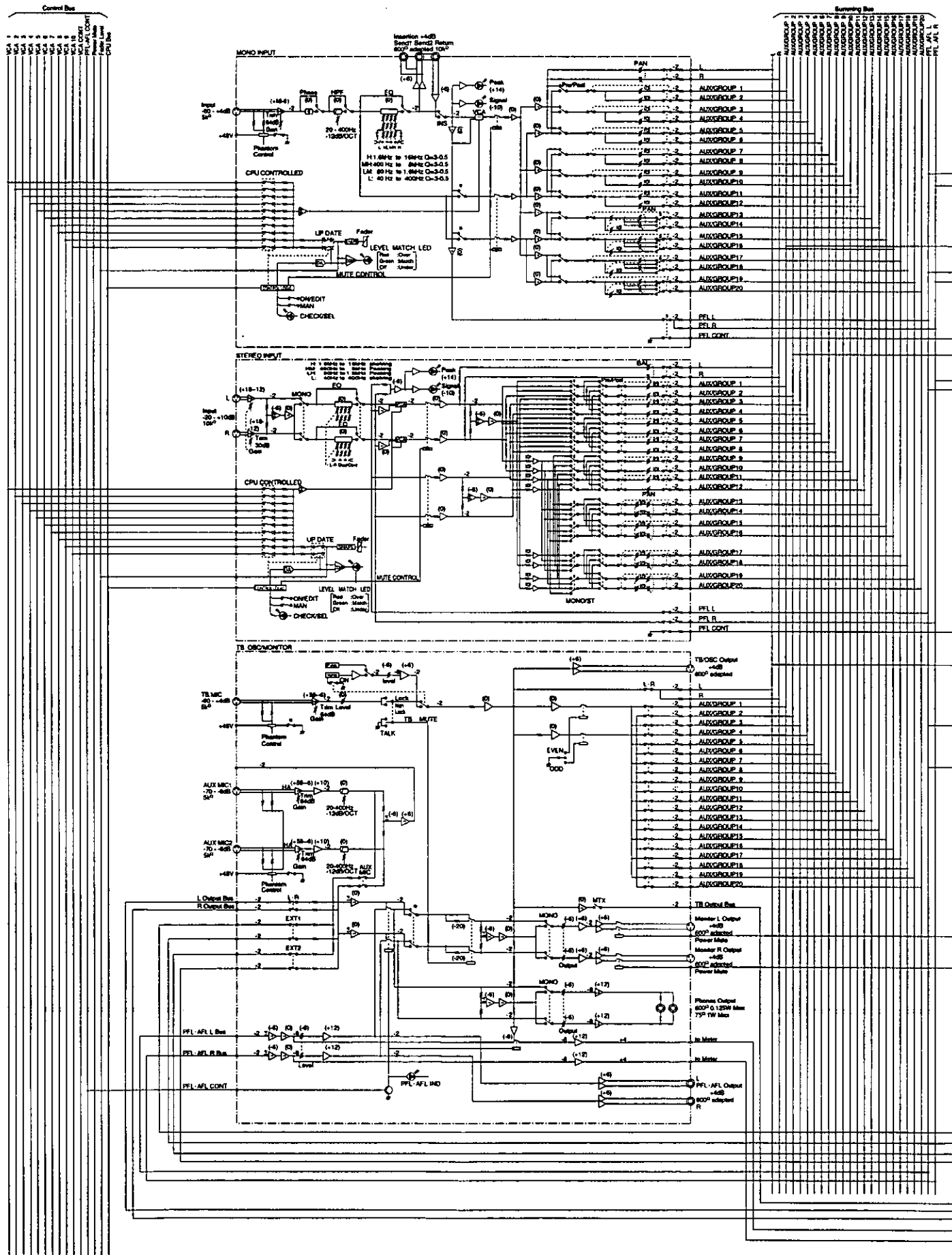

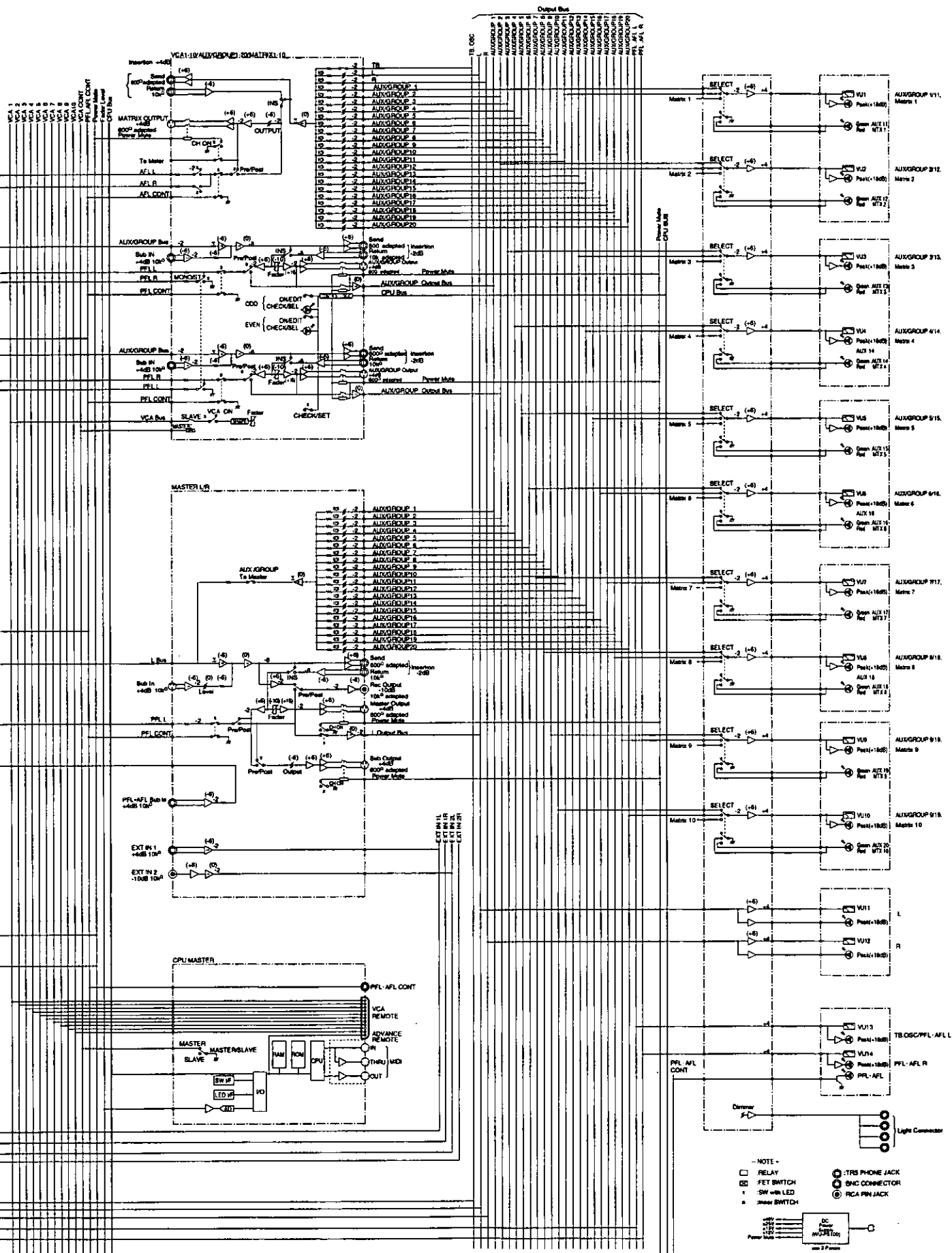

- NOTE -
- RELAY
 - ⊞ FET SWITCH
 - ⊞ SW with LED
 - Jumper SWITCH
 - ⊙ TRS PHONE JACK
 - ⊙ BNC CONNECTOR
 - ⊙ RCA PIN JACK

Level Diagram

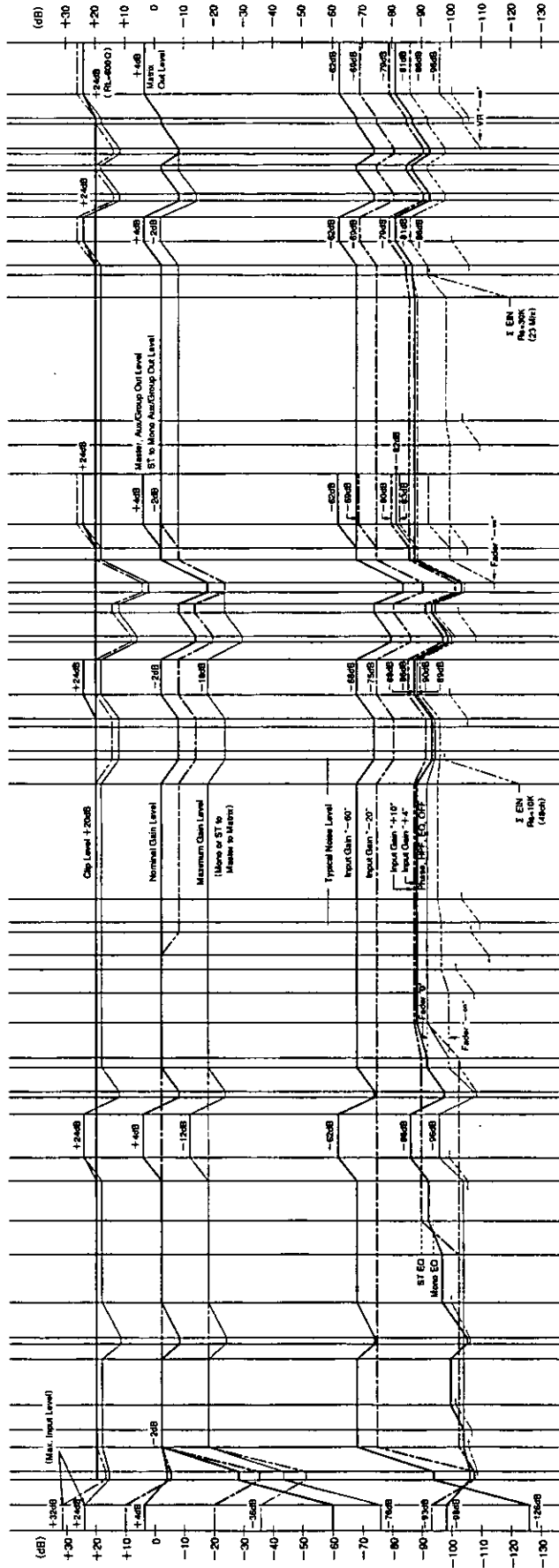
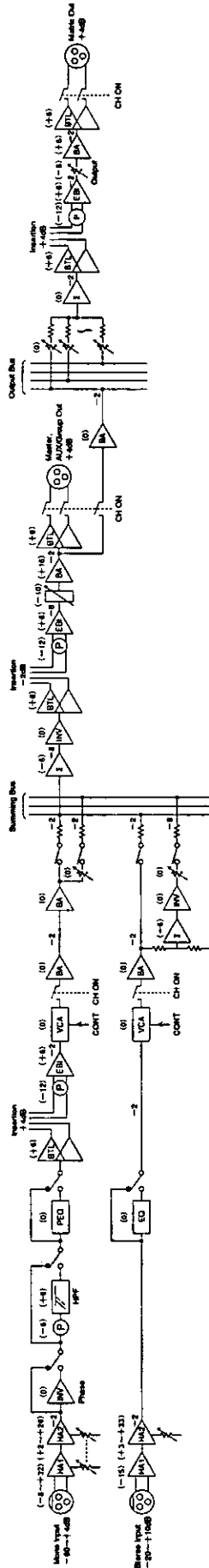

————— from Mono Input - - - - - from Stereo Input - - - - - Fader, Output VR "∞"

Characteristics Table

● Frequency Response

Mono-Input to Master-out

(1): Input gain +4 setting

(2): Input gain -60 setting

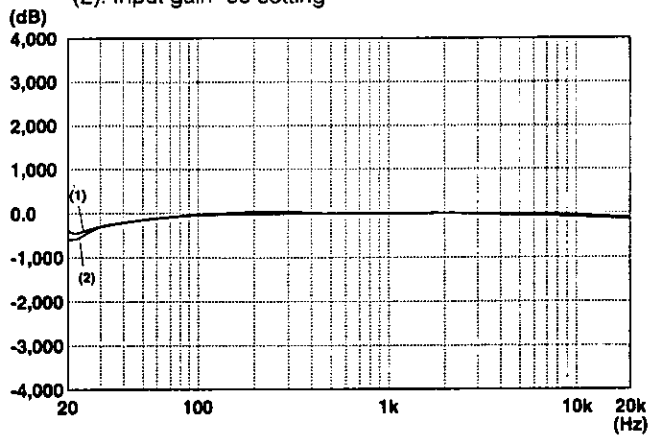

Stereo-Input to Master-out

(1): Input gain +10 setting

(2): Input gain -20 setting

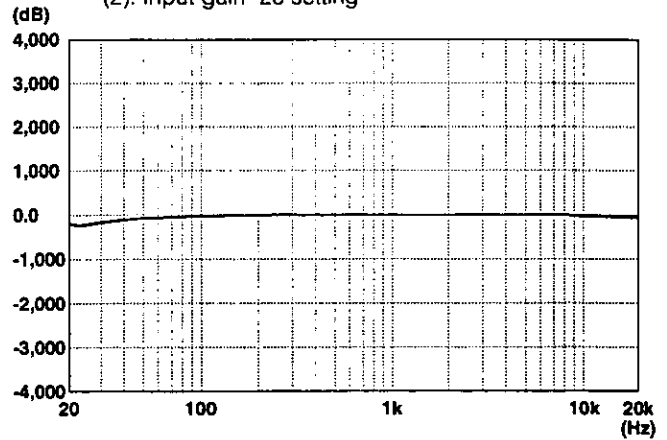

● Frequency to Total Harmonic Distortion Ratio

Mono, stereo-Input to Master-out, Input gain +4 or +10, Output fader +10, Load 600 ohms

+14dB output

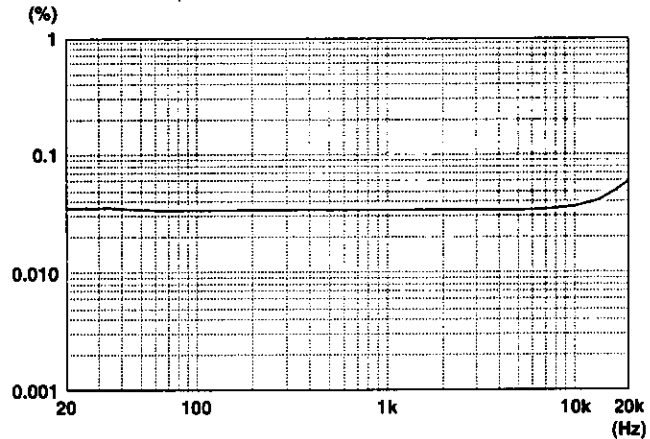

+24dB output

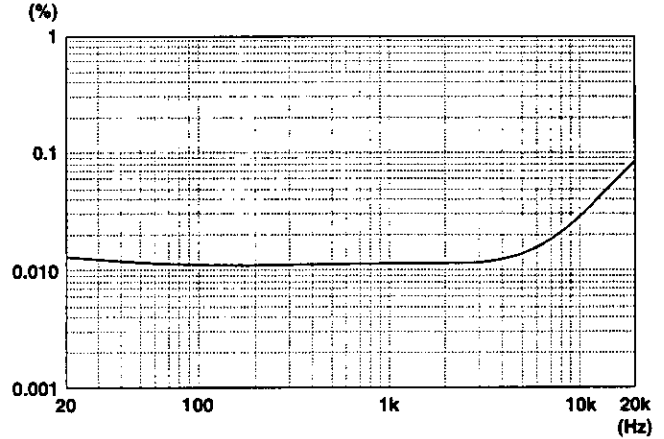

● Crosstalk

With the fader turned down

(1): Input or VCA group fader

(2): AUX/Group or Master fader

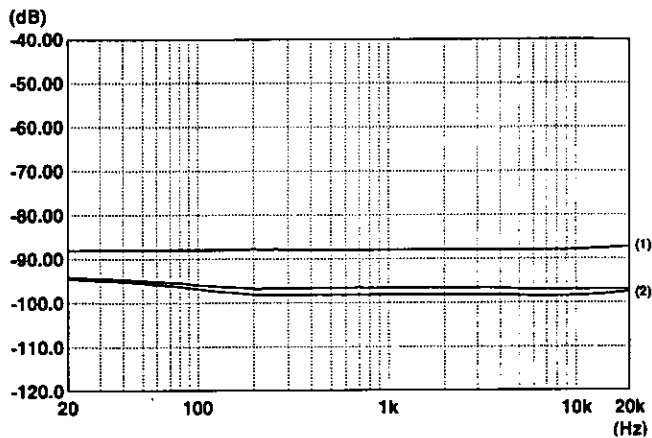

ASSIGN Switch OFF

(1): Master ASSIGN switch

(2): AUX/Group ASSIGN switch

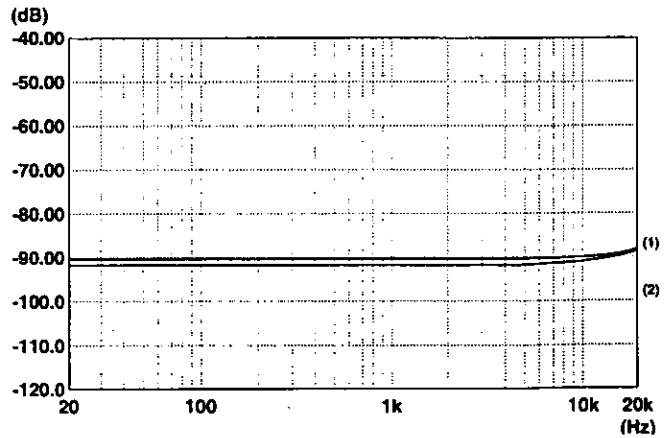

● Parametric Equalizer

HIGH (Shelving) $\pm 15\text{dB}$, 1.6kHz to 16kHz

LOW (Shelving) $\pm 15\text{dB}$, 40Hz to 400Hz

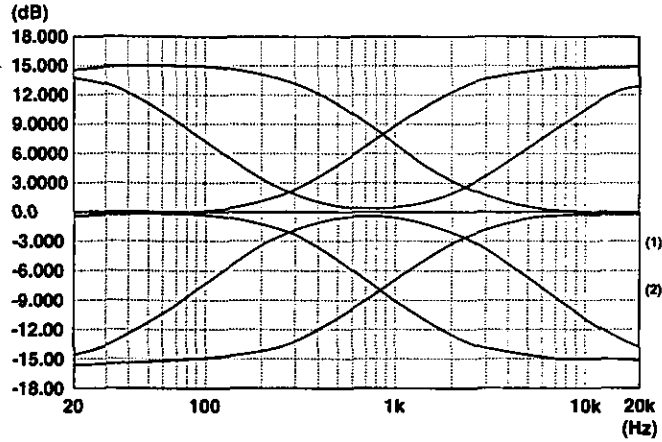

HIGH (peaking) $\pm 15\text{dB}$, 1.6kHz to 16kHz
Q=3 to 0.5

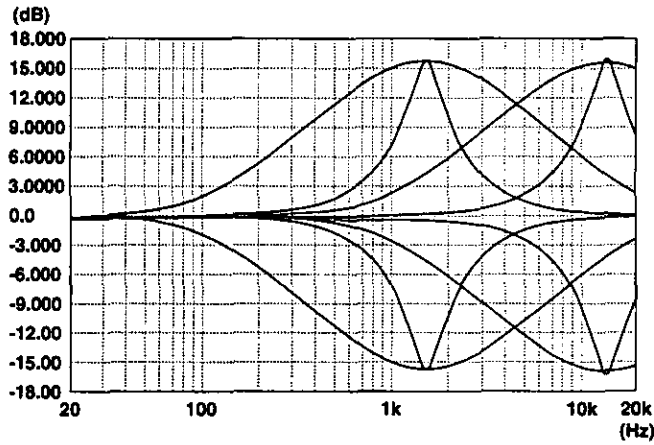

HIGH MID (peaking) $\pm 15\text{dB}$, 400Hz to 8kHz
Q=3 to 0.5

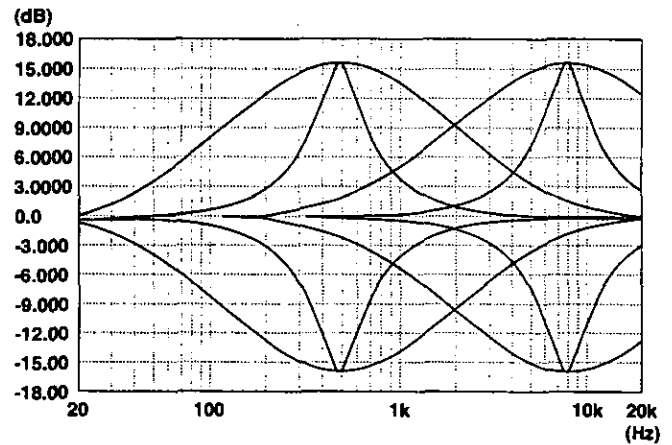

LOW MID (peaking) $\pm 15\text{dB}$, 1.6kHz to 16kHz
Q=3 to 0.5

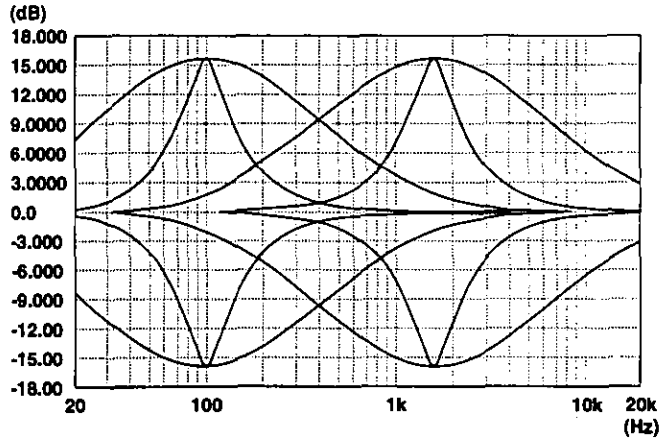

LOW (peaking) $\pm 15\text{dB}$, 40Hz to 400Hz
Q=3 to 0.5

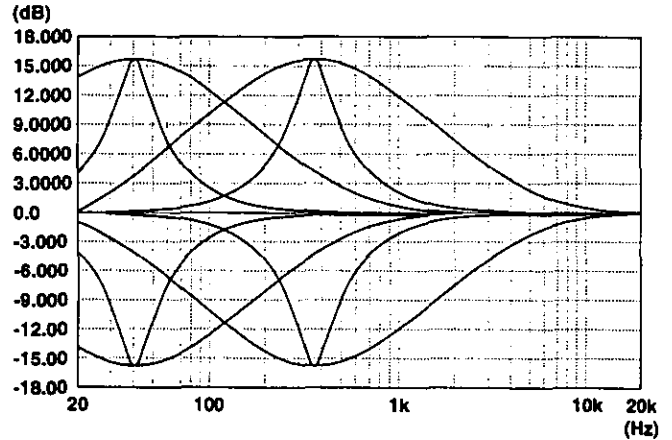

Specifications

Power voltage:	Provided from the power supply unit WU-PS100 (12 VDC, $\pm 15V$, $\pm 25V$, +48V)
Power consumption:	approx. 800W (With approx. 48CH model at a load impedance of 600 ohms and a total input/output of +14dB)
Frequency characteristics:	+0/-1.0dB, 20Hz to 20kHz (Monaural/Stereo Input to AUX/Group/Master Out, loaded impedance 600 ohms)
Total harmonics distortion:	0.1% or less, 20Hz to 20kHz Monaural/Stereo Input to AUX/Group/Master Out Input gain "+4" or "+10", Output fader "+10", loaded impedance 600 ohms at +14dB
Input converted noise (monaural input):	-126dB or less (Source impedance 150 ohms, Input gain "-60", Audio band 22.4Hz to 22.4 kHz)
Cross talk:	:-70dB or less, 1 kHz (channel switch, min. channel fader level) :-60dB or less, 10 kHz (channel switch, min. channel fader level) :-80dB or less, 1 kHz (between adjacent input channels) :-70dB or less, 10 kHz (between adjacent input channels)
Common-mode rejection ratio:	:Monaural input: 75dB or more, 1 kHz (Monaural input, Input gain "-60") :Stereo input: 40dB or more, 1 kHz (Stereo input, Input gain "-20")
Max. voltage gain:	:Monaural input to AUX/Group/MASTER Out: 84dB, 1 kHz :Stereo input to AUX/Group/MASTER Out: 44dB, 1 kHz (Loaded impedance 600 ohms)
Max. input level:	:Monaural input: +24dB, 20Hz to 20kHz (Monaural input, Input gain "+4") :Stereo input: +32dB, 20Hz to 20kHz (Stereo input, Input gain "+10") (THD 0.2% or less)
Max. output level (balanced output):	+24dB, 20Hz to 20kHz (loaded impedance 600 ohms, THD 0.2% or less)
Residual noise:	-92dB or less (Output fader or control "-∞", loaded impedance 600 ohms, Audio band 22.4Hz to 22.4kHz)
Equalizer:	:Monaural input (Q variable, Q = 3 to 0.5) HIGH ± 15 dB peaking/shelving 1.6kHz to 16kHz MID HIGH ± 15 dB peaking 400Hz to 8kHz MID LOW ± 15 dB peaking 80Hz to 1.6kHz LOW ± 15 dB peaking/shelving 40Hz to 400Hz :Stereo input HIGH ± 15 dB shelving 1.6kHz to 16kHz MID HIGH ± 15 dB peaking 400Hz to 8kHz MID LOW ± 15 dB peaking 80Hz to 1.6kHz LOW ± 15 dB shelving 40Hz to 400Hz
High Pass Filter:	-12dB/Oct 20Hz to 400Hz
Meter:	VU meter x 14 AUX/GROUP/MATRIX x 10, Master x 2, TB.OSC/PFL-AFL x 2
Operating temperature:	0 °C to +40 °C
Dimensions:	WR-SX1A/32; 1,718 (W) x 346 (H) x 1,030 (D) mm WR-SX1A/40; 1,966 (W) x 346 (H) x 1,030 (D) mm WR-SX1A/48; 2,214 (W) x 346 (H) x 1,030 (D) mm
Weight:	WR-SX1A/32; Approx. 148 kg WR-SX1A/40; Approx. 168 kg WR-SX1A/48; Approx. 185 kg

● Input

Name	Connector	Rated Level	Input Impedance
Monaural input	XLR3-31 or equivalent (balanced)	-60 to +4dB	5 k ohms
Stereo input	XLR3-31 or equivalent (balanced)	-20 to +10dB	10 k ohms
Monaural input insertion return	Duplex jack (balanced)	+4dB	10 k ohms
MATRIX insertion return	Duplex jack (balanced)	+4dB	10 k ohms
AUX/Group, Master insertion return	Duplex jack (balanced)	-2dB	10 k ohms
AUX/Group SUB IN	Duplex jack (balanced)	+4dB	10 k ohms
Master SUB IN	XLR3-31 or equivalent (balanced)	+4dB	10 k ohms
PFL/AFL SUB IN	Duplex jack (balanced)	+4dB	10 k ohms
Monitor EXT IN 1	Duplex jack (balanced)	+4dB	10 k ohms
Monitor EXT IN 2	RCA pin jack (unbalanced)	-10dB	10 k ohms
TB MIC input	XLR3-31 or equivalent (balanced)	-60 to +4dB	5 k ohms
AUX MIC input	XLR3-31 or equivalent (balanced)	-70 to -6dB	5 k ohms

● Output

Name	Connector	Rated Level	Input Impedance
AUX/Group, Master, Master SUB OUT, Monitor, Matrix, TB/OSC	XLR3-32 or equivalent (balanced)	+4dB	600 ohms or more
Monaural input insertion send 1,2	Duplex jack (balanced)	+4dB	600 ohms or more
MATRIX insertion send	Duplex jack (balanced)	+4dB	600 ohms or more
AUX/Group, Master insertion send	Duplex jack (balanced)	-2dB	600 ohms or more
Master REC OUT	RCA pin jack (unbalanced)	-10dB	10 k ohms or more
PFL/AFL OUT	Duplex jack (balanced)	+4dB	600 ohms or more
Headphone OUT	Duplex jack (stereo)	75 ohms 1 W max. 600 ohms 125 mW max.	75 to 600 ohms or more (in use of single output only)

■ Accessory

Fader ganging.....10 pcs.

Appearance

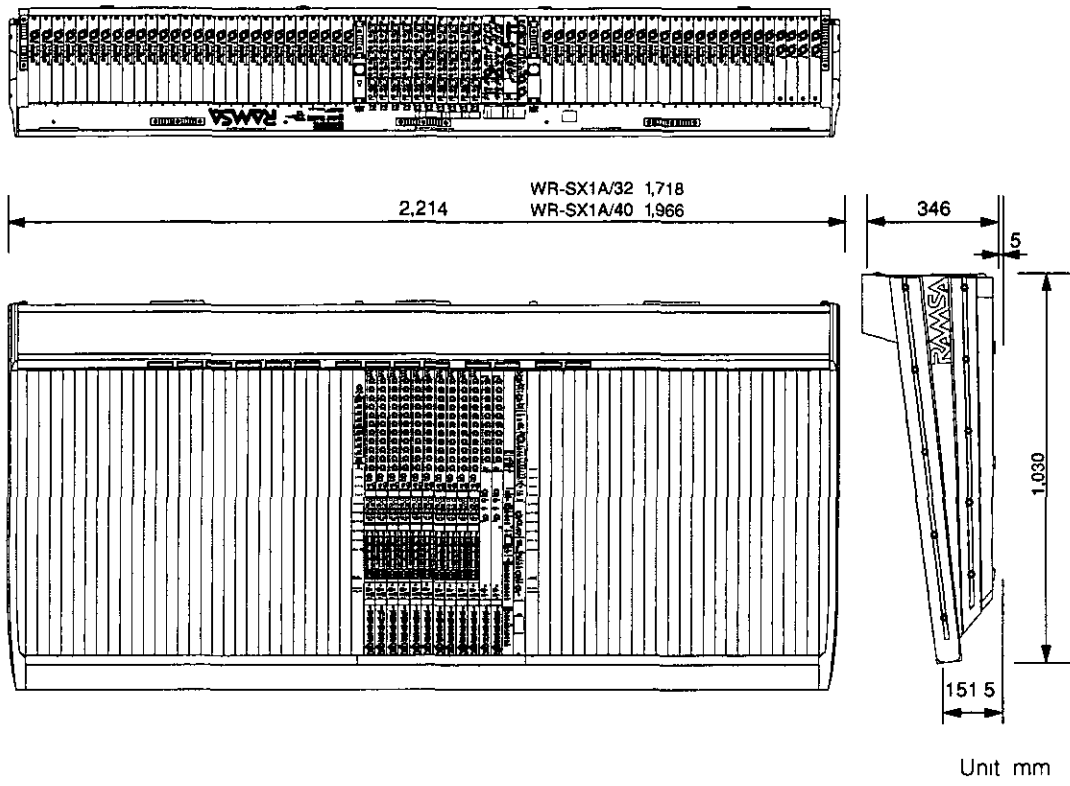

Troubleshooting Flowchart

Either one of power indicators on the mixer fails to light.

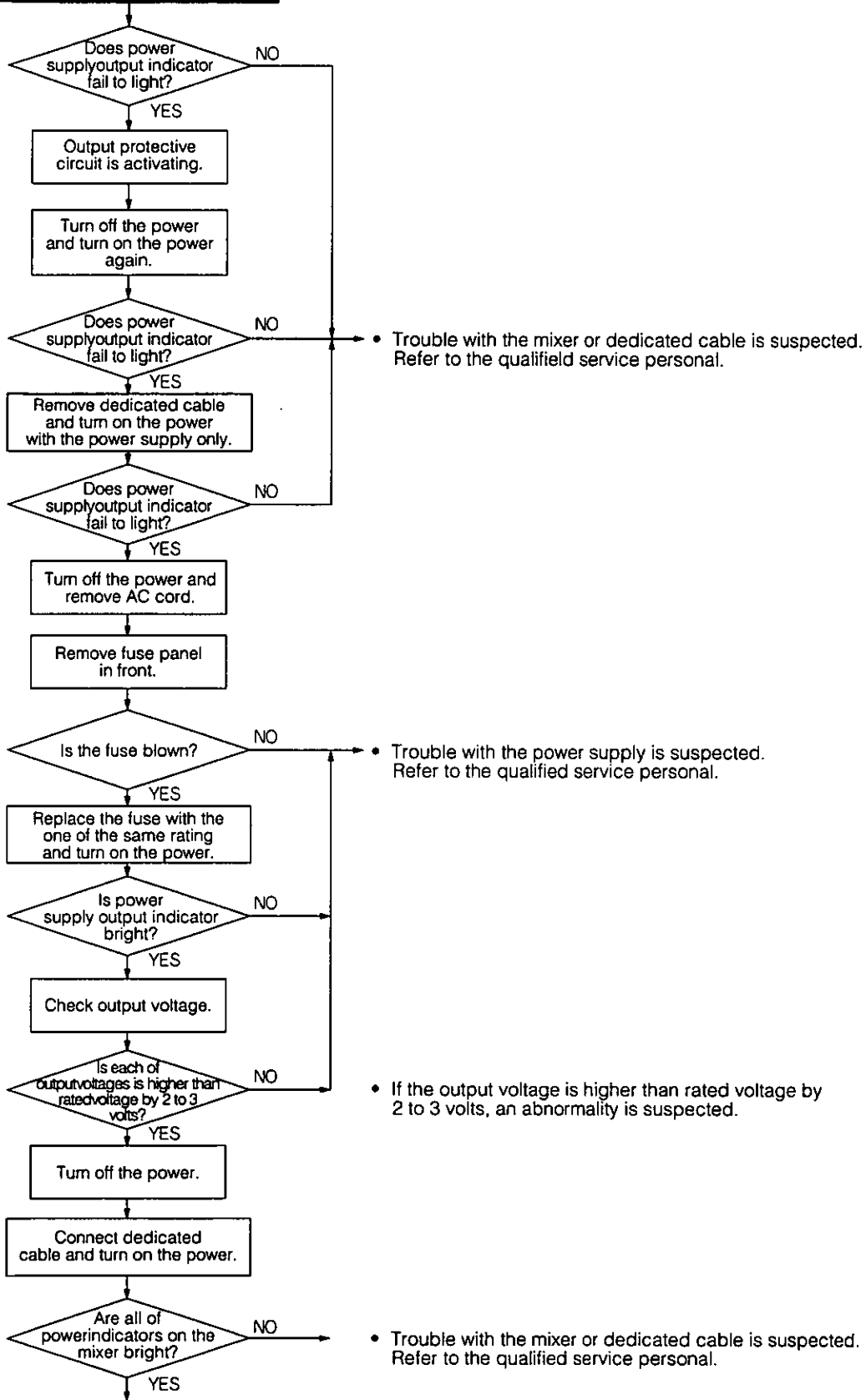

If no particular trouble is found, go ahead to use it.

• The cause of blown fuse may be some external factors such as a fluctuation of power supply voltage (Power switch ON/OFF). The replacement of a module while the power is ON can also be a cause of blown fuse.

Before Calling for Service

Symptom	Possible cause
No power input	<ul style="list-style-type: none"> • Power cord is unplugged from the wall outlet. • The cable that connects the equipment to power supply is not connected properly.
No sound output	<ul style="list-style-type: none"> • Either of the two power supplies is not connected properly. • The fader for the assigned VCA group is set minimum. • The output is muted with mute group.
Nothing is displayed on the 7-segment display.	<ul style="list-style-type: none"> • The switch on the CPU back board is set at "DIS".
Write or edit operation is ineffective.	<ul style="list-style-type: none"> • Lock switch is activating.
Memory read is not properly performed.	<ul style="list-style-type: none"> • While fader level can always be read, other data can be enabled or disabled for read with switches on the CPU back board. Check if the desired data is enabled for read.
Fader level does not match the actual level:	<ul style="list-style-type: none"> • Check if the UPDATE switch on the input module is pressed. If it is pressed, the actual level is the sum of fader level and the level set by the CPU. • Assigned to a VCA group.
VCA group fader is not effective.	<ul style="list-style-type: none"> • The MASTER/SLAVE switch on the back board is set at "SLAVE."
Uncontrollable with MIDI.	<ul style="list-style-type: none"> • MIDI cable connection is incomplete. • MIDI channel setting is not correct.

Panasonic

Broadcast & Television Systems Company

Division of Matsushita Electric Corporation Of America
RAMSA/Professional Audio Systems

Executive Office One Panasonic Way, Secaucus, New Jersey 07094
6550 Katella Ave 17A-7, Cypress, CA 90630 (714) 373-7277

MATSUSHITA ELECTRIC OF CANADA LIMITED
5770 Ambler Drive, Mississauga, Ontario, L4W 2T3 Canada (905) 624-5010
PANASONIC SALES COMPANY

DIVISION OF MATSUSHITA ELECTRIC OF PUERTO RICO, INC.
San Gabriel Industrial Park, 65th Infantry Ave, K M 9.5 Carolina, Puerto Rico 00630 (809) 750-4300

B1096-0 YWA8QA4437AN