

AV Control Stereo Receiver

SA-DX930 **SA-DX830**

Operating Instructions



The photographs show SA-DX930.
The SA-DX830 model is only for Canada.

Technics[®]

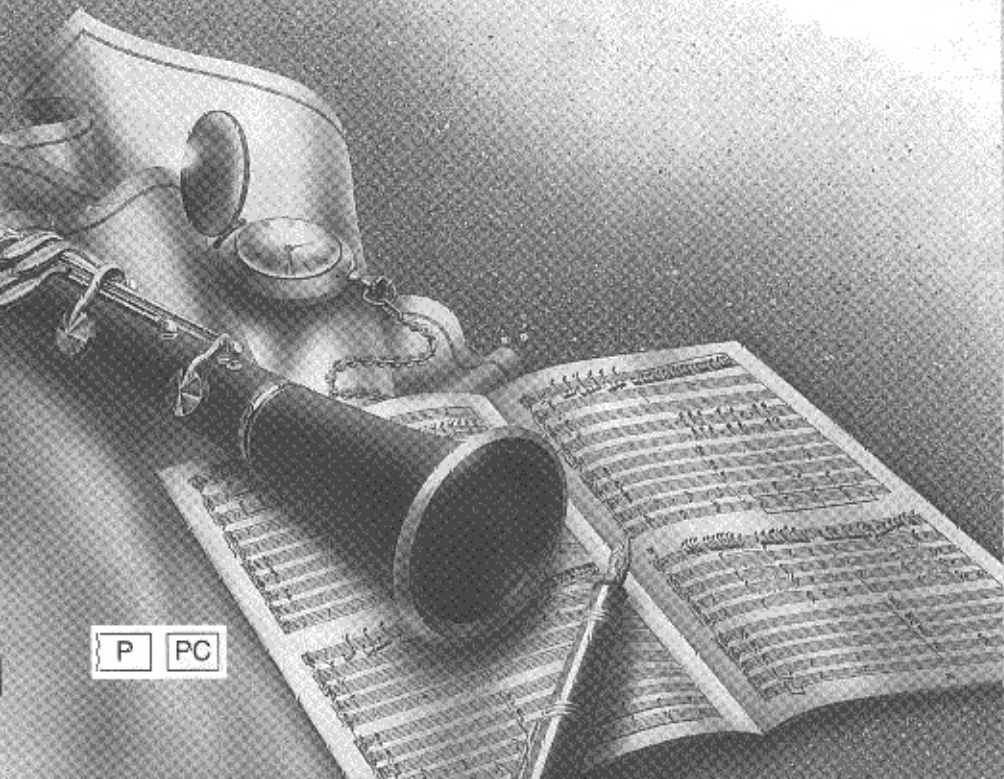

Before connecting, operating or adjusting this product,
please read these instructions completely.
Please save this manual.

P **PC**

RQT4918-P

Dear Customer

Thank you for purchasing this product.
For optimum performance and safety, please read these instructions carefully.

These operating instructions are applicable to models SA-DX930 and SA-DX830, however, are intended primarily for model SA-DX930.

Table of contents

Precautions	3
Supplied accessories	4
Concerning the remote control	4
Surround guide	5
Front panel controls	6
Equipment connections	9
Antenna connections	12
Speaker connections	14
Preparatory steps	16
Speaker settings	16
The speaker indicators	17
Basic operations	18
Listening to radio broadcasts	20
Sequential tuning	20
Direct tuning	21
Preset tuning	22
Digital Signal Processor (DSP)	24
Preparing for surround sound	26
Adjusting speaker output level	26
Adjusting the delay time	27
Enjoying sound modes	29
Adjusting field of sound in the SFC mode	30
Other functions	31
To adjust the tone quality	31
To adjust the sound balance	31
To mute the sound level	31
To listen through headphones	31
Turning the subwoofer off	31
Making a recording	32
Recording on a tape deck	32
Recording on a VCR	32
Using the remote control	33
To operate the receiver	33
To operate a cassette deck	34
To operate a CD changer or CD player	35
To watch TV broadcasts	36
To watch video tapes	37
To operate a DVD player	38
Changing the remote control code SA-DX930 only	39
Troubleshooting guide	40
About the HELP function	41
Technical specifications	42
Listening caution	43
Maintenance	43
Product service	43

User memo:

DATE OF PURCHASE _____
DEALER NAME _____
DEALER ADDRESS _____
TELEPHONE NUMBER _____

The model number and serial number of this product can be found on either the back or the bottom of the unit. Please note them in the space provided below and keep for future reference.
MODEL NUMBER _____
SERIAL NUMBER _____

THE FOLLOWING APPLIES ONLY IN THE U.S.A.

CAUTION:

Any unauthorized changes or modifications to this equipment would void the user's authority to operate this device.

WARNING:

TO REDUCE THE RISK OF FIRE, ELECTRIC SHOCK OR PRODUCT DAMAGE, DO NOT EXPOSE THIS APPLIANCE TO RAIN, SPLASHING, DRIPPING OR MOISTURE.

CAUTION:

TO PREVENT ELECTRIC SHOCK MATCH WIDE BLADE OF PLUG TO WIDE SLOT, FULLY INSERT.



CAUTION

RISK OF ELECTRIC SHOCK
DO NOT OPEN



CAUTION: TO REDUCE THE RISK OF ELECTRIC SHOCK, DO NOT REMOVE SCREWS. NO USER-SERVICEABLE PARTS INSIDE. REFER SERVICING TO QUALIFIED SERVICE PERSONNEL.



The lightning flash with arrowhead symbol, within an equilateral triangle, is intended to alert the user to the presence of uninsulated "dangerous voltage" within the product's enclosure that may be of sufficient magnitude to constitute a risk of electric shock to persons.



The exclamation point within an equilateral triangle is intended to alert the user to the presence of important operating and maintenance (servicing) instructions in the literature accompanying the appliance.

Precautions

Before using this unit please read these operating instructions carefully. Take special care to follow the warnings indicated on the unit itself as well as the safety suggestions listed below. Afterwards keep them handy for future reference.

Safety

1. **Power Source**—The unit should be connected to power supply only of the type described in the operating instructions or as marked on the unit.
2. **Polarization**—If the unit is equipped with a polarized AC power plug (a plug having one blade wider than the other), that plug will fit into the AC outlet only one way. This is a safety feature. If you are unable to insert the plug fully into the outlet, try reversing the plug. If the plug should still fail to fit, contact your electrician to replace your obsolete outlet. Do not defeat the safety purpose of the polarized plug.
3. **Power Cord Protection**—AC power supply cords should be routed so that they are not likely to be walked on or pinched by items placed upon or against them. Never take hold of the plug or cord if your hand is wet, and always grasp the plug body when connecting or disconnecting it.
4. **Nonuse Periods**—When the unit is not used, turn the power off. When left unused for a long period of time, the unit should be unplugged from the household AC outlet.

Installation

Environment

1. **Outdoor Antenna Grounding**—If an outside antenna is connected to the receiver, be sure the antenna system is grounded so as to provide some protection against voltage surges and built-up static charges. Section 810 of the National Electrical Code, ANSI/NFPA No. 70-1990, provides information with respect to proper grounding of the mast and supporting structure, grounding of the lead-in wire to an antenna discharge unit, size of grounding conductors, location of antenna-discharge unit, connection to grounding electrodes, and requirements for the grounding electrode. See figure below.

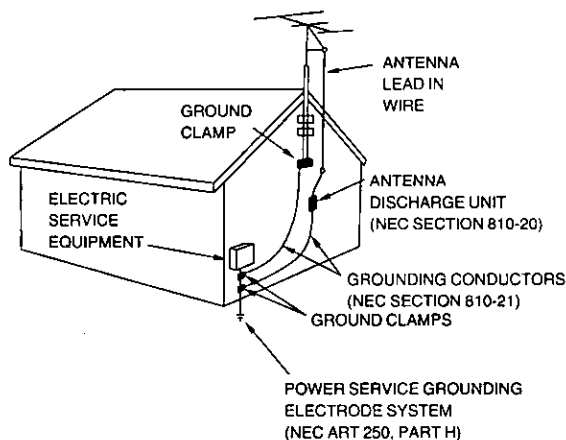

NEC—NATIONAL ELECTRICAL CODE

2. **Water and Moisture**—Do not use this unit near water—for example, near a bathtub, washbowl, swimming pool, or the like. Damp basements should also be avoided.
3. **Heat**—The unit should be situated away from heat sources such as radiators and the like. It also should not be placed in temperatures less than 5°C (41°F) or greater than 35°C (95°F).

Placement

1. **Ventilation**—The unit should be situated so that its location or position does not interfere with its proper ventilation. Allow 10 cm (4") clearance from the rear of the unit.
2. **Foreign Material**—Care should be taken so that objects do not fall into and liquids are not spilled into the unit. Do not subject this unit to excessive smoke, dust, mechanical vibration, or shock.
3. **Magnetism**—The unit should be situated away from equipment or devices that generate strong magnetic fields.
4. **Stacking**—Do not place heavy objects, other than system components, on top of the unit.
5. **Surface**—Place the unit on a flat, level surface.
6. **Carts and Stands**—The unit should be used only with a cart or stand that is recommended by the manufacturer. The unit and cart combination should be moved with care. Quick stops, excessive force, and uneven surfaces may cause the unit and cart combination to overturn.
7. **Wall or Ceiling Mounting**—The unit should not be mounted to a wall or ceiling, unless specified in this operating instructions.



Maintenance

Clean the cabinet, panel and controls with a soft cloth lightly moistened with mild detergent solution. Do not use any type of abrasive pad, scouring powder or solvent such as alcohol or benzene.

Service

1. **Damage Requiring Service**—The unit should be serviced by qualified service personnel when:
 - (a) The AC power supply cord or the plug has been damaged; or
 - (b) Objects have fallen or liquid has been spilled into the unit; or
 - (c) The unit has been exposed to rain; or
 - (d) The unit does not appear to operate normally or exhibits a marked change in performance; or
 - (e) The unit has been dropped, or the enclosure damaged.
2. **Servicing**—The user should not attempt to service the unit beyond that described in the operating instructions. All other servicing should be referred to an authorized service personnel.

For the address of an authorized servicenter:

In the U.S.A. 1-800-211-7262 or web site

(<http://www.panasonic.com>)

In Canada 905-624-5505 or web site

(www.panasonic.ca/feedback.html)

Supplied accessories

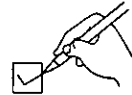
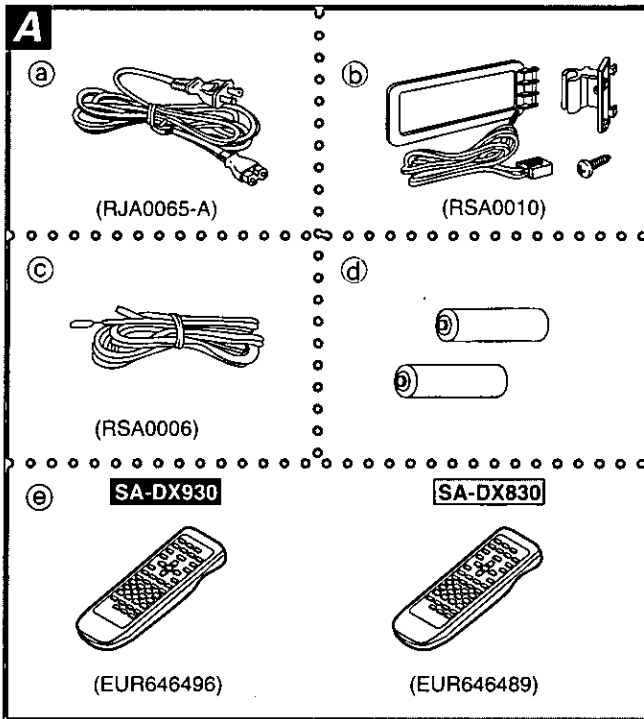

Please check and identify the supplied accessories.

- (a) AC power supply cord 1 pc.
- (b) AM loop antenna set
 - AM loop antenna 1 pc.
 - AM loop antenna holder 1 pc.
 - Screw 1 pc.
- (c) FM indoor antenna 1 pc.
- (d) Batteries 2 pcs.
- (e) Remote control transmitter 1 pc.

Use numbers indicated in parentheses when asking for replacement parts.

(Only for U.S.A.)

To order accessories contact 1-800-332-5368 or web site (<http://www.panasonic.com>).

Concerning the remote control

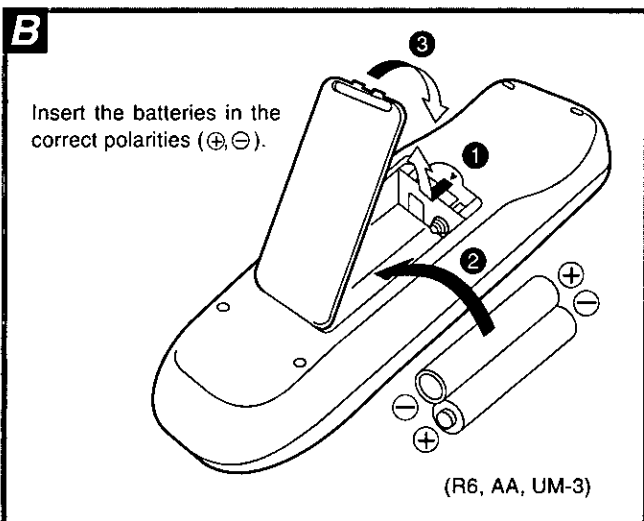

Battery installation

Use of batteries

- Do not mix old and new batteries, or batteries of different types (manganese and alkaline, etc.).
- Never subject batteries to excessive heat or flame; do not attempt to disassemble them; and be sure they are not short-circuited.
- If the remote control is not to be used for a long period of time, remove the batteries and store them in a cool, dark place.
- Do not attempt to recharge alkaline or manganese batteries.
- Do not use rechargeable type batteries.

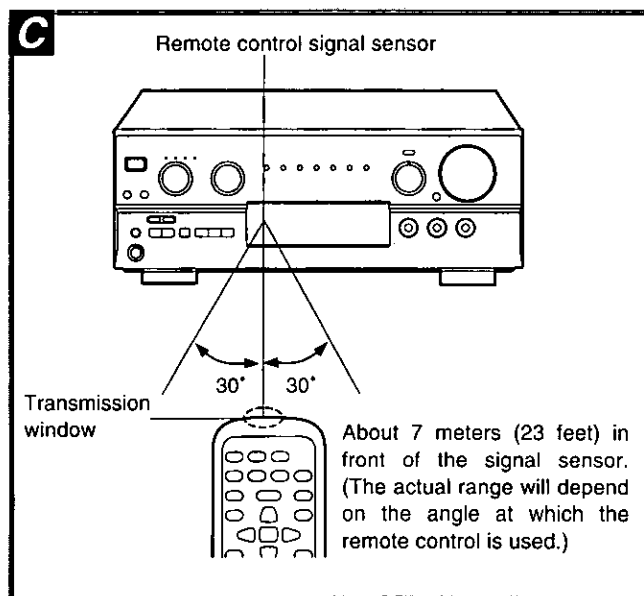

Correct method of use



Operation notes

- Do not place obstacles between the remote control signal sensor and remote control unit.
- Do not expose the remote control signal sensor to direct sunlight or to the bright light of an inverter fluorescent light.
- Take care to keep the remote control signal sensor and end of the remote control unit free from dust.
- If the unit is installed in a rack with glass doors, the glass doors' thickness or color might make it necessary to use the remote control a shorter distance from the unit.

To prevent damage

- Never place heavy items on top of the unit.
- Do not disassemble or reconstruct the unit.
- Do not spill water or other liquids into the unit.

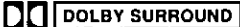
You are able to enjoy these surround systems with this receiver.

Surround system	Features	Software
<p>Dolby Pro Logic</p>	<p>Dolby Pro Logic is a decoding system that was developed to get a better sense of presence from sources encoded with Dolby Surround. The feeling of position has been improved by the addition of a separate center speaker channel. Dolby Surround was developed to allow enjoyment of Dolby Stereo, a cinema system, in private homes. This system reproduces sound close to that of the original movie through use of an analog matrix.</p> <p>(⇒ Page 24.)</p>	<ul style="list-style-type: none"> • Video tapes • Laser discs • DVDs • CDs <p>Software encoded with Dolby Surround can be identified with this mark.</p> 
<p>Dolby Digital (AC-3)</p>	<p>Dolby Digital is a discrete 6 (5.1) channel digital surround system developed for cinema use. The sound signals in Dolby Digital format are compressed to 1/12 their original size, allowing an entire movie to be recorded on a single DVD. Not all Dolby Digital sources are recorded with 6 channels. Some sources marked Dolby Digital may be recorded in Dolby Surround, a 2 channel system.</p> <p>(⇒ Page 24.)</p>	<ul style="list-style-type: none"> • DVDs <p>Software encoded with Dolby Digital can be identified with this mark.</p> 
<p>DTS</p>	<p>DTS is a discrete 6 (5.1) channel digital surround system developed for cinema use. Sources encoded in DTS are only compressed to a quarter of the size of the original to preserve sound quality. DTS sources are produced with the intention that all speaker channels will be used.</p> <p>(⇒ Page 24.)</p>	<ul style="list-style-type: none"> • DVDs • Laser discs • CDs <p>Software encoded with DTS can be identified with this mark.</p> 
<p>SFC (Sound Field Control)</p>	<p>The receiver itself produces the surround effects with sources other than those above. Various effects, like a concert hall or jazz club, can be achieved by introducing width or reverberation to the original sound.</p> <p>(⇒ Page 25.)</p>	<p>Any kind, but particularly music CDs and video tapes.</p>

Before use

Manufactured under license from Dolby Laboratories. "Dolby", "Pro Logic" and the double-D symbol are trademarks of Dolby Laboratories. Confidential Unpublished Works. © 1992-1997 Dolby Laboratories, Inc. All rights reserved.

This product is manufactured under licence from DTS, Inc. of America.

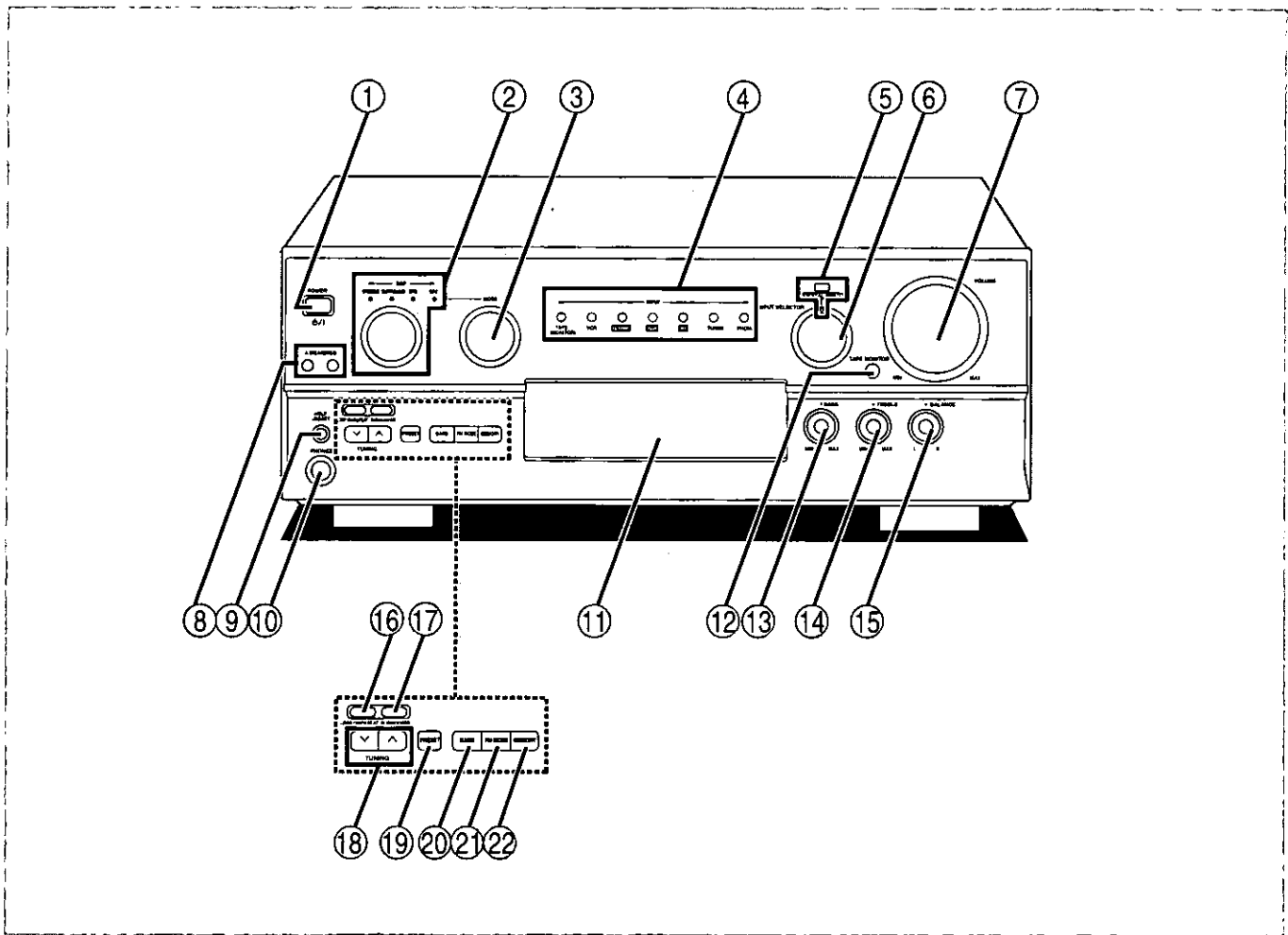

Main unit

No.	Name	Ref.page
①	Power “⏻” switch (POWER, ⏻ / I)	16
	Press to switch the unit from on to standby mode or vice versa. In standby mode, the unit is still consuming a small amount of power.	
②	Sound mode selector (DSP)	24
③	SFC mode selector (MODE)	25
④	Input indicator	18
⑤	Digital input select button/indicator (DIGITAL INPUT)	18
⑥	Input selector (INPUT SELECTOR)	18
⑦	Volume control (VOLUME)	18
⑧	Speaker select buttons (A SPEAKERS B)	16, 18
⑨	Help/reset button (-HELP, -RESET)	41

No.	Name	Ref.page
⑩	Headphones jack (PHONES)	31
⑪	Display section	7
⑫	Tape monitor button (TAPE MONITOR)	19
⑬	Bass control (BASS)	31
⑭	Treble control (TREBLE)	31
⑮	Balance control (BALANCE)	31
⑯	Digital signal processor on/defeat button (-DSP ON/DEFEAT)	20, 25
⑰	Subwoofer button (SUBWOOFER)	17, 31
⑱	Tuning buttons (TUNING ∇, ∧)	20
⑲	Preset channel button (PRESET)	23
⑳	Band select button (BAND)	20
㉑	FM mode select button (FM MODE)	20
㉒	Memory button (MEMORY)	22

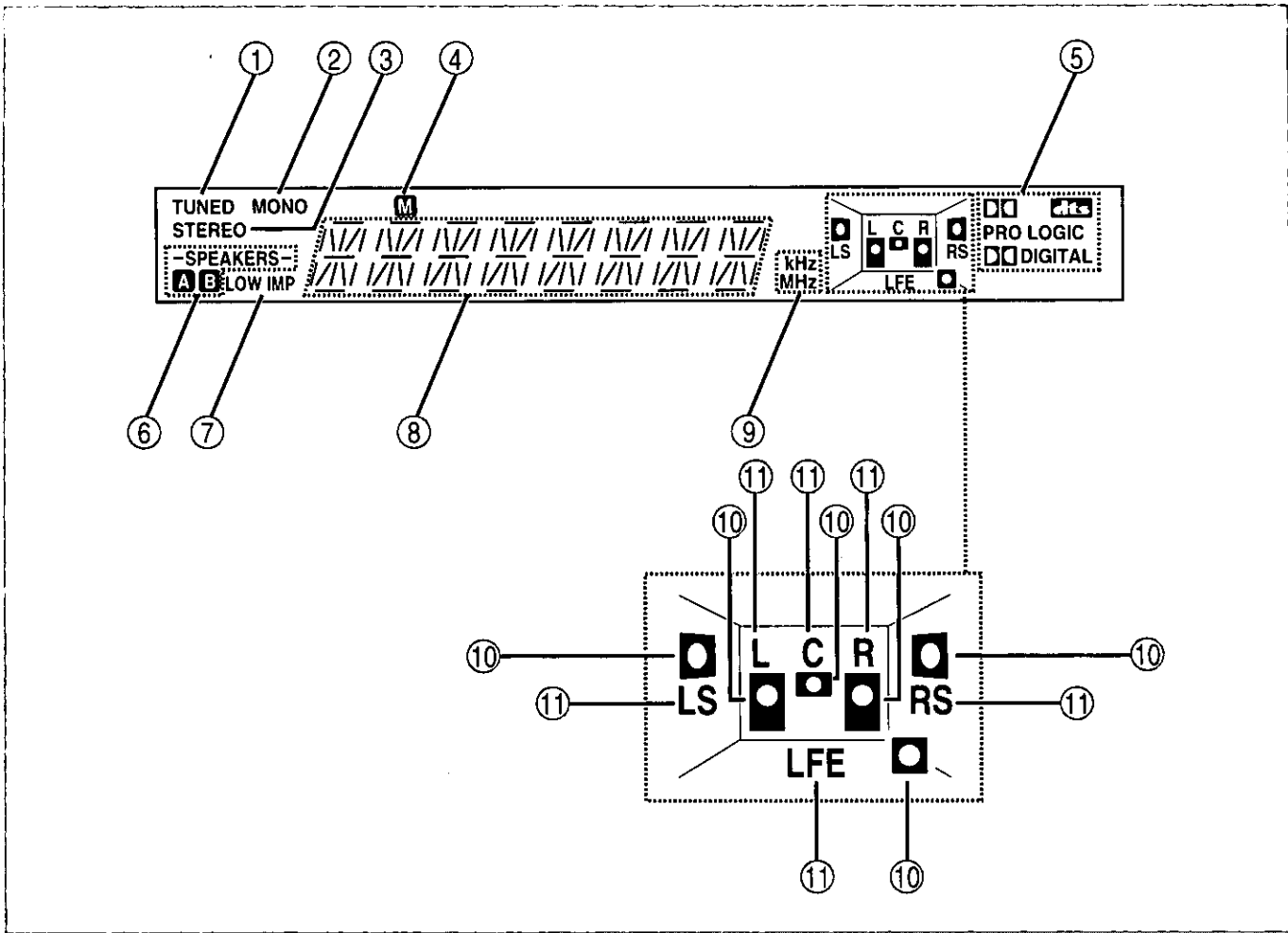

Before use

Display section

No.	Name	Ref.page
①	Tuned indicator (TUNED)	20
②	Monaural indicator (MONO)	20
③	Stereo indicator (STEREO)	20
④	Memory indicator (M)	22
⑤	Surround format indicators (DTS, PRO LOGIC, DIGITAL)	24
⑥	Front speaker indicator (-SPEAKERS- A B)	18
⑦	Low impedance indicator (LOW IMP)	19
⑧	Display	
⑨	Frequency unit indicator (kHz, MHz)	20

No.	Name	Ref.page
⑩	Speaker indicators	17
⑪	Signal format indicators (L, C, R, LS, RS, LFE)	
	These indicators light up to indicate each input signal format.	
	L: Front channel (left)	
	C: Center channel	
	R: Front channel (right)	
	LS: Surround channel (left)	
	RS: Surround channel (right)	
	"LFE" (Low Frequency Effect) is a channel for the deep-bass effect in the low frequency range.	

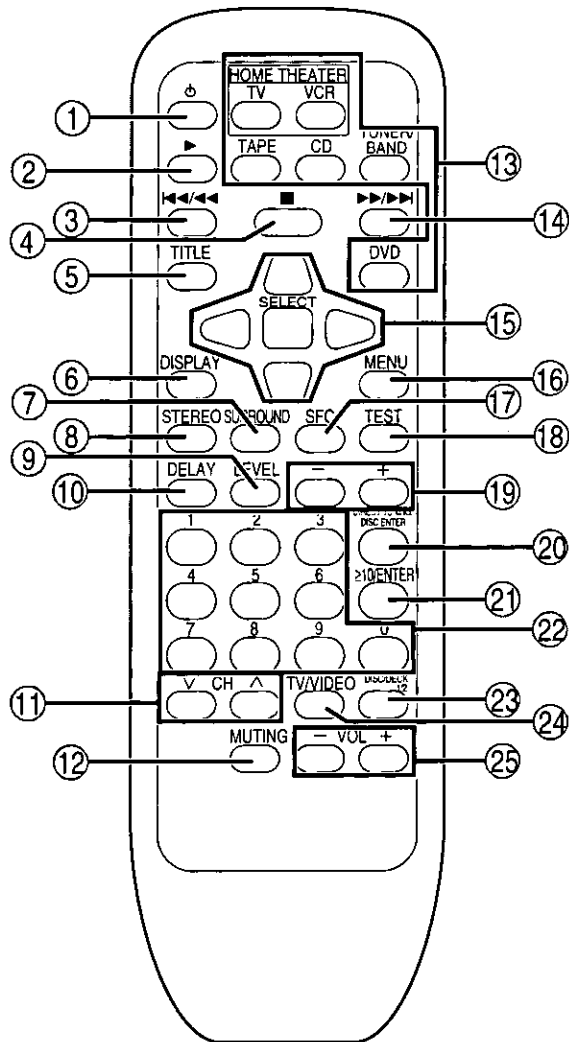

Remote control

No.	Name	Ref. page
①	Power button (⏻)	33
②	▶ button (▶)	34
③	⏮/◀ button (⏮/◀)	34
④	■ button (■)	34
⑤	Title button (TITLE)	38
⑥	Display button (DISPLAY)	38
⑦	Surround mode select button (SURROUND)	26, 33
⑧	Stereo mode select button (STEREO)	33
⑨	Speaker channel select button (LEVEL)	26, 33
⑩	Delay time button (DELAY)	27, 33
⑪	Channel up/down buttons (∇CH∧)	34
⑫	Muting button (MUTING)	31, 33
⑬	Input select buttons (TV, VCR, TAPE, CD, TUNER/BAND, DVD)	33
⑭	▶▶/▶▶ button (▶▶/▶▶)	34
⑮	Cursor/select buttons	38
⑯	Menu button (MENU)	38
⑰	SFC mode select button (SFC)	33
⑱	Test button (TEST)	26, 33
⑲	Delay time/level adjust buttons (–, +)	26, 33
⑳	Direct tuning/disc enter button (DIRECT TUNING/DISC ENTER)	21, 34
㉑	For SA-DX930 ≥10/enter button (≥10/ENTER)	34
	For SA-DX830 ≥10 button (≥10)	34
㉒	Numeric buttons	21, 34
㉓	Disc/deck 1/2 select button (DISC/DECK 1/2)	34
㉔	TV/video select button (TV/VIDEO)	36
㉕	Volume buttons (–VOL+)	26, 33

Equipment connections

Connecting analog equipment

Stereo connection cable (not included)

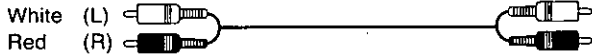

Video connection cable (not included)



Make sure that the power supply for all components has been turned off before making any connections.

To connect equipment, refer to the appropriate operating instructions.

Note

Do not place books, etc., on the top of this unit or block the heat radiation vents in any way.

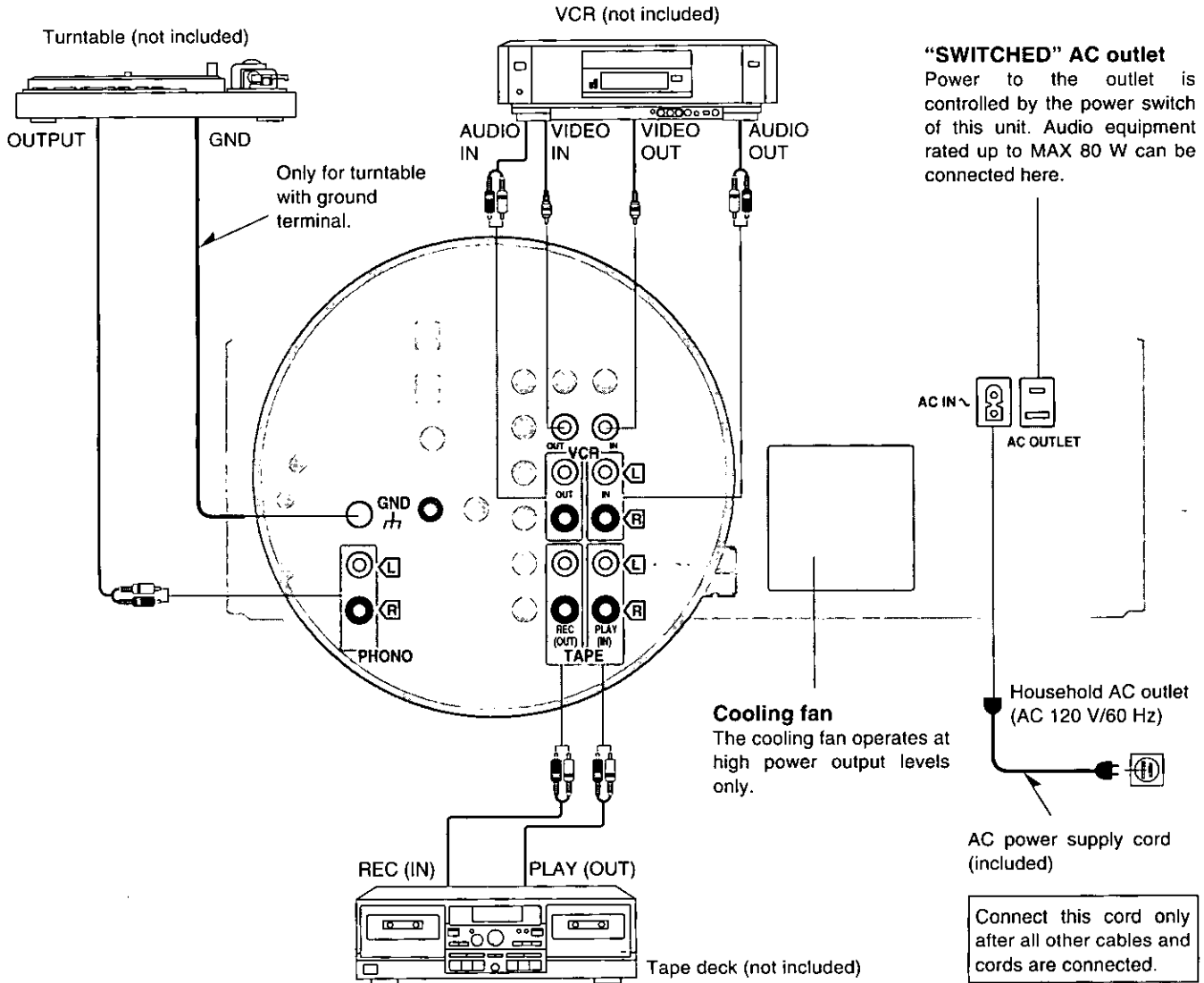

CAUTION

Do not place a tape deck, CD, or DVD player on top of this unit.
Heat radiated from the top of this unit may cause damage to the software.

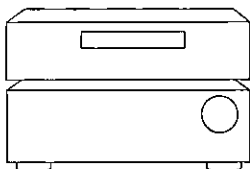

NO

Before use, Connections

Using analog connection for digital equipment

Stereo connection cable (not included)

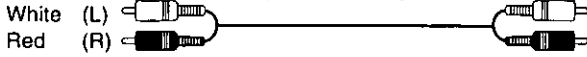

Video connection cable (not included)



Note

Use digital connection to enjoy this unit's surround functions (→ page 11).

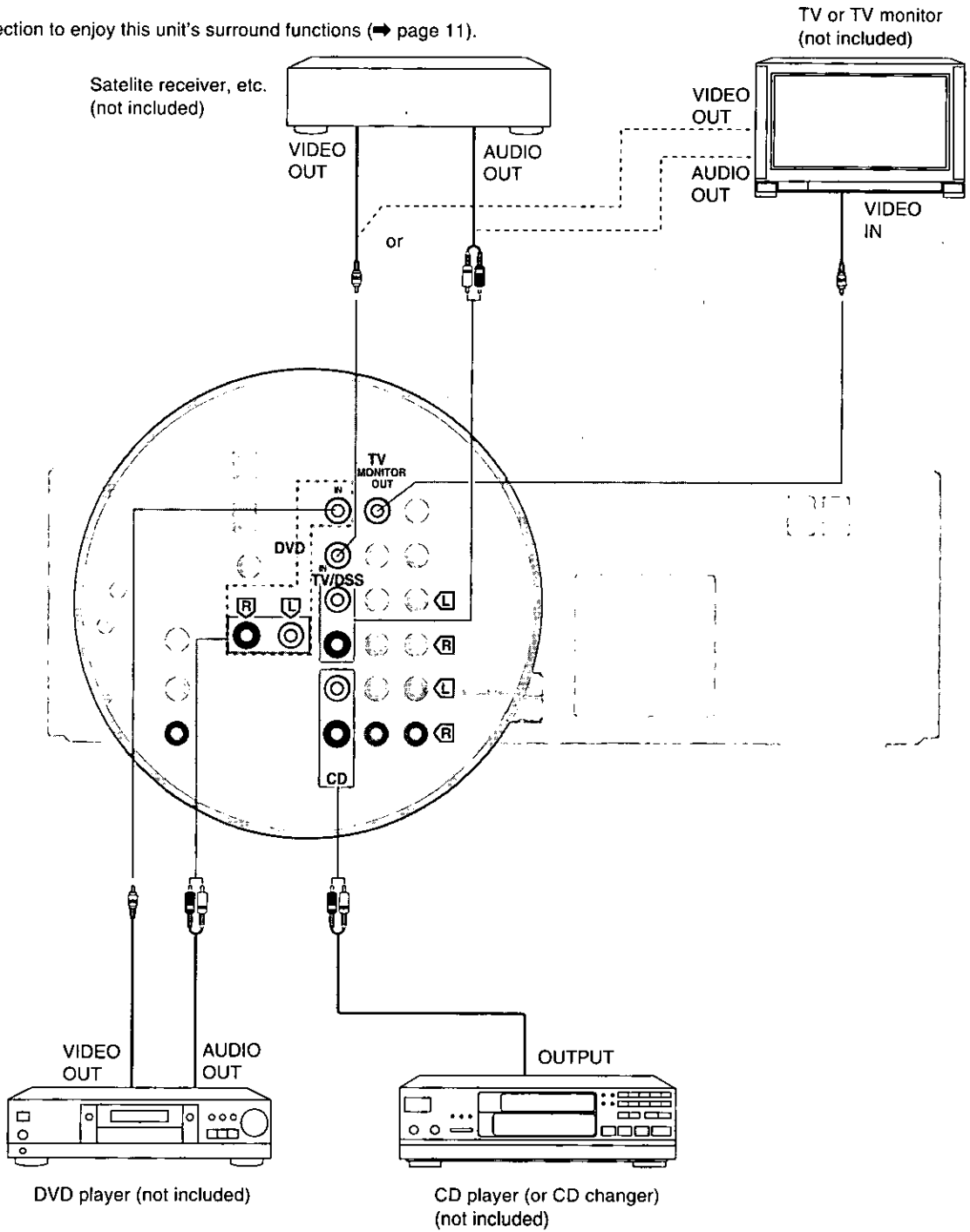

Digital connection

Coaxial cable (not included)



Optical fiber cable (not included)

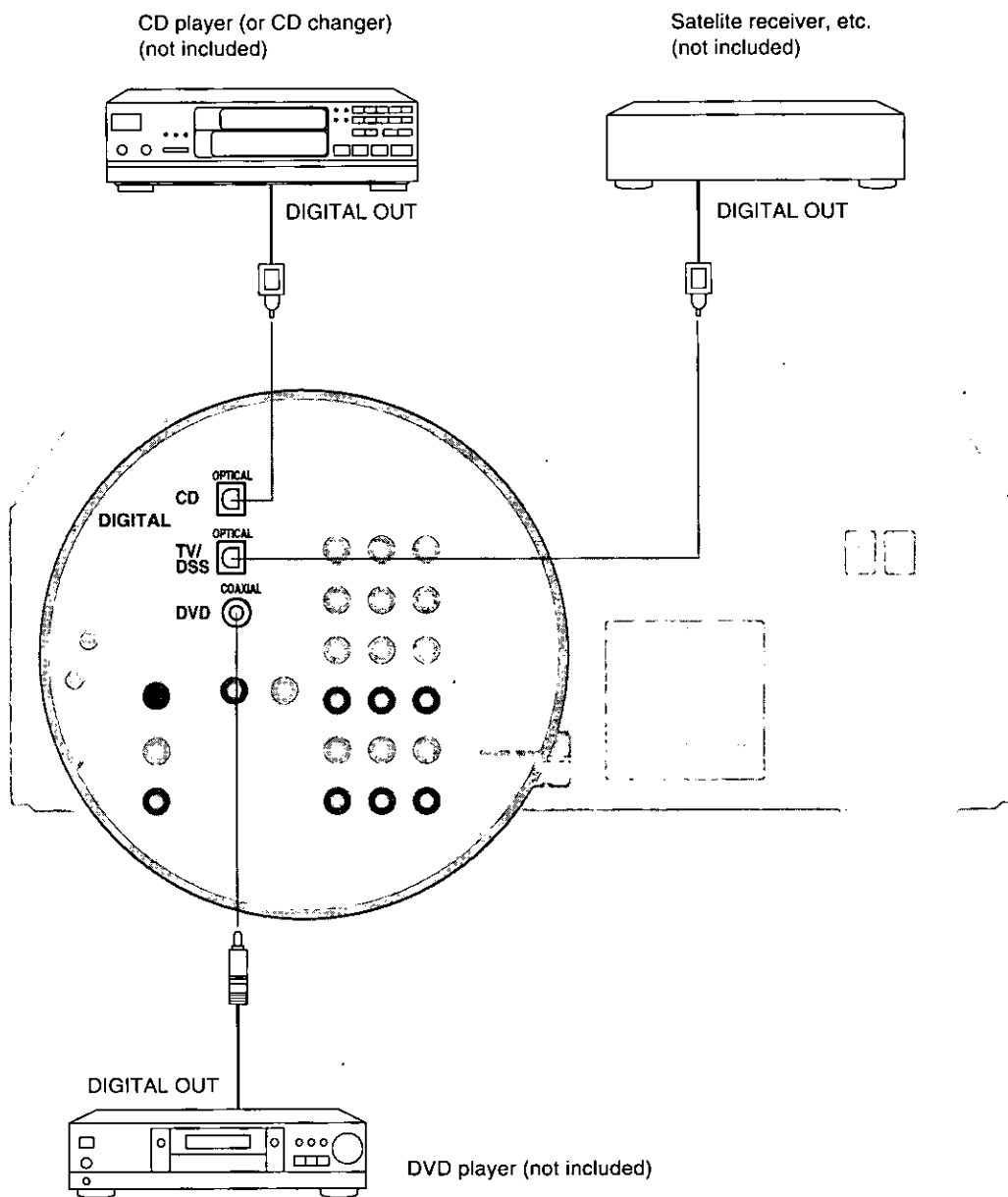
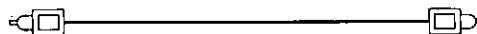

Connection for optical fiber cable

Dust-protection cap

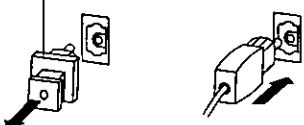

Note

Dolby Digital RF (radio frequency) signals cannot be decoded with this unit even if a unit that has Dolby Digital RF output terminals is connected to this unit.

- Do not bend the optical fiber cable.
- If the digital optical connector is not going to be used, be sure to attach the dust-protection cap to prevent exposure to dust.

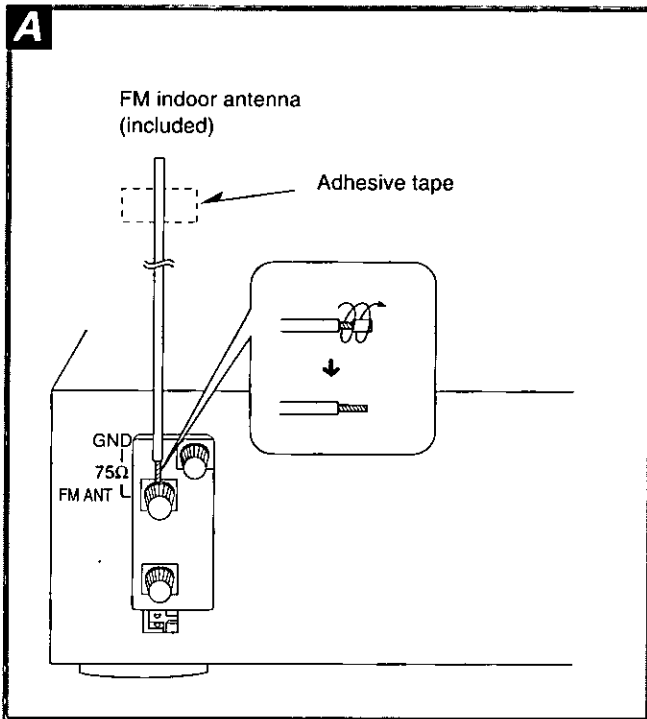

FM indoor antenna (included) **A**

This antenna is normally sufficient for reception of FM broadcasts.

Attach to a wall (using tape) facing in the direction of best reception.

For best reception

An FM outdoor antenna is recommended.

AM loop antenna (included) **B**

This antenna is normally sufficient for reception of AM broadcasts.

Fit the AM loop antenna holder (included) onto the rear panel of this unit and then attach the AM loop antenna to the AM loop antenna holder (facing in the direction of best reception).

Pay attention to the following points when mounting the antenna.

- Do not mount it close to power cords, speaker wires or metal surfaces (doing so will result in noise).
- Do not mount it close to a tape deck. When the tape deck is being used, chirping or beeping sounds may result.

When mounting the antenna to a column, a wall or rack **C**

Mount the antenna so that the hinge is vertical.

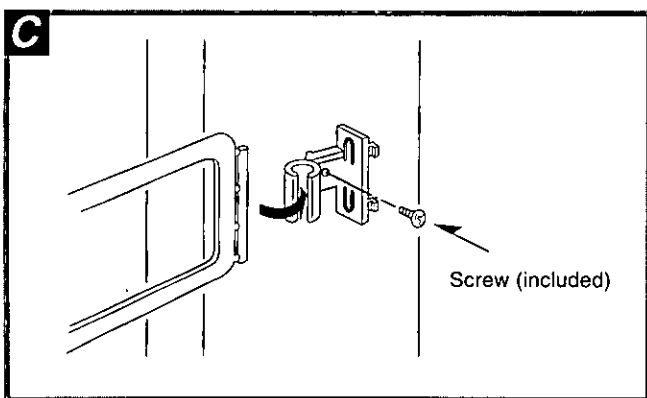
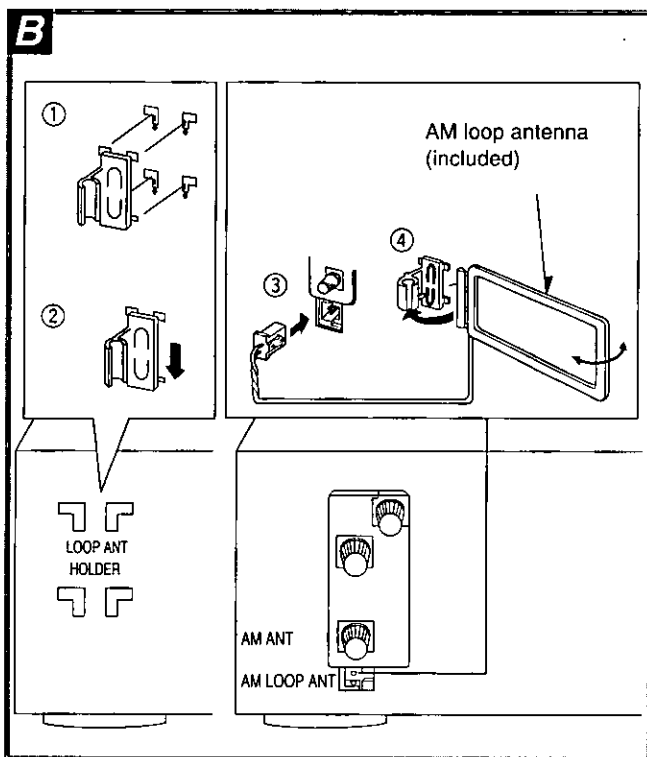

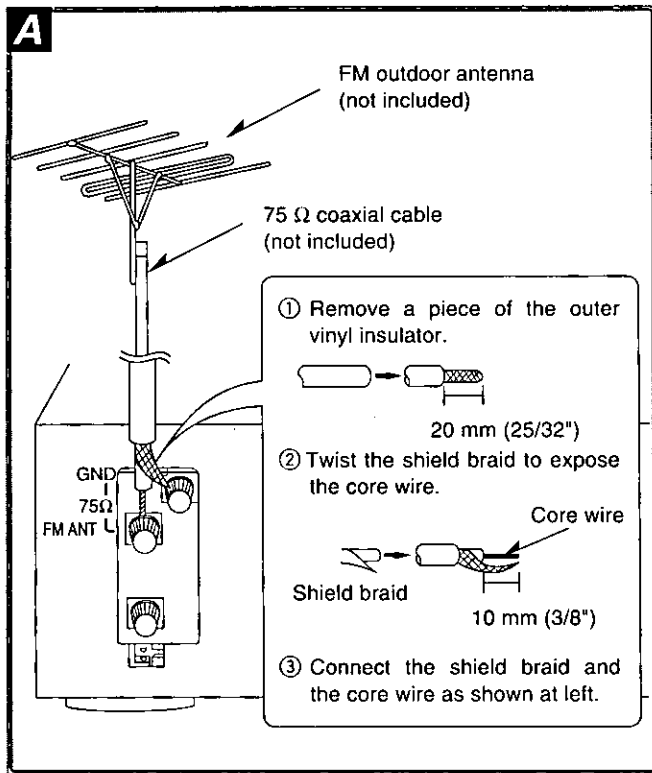

FM outdoor antenna (not included)

A

An outdoor antenna should be used when using this unit in mountainous areas or in spaces enclosed by reinforced concrete where the FM indoor antenna (included) does not provide satisfactory reception.

Disconnect the FM indoor antenna if an FM outdoor antenna is installed.

Note

An outdoor antenna should be installed by a qualified technician only.

AM outdoor antenna (not included)

B

An outdoor antenna should be used when using this unit in mountainous areas or in spaces enclosed by reinforced concrete where the AM loop antenna (included) does not provide satisfactory reception.

Stretch 5–12 m (16–40 ft.) of vinyl-covered wire horizontally across a window frame or other convenient location, keeping it as high as possible from the ground.

When the unit is not in use, disconnect the outdoor antenna to prevent possible damage that may be caused by lightning. Never use an outdoor antenna during an electrical storm.

Note

Be sure to connect the AM loop antenna even when an outdoor antenna is used.

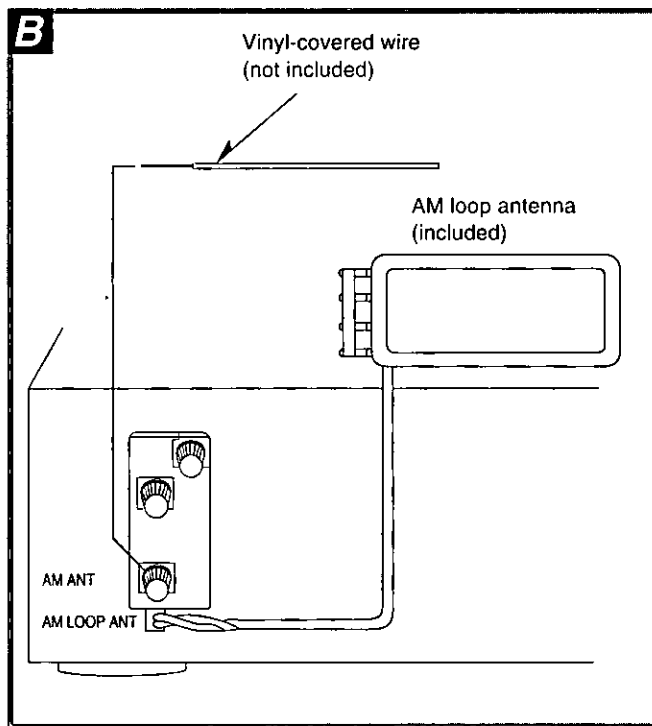

Placement of speakers

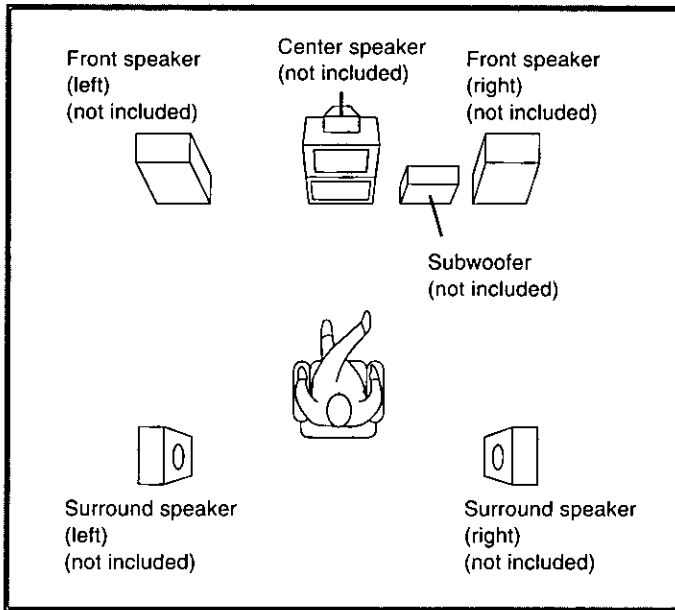

Front speakers

Place the front speakers on the left and right of the TV at seated ear height so that there is good coherency between the picture and sound.

Center speaker

Place this speaker underneath or above the center of the TV. Aim the speaker at the seating area.

Surround speakers

Place those speakers on the side of or slightly behind the listener, and about one meter higher than ear level.

Subwoofer

The subwoofer can be placed in any position as long as it is at a reasonable distance from the TV.

Note that some experimentation can yield the smoothest low frequency performance. Placement near a corner can increase the apparent output level, but can result in unnatural bass.

Connecting speakers

Other connections are possible depending on your speaker system. See your speaker system's operating instructions for details.

Front speakers

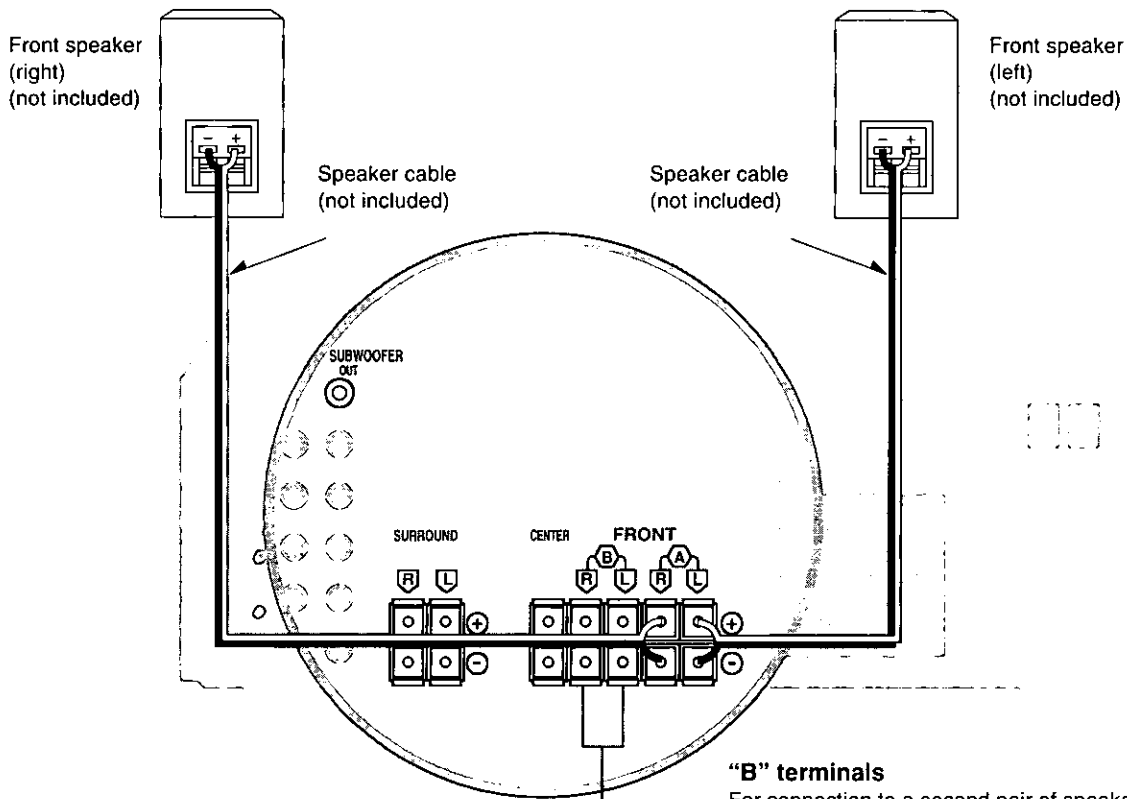

Speaker impedance:

A or B: 4-8 Ω
A and B: 8 Ω

Note

Use the A terminals to enjoy Dolby Digital, Dolby Pro Logic, DTS and SFC.

Other speakers

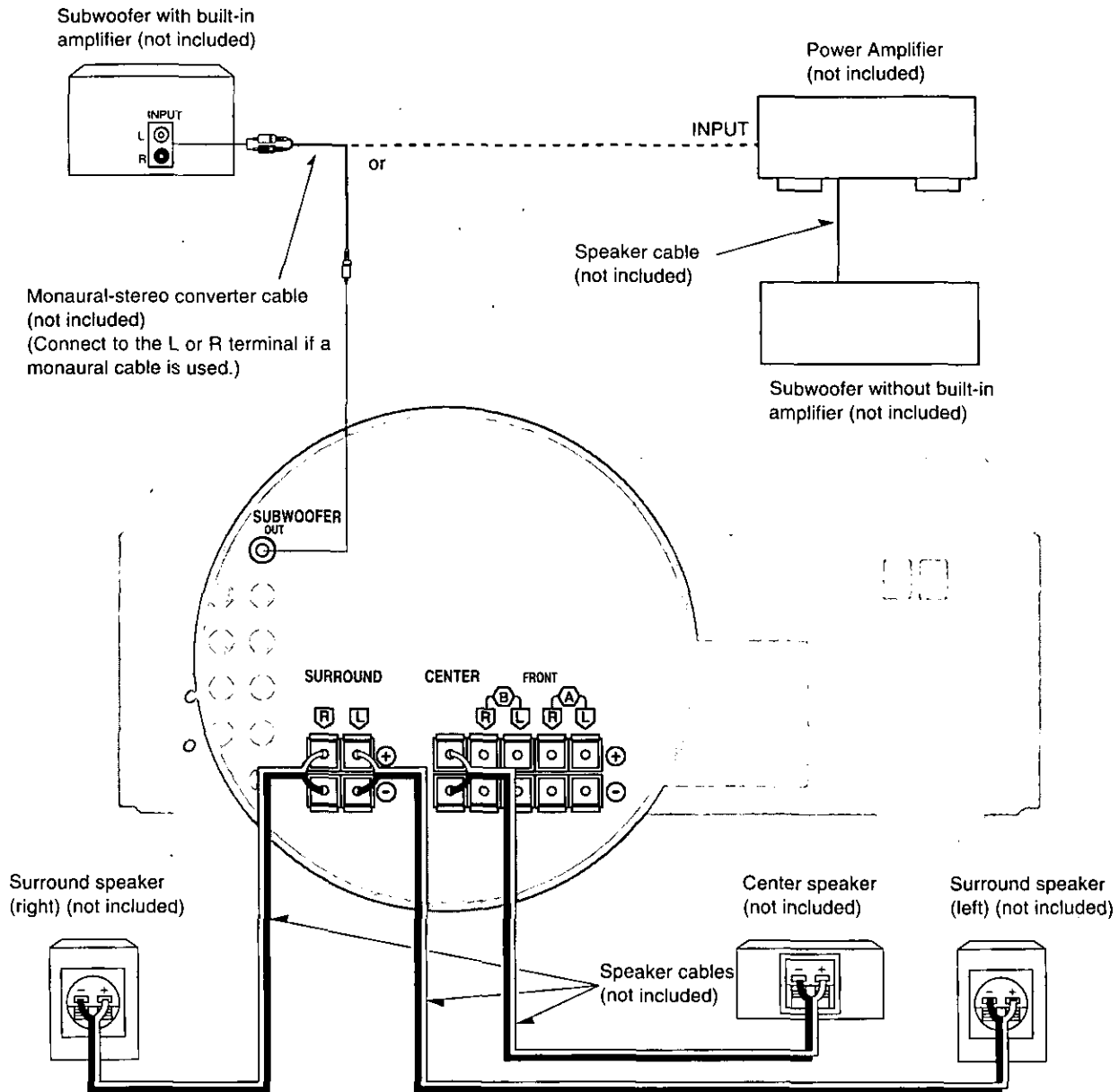

Note

For surround speakers

Do not connect the surround speakers to the front speaker terminals. The surround speakers may be damaged if connected to the front terminals.

For subwoofer

This receiver has no amplifier section designed especially for the subwoofer.

Connecting the cables

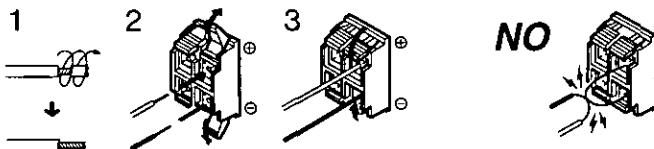

Speaker impedance:

Center speaker: 8 Ω
Surround speaker: 8 Ω

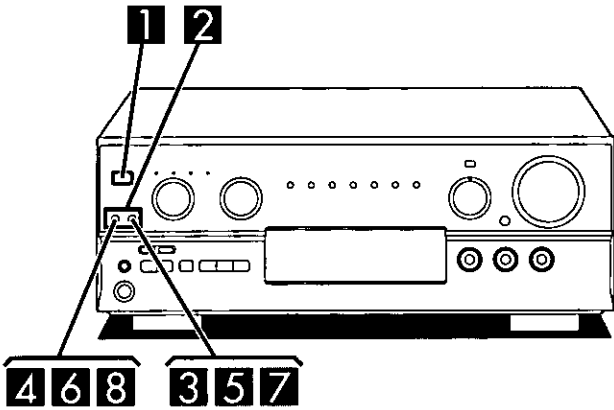

Speaker settings

These settings should be done to get the most from the unit's reproduction modes (→ page 24–25).

Front, center, and surround channel settings

Set the type (LARGE or SMALL) and presence of your speakers. Select "LARGE" if the speakers can produce bass (below around 100 Hz). Select "SMALL" if the speakers cannot produce bass. If you aren't using center or surround speakers select "NONE" so the sound is produced through the front speakers.

Before proceeding:

The speaker channels are all set to "LARGE" before shipping. If all your speakers are LARGE, you may skip this operation.

1	POWER 	
2	A SPEAKERS B SETTING 	SETTING ↓ FRONT
3	A SPEAKERS B SETTING 	LARGE
4	A SPEAKERS B SETTING 	CENTER
5	A SPEAKERS B SETTING 	LARGE
6	A SPEAKERS B SETTING 	SURROUND
7	A SPEAKERS B SETTING 	LARGE
8	A SPEAKERS B SETTING 	COMPLETE

1 Press [POWER].

2 Press [A] and [B] at the same time.
"SETTING" appears on the display and then changes to "FRONT."

3 Press [B] to set the type of front speakers, "LARGE" or "SMALL."

Each time the button is pressed the display switches as follows.

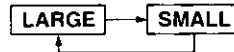

4 Press [A] to select "CENTER."

5 Press [B] to select the type or presence of the center speaker.

Each time the button is pressed the display switches as follows.



Select "NONE" if a center speaker isn't connected.

6 Press [A] to select "SURROUND."

7 Press [B] to select the type or presence of the surround speakers.

Each time the button is pressed the display switches as follows.



Select "NONE" if surround speakers aren't connected.

8 Press [A] to select "COMPLETE."

The settings are now entered into the unit's memory. The previous display reappears after about 3 seconds.

If you have made a mistake in the settings, start again from step 2.

.....
If you allow about 10 seconds to elapse between settings, the procedure is cancelled, all settings are returned to how they were, and the previous display is restored. Begin again if this occurs.

A

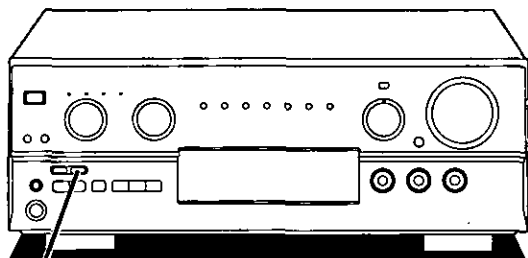

SUBWOOFER

Subwoofer channel setting **A**

Press [SUBWOOFER] to select "ON" or "OFF".
 "SUB-WFR" appears on the display and the current setting, "ON" or "OFF," is shown. Press again to switch between "ON" and "OFF."

ON: select if you are using a subwoofer.

OFF: select if you are not using a subwoofer.

Select "OFF" also when you don't want sound to come from the subwoofer because you are listening to stereo sources.

For your reference:

The settings remain as they are until changed by the above procedure, even after the power has been turned off.

The speaker indicators **B**

This part of the display indicates which speakers sound is coming from.

If "NONE" or "OFF" is selected during the speaker settings procedure, the corresponding indicators do not light.

The surround and center speaker indicators do not light when STEREO mode is selected (➔ page 24).

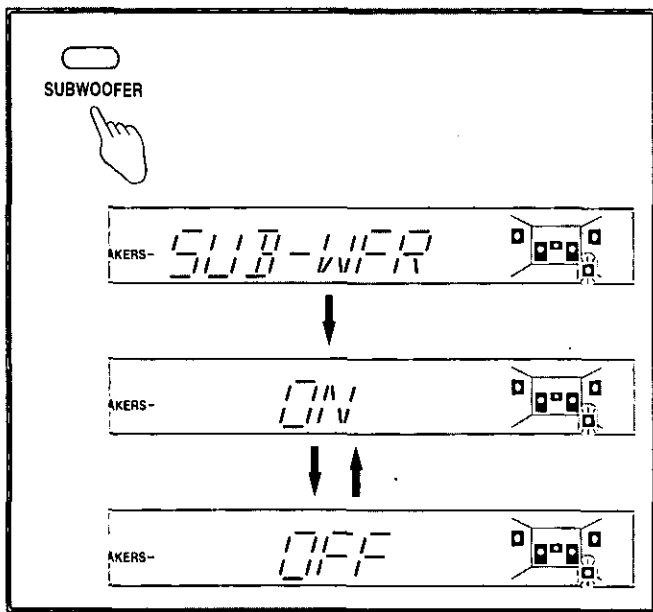

B

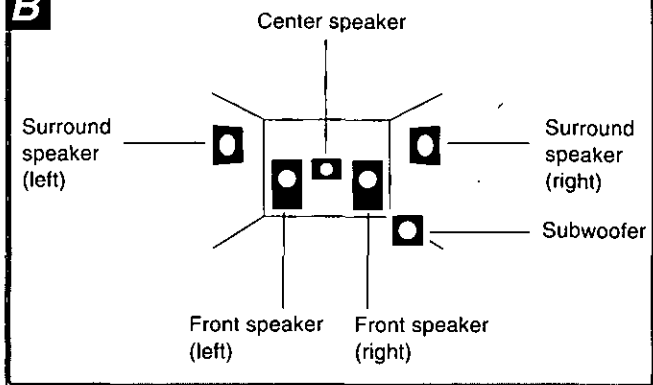

Basic operations

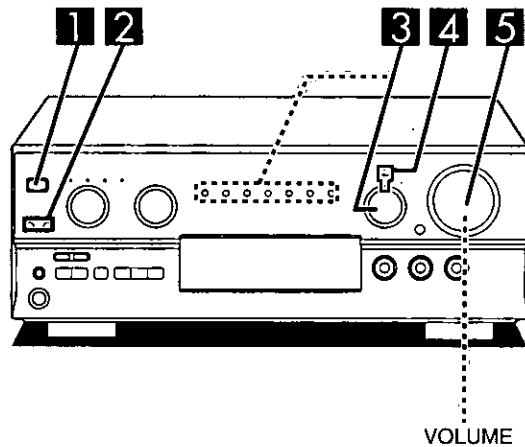

Before operation, set VOLUME to the "MIN" position.

- 1** Press [POWER].
- 2** Press [A] and/or [B] to select the speaker system(s) to be used.
A and B refer to the speaker terminals at the rear of the unit.

If the button is pressed once more, the indicator will switch off and no sound will be heard from the speakers.
- 3** Turn [INPUT SELECTOR] to select and start the desired source.
(Refer to the appropriate operating instructions for details.)

The indicator corresponding to the selected source lights and the source is shown on the display.

TAPE (MONITOR): To listen to cassette tapes

VCR: To watch video tapes

TV/DSS: To watch TV or DSS

DVD: To watch DVD

CD: To listen to compact discs

TUNER: To listen to radio broadcasts

PHONO: To listen to phono discs

Note

To watch a video (or DVD) or the TV, set the TV to either the TV mode or VIDEO mode.

- 4** (only if you select TV/DSS, CD or DVD in the above step) Press [DIGITAL INPUT] to select "DIGITAL" or "ANALOG".
Switches between "DIGITAL" and "ANALOG" each time the button is pressed.

The "DIGITAL INPUT" indicator lights when DIGITAL selected.

- 5** Adjust the volume level.

For your reference

- If the **SURROUND, DTS or SFC mode** has been selected
After displaying the selected source, the display will then change to show the SURROUND, DTS or SFC mode.
(➔ page 24-25)
If the source chosen was TUNER then the display will change again to show the frequency.
- If you are using **VCR** and you select **TAPE, CD, TUNER, or PHONO**
The picture will remain on the screen.

When you finish listening

Be sure to reduce the volume level, and switch the power to the standby condition by pressing [POWER].

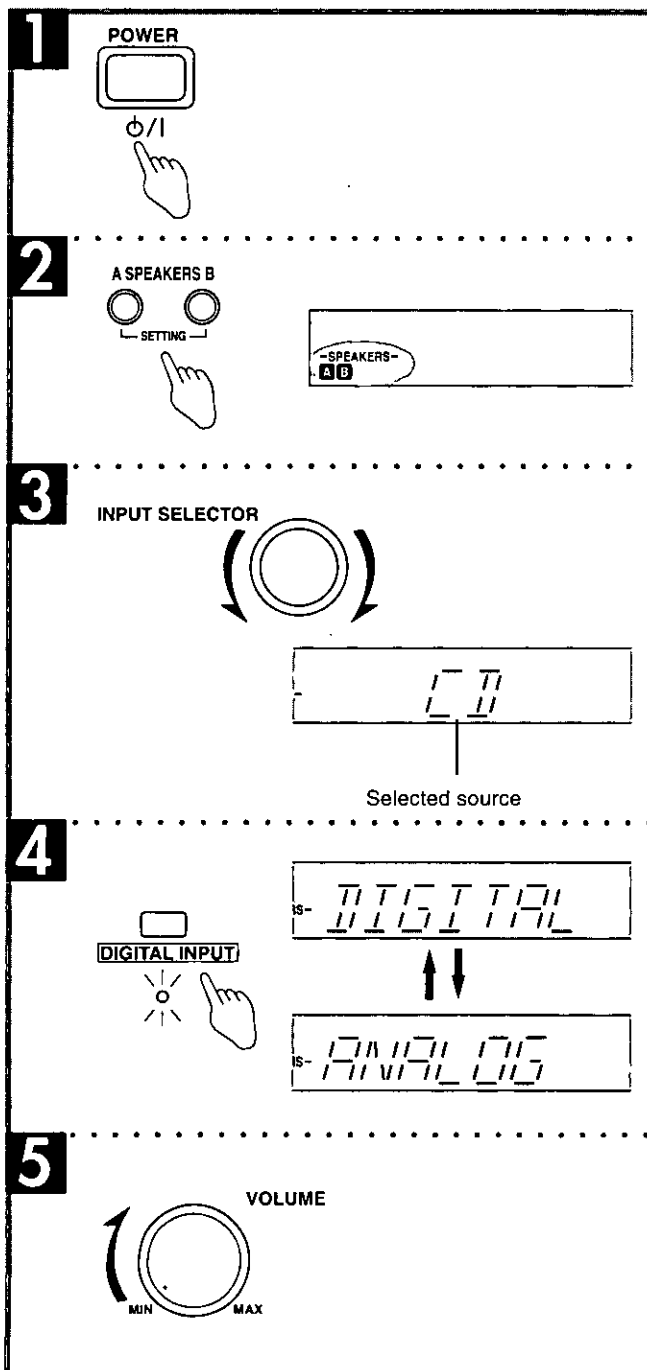

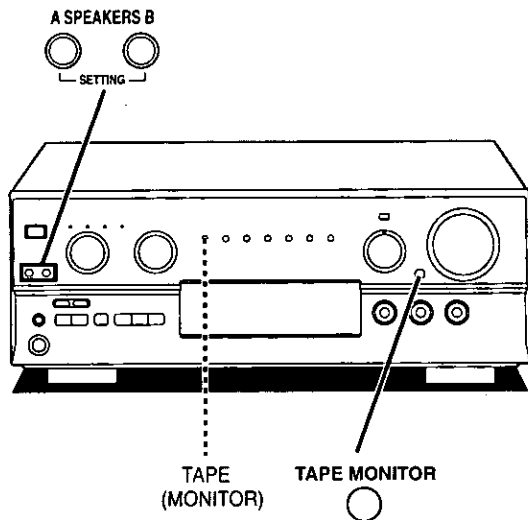

For front speakers with an impedance under 8 Ω **A**

Press and hold [A] or [B] until “LOW IMP” lights up on the display.

If even one of the speakers being used has an impedance under 8 Ω, press and hold down either [A] or [B] for 4 seconds or more to set the impedance on the main unit to LOW.

(Press and hold down once again for 4 seconds or more to turn it off.)

Note that when “LOW IMP” is illuminated, speakers A and B cannot both be used at the same time.

To change a speaker:

e.g. To use speaker B, press [A] (“A” goes out), and then press [B] to activate speaker B.

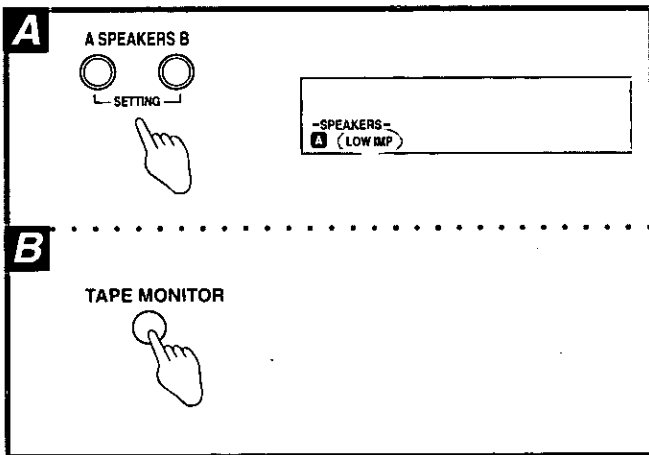

The TAPE (MONITOR) indicator

This indicator lights in the following two situations:

1. While TAPE is selected.
2. While TAPE MONITOR is in use.

To use the tape monitor **B**

If [TAPE MONITOR] is pressed while a source other than TAPE is selected, the “TAPE (MONITOR)” indicator lights and the tape monitor comes on.

Sources other than tape can still be selected with [INPUT SELECTOR] while the “TAPE (MONITOR)” indicator is on.

Press [TAPE MONITOR] again to turn the tape monitor off.

(⇒ See “Making a recording” on page 32 for details on how to use the tape monitor during recording.)

Note

- The tape monitor cannot be used when TV/DSS, DVD, or CD digital input is being used.
- If you are using the tape monitor and you select a digital input source, the tape monitor switches off.

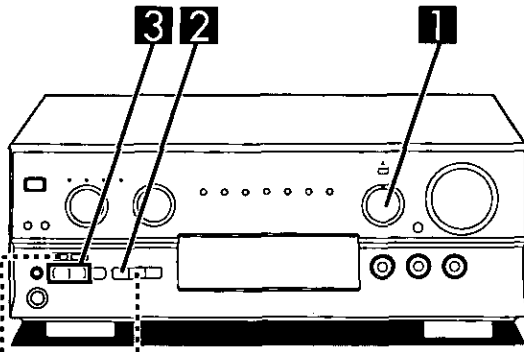

-DSP ON/DEFEAT FM MODE

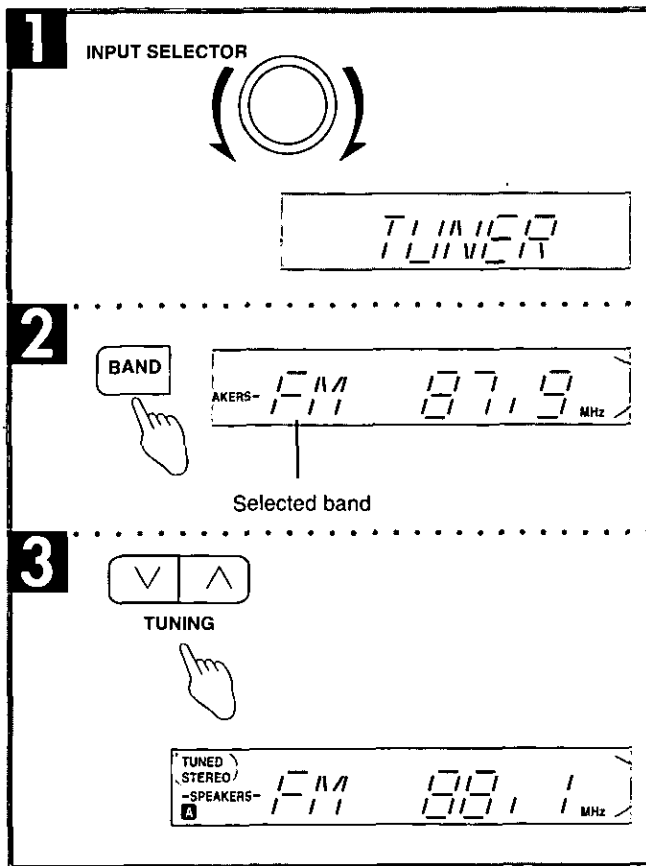

Sequential tuning

Use the tuning buttons to tune-in radio stations.

- 1** Turn [INPUT SELECTOR] to select "TUNER".
- 2** Press [BAND] to select "FM" or "AM".
- 3** Press [TUNING (∨ or ∧)] to tune to the desired frequency.

"TUNED" lights up when tuned.

"STEREO" lights up when an FM stereo broadcast is received.

To make an automatic search for stations

If [TUNING (∨ or ∧)] is held down for an instant until the frequency begins to scroll, the broadcast stations are tuned in automatically when one is found.

Note

Tuning may stop automatically if any jamming is encountered.

If noise is excessive in the FM stereo mode

Press [FM MODE].

("STEREO" will go out, and "MONO" will light up).

The broadcast will be monaural, but noise will be reduced.

If the button is pressed once more, the stereo mode resumes.

If there is hissing or thumping while the radio is playing

Press and hold [-DSP ON/DEFEAT] to select "DEFEAT".

(→ Page 25 for details about DSP DEFEAT.)

For your reference

The tuner can pick up interference from DVD players. If this occurs turn the DVD player off.

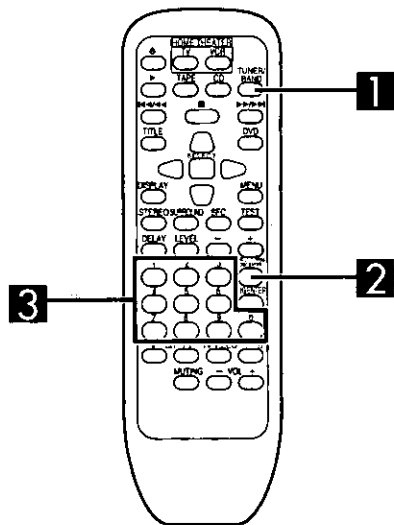

Direct tuning

by remote control only

Specify the frequency using the numeric buttons on the remote control transmitter to directly tune to the desired station.

1 Press [TUNER/BAND].

This will set the remote control to operate the tuner. The selector on the receiver will change to "TUNER". Each time the button is pressed, the band will change as follows,
FM \rightleftarrows AM.

2 Press [DIRECT TUNING/DISC ENTER].

3 While cursor display is flashing (approx. 10 seconds) Press the numeric buttons to enter the frequency.

If the desired FM frequency is 107.9 MHz, press

[1] → [0] → [7] → [9].

If the frequency has been input correctly, the displayed frequency will blink once.

Note

1. If no button is pressed while the cursor display is flashing, the display will return to the frequency which is currently being received. To re-specify the frequency, repeat the procedure from step 2.
2. If the frequency has not been input correctly, "ERROR" will be displayed. In this case, re-enter the frequency.

1

Selected band

2

3

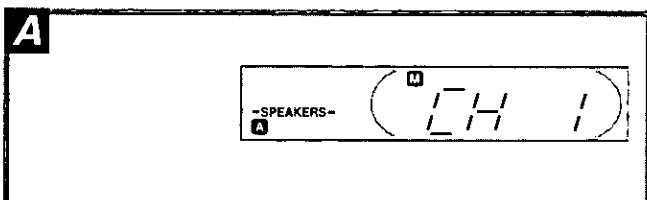
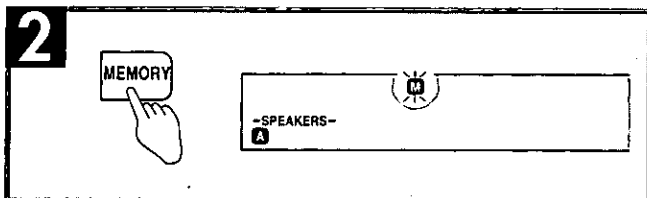
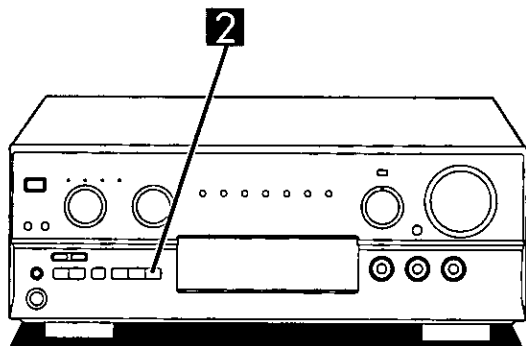

Preset tuning

Presetting radio stations into the memory channels of this unit makes selecting stations simple.

A total of 30 FM and AM stations can be preset.

Please remember this

If a new broadcast station is preset into a channel, the setting for the broadcast station which was previously entered in that channel will be automatically erased.

Automatic memory presetting

Automatic memory presetting allows this unit to automatically search for broadcast stations and then preset them into memory. With this method, the channels that can be preset into the memory are set as follows for different bands (FM or AM).

When FM stations are preset,

For FM stations 1-30

When FM and AM stations are preset,

For FM stations 1-20

For AM stations 21-30

1 Set to the frequency from which you want to start automatic memory presetting. (➔ Page 20-21.)

2 Press [MEMORY] until the frequency begins to change.

(Automatic memory presetting will start.)

During automatic memory presetting, the memory indicator will flash while the frequency scrolls.

To stop, press [MEMORY] again.

.....
When a broadcast station is preset **A**

The memory indicator and the preset channel number will be displayed for approximately 1 second.

When presetting is completed

The last broadcast station to be preset will be displayed.

Note

Frequencies may not be preset correctly in cases where the broadcast waves are too strong or too weak. In such cases, carry out presetting manually. (➔ Page 23.)

A

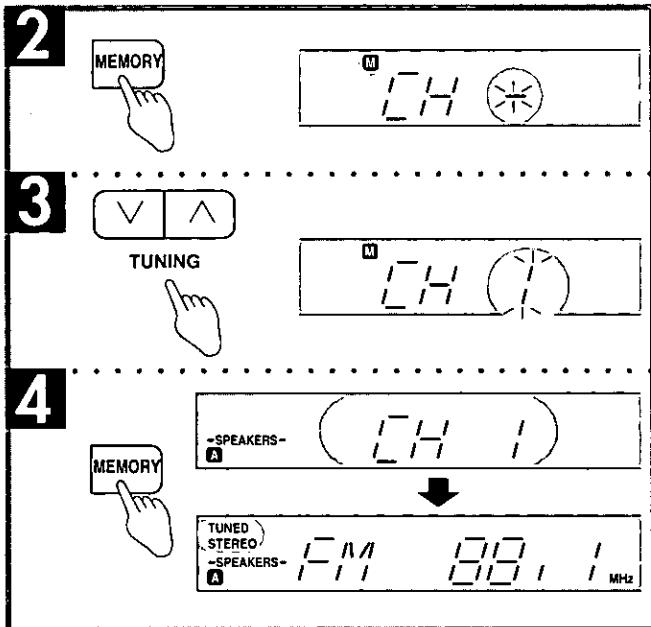
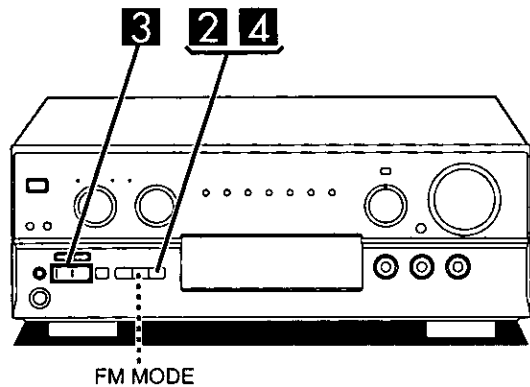

B

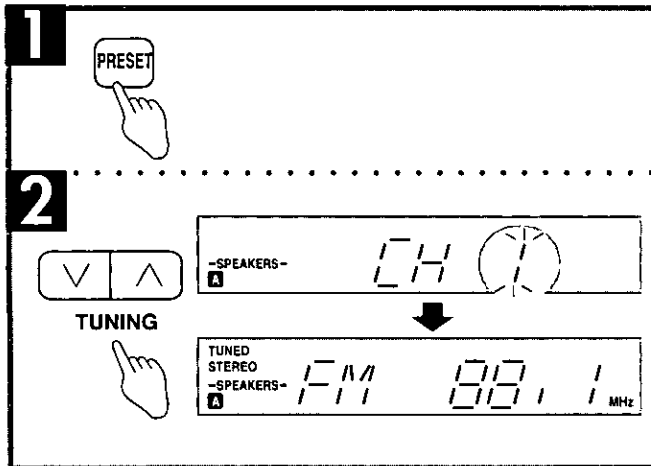
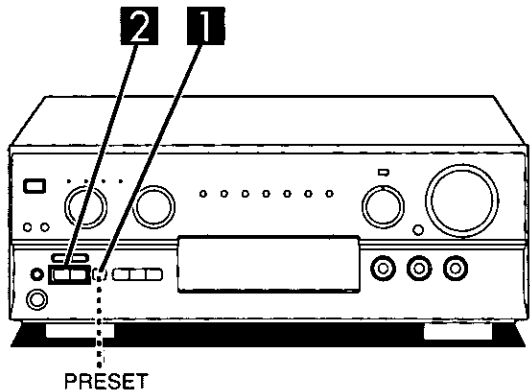

Manual memory presetting A

The desired stations can be preset into the desired channels by the user.

1 Set to the desired frequency.
(→ Page 20–21.)

If interference or static is keeping you from enjoying an FM broadcast, press [FM MODE] and change to monaural. You can preset the station in monaural just as in stereo.

2 Press [MEMORY].
To cancel the memory function, press [MEMORY] again.

3 Press [TUNING (∨ or ∧)] to select the desired channel.
Holding the buttons down lets you scroll through channels faster.

4 Press [MEMORY].
The channel will blink on the display.

To continue presetting
Repeat steps 1 through 4.

To listen to preset channels E

1 Press [PRESET].

2 Press [TUNING (∨ or ∧)].
Holding down the buttons lets you scroll through channels faster.

The channel number will be changed for approximately 5 seconds. Select the desired channel number during that time. After 5 seconds, the display will change from the channel number to the frequency.

Note

If you press [PRESET] while the channel number is displayed, the display will change to the frequency.

To confirm the channel number of the broadcast station being received

Press [PRESET].
(The channel number flashes for approximately 5 second.)

Note

The channel number is not displayed if you change the frequency or FM mode setting.

For your reference

Even if the power cord is disconnected from the household AC outlet, the memory will retain its contents for approximately one month.

If frequency presettings are accidentally erased

Program the presettings once again.
The power cord should remain connected for one hour or more for the memory back-up to be effective.

You can take advantage of the following modes with this unit.

STEREO mode

Use this mode when you want to listen to stereo sources, whether they are digital or analog, or when you want to playback Dolby Digital or DTS sources through two channels. The sounds usually fed through the other speakers are down-mixed so they are output through the left and right front speakers. There may be some change in the overall sound when surround sources are down-mixed.

SURROUND mode

By selecting this mode while digital input is being used, the unit automatically determines the kind of digital source being used (Dolby Digital, Dolby Surround, or DTS), and processes it accordingly. Select this mode also when you are playing back an analog source, VCR for example, that has been recorded in Dolby Surround.

Software with the following mark can be played back in this mode.

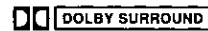

DTS mode

Select this mode if the DTS source you are playing back is not recognized by the SURROUND mode.

Software with the following mark can be played back in this mode.

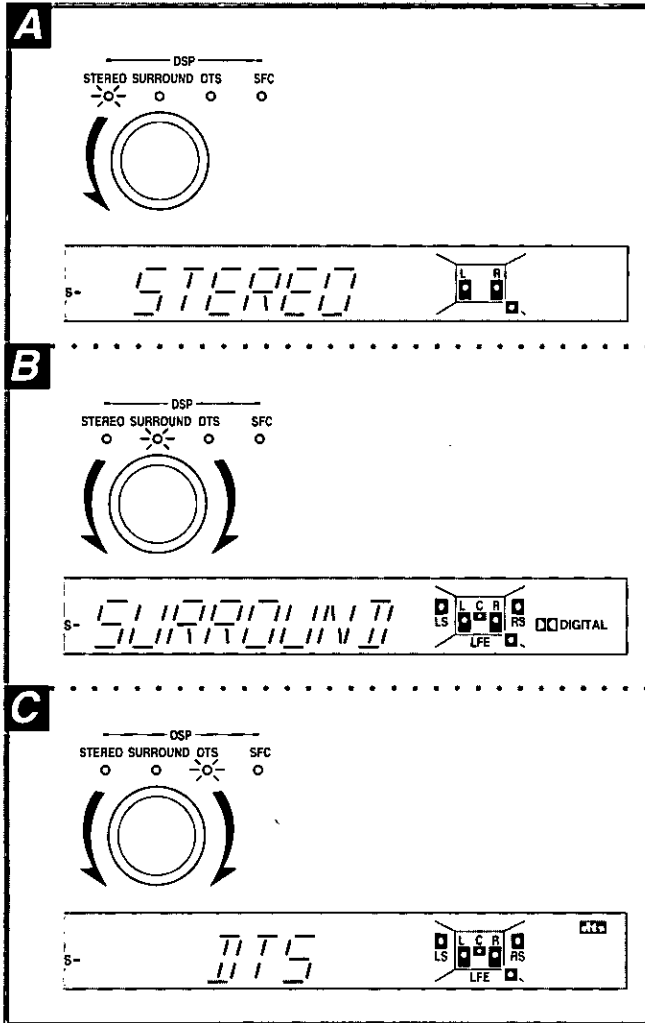
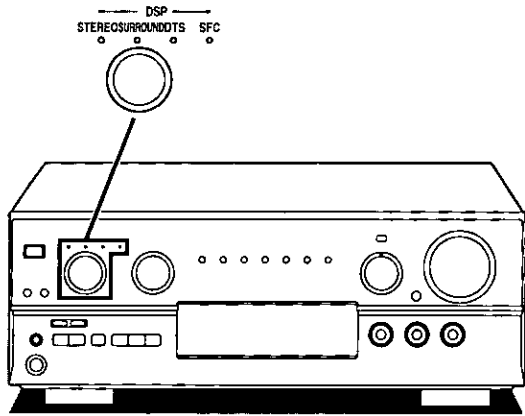

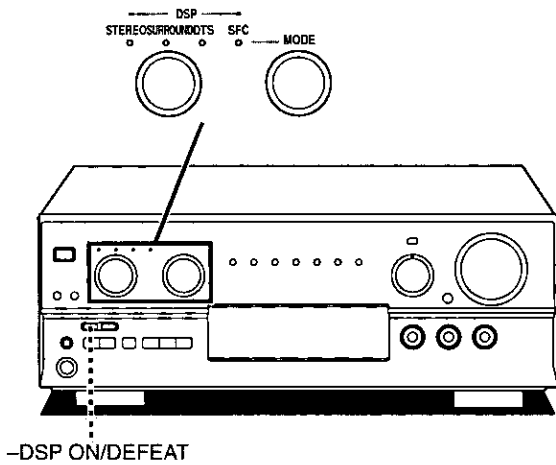

SFC mode

The SFC (Sound Field Control) function gives presence and spread thereby enhancing and enriching the music or movie. Read the following explanations better understand how to make your selection.

Note

SFC is designed to add surround-like effects to stereo sources. Select the appropriate mode when playing back Dolby Digital, DTS, or Dolby Surround sources.

HALL

This mode imparts a reflection and spread which will make you feel as if you are in a large concert hall.

CLUB

Like a jazz club, this mode provides an exciting and intimate atmosphere. It simulates the sound field of a relatively small room having a low ceiling and hard reflective surfaces, for a "live" sound with enhanced presence to bring the performers up close.

LIVE

Primarily for vocal pieces, this mode adds gloss to the vocals and you'll feel as though you were hearing a live stage performance.

THEATER

You can clearly perceive the directions and source of the movie. Real ambience of sound can also be recreated naturally using this mode.

SIMULATED (SIM SURR)

Choose this mode if little or no sound will be heard from the surround speakers.

You can feel as if you were in a more expanded space adding to the actual sound from the source.

This mode also adds effect to monaural sources by outputting sound from surround speakers.

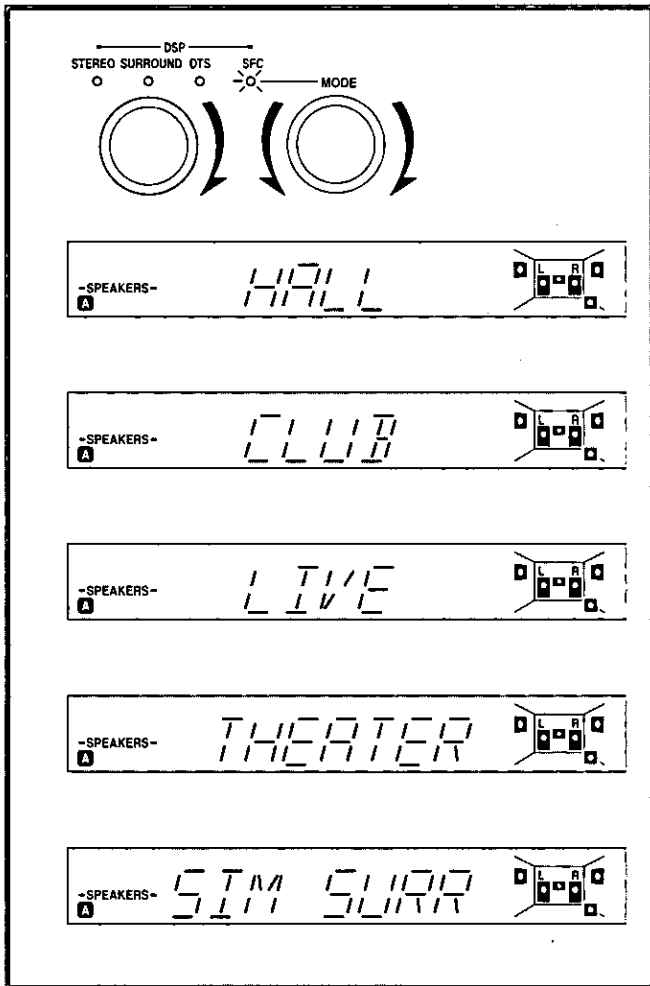

If reception is weak or "TUNED" fails to light completely while playing the radio

Press and hold [-DSP ON/DEFEAT] until "DEFEAT" appears on the display.

Press and hold again to turn DSP on. The STEREO mode is selected.

This allows you to play back sound without it passing through the digital signal processor (DSP). When this is selected, no sound will go through the center or surround speakers or the subwoofer.

Note

When "DEFEAT" is selected the sound mode indicators (STEREO, SURROUND, DTS and SFC) go out and these modes can not be selected.

Preparing for surround sound

Do these steps to get the most from your home theater system.

Adjusting speaker output level

by remote control

Adjust speaker level so the output from all the speakers is the same apparent level when sitting where you would normally enjoy a source.

Preparation

- Turn ON the speakers with [SPEAKERS A].
- Adjust front speaker balance with [BALANCE].

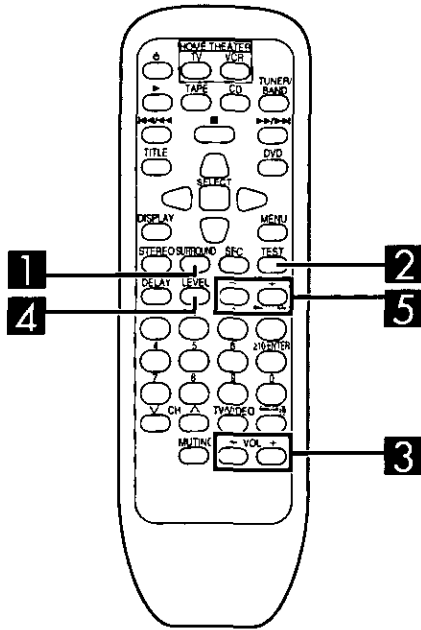

1 Press [SURROUND] to select "SURROUND".
"SURROUND" appears on the display.

2 Press [TEST] to output the test signal.
"TEST" appears on the display.
The signal is output from each speaker in order for about two seconds each:

L: Front speaker (left)
C: Center speaker
R: Front speaker (right)
RS: Surround speaker (right)
LS: Surround speaker (left)
SW: Subwoofer

Speakers set as "NONE" or "OFF" are skipped.

3 Press [VOL (- or +)] to set the volume level normally used for enjoying the source.

4 Press [LEVEL] to select the speaker channel to adjust.
The current level appears on the display.
Press again to change the speaker channel.

Speakers set as "NONE" or "OFF" are skipped.

5 Press [-] or [+] to adjust the level to the same apparent level as the front speakers.
The four channels can be adjusted between -10 dB and +10 dB, with zero being the current level of the front speakers.

- 1** Press [SURROUND] to select "SURROUND".
"SURROUND" appears on the display.

Note

This procedure must be done in the SURROUND mode.

- 2** Press [TEST] to output the test signal.
"TEST" appears on the display.

The signal is output from each speaker in order for about two seconds each:

- L: Front speaker (left)
- C: Center speaker
- R: Front speaker (right)
- RS: Surround speaker (right)
- LS: Surround speaker (left)
- SW: Subwoofer

Speakers set as "NONE" or "OFF" are skipped.

- 3** Press [VOL (- or +)] to set the volume level normally used for enjoying the source.

- 4** Press [LEVEL] to select the speaker channel to adjust.

The current level appears on the display.
Press again to change the speaker channel.

Speakers set as "NONE" or "OFF" are skipped.

- 5** Press [-] or [+] to adjust the level to the same apparent level as the front speakers.

The four channels can be adjusted between -10 dB and +10 dB, with zero being the current level of the front speakers.

- 6** Repeat 4 and 5 for each speaker channel.

To stop the test signal

Press [TEST].

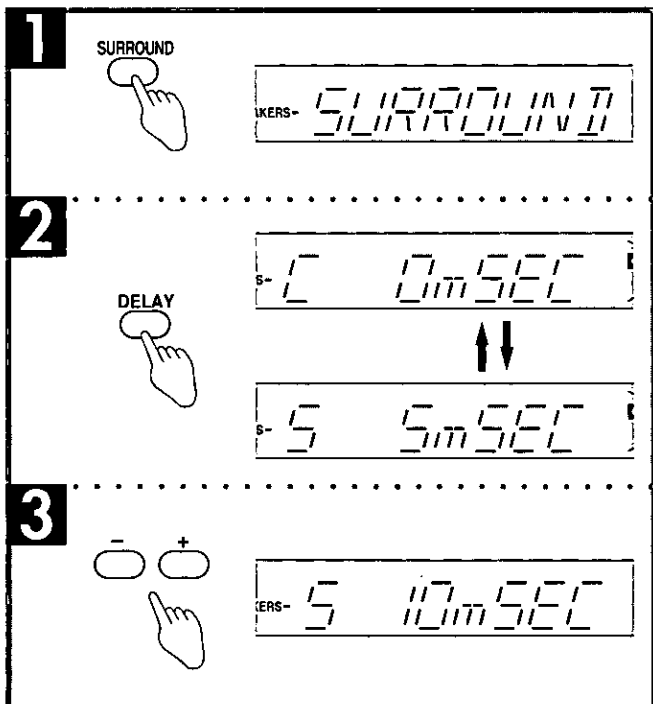
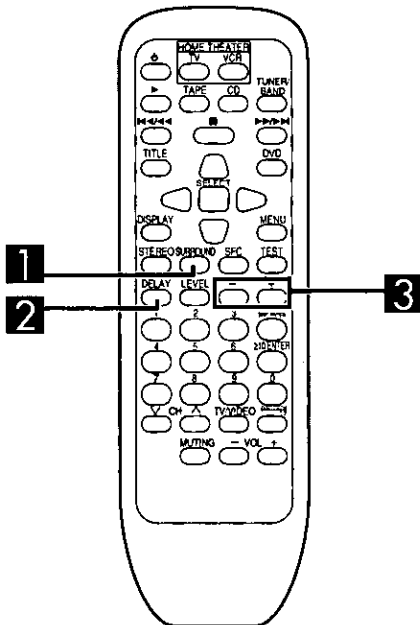

Adjusting the delay time

by remote control only

By adjusting the delay time, the difference in the distance from the viewing and listening position to the front speakers and the distance to the center speaker and surround speakers can be offset and made equal. This achieves better sound localization and makes a more life-like reproduction of the sound field possible.

Preparation

Prepare the unit in this manner even if you intend to playback analog sources.

- Select "DVD" with [INPUT SELECTOR] but ensure the source itself is off.
- Press [DIGITAL INPUT] to select "DIGITAL".

Note

Please note that following occurs if delay time is adjusted while playing back a source or analog input is selected:

- Adjustment is not possible if the source is DTS format.
- While the **PRO LOGIC** indicator is alight, the center channel cannot be adjusted and 15 ms are added to the delay times listed for surround channel.

1 Press [SURROUND] to select "SURROUND".
"SURROUND" appears on the display.

2 Press [DELAY] to select the channel to be adjusted.

The current delay time is displayed.
Press again to change the speaker channel;
C (Center speaker) ⇄ S (Surround speakers)

Speakers set as "NONE" are skipped.

3 Press [-] or [+] to set the delay time.

The delay time changes with each press.
The increments depend on the channel being adjusted.

Speaker	Available delay time setting (ms)
Center	0, 1, 2, 3, 4, 5
Surround	0, 5, 10, 15

➔ See page 28 for information about delay time.

The display is restored if a button isn't pressed for 4 or more seconds.

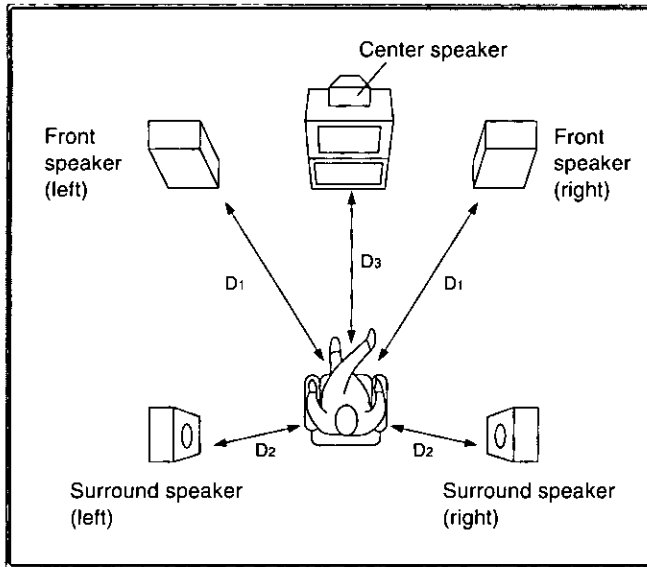

To calculate the delay time

- D1: Distance from front speakers
- D2: Distance from surround speakers
- D3: Distance from center speaker

Setting the center channel delay time:

If D_1 is equal to or less than D_3	Set to 0 ms
If D_3 less than D_1	Increase 1 ms for every 30 cm (1 foot) of difference between D_1 and D_3

Setting the surround channel delay time:

If D_1 is equal to or less than D_2	Set to 0 ms
If D_2 is less than D_1	Start at 0 ms and increase by 5 ms for every 1.5 m (5 feet) of difference between D_1 and D_2

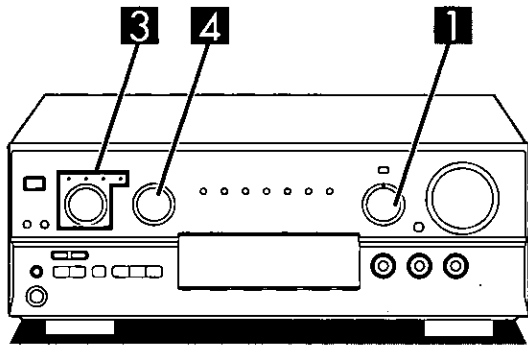

1 Turn [INPUT SELECTOR] to select the desired source.

2 Start the desired source.

3 Turn the sound mode selector to select the desired mode.

The selected reproduction mode appears on the display.

(→ Page 24-25 for descriptions of the mode.)

STEREO: STEREO

SURROUND: SURROUND

One of the following indicators lights to indicate the source.

- (a) **PRO LOGIC:** Lights if the source is Dolby Surround format.
- (b) **DTS:** Lights if the source is DTS format.
- (c) **DIGITAL:** Lights if the source is Dolby Digital Format.

DTS: DTS

SFC: HALL, CLUB, LIVE, THEATER or SIM SURR

Note

Select the mode to suit the source's format. Dolby Digital and DTS, for example, cannot be played back in an SFC mode. If either or appear while using SFC, use SURROUND instead.

4 (only if you select SFC in the above step)

Turn [MODE] to select the desired SFC mode.

1 INPUT SELECTOR

3

DSP
STEREO SURROUND DTS SFC

ERS- STEREO

(a)

ERS- SURROUND

(b)

ERS- SURROUND

(c)

ERS- SURROUND

ERS- DTS

ERS- HALL

4

DSP
STEREO SURROUND DTS SFC MODE

ERS- CLUB

Selected mode

For your reference

You can set the sound mode for each source. Each source will retain the selected mode.

Note

Ensure the front speakers are connected to the A terminals when you use SURROUND, DTS and SFC modes. The SURROUND, DTS and SFC modes cannot be turned on if "SPEAKERS B" is selected.

Only Dolby Digital, DTS or PCM signals* can be reproduced through the digital terminal:

- The digital input signal of sampling frequencies 96 kHz and other signal formats such as MPEG cannot be reproduced on this unit.
- When playback is started, the sound may be cut or interrupted before the input source is confirmed as Dolby Digital or DTS.

* PCM signal: This refers to the recording format of signals (44.1 kHz, linear 16 bits) used for audio CDs.

A

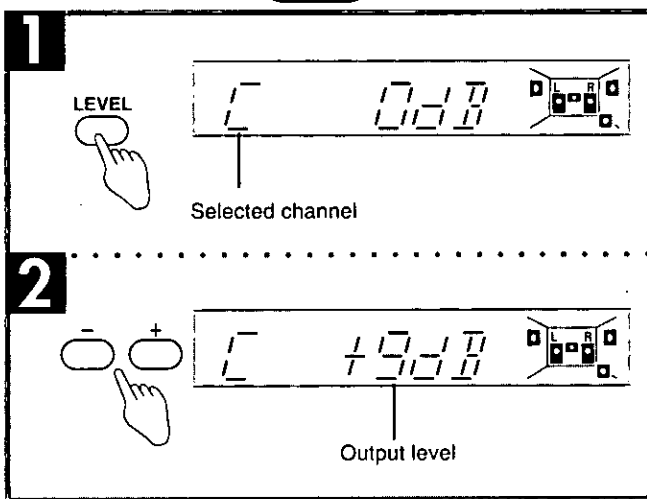
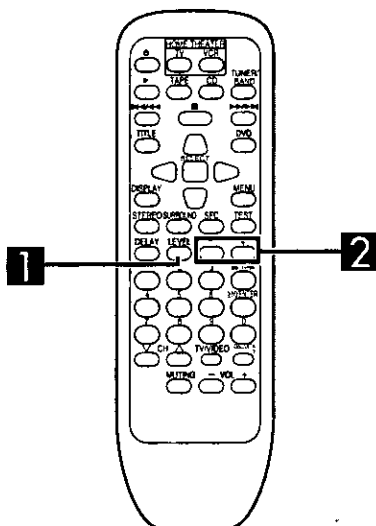

B

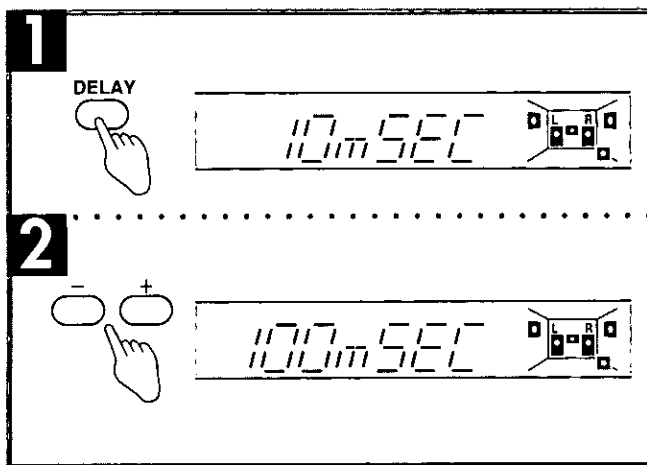
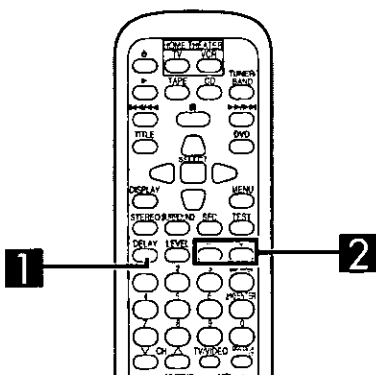

Adjusting field of sound in the SFC mode

by remote control only

With this unit, you can adjust speaker volume.
Adjust the field of sound while listening to a source.

To adjust the volume of each speakers **A**

1 Press [LEVEL] to select the speaker channel to adjust.

The output level appears on the display.

Each time the button is subsequently pressed, the speaker whose level is to be set is selected in the listed sequence.

C → RS → LS → SW

Speakers for which "NONE" or "OFF" has been set are skipped.

2 Press [-] or [+] to adjust the output level.

Channels C, RS, LS, and SW can be adjusted between -10 dB and +10 dB.

To adjust the delay time of the surround speakers **B**

1 Press [DELAY].

2 Press [-] or [+] to adjust the delay time.

Select a delay time to suit your individual needs.

Delay time can be set at 10 milliseconds (ms) intervals between 10 and 100 ms.

The factory settings for each mode are 50 ms.

For your reference

Settings for volume level and delay time can be done for each SFC mode.

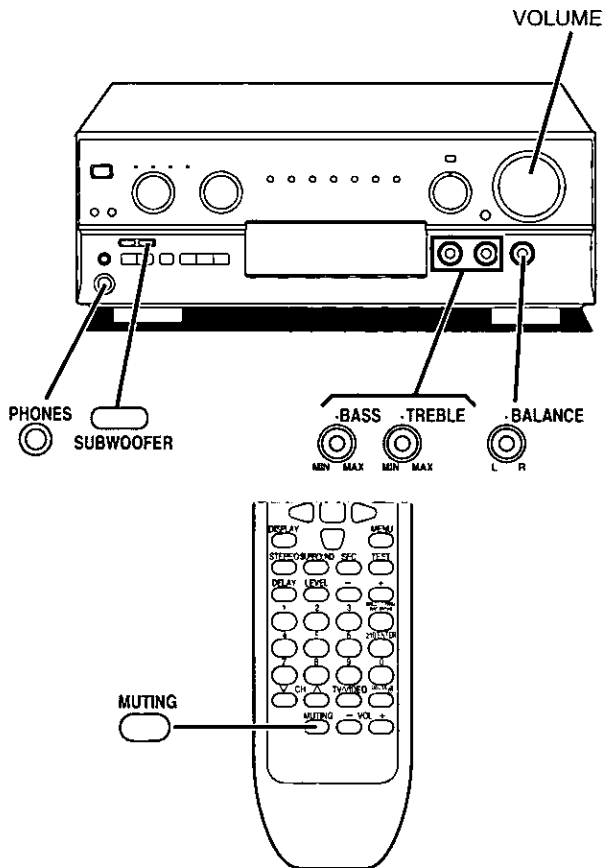

To adjust the tone quality A

Turn [BASS] to adjust the low frequency sound.
Turn [TREBLE] to adjust the high frequency sound.

To adjust the sound balance B

Turn [BALANCE] to adjust the left/right sound balance.

To mute the sound level C

by remote control only

Press [MUTING].

The message "MUTING ON NOW" runs repeatedly from right to left across the display as long as the muting function is on.

Press once again to return to the previous volume level.

Note

Muting is cancelled when the receiver is turned off.

To listen through headphones D

- ① Reduce the volume level.
- ② Connect the headphones.
Plug type: 6.3 mm (1/4 in.) stereo
- ③ Adjust the volume level.

Select STEREO or turn speakers A and B off when using headphones. Turning the speakers off automatically engages STEREO mode and ensures no sound is heard from the subwoofer. If either SURROUND or DTS is used, the sound heard through the headphones will seem unusual.

Note

Avoid listening for prolonged periods of time to prevent hearing damage.

Turning the subwoofer off E

You can turn the subwoofer off when you want to listen to music in stereo.

Press [SUBWOOFER] to select "OFF".
(➔ Page 17.)

You can also adjust the volume of the subwoofer to suit the source you are using.
(➔ Page 26 for details.)

A

B

C

D

E

Sound modes, Others

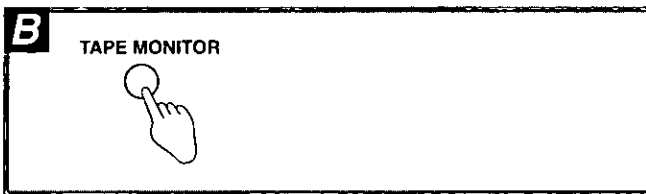
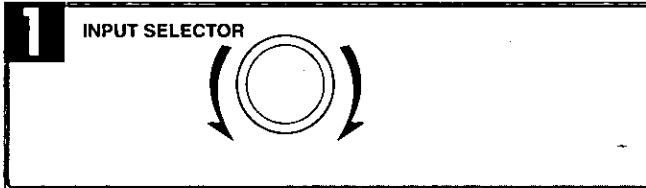
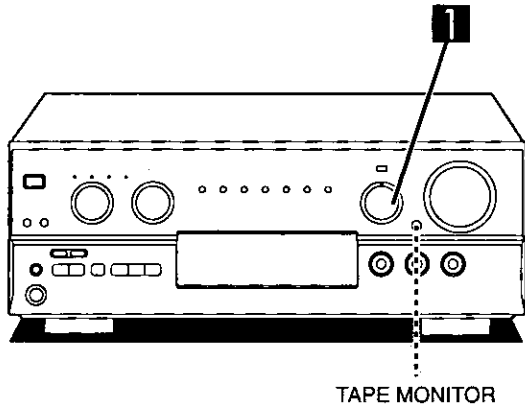
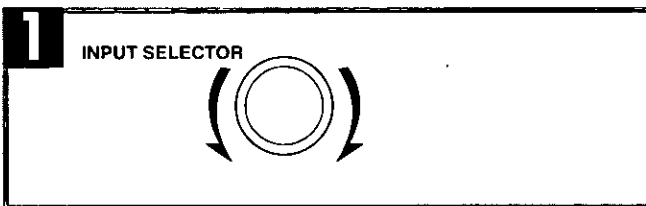
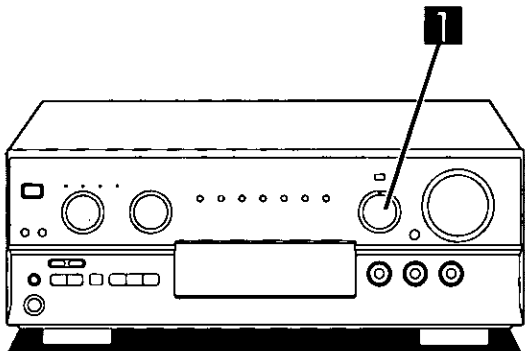
A**C****Note**

You cannot record a source connected through a digital terminal.

Recording on a tape deck**A**

Before recording, prepare the tape deck.
See the tape deck's operating instructions for details.

1 Turn [INPUT SELECTOR] to select the source to be recorded.

Any source can be selected except TAPE.

2 Begin recording on the tape deck.
Follow your tape deck's operating instructions.

3 Begin the source to be recorded.
Follow your equipment's operating instructions.

To monitor the recorded sound**B**

It is possible to check the sound being recorded if your tape deck is a 3 head system.

Press [TAPE MONITOR] on this unit and set the monitor button on the tape deck to "TAPE".

Press [TAPE MONITOR] once again to turn it off.

Recording on a VCR**C**

Before recording, prepare VCR.
See the VCR's operating instructions for details.

1 Turn [INPUT SELECTOR] to select the source to be recorded.

Any source can be selected except VCR and TAPE.

Note

Recording from the tape deck is not possible.

2 Begin recording on the VCR.
Follow your VCR's operating instructions.

3 Begin the source to be recorded.
Follow your equipment's operating instructions.

To operate the receiver

Point the remote control toward the receiver

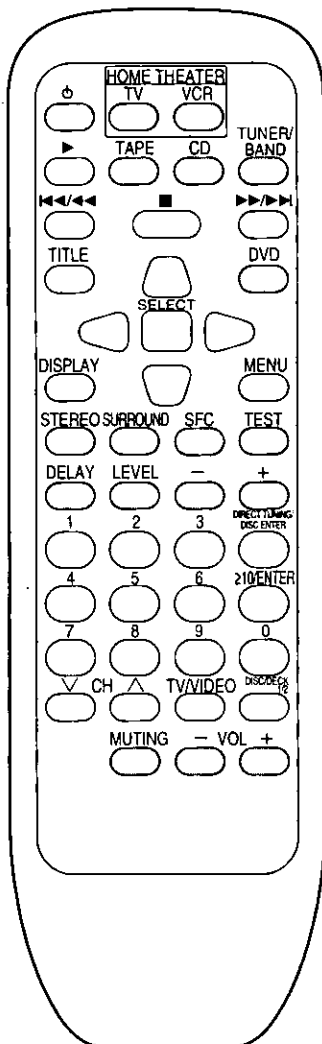

Basic operations

To turn the unit ON/OFF

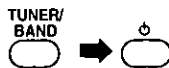

Once the unit has been set to ON, it can be turned ON and OFF simply by pressing [⏻].

Note

After turning the TV, VCR or DVD player ON or OFF, always press [TUNER/BAND] before pressing [⏻] when turning the receiver ON and OFF.

To select an input source and switch the remote control to each operation mode

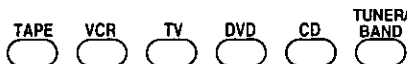

Note

- PHONO can not be selected with this remote control.
- TAPE MONITOR cannot be controlled with the [TAPE] button.

To turn on the STEREO mode



To turn on the SURROUND mode



To turn SFC on and select the mode



Changes as follows each time the button is pressed.

HALL → CLUB → LIVE → THEATER
└── SIM SURR (SIMULATED) ─┘

To output a test signal



When the SURROUND mode is on

Press once more to stop the test signal.

To select the speaker channel and adjust its output level



Note

The last channel to be adjusted is remembered so you can adjust it again without having to press [LEVEL].

To select the speaker channel and adjust its delay time



Note

The last channel to be adjusted is remembered so you can adjust it again without having to press [DELAY].

To mute the sound level







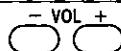

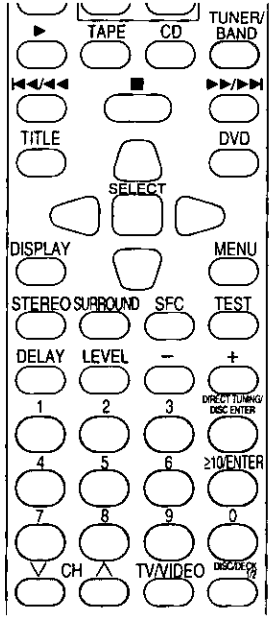

The message "MUTING ON NOW" runs repeatedly from right to left across the display as long as the muting function is on. Press once more to return to the original volume.

To adjust the volume level

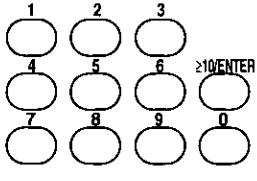

To operate the receiver (continued)

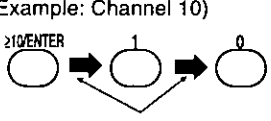
Make sure the remote control is in the tuner operation mode. (⇒ Page 33.)

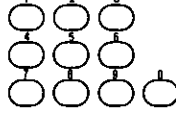
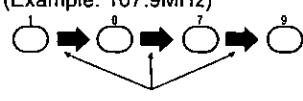





<p>Point the remote control toward the receiver</p>  	<p>To listen to radio broadcasts</p>	
	<p>To select "FM" or "AM"</p>	<p>TUNER/BAND </p> <p>Change as follows each time the button is pressed. FM ⇌ AM</p>
	<p>To select the desired channel sequentially (Preset tuning)</p>	<p> CH </p>
<p>To select the desired channel directly (Preset tuning)</p>	<p></p> <p>(Example: Channel 1) </p> <p>(Example: Channel 10) </p> <p>≥10/ENTER is ≥10 on SA-DX830 within 10 seconds</p>	
<p>To select radio stations by frequency (Direct tuning)</p>	<p> → </p> <p>(Example: 107.9MHz) </p> <p>within 10 seconds</p>	

To operate a cassette deck

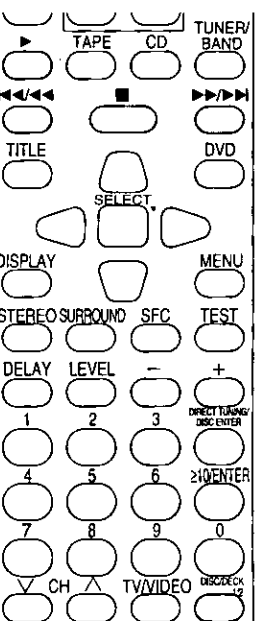
Turn the cassette deck ON before trying to operate it by remote control.











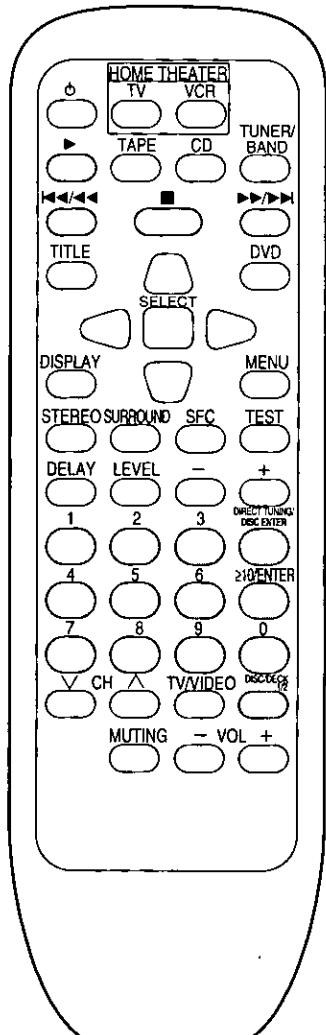

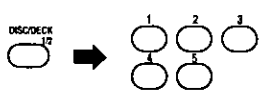
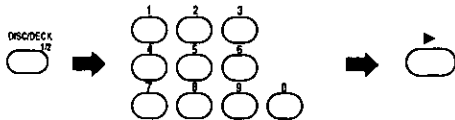

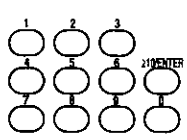



Make sure the remote control is in the cassette deck operation mode. (⇒ Page 33.)

It may not be possible to operate some cassette decks with this unit.

<p>Point the remote control toward the cassette deck</p>  	<p>Only when using a double cassette deck</p> <p>To select the tape deck (DECK 1/DECK 2)</p>	<p>DISCDECK 1/2 </p>
	<p>To start playback</p>	<p></p>
	<p>To fast-forward or rewind the tape</p>	<p>While the tape is stopped</p> <p> </p> <p>With TPS-equipped cassette decks, you can move to the beginning or end of a track by pressing these buttons while the tape is playing.</p>
	<p>To stop playback</p>	<p></p>

To operate a CD changer or CD player

Turn the CD changer (or CD player) ON before trying to operate it by remote control.
 Make sure the remote control is in the CD player operation mode. (➔ Page 33.)
 It may not be possible to operate some CD players with this unit.

<p>Point the remote control toward the CD changer (or CD player)</p>  	<p>To start play</p> 		
	<p>To start play from the desired disc</p>	<p>For 5 CD changer</p>  <p>Select disc number.</p>	<p>For MEGA CD changer ※</p>  <p>Select the disc number. (When selecting discs, [≥10/ENTER] does not respond to touch.) ≥10/ENTER is ≥10 on SA-DX830.</p> <p>For your reference</p>  <p>If you press this button instead of [▶] shown in the above procedure, the CD changer will stop and display the disc number. To start the disc, press [▶].</p>
	<p>To start play from the desired track</p>	 <p>Select the track number. (Example: Track 1)  (Example: Track 10)  →  → </p> <p>≥10/ENTER is ≥10 on SA-DX830.</p>	<p>Select the track number. (Example: Track 1)  (Example: Track 10)  →  → </p>
	<p>To skip a track</p>	 	 
<p>To stop play</p>			

※ "MEGA CD changer" means any Technics CD changer that takes more than 50 discs.

Remote control operations

The procedures below are examples for when a TV and VCR are connected to the receiver as shown in this manual. This remote control transmitter is designed for use with a home theater system. If you press [TV] (or [VCR]) and [⏻] in succession, the TV (or VCR) and receiver will be turned on and the selector on the receiver will change to TV/DSS (or VCR). Press [⏻] within 3 seconds of pressing [TV] (or [VCR]).

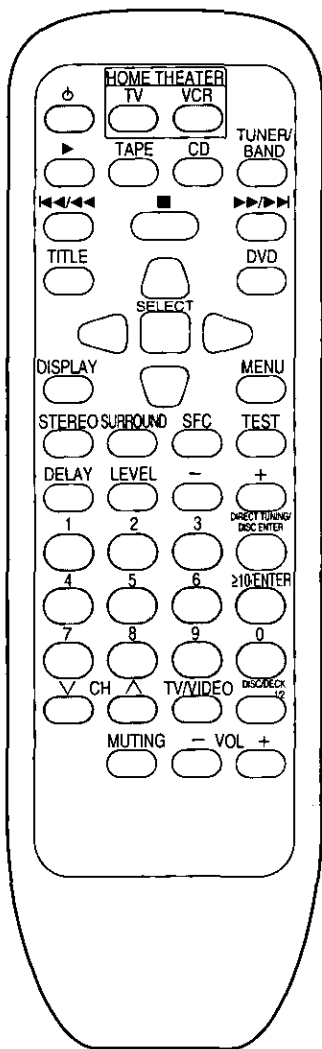

To watch TV broadcasts

Point the remote control toward the TV and the receiver



Switch ON the TV and the receiver.

The receiver will switch to TV/DSS input.

Point the remote control toward the TV



Set the TV/VIDEO mode on the TV to "TV".

Point the remote control toward the TV

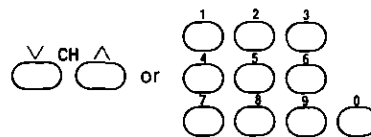

Select the desired channel.

Note

If you allow more than 3 seconds to pass between pressing [TV] and [⏻], only the TV will be operated.

Do not use this remote control to turn the TV ON and OFF if you are not using the receiver.

To watch TV broadcasts with a VCR tuner

Point the remote control toward the TV and the receiver



Switch ON the TV and the receiver.

Point the remote control toward the VCR and the receiver



Switch ON the VCR.

The receiver will switch to VCR input.

Set the input selector on the VCR to the "TUNER" position

Point the remote control toward the VCR

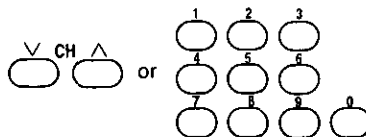

Select the desired channel.

Point the remote control toward the TV



Set the TV/VIDEO mode on the TV to "VIDEO".

Note

If you allow more than 3 seconds to pass between pressing [VCR] and [⏻], only the VCR will be operated.

Do not use this remote control to turn the VCR ON and OFF if you are not using the receiver.

To switch OFF the TV



To switch OFF the VCR



Note

Turn the receiver OFF last.



SA-DX930 only

This button is used when using ENTER to select a channel on a TV or VCR which has not been manufactured by this company.

To watch video tapes

The procedures below are examples for when a TV and VCR are connected to the receiver as shown in this manual.

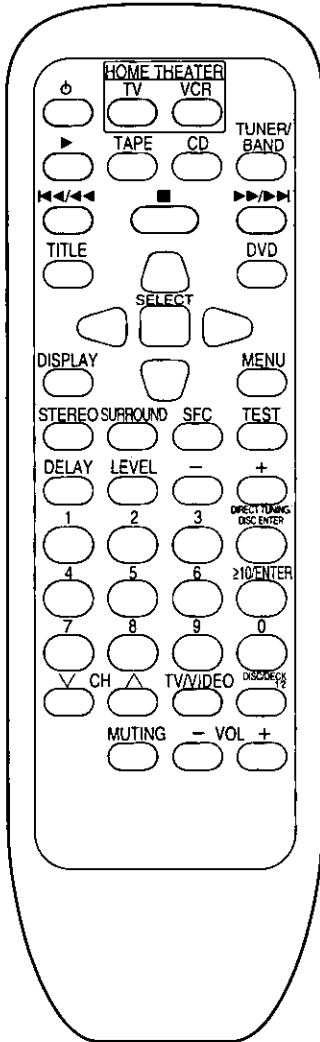

To watch video tapes

Point the remote control toward the TV and the receiver

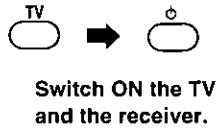

Point the remote control toward the VCR player and the receiver

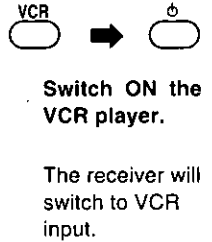

Point the remote control toward the TV

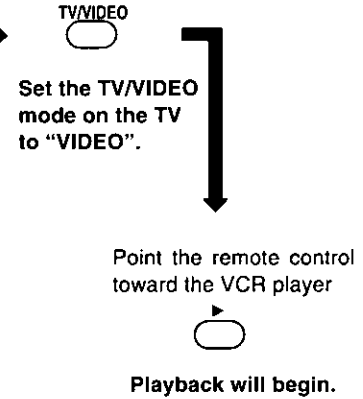

To fast-forward or rewind the video tape

In the stop mode



To stop playback



To switch OFF the TV



To switch OFF the VCR



Note

Turn the receiver OFF last.

To operate a DVD player

The procedures below are examples for when a TV and DVD player are connected to the receiver as shown in this manual. Make sure the remote control is in the DVD player operation mode. (→ Page 33.) Actual operations depend on your equipment and software.

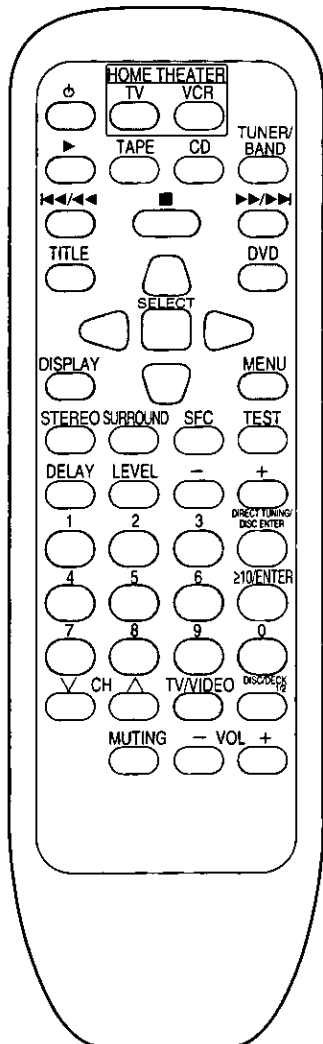

To watch DVDs

Point the remote control toward the TV and the receiver



Switch ON the TV and the receiver.

Point the remote control toward the DVD player and receiver



Switch ON the DVD player. The receiver will switch to DVD input.

Point the remote control toward the TV



Set the TV/VIDEO mode on the TV to "VIDEO".

Point the remote control toward the DVD player.



Play will begin.

To select the title

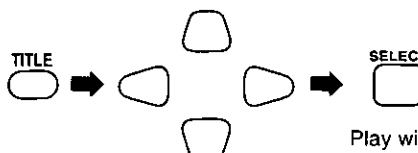

Play will begin.

To use the DVD menu

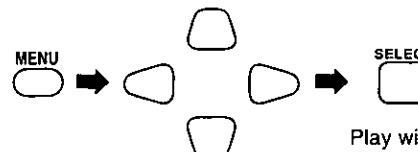

Play will begin.

To clear the DVD menu



To use on-screen graphic controls
(Graphic user interfaces, GUI, are a feature of some DVD players. See your player's manual for details.)

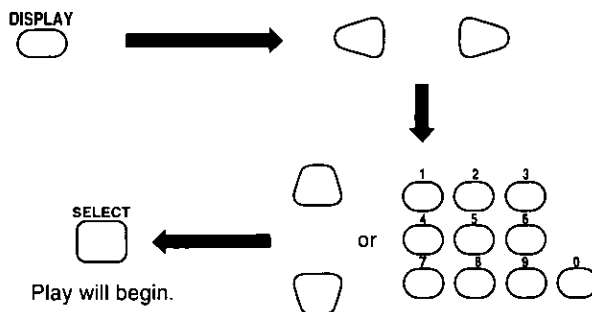

Play will begin.

To skip to the beginning of a track or chapter

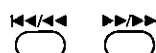

To stop play



To switch OFF the TV



To switch OFF the DVD player



Note

Turn the receiver OFF last.

Changing the remote control code SA-DX930 only

Change the remote control code in either of the following circumstances:

- If the Panasonic TV or VCR does not operate as a result of a difference in the remote control code.
 - If you wish to operate some other make of TV or VCR.
- (⇒ Refer to pages 36 and 37 for the buttons which can be used.)

Note

Even after changing the code there may be cases where certain operations cannot be done or operation is not possible at all.

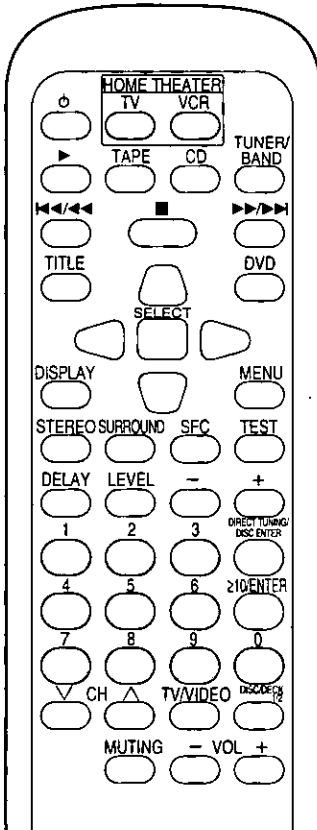

How to change the remote control code

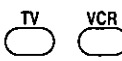

Hold down the button corresponding to the component you wish to operate.

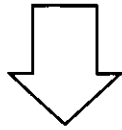

Continue to hold the button down and...

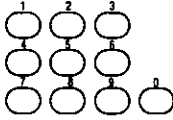

Aim the remote control at the component you wish to operate and carefully and slowly press the numeric buttons to enter the appropriate two-digit code number.

(Refer to the table below for the code number.)

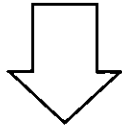

When the two-digit code number is entered, the remote control will automatically output the on/off signal.

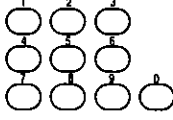

If the remote control has been correctly changed to the code for the component to be operated, the component will be switched ON or OFF.

Note

If there is more than one code number indicated in the code table, repeat the above procedure until you find a code number for which the power of the component is switched ON or OFF.

TV				VCR			
Manufacturer	Code No.	Manufacturer	Code No.	Manufacturer	Code No.	Manufacturer	Code No.
Panasonic	01,02,20	RCA	03,07,09,13,23,24,25	Panasonic	01,02,09,33	Philips	02,09,12
Sony	04			Sony	05,06,07,35,36,37	Pioneer	09
Fisher	14	Sanyo	14	Fisher	13,14,15,18	Quasar	01,02,09,33
G-E	02,03,07,09	Sharp	08,21	Funai	08,30	RCA	02,03,04,09,10,11,12,23,24,26
Gold Star	07,15	Sylvania	06,07,15	G-E	02,03,11	Sanyo	14,18
Hitachi	05,07	Symphonic	17	Gold Star	27	Sharp	16,17
JVC	12	Toshiba	10,21	Hitachi	09,10,11	Shintom	32
LXI	03,06,07,10,14,15	Zenith	18,26	JVC	19,25,31,38,39,40	Sylvania	02,09,12,30
Magnavox	06,07,11,15,22			LXI	10,13,14,15,18,27,30	Symphonic	30
Mitsubishi	07,15,16,21			Magnavox	02,09,12	Toshiba	23,24
NEC	07,15			Mitsubishi	21,22,28,29	Zenith	20
Philco	06,07			NEC	19,25,31,38		
Philips	06			Philco	02,09,12,30		
Pioneer	02,10,19						
Quasar	02						

Note

Changes to the codes are cancelled when the remote control's batteries are replaced. Repeat the above operation to reenter the code.

Before requesting service for this unit, check the chart below for a possible cause of the problem you are experiencing. Some simple checks or a minor adjustment on your part may eliminate the problem and restore proper operation.

If you are in doubt about some of the check points, or if the remedies indicated in the chart do not solve the problem, refer to the directory of Authorized Service Centers (enclosed with this unit) to locate a convenient service center, or consult your dealer for instructions.

For detailed instructions, contact an authorized servicenter in the U.S.A. and Panasonic Canada Inc. Customer Care Centre in Canada.

In the U.S.A. 1-800-211-7262 or web site (<http://www.panasonic.com>)

In Canada 905-624-5505 or web site (www.panasonic.ca/faq.html)

Problem	Probable cause(s)	Suggested remedy	Page(s)
While listening to FM broadcasts			
A hiss is heard during stereo broadcasts, but not during monaural ones.	Modulation for the two types is different so some noise may be heard during stereo broadcasts.	<ul style="list-style-type: none"> • Reduce the treble. • Change the location and direction of the antenna. • Use an outdoor antenna. • Use an antenna with more elements. 	31
			12,13
Excessive noise in both stereo and monaural broadcasts.	Antenna location and direction poor.	<ul style="list-style-type: none"> • Select "DSP DEFEAT". 	13
	Station is distant.		–
	DSP is on.		25
STEREO and TUNED indicators flicker.	Antenna location and direction poor.	<ul style="list-style-type: none"> • Change the location and direction of the antenna. • Use an outdoor antenna. • Use an antenna with more elements. 	12,13
	Station is distant.		13
Stereo broadcasts highly distorted.	Building or mountain nearby.	<ul style="list-style-type: none"> • Use an antenna with more elements. 	–

While listening to AM broadcasts			
An unusual "beat" sound is heard.	A television is on nearby.	• Separate the two or turn the television off.	–
	Adjacent signal is interfering.	• Reduce the treble.	31
	DSP is on.	• Select "DSP DEFEAT".	25
A low-pitched "hum" is heard when a station is tuned.	Power cord is near the antenna wires.	• Separate the power cord from the wires.	–
	Electronic interference from the power cord is fed to the speakers.	• Use an outdoor antenna.	13
A continuous or intermittent hiss is heard.	Interference from other appliances, fluorescent lights, TVs, small motors, etc., through discharge and oscillation.	• Separate this unit from such appliances.	–

While enjoying the surround modes			
Sound is not heard from the center, surround or subwoofer speakers	The presence setting of the speaker has been incorrectly set to "NONE" or "OFF".	• Set the type and presence setting of each speaker correctly.	16, 17, 31
	The presence mode setting has been incorrectly set to "STEREO".	• Set the SURROUND or DTS reproduction mode.	24
A DTS formatted source cannot be played back in the SURROUND mode.	This DTS source couldn't be processed by the SURROUND mode.	• Select the DTS reproduction mode.	24
SURROUND, DTS, and SFC cannot be selected.	DSP is off.	• Select "DSP ON".	25

Problem	Probable cause(s)	Suggested remedy	Page(s)
Common Problems			
Unit doesn't come on.	The power cord plug is not fully inserted.	• Confirm the plug is fully inserted.	–
Sound is not heard.	The speaker indicators are off.	• Turn on the speaker indicators.	18
	The tape monitor function is on.	• Press the tape monitor button.	19
	The muting function is on.	• Press the muting button on the remote control.	31
	Incomplete or incorrect connection to speakers and external equipment.	• Check all connections.	9–11, 14–15
	The incorrect input source has been selected.	• Select the correct source.	18
Sound suddenly stops or none is heard when the unit is switched on. "OVERLOAD" appears on the display.	The protection circuitry has functioned because: the positive and negative speakers wires have shorted; speakers with a lower impedance than this unit's rated impedance are being used; the speakers are under strain through excessive volume, excessive power, or by being used in a high temperature environment.	• Switch off the unit, determine and correct the cause, then switch the unit on. • Use speakers with the right impedance rating.	– 14–15
"F70" appears on the display.		• Turn off the power and then turn it on again, or disconnect the AC power supply cord and then connect it to your household AC outlet again. (If "F70" still remains on the display, consult an authorized service center or your dealer.)	–

About the HELP function

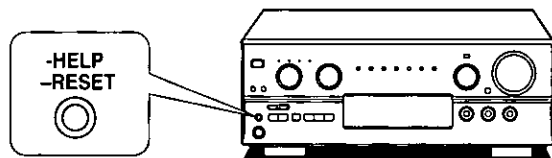

If you make a mistake in operation or if sound output stops due to some operation which was performed, the HELP function displays information which can be useful for indicating the method by which this condition can be remedied.

If "ERROR" or scrolling characters (for instance, "SPEAKER OFF NOW") appear on the display during operation, carry out the following operation.

Press [-HELP, -RESET].

The method for remedying this situation will be displayed.

For your reference

If the above button is pressed for 2 seconds or more until "RESET" appears on the display, the operation settings for the unit will be initialized to the settings made at the time of shipment. However, any broadcasting stations which have been preset into memory will not be erased at this time.

■ AMPLIFIER SECTION

Rated minimum sine wave RMS power output	
20 Hz–20 kHz both channels driven	100 W per channel (8 Ω)
0.05 % total harmonic distortion	
1 kHz continuous power output both channels driven	
0.05 % total harmonic distortion	105 W per channel (8 Ω)
Total harmonic distortion	
rated power at 20 Hz–20 kHz	0.05 % (8 Ω)
half power at 1 kHz	0.03 % (8 Ω)
Power output at the Dolby Pro Logic operation	
0.9 % at 1 kHz,	
Front	2 x 100 W (8 Ω)
Center	100 W (8 Ω)
Surround	2 x 100 W (8 Ω)
Low frequency damping factor	
Load impedance	30 (8 Ω)
Front	
A or B	4–8 Ω
A and B	8 Ω
Center	8 Ω
Surround	8 Ω
Dynamic headroom	
	2 dB (8 Ω)
Frequency response	
PHONO	RIAA standard curve ±0.8 dB
CD, TAPE, DVD, VCR, TV/DSS	10 Hz–70 kHz, ±3 dB
Input sensitivity	
PHONO	0.4 mV (3 mV, IHF '66)
CD, TAPE, DVD, VCR, TV/DSS	27 mV (200 mV, IHF '66)
S/N (IHF A)	
PHONO	70 dB (80 dB, IHF '66)
CD, TAPE, DVD, VCR, TV/DSS	75 dB (85 dB, IHF '66)
Input impedance	
PHONO	47 kΩ
CD, TAPE, DVD, VCR, TV/DSS	22 kΩ
Tone controls	
BASS	50 Hz, +10 to –10 dB
TREBLE	20 kHz, +10 to –10 dB
Subwoofer frequency response	
	7–100 Hz, ±3 dB

Digital input	
Optical	CD, TV/DSS
Coaxial (Input impedance 75 Ω)	DVD

■ FM TUNER SECTION

Frequency range	87.9–107.9 MHz
Sensitivity	11.2 dBf (2 μV, IHF '58)
50 dB quieting sensitivity	
MONO	18.3 dBf (4.5 μV, IHF '58)
STEREO	38.3 dBf (45 μV, IHF '58)
Total harmonic distortion	
MONO	0.2 %
STEREO	0.3 %
S/N	
MONO	73 dB
STEREO	67 dB
Frequency response	20 Hz–15 kHz, +1 dB, –2 dB
Alternate channel selectivity	65 dB
Capture ratio	1.5 dB
Image rejection at 98 MHz	40 dB
Spurious response rejection at 98 MHz	75 dB
AM suppression	50 dB
Stereo separation	
1 kHz	40 dB
10 kHz	30 dB
Antenna terminal	75 Ω (unbalanced)

■ AM TUNER SECTION

Frequency range	530–1710 kHz
Sensitivity	20 μV, 330 μV/m
Selectivity	55 dB
IF rejection at 1000 kHz	50 dB

■ VIDEO SECTION

Output voltage at 1 V input (unbalanced)	1±0.1 Vp-p
Maximum input voltage	1.5 Vp-p
Input/output impedance	75 Ω

■ GENERAL

Power supply	AC 120 V, 60 Hz
Power consumption	380 VA, 290 W
Dimensions (W x H x D)	430 x 158.2 x 320.5 mm (16-15/16" x 6-7/32" x 12-5/8")
Weight	9.6 kg (21.3 lb.)

Power consumption in standby mode 1 W

Notes:

- Specifications are subject to change without notice.
Weight and dimensions are approximate.
- Total harmonic distortion is measured by the digital spectrum analyzer.

Listening caution



Selecting fine audio equipment such as the unit you've just purchased is only the start of your musical enjoyment. Now it's time to consider how you can maximize the fun and excitement your equipment offers. This manufacturer and the Electronic Industries Association's Consumer Electronics Group want you to get the most out of your equipment by playing it at a safe level. One that lets the sound come through loud and clear without annoying blaring or distortion—and, most importantly, without affecting your sensitive hearing.

We recommend you to avoid prolonged exposure to excessive noise.

Sound can be deceiving. Over time your hearing "comfort level" adapts to higher volumes of sound. So what sounds "normal" can actually be loud and harmful to your hearing.

Guard against this by setting your equipment at a safe level BEFORE your hearing adapts.

To establish a safe level:

- Start your volume control at a low setting.
- Slowly increase the sound until you can hear it comfortably and clearly, and without distortion.

Once you have established a comfortable sound level:

- Set the dial and leave it there.

Taking a minute to do this now will help to prevent hearing damage or loss in the future. After all, we want you listening for a lifetime.

Maintenance

If the surfaces are dirty

To clean this unit, wipe with a soft, dry cloth.

If the surfaces are extremely dirty, use a soft cloth dipped in a soap-and-water solution or a weak detergent solution.

- Never use alcohol, paint thinner or benzene to clean this unit.
- Before using chemically impregnated cloth, read the instructions that came with the cloth carefully.

Product service

Do not attempt to remove the cover(s) or repair the unit yourself. Refer servicing to qualified personnel only.

Product information

For product service, product information or assistance with product operation, refer to the servicenter directory.

**Panasonic Consumer Electronics
Company, Division of Matsushita
Electric Corporation of America**
One Panasonic Way Secaucus,
New Jersey 07094
<http://www.panasonic.com>

**Panasonic Sales Company,
Division of Matsushita Electric of
Puerto Rico, Inc. ("PSC")**
Ave. 65 de Infantería. Km. 9.5
San Gabriel Industrial Park, Carolina,
Puerto Rico 00985

Panasonic Canada Inc.
5770 Ambler Drive,
Mississauga, Ontario
L4W 2T3
www.panasonic.ca



RQT4918-P

H0199V0