

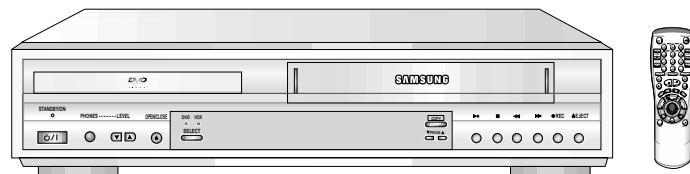



**DVD-VCR**

**SV-DVD1E**

# Instruction Manual



Safety Precautions



**CAUTION**

RISK OF ELECTRIC SHOCK  
DO NOT OPEN



**CAUTION. TO REDUCE THE RISK OF ELECTRIC SHOCK, DO NOT REMOVE REAR COVER. NO USER SERVICEABLE PARTS INSIDE. REFER TO QUALIFIED SERVICE PERSONNEL.**



DANGER

This symbol is intended to alert you to the presence of dangerous voltage within the product.

**IMPORTANT NOTE**

The mains lead on this equipment is supplied with a moulded plug incorporating a fuse. The value of the fuse is indicated on the pin face of the plug. If it requires replacing, a fuse approved to BS1362 of the same rating must be used.

Never use the plug with the fuse cover omitted if the cover is detachable. If a replacement fuse cover is required, it must be of the same colour as the pin face of the plug. Replacement covers are available from your dealer.

If the fitted plug is not suitable for the power points in your house or the cable is not long enough to reach a power point, you should obtain a suitable safety approved extension lead or consult your dealer for assistance.

However, if there is no alternative to cutting off the plug, remove the fuse and then safely dispose of the plug. Do not connect the plug to a mains socket, as there is a risk of shock hazard from the bared flexible cord.

**IMPORTANT**

The wires in the mains lead are coloured in accordance with the following code: -

BLUE = NEUTRAL      BROWN = LIVE

As these colours may not correspond with the coloured markings identifying the terminals in your plug, proceed as follows: -

The wire coloured BLUE must be connected to the terminal marked with the letter N or coloured BLUE or BLACK. The wire coloured BROWN must be connected to the terminal marked with the letter L or coloured BROWN or RED.

**WARNING: DO NOT CONNECT EITHER WIRE TO THE EARTH TERMINAL WHICH IS MARKED WITH THE LETTER E OR BY THE EARTH SYMBOL , OR COLOURED GREEN OR GREEN AND YELLOW.**



CAUTION

This symbol is intended to alert you to the presence of important instructions accompanying the product.

Contents

- ◆ FOREWORD
  - Safety Instructions ..... 6
- ◆ DVD-VCR OVERVIEWS
  - Front View of the DVD-VCR ..... 7
  - Rear View of the DVD-VCR ..... 7
  - Infrared Remote Control ..... 8
  - Display Indicators ..... 9
  - Accessories ..... 9
- ◆ CONNECTING YOUR DVD-VCR
  - Deciding How to Connect DVD-VCR ..... 10
  - Connecting DVD-VCR to the TV using the Coaxial Cable ..... 11
  - Connecting DVD-VCR to the TV using the SCART Cable ..... 11
  - Connecting DVD-VCR to the Satellite receiver or Other Equipment ..... 12
  - Connecting the Audio Output Cable ..... 13
  - Plug & Auto Set Up ..... 13
  - Tuning Your Television for the DVD-VCR ..... 14
  - Deck Control Keys ..... 15
  - Basic TV Tuner Operations ..... 16
  - Copying from DVD to VCR ..... 17
- ◆ SETTING UP YOUR DVD-VCR
  - Inserting Batteries in the Remote Control ..... 18
  - Setting the Date and Time ..... 18
  - Displaying/Hiding On-Screen Information ..... 19
  - Setting the DVD-VCR Output Channel ..... 19
  - Presetting the Stations Automatically ..... 20
  - Presetting the Stations Manually ..... 21
  - Clearing a Preset Station ..... 22
  - Changing the Preset Station Table ..... 23
- ◆ RECORDING TELEVISION BROADCASTS
  - Selecting the Cassette Type ..... 24
  - Selecting the Recording Speed ..... 24
  - NICAM ..... 25
  - Switching between the TV and VCR Modes ..... 25
  - Protecting a Recorded Cassette ..... 26
  - Recording a Programme Immediately ..... 26
  - Recording a Programme with Automatic Stop ..... 27
  - Using the VIDEOPlus+ Feature ..... 28
  - Modifying VIDEOPlus+ Programming ..... 29
  - Using the Timer Programming Feature ..... 30
  - Checking a Preset Recording ..... 31
  - Cancelling a Preset Recording ..... 31

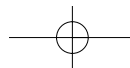

Contents (cont.)



- ◆ PLAYING BACK
  - Playing a Cassette..... 32
  - Adjusting Picture Alignment Automatically ..... 32
  - Adjusting Picture Alignment Manually ..... 32
  - Intelligent Picture Control ..... 33
  - Selecting the Colour Mode ..... 34
  - Selecting the Audio Output Mode..... 35
  - Selecting the Audio Mute Mode..... 35
- ◆ SEARCHING FOR A SEQUENCE
  - Playing a Cassette in Slow Motion ..... 36
  - Playing a Sequence Frame by Frame ..... 37
  - Playing a Sequence at Variable Speeds ..... 37
  - Searching for a Specific Sequence ..... 38
  - Auto Repeat Play..... 39
  - Interval Repeat Play ..... 39
  - Using the Tape Counter ..... 40
- ◆ ADVANCED RECORDING FEATURES
  - Connecting an RCA Audio/Video Input Cable ..... 41
  - Using the Assemble Edit Function..... 42
  - Recording from Another VCR or Camcorder..... 42
  - Audio Dubbing a Pre-recorded Cassette..... 43
- ◆ OTHER FUNCTIONS AND USEFUL RECOMMENDATIONS
  - SQPB (Super VHS Quasi PlayBack)..... 44
  - Auto Power Off ..... 44
- ◆ DVD FUNCTIONS
  - Disc Type and Characteristics ..... 45
  - Choosing a Connection ..... 46
  - Playing a Disc.....47,48
  - Using the Search & Skip Functions ..... 49
  - Using the Display Function (DVD)..... 50
  - Using the Display Function (CD/VCD)..... 50
  - Repeat Play ..... 51
  - Program Play (DVD/VCD/CD) ..... 52
  - Random Playback (DVD/VCD/CD)..... 52
  - Using the Disc View Function (Track View VCD) ..... 53
  - Using the Disc View Function (Index View VCD) ..... 53
  - Selecting the Audio Language (Using the AUDIO button)..... 54
  - Selecting the Subtitle Language (Using the SUBTITLE button) ..... 54
  - Changing the Camera Angle ..... 55
  - Using the Mark Function (DVD/VCD) ..... 56
  - Recalling a Marked Scene..... 56
  - Clearing a Mark ..... 56
  - Using the Zoom (DVD/VCD)..... 57
  - 3D Sound Function..... 57

Contents (cont.)



- ◆ DVD FUNCTIONS
  - Using the Setup Menu..... 58
  - Setting Up the Language Features..... 59
  - Using the Disc Menu Language ..... 59
  - Setting Up the AUDIO Language Features ..... 60
  - Using the Subtitle Language ..... 60
  - Setting Up the Parental Control..... 61
  - Setting Up the Audio Options ..... 62
  - Setting Up the Display Options..... 63
- ◆ Technical Specifications ..... 64
- ◆ SOLVING PROBLEMS
  - Problems and Solutions (VCR)..... 65
  - Troubleshooting Guide (DVD) ..... 66
  - Service Centers List ..... 67

Symbols

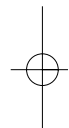
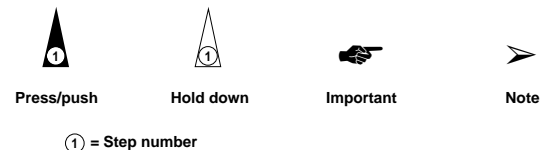

## Safety Instructions

GB

The following illustrations represent precautions.



The lightning bolt is a warning sign alerting you to dangerous voltage inside the product. DO NOT OPEN THE DVD-VCR. Refer to service personnel.

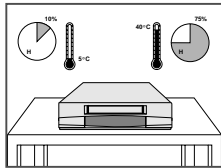

Do NOT expose the DVD-VCR to extreme temperature conditions (below 5°C and above 40°C) or to extreme humidity conditions (less than 10% and more than 75%).

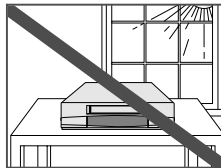

Do NOT expose the DVD-VCR to direct sunlight.

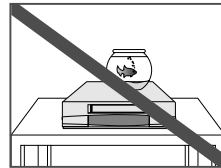

Do NOT expose the DVD-VCR to any liquids.

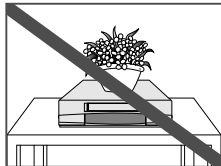

Do NOT place any objects on the DVD-VCR or remote control.

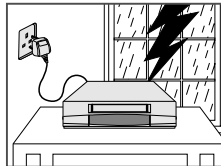

During a storm and/or lightning, unplug the DVD-VCR from the mains socket and aerial.

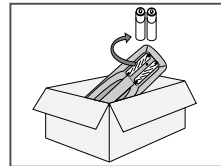

If the remote control is not used for a long period of time, remove the batteries and store it in a cool, dry place.

THIS DEVICE IS NOT FOR USE IN INDUSTRIAL ENVIRONMENTS

## Front View of the DVD-VCR

GB

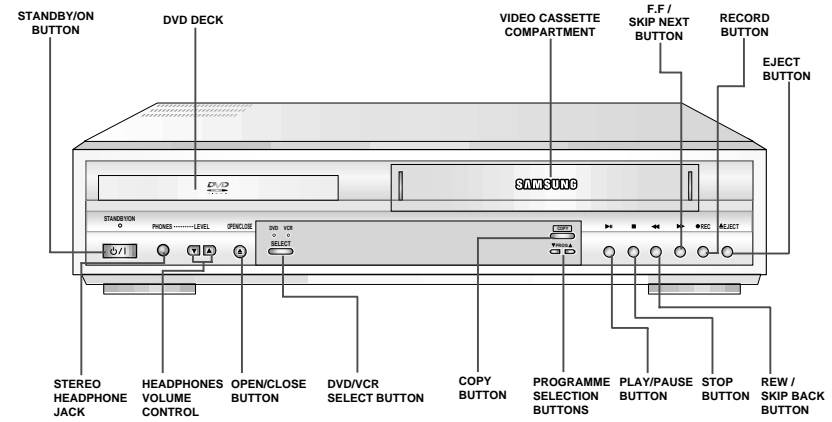

## Rear View of the DVD-VCR

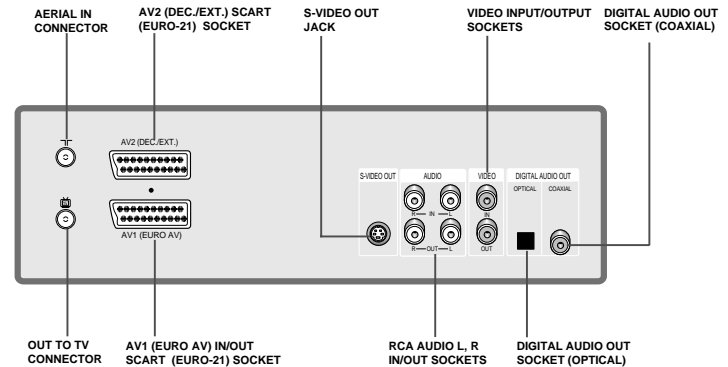

## Infrared Remote Control

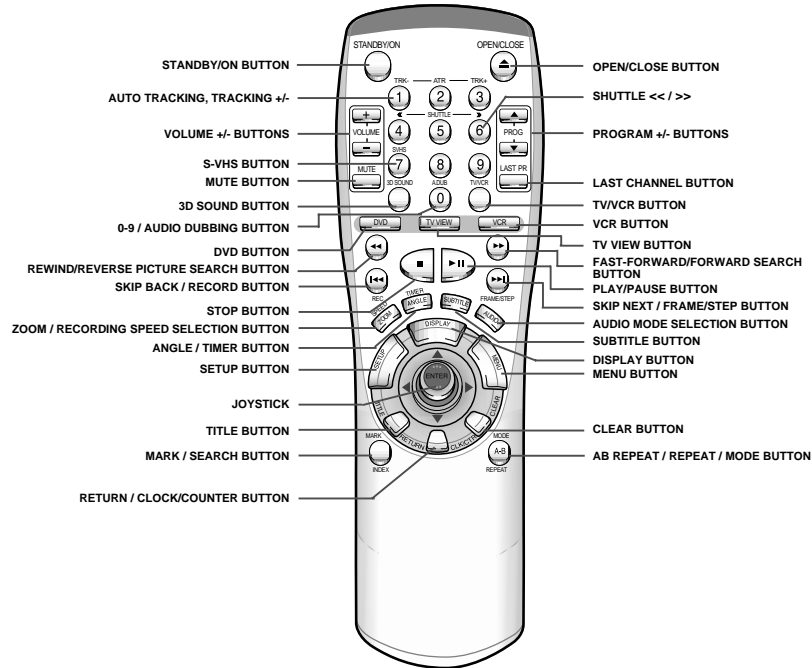

### Function Buttons:

- ◆ **TV VIEW** : Output selection key. Select the output that you want to see.
- ◆ **DVD** : Remote key active for DVD operation.  
If you press DVD button, the **[DVD]** is lighting. It means DVD mode.  
ex) If you press **▶||** (PLAY) key, the DVD will be play.
- ◆ **VCR** : Remote key active for VCR operation.  
If you press VCR button, the **[VCR]** is lighting. It means VCR mode.  
ex) If you press **▶||** (PLAY) key, the VCR tape will be play.
- ◆ **JOYSTICK** : Use for Up (▲), Down (▼), Left (◀), Right (▶), ENTER key.
- ◆ **MENU** : Use for DISC menu of DVD.
- ◆ **SETUP** : Use for SETUP menu of DVD or VCR.

## Display Indicators

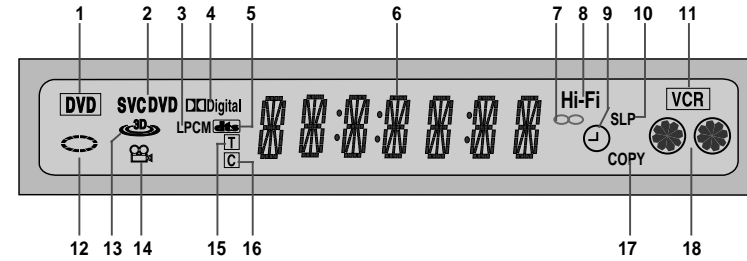

- 1 The DVD Deck is active
- 2 A DVD, CD, VCD or SVCD is loaded
- 3 A disc with LPCM (Linear Pulse Code Modulation) audio is loaded
- 4 A DVD with a Dolby Digital is loaded
- 5 A DVD with a DTS soundtrack is loaded
- 6 The time, counter position, time remaining or current deck status is displayed
- 7 The current TV show or video is broadcast in Stereo
- 8 The Hi-Fi track of a VHS tape is playing
- 9 A Timer Recording is programmed or in progress. If blinking there is an error. Also displays without the clock hands to indicate that a recording is in progress and blinks when the VCR is in Pause mode.
- 10 The VCR Record Speed is set to SP or LP
- 11 The VCR Deck is active
- 12 The status of the DVD deck is graphically displayed
- 13 3D Sound is active
- 14 The DVD has multiple angles to choose from
- 15 The number to the right of the "T" symbol is the current title number
- 16 The number to the right of the "C" symbol is the current title number
- 17 DVD to VHS copy is in progress
- 18 The status of the VCR deck is graphically displayed

## Accessories

*You have just purchased a SAMSUNG Video Cassette Recorder (DVD-VCR). Together with your DVD-VCR, you will find the following accessories in the box.*

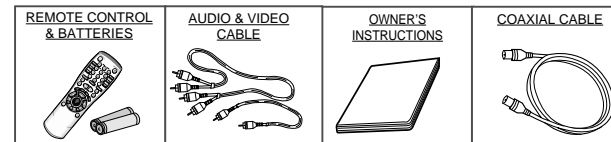





















## Deciding How to Connect DVD-VCR

You must take into account various factors when connecting audio or video systems:

- ◆ Types of connectors available on your systems
- ◆ Systems connected permanently to the DVD-VCR (satellite receiver for example) or temporarily (camcorder for example)

Your DVD-VCR is equipped with the following connectors.

Connector	Location	Type	Direction	Recommended Use
AV1 (EURO AV)	Rear 	SCART	In/Out 	<ul style="list-style-type: none"> <li>◆ Television</li> <li>◆ Satellite receiver</li> <li>◆ Other VCR</li> </ul>
AV2 IN	Rear 	SCART	In 	<ul style="list-style-type: none"> <li>◆ Satellite receiver</li> <li>◆ CANAL/DECODER</li> <li>◆ Other VCR</li> </ul>
Audio input	Rear 	Audio RCA	In 	◆ AUX Audio in
Audio output	Rear 	Audio RCA	Out 	◆ LINE Audio out
VIDEO input	Rear 	RCA	In 	◆ AUX Video in
VIDEO output	Rear 	RCA	Out 	◆ LINE Video out
S-VIDEO output	Rear 	S-JACK	Out 	◆ S-Video out (DVD only)
Digital AUDIO output	Rear 	Optical coaxial	Out 	◆ Digital Audio out (DVD only)
OUT TO TV	Rear 	75 Ω coaxial	Out 	◆ Television
IN FROM ANT.	Rear 	75 Ω coaxial	In 	<ul style="list-style-type: none"> <li>◆ Aerial</li> <li>◆ Cable television network</li> <li>◆ Satellite receiver</li> </ul>

 Whenever you connect an audio or video system to your DVD-VCR, ensure that all elements are switched off.



Refer to the documentation supplied with your equipment for detailed connection instructions and associated safety precautions.

## Connecting DVD-VCR to the TV using the Coaxial Cable

To receive television programmes a signal must be received from one of the following sources:

- ◆ An outdoor aerial
- ◆ An indoor aerial
- ◆ A cable television network
- ◆ A satellite receiver

 Make sure that both the television and the DVD-VCR are switched off before connecting the cables.

- 1 Remove the aerial or network input cable from the television.
- 2 Connect this cable to the 75Ω coaxial socket marked  on the rear of your DVD-VCR.
- 3 Plug the coaxial cable supplied into the  socket on your DVD-VCR.
- 4 Plug the other end of the coaxial cable into the connector previously used for the aerial on the television.
- 5 To obtain better quality pictures and sound on your television, you can also connect your DVD-VCR to the television via the SCART cable (see section below) if your television is equipped with this type of connection.

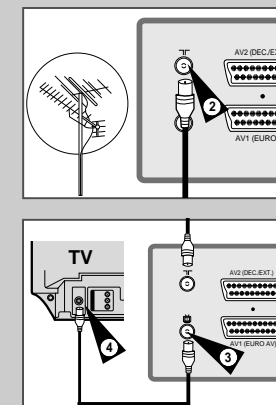

## Connecting DVD-VCR to the TV using the SCART Cable

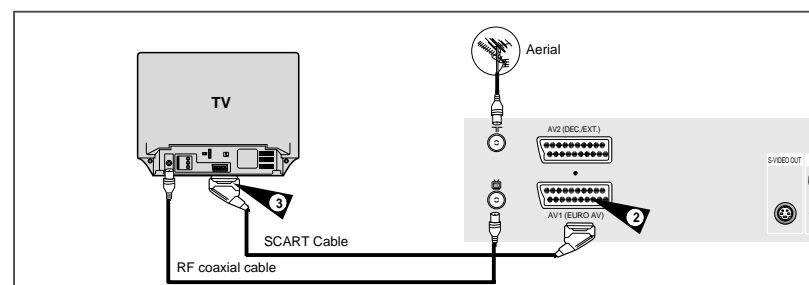

You can connect your DVD-VCR to the television using the SCART cable if the appropriate input is available on the television. You thus:

- ◆ Obtain better quality sound and pictures
- ◆ Simplify the setting up procedure of your DVD-VCR

 Regardless of the type of connection chosen, you must always connect the coaxial cable supplied. Otherwise, no picture will be visible on the screen when the DVD-VCR is switched off.

◆ Make sure that both the television and the DVD-VCR are switched off before connecting the cables.

- 1 Connect the coaxial cable as indicated in the above section.
- 2 Connect one end of the SCART cable to the AV1 (EURO AV) socket on the rear of the DVD-VCR.
- 3 Plug the other end into the appropriate connector on the television.

## Connecting DVD-VCR to a Satellite Receiver or Other Equipment

GB

You can connect your DVD-VCR to a Satellite receiver or other DVD-VCR using the SCART cable if the appropriate outputs are available on the equipment chosen. The following illustrations give a few examples of the connection possibilities.

### 1. AV1(EURO AV): By means of 21-pin Scart Cable

Plug the SCART Cable with satellite receiver or other equipment into the AV1 (EURO AV) socket on the rear of the DVD-VCR.

After making this connection, select the source by pressing the TV VIEW button for the AV1 input sources.

### 2. By means of RF Coaxial Cable

After making this connection, you must preset the station received through the satellite tuner.

RF output channel of the satellite receiver should be adjusted away from channel 60, which is used by the DVD-VCR, e.g. re-adjust to channel 65.

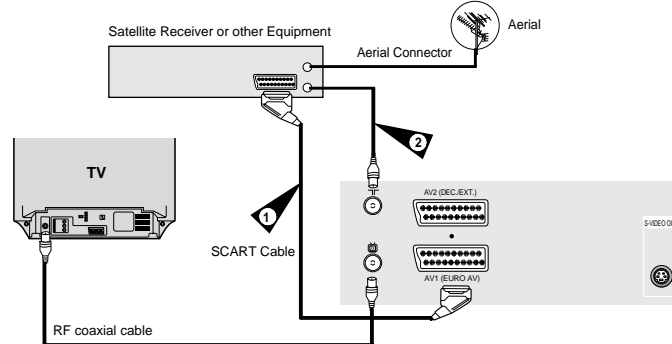

### 1. AV2 IN: By means of 21-pin Scart Cable

Plug the SCART Cable with satellite receiver or other equipment into the AV2 (DEC./EXT.) socket on the rear of the DVD-VCR.

After making this connection, select the source by pressing the TV VIEW button for the AV2 input sources.

### 2. By means of RF Coaxial Cable

After making this connection, you must preset the station received through the satellite tuner.

RF output channel of the satellite receiver should be adjusted away from channel 60, which is used by the DVD-VCR, e.g. re-adjust to channel 65.

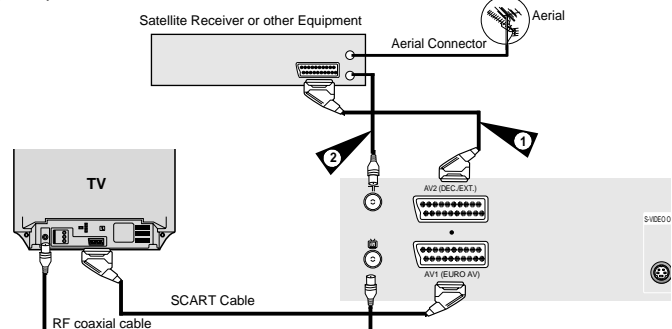

## Connecting the Audio Output Cable

You can connect your DVD-VCR to a Hi-Fi system.

**Example:** You wish to take advantage of the quality of your Hi-Fi stereo system when watching a programme or recording via your DVD-VCR.

- ◆ Regardless of the type of connection chosen, you must always connect the coaxial cable supplied. Otherwise, no picture will be visible on the screen when the DVD-VCR is switched off.
- ◆ Make sure that both the television and the DVD-VCR are switched off before connecting the cables.

- 1 Connect the coaxial cable or SCART as indicated on page 12.
- 2 Plug the audio output cable into the audio connectors on the rear of your DVD-VCR.
  - Respect the colour coding of the left and right channels.
- 3 Plug the other end of the audio cable into the appropriate input connectors on your Hi-Fi stereo system.

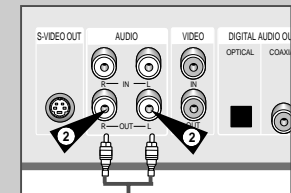
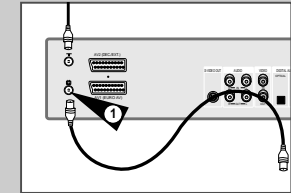

## Plug & Auto Set Up

Your DVD-VCR will automatically set itself up when it is plugged into the mains for the first time. TV stations will be stored in memory. The process takes a few minutes. Your DVD-VCR will then be ready for use.

- 1 Connect the coaxial cable as indicated on page 12. (Connecting Your DVD-VCR to the TV Using the Coaxial Cable)
- 2 Plug the DVD-VCR into the mains. It will automatically tune itself in and store TV stations in the memory.
- 3 The process will finish after a few minutes. Then the DVD-VCR automatically switches itself off.

➤ Now, you only have to switch the DVD-VCR on and it is ready for use.

✎ Function for "Plug & Auto Set Up" is fixed already. So if you want to change this fixed one, you can change it by Presetting the Stations Automatically in OSD " Auto Set Up" menu. (see page 20)

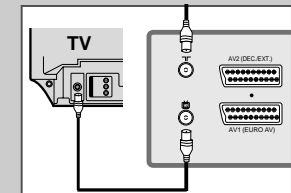

## Tuning Your Television for the DVD-VCR

GB

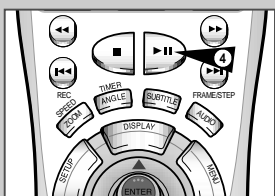
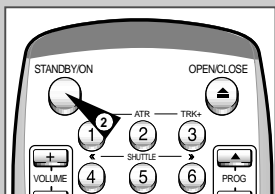

*You must tune your television for the DVD-VCR only if you are not using a Scart cable*

➤ To view pictures from your DVD-VCR when a Scart cable is used, the television must be set to the audio/video mode (AV).

- 1 Switch on the television.
- 2 Switch on the DVD-VCR by pressing STANDBY/ON on the front of the DVD-VCR or STANDBY/ON on the remote control.
- 3 Select a programme position on the television to be reserved for use with your DVD-VCR.
- 4 Insert the video cassette in the DVD-VCR. Check that the DVD-VCR starts reading the cassette; if not, press ►► button.
- 5 Start a scan on your television or set the television to UHF channel 60.
- 6 Fine tune the television until the pictures and sound are obtained clearly.
- 7 If you cannot find the pictures and sound, or there is interference from nearby channels, it may be necessary to change the setting of the DVD-VCR output channel (see Setting the DVD-VCR Output Channel on page 19 and Problems and Solutions on page 65).
- 8 When the picture and sound are perfectly clear, store this channel at the desired programme position on the television.  
**Result:** That programme is now reserved for use with your DVD-VCR.

## Deck Control Keys

*The DVD-VCR uses one set of controls to operate both decks. The following keys are helpful in successfully controlling each deck.*

- 1 **STANDBY/ON Button**  
Press the STANDBY/ON button on the remote control or front panel to turn on the DVD-VCR.
- 2 **DVD Button**  
Press the DVD button on the remote control when you want to control the DVD deck.  
◆ The DVD indicator will light on the Front Panel Display to show that the DVD deck is selected.
- 3 **VCR Button**  
Press the VCR button on remote control when you want to control the VCR deck.  
◆ The VCR indicator will light on the Front Panel Display to show that VHS deck is selected.
- 4 **DVD-VCR Toggle**  
Press the SELECT button on the front panel to toggle control between the DVD deck and the VCR deck.
- 5 **The TV VIEW Key**  
Press the TV VIEW key repeatedly to cycle through all of your input sources, including the DVD, VCR, Tuner (PR#), AV1, AV2 and AUX.

➤ Before using the VCR operation of 14~44 pages, press the VCR button on the remote control to select VCR mode.

Before using the DVD operation of 45~63 pages, press the TV VIEW button on the remote control to select and watch DVD.

GB

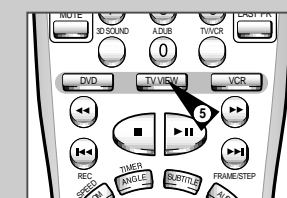
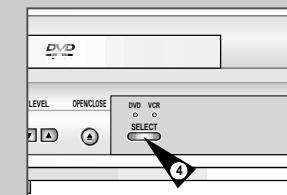
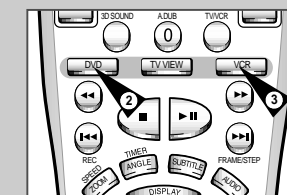
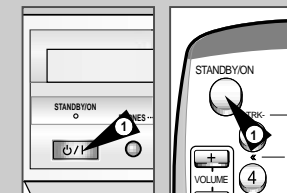



## Basic TV Tuner Operations

The following buttons are used when watching television via the DVD-VCR's built-in TV tuner.



**1 TV/VCR Button**  
Press to switch between your TV's tuner and the VCR's internal tuner.

**2 PROG Up/Down Button**  
Press to change to the next or previous channel.

**3 0-9 Buttons**  
Press to select channels directly.



**4 Last Programme**  
Press to jump directly to the previously viewed channel.

**5 Volume/Mute**  
Press to adjust the volume of the programme you are watching. Press Mute to toggle the sound on and off.  
◆ Also works in DVD and VCR mode.



**6 Display**  
Press to display the channel you are watching.  
◆ Also works in DVD and VCR mode.

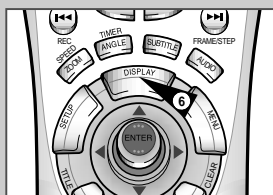

## Copying from DVD to VCR

The DVD-VCR allows you to copy the contents of a DVD to a VHS tape with a press of the COPY button.



If the DVD you are attempting to copy is copy protected, you will not be able to copy the disc. It is not permitted to copy Macrovision® encoded DVDs.

**1 Insert Disc**  
Insert the disc you wish to copy in the DVD deck and close the drawer.

**2 Insert VHS Tape**  
Insert a blank VHS videotape into the VCR deck.

**3 Copy the DVD to VHS Tape**  
Press the COPY button on the DVD-VCR front panel.  
◆ The DVD will go into Play mode and the VCR will go into Record mode.  
◆ If the DVD disc menu appears, you may need to press the PLAY button manually to begin copying.

**4 Stop the Copy Process**  
When the DVD is finished playing, press the VCR button on the remote control and then press the STOP button to end the copy.  
◆ You must stop the Copy process manually when the DVD movie ends or the DVD may replay and record over and over again.



For NTSC DVD or VCD copy

- ◆ Before starting the copy process, set the Quasi PAL to Off in Display options of DVD SETUP MENU. (see page 63)
- ◆ If Quasi PAL is On, the copy process can not activate.
- ◆ The copy is only active PAL tape system.

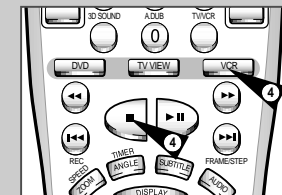
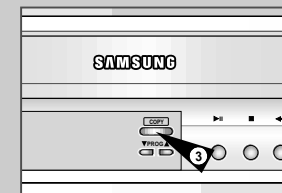
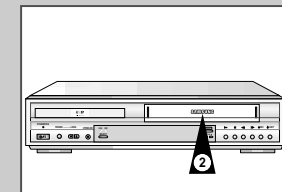
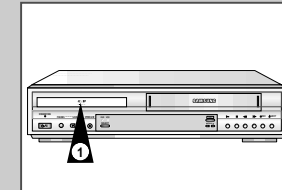

## Inserting Batteries in the Remote Control

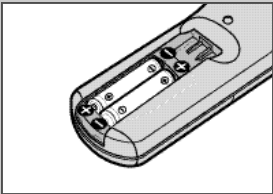
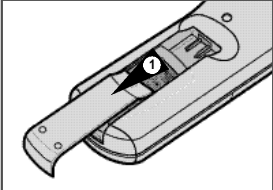

You must insert or replace the batteries in the remote control when you:

- ◆ Purchase the DVD-VCR
- ◆ Find that the remote control is no longer working correctly

- 1 Push the tab in the direction of the arrow to release the battery compartment cover on the rear of the remote control.
- 2 Insert two AA, R6 or equivalent batteries, taking care to respect the polarities:
  - ◆ + on the battery with + on the remote control
  - ◆ - on the battery with - on the remote control
- 3 Replace the cover by aligning it with the base of the remote control and pushing it back into place.

➤ Do not mix different battery types (manganese and alkaline for example).

## Setting the Date and Time

Your DVD-VCR contains a 24-hour clock and calendar used to:

- ◆ Automatically stop programme recording
- ◆ Preset your DVD-VCR to record a programme automatically

You must set the date and time when:

- ◆ You purchase the DVD-VCR
- ◆ The power supply remains off for more than 6 hours

- ☞
- ◆ The time and date are set automatically from the broadcast signal. If the signal is weak or ghosting occurs, the time and date may not be set automatically. In this case, they should be set manually.
  - ◆ Do not forget to reset the time when you change clocks from winter to summer time and vice versa.

- 1 Press SETUP on the remote control.  
**Result:** The programming menu is displayed.
- 2 Press the corresponding ▲, ▼ or ◀, ▶ buttons to select the **CLOCK SET** option.
- 3 Press the ENTER button to select this option.  
**Result:** The **CLOCK SET** menu is displayed.
- 4 Press ◀ or ▶ to select the hour, minutes, day, month and year.  
**Result:** The option selected flashes.
- 5 Press the ▲ or ▼ buttons to increase or decrease the value.  
**Result:** The day of the week is displayed automatically.
  - You can hold the ▲ or ▼ buttons down to scroll more quickly through the values.
- 6 On completion, press SETUP twice to exit the menu.

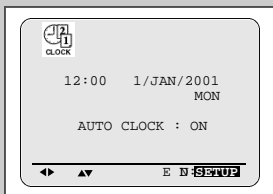
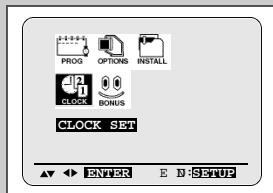

## Displaying/Hiding On-Screen Information

Your DVD-VCR displays most information both on the DVD-VCR and the television.

You can choose to display or hide this information on the television screen (except for the Index, Programming MENU and Timer functions, which cannot be hidden).

- 1 Press SETUP on the remote control.  
**Result:** The programming menu is displayed.
- 2 Press the corresponding ▲, ▼ or ◀, ▶ buttons to select the **USER SET** option.
- 3 Press the ENTER button to select this option.  
**Result:** The **USER SET** menu is displayed.
- 4 Press the corresponding ▲ or ▼ buttons, until the cursor is placed in front of the OSD option.
- 5 

<b>To...</b>	<b>Press ◀ or ▶, until...</b>
Display on-screen information	ON is displayed.
Hide on-screen information	OFF is displayed.
- 6 On completion, press SETUP twice to exit the menu.

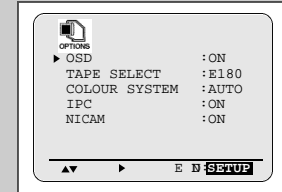
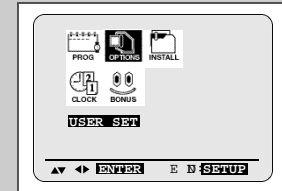

## Setting the DVD-VCR Output Channel

Your DVD-VCR output channel may need to be changed if the pictures suffer from interference or if your TV cannot find the pictures.

Also, you can change the DVD-VCR output channel to adjust the frequency in which information is displayed on the screen.

- 1 Press SETUP on the remote control.  
**Result:** The programming menu is displayed.
- 2 Press the corresponding ▲, ▼ or ◀, ▶ buttons to select the **INSTALLATION** option.
- 3 Press the ENTER button to select this option.  
**Result:** The **INSTALLATION** menu is displayed.
- 4 Press the ▲ or ▼ buttons, until the cursor is placed in front of the **VCR OUTPUT CH** option.
- 5 Select the required output channel (CH21-CH69) by pressing the ◀ or ▶ buttons.
- 6 On completion, press SETUP twice to exit the menu. Then tune your television again (see page 14).

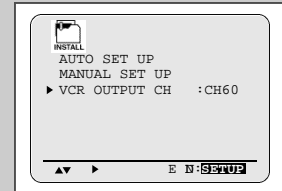
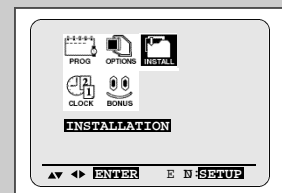

## Presetting the Stations Automatically

GB

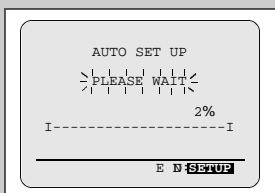
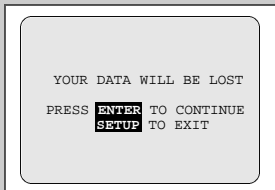
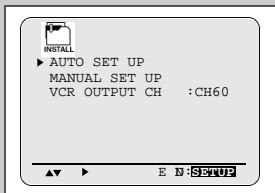
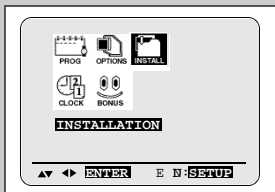
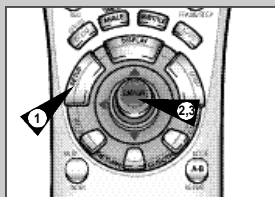

You do not need to preset the stations if you have already set them automatically (see Plug & Auto Set Up on page 13).

*Your DVD-VCR contains a built-in tuner used to receive television broadcasts.*

*You must preset the stations received through the tuner. This can be done:*

- ◆ *Plug & Auto Set up (see page 13)*
- ◆ *Automatically*
- ◆ *Manually (see page 21)*

*You can store up to 99 stations.*

- 1 Press the SETUP button on the remote control.  
Result: The programming menu is displayed.
- 2 Press the corresponding ▲, ▼ or ◀, ▶ buttons to select the **INSTALLATION** option.
- 3 Press the ENTER button to select this option.  
Result: The **INSTALLATION** menu is displayed.
- 4 Press the corresponding ▲ or ▼ buttons, until the cursor is placed in front of the **AUTO SET UP** option. And then press the ▶ button to select this option.  
Result: A message appears, indicating that any channels already preset on your DVD-VCR will be deleted.
- 5 Press ENTER to start the auto scanning.  
Result:
  - ◆ The **P L E A S E W A I T** indication flashes on the television screen.
  - ◆ The first frequency band is scanned and the first station found is displayed and stored.
  - ◆ The DVD-VCR then searches for the second station and so on.
  - ◆ When the automatic scanning procedure has finished, the DVD-VCR switches automatically to programme 1.

➤ The number of stations automatically stored by the DVD-VCR depends on the number of stations that it has found.
- 6 If you wish to cancel the auto scanning before the end, press the SETUP button three times to exit the menu.

- ◆ The time and date are set automatically from the broadcast signal. If the signal is weak or ghosting occurs, the time and date may not be set automatically. In this case, they should be set manually (see page 18).
- ◆ Once the auto scanning procedure has finished, some stations may have been stored more than once; select the stations with the best reception and delete the ones no longer required (see page 22).

## Presetting the Stations Manually

GB

You do not need to preset the stations manually if you have already set them automatically.

- 1 Press the SETUP button on the remote control.  
Result: The programming menu is displayed.
- 2 Press the corresponding ▲, ▼ or ◀, ▶ buttons to select the **INSTALLATION** option.
- 3 Press the ENTER button to select this option.  
Result: The **INSTALLATION** menu is displayed.
- 4 Press the corresponding ▲ or ▼ buttons, until the cursor is placed in front of the **MANUAL SET UP** option.
- 5 Press the ▶ button to select a **MANUAL SET UP** option.  
Result: The **TV STATION TABLE** menu is displayed.
- 6 Press the ▲ or ▼ buttons to select a programme number as required.
- 7 Press the ▶ button to preset the station.  
Result: The **MANUAL SET UP** menu is displayed.
- 8 Press the ◀ or ▶ buttons to start scanning.  
Result: The frequency band is scanned and the first station found is displayed.
- 9 Press the ▲ or ▼ buttons until the cursor is placed in front of the **NAME**.  
Result: The station name is set automatically from the broadcast signal.
- 10 To change the programme's name, press the ▶ button.  
Result: The first letter of the name flashes.
- 11 

<b>To...</b>	<b>Then...</b>
Select a character in the name	Press the ▲ or ▼ button until the required character is displayed (letters, numbers or "-" character).
Move to the next or previous character	Press the ▶ or ◀ buttons respectively.
- 12 

<b>If you...</b>	<b>Then...</b>
Wish to store the station displayed	<ul style="list-style-type: none"> <li>◆ Press the ▲ or ▼ buttons to place the cursor in front of the <b>MFT</b>.</li> <li>◆ Press the ◀ or ▶ buttons to adjust the picture, if necessary.</li> <li>◆ Press OK to store the station</li> </ul>
Do <u>not</u> wish to store the station displayed	<ul style="list-style-type: none"> <li>◆ Press the ▲ or ▼ buttons until the cursor is placed in front of the <b>CH</b>.</li> <li>◆ Press the ◀ or ▶ buttons to go on scanning the frequency band and display the next station</li> <li>◆ Go back to the beginning of Step 12</li> </ul>
- 13 Repeat this procedure from Step 6 onwards, until all the required stations have been stored.
- 14 On completion, press the SETUP button three times to exit the menu.

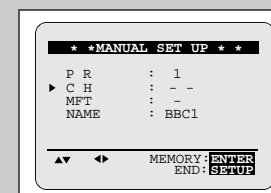
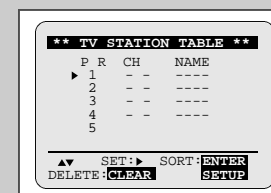
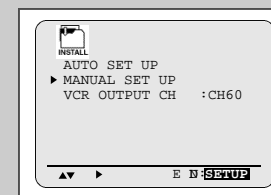
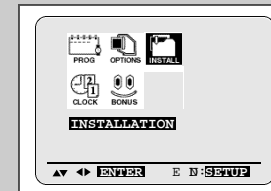

## Clearing a Preset Station

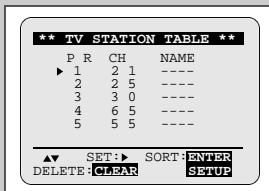
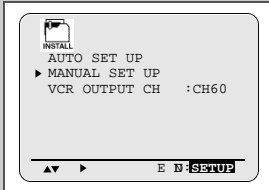
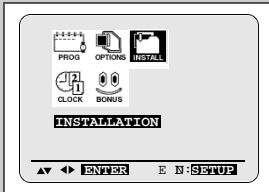

If you have stored a TV station:

- ◆ That you do not require
- ◆ At the wrong programme position

you can cancel it.

- 1 Press the SETUP button on the remote control.
- 2 Press the corresponding ▲, ▼ or ◀, ▶ buttons to select the **INSTALLATION** option.
- 3 Press the ENTER button to select this option.  
**Result:** The **INSTALLATION** menu is displayed.
- 4 Press the corresponding ▲ or ▼ buttons, until the cursor is placed in front of the **MANUAL SET UP** option.
- 5 Press the ▶ button to select this option.  
**Result:** The **TV STATION TABLE** menu is displayed.
- 6 Press the corresponding ▲ or ▼ buttons, until the cursor is placed in front of the required preset TV station. (PR)
- 7 Press the CLEAR button.
- 8 Repeat the same procedure from Step 6 onwards until all the required stations have been cleared.
- 9 On completion, press the SETUP button three times to exit the menu.

## Changing the Preset Station Table

You can rearrange the Station Table and give different programme numbers to the stations listed according to your own preferences.

- 1 Press the SETUP button on the remote control.
- 2 Press the corresponding ▲, ▼ or ◀, ▶ buttons to select the **INSTALLATION** option.
- 3 Press the ENTER button to select this option.  
**Result:** The **INSTALLATION** menu is displayed.
- 4 Press the corresponding ▲ or ▼ buttons, until the cursor is placed in front of the **MANUAL SET UP** option.
- 5 Press the ▶ button to select this option.  
**Result:** The **TV STATION TABLE** menu is displayed.
- 6 Press the corresponding ▲ or ▼ buttons, until the cursor is placed in front of the required preset TV programme.  
**Result:** The selected station is displayed at the same time on the television screen.
- 7 To change the programme number assigned to a station (PR4 instead of PR1 for example):
  - ◆ Press ENTER
  - ◆ Press the ▲ or ▼ buttons until the cursor is placed in front of the programme to which the station is to be moved
  - ◆ Press ENTER again
- 8 You can modify this station by repeating the same procedure from Step 6 onwards.
- 9 On completion, press the SETUP button three times to exit the menu.

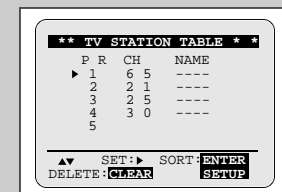
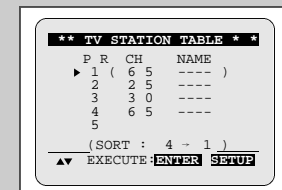
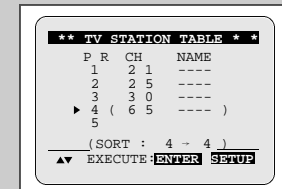
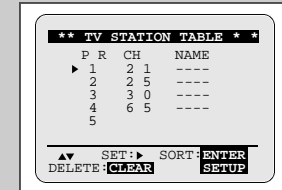

## Selecting the Cassette Type

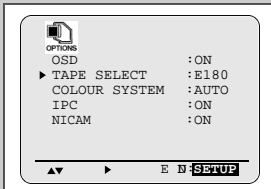
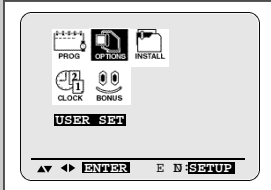

If you wish to use the tape counter to display the time remaining on a cassette, you must indicate the type of cassette inserted.

- 1 Press SETUP on the remote control.  
**Result:** The programming menu is displayed.
- 2 Press the corresponding ▲, ▼ or ◀, ▶ buttons to select the **USER SET** option.
- 3 Press the ENTER button to select this option.
- 4 Press the corresponding ▲ or ▼ buttons, until the cursor is placed in front of the **TAPE SELECT** option.
- 5 Press the ◀ or ▶ buttons as many times as required, until the correct cassette length is displayed.  

→	E180	→	E240
→	E 300	←	E260
- 6 Press SETUP twice to exit the menu.

## Selecting the Recording Speed

Type	Recording Time (in SP)
E-180	180 mins. or 3 hours
E-240	240 mins. or 4 hours
E-260	260 mins. or 4 hours and 20 mins.
E-300	300 mins. or 5 hours

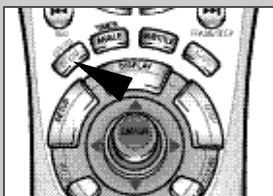

You can record a cassette at two different speeds:

- ◆ **SP (Standard Play)**
- ◆ **LP (Long Play)**

In Long Play modes:

- ◆ Each cassette lasts twice as long
- ◆ The recording is of a slightly lower quality

To record a cassette... Press the **SPEED** button on the remote control, until...

In standard play mode **SP** is displayed.  
In long play mode **LP** is displayed.

## NICAM

NICAM programmes are divided into 3 types. **NICAM Stereo**, **NICAM Mono** and **Bilingual** (transmission in another language). **NICAM** programmes are always accompanied by a standard mono sound broadcast and you can select the desired sound. Please refer to page 35.

- 1 Press SETUP on the remote control.  
**Result:** The programming menu is displayed.
- 2 Press the corresponding ▲, ▼ or ◀, ▶ buttons to select the **USER SET** option.
- 3 Press the ENTER button to select this option.  
**Result:** The **USER SET** menu is displayed.
- 4 Press the corresponding ▲ or ▼ buttons, until the cursor is placed in front of the **NICAM** option.
- 5 **To...** Press ◀ or ▶, until...  

Mono mode	<b>OFF</b> is displayed. OFF: Only set at this position to record the standard mono sound during a NICAM broadcast if the stereo sound is distorted due to inferior reception conditions.
NICAM mode	<b>ON</b> is displayed. ON: Normally set at this position.
- 6 On completion, press SETUP twice to exit the menu.

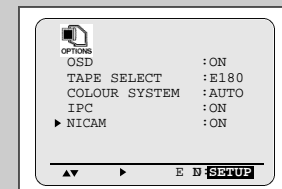
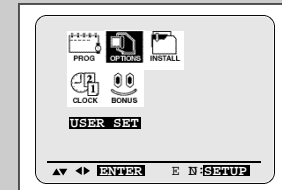

## Switching between the TV and VCR Modes

The **TV/VCR** button allows you to record one channel with the VCR while you watch another channel on the TV.

### Your television...

- On The television receives the picture from the VCR and you can select channels with the PROG (▲ or ▼) buttons on the VCR or the remote control.
- Off (or the VCR is turned off) The television receives the picture from your home aerial or cable television system as it did before you connected the VCR. You can then use the programme (▲ or ▼) buttons on your television to select the channels.



## Protecting a Recorded Cassette

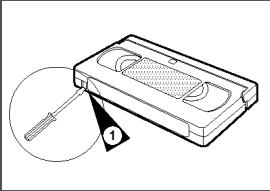

*Video cassettes have a safety tab to prevent accidental erasure. When this tab has been removed, you cannot record on the tape.*

- 1 If you wish to protect a cassette, break off the tab using a small screwdriver.
- 2 To re-record over a protected cassette (safety tab broken), cover the hole with adhesive tape.

## Recording a Programme Immediately

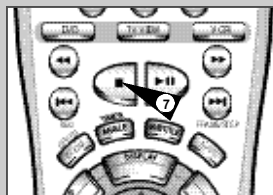
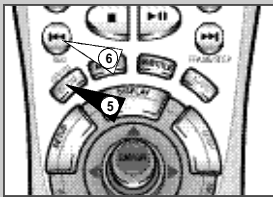
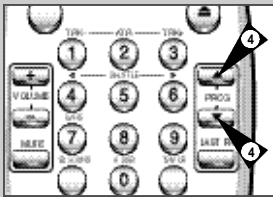

*Before recording a programme, you must have preset the corresponding station (unless you are recording via an external video source). If you have not done so, refer to pages 20 and 21.*

- 1 Switch on the television.
- 2 To monitor the programme being recorded, select the television channel reserved for use with your DVD-VCR (or the AV input if used).
- 3 Insert the cassette on which the programme is to be recorded, with the window visible and the safety tab intact or the opening covered with adhesive tape.  
**Result:** The DVD-VCR is switched on automatically.
- 4 Select:
  - ◆ The station to be recorded using the PROG (▲ or ▼) buttons or
  - ◆ The AV1, AV2 or AUX source using the TV VIEW button for a satellite tuner or external video source**Result:** The station number is displayed and the programme can be seen on the television.
- 5 Select the recording speed by pressing the SPEED button as many times as required (see page 24).
- 6 Hold REC (⏏) down for a while to start recording.  
**Result:** The record indicator appears on the television and DVD-VCR display. An index is recorded on the tape (see page 38).
- 7 To stop recording, press ■ once.

- 
- ◆ If your DVD-VCR ejects the cassette when you start recording, check to make sure that the cassette's safety tab is intact or that the opening (created by a broken safety tab) is covered with adhesive tape.
  - ◆ If you reach the end of the tape while recording, the cassette rewinds automatically.

## Recording a Programme with Automatic Stop

*This function enables you to record up to nine hours (LP) of programmes.*

*Your DVD-VCR stops automatically after the requested length of time.*

- 1 Switch on the television.
- 2 To monitor the programme being recorded, select the television channel reserved for use with your DVD-VCR (or the AV input if used).
- 3 Insert the cassette on which the programme is to be recorded, with the window visible and the safety tab intact or the opening covered with adhesive tape.  
**Result:** The DVD-VCR is switched on automatically.
- 4 Select:
  - ◆ The station to be recorded using the PROG (▲ or ▼) buttons or
  - ◆ The AV1, AV2 or AUX source using the TV VIEW button for a satellite tuner or external video source**Result:** The channel number is displayed and the programme can be seen on the television.
- 5 Select the recording speed by pressing the SPEED button as many times as required (see page 24).
- 6 Hold the REC button (⏏) down for a while to start recording.  
**Result:** The record indicator appears on the television screen and DVD-VCR display. An index is recorded on the tape (see page 38).
- 7 Press the REC button (⏏) several times to increase the recording time in:
  - ◆ 30-minute intervals up to four hours
  - ◆ 1-hour intervals up to nine hours (LP)**Result:** The length is displayed on the television displays. The selected programme is recorded for the length of time requested. At the end of that time, the DVD-VCR stops recording automatically.
- 8 If you wish to cancel the recording before the end, press STANDBY/ON.

- If the end of the tape is reached while recording:
- ◆ The recording stops

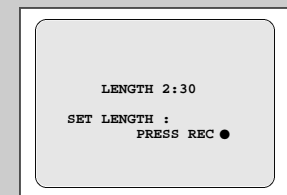
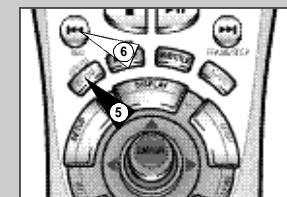
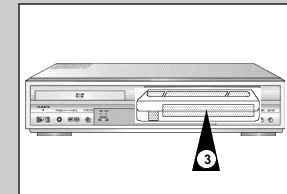

## Using the VIDEOPlus+ Feature

GB

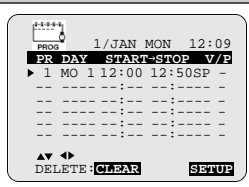
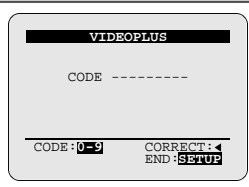
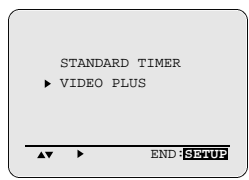
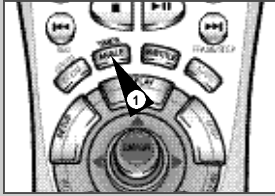

### Before presetting your DVD-VCR:

- ◆ Switch on both the television and your DVD-VCR
- ◆ Check that the date and time are correct
- ◆ Insert the cassette on which the programme is to be recorded (safety tab intact)

### Up to six programmes can be preset.

- 1 To enter a VideoPlus, press the **TIMER** button. Press the **▼** and **▶** buttons to select **VIDEO PLUS**.  
**Result:** A message is displayed to allow you to enter the VIDEOPlus+ code.
  - ☞ If all six programmes have been set, the message **TIMER IS FULL** is displayed. Refer to page 31 if you wish to cancel a preset recording.
- 2 Press the numeric buttons to enter the code opposite the programme that you wish to record in your television magazine.
  - If you wish to correct the VIDEOPlus+ code that you are entering:
    - ◆ Press the **◀** button until the digit to be corrected is cleared
    - ◆ Enter the correct digit
- 3 Press the **SETUP** button.  
**Result:** The information concerning the programme is displayed.
  - ☞ When using the VIDEOPlus+ function for the first time with stored stations, the programme number flashes. This one time, you must enter the station number manually by pressing the **▲** or **▼** buttons. Refer to the following page if:
    - ◆ The programme number or times flash
    - ◆ You wish to modify the programme
- 4 If the programme and times are correct, press the **SETUP** button.
- 5 Press the **STANDBY/ON** button to activate the timer.
- 6 Refer to page 31 if you wish to:
  - ◆ Check that your DVD-VCR has been programmed correctly
  - ◆ Cancel a preset recording

☞ The numbers next to each TV programme listing are VIDEOPlus+ code numbers, which allow you to programme your videorecorder instantly with the remote control. Tap in the VIDEOPlus+ code for the programme you wish to record.

™ VIDEOPLUS+ is a trademark of Gemstar Development Corporation. The VIDEOPLUS+ system is manufactured under licence from Gemstar Development Corporation.

## Modifying VIDEOPlus+ Programming

GB

If you wish to correct the programme displayed or modify certain elements, such as the recording speed, you can do so before you press **SETUP** a second time to confirm.

If you wish to...	Then...
Select an input source other than the tuner (AV1, AV2 or AUX)	<ul style="list-style-type: none"> <li>◆ Press the <b>◀</b> or <b>▶</b> buttons, until the <b>PR</b> selection flashes.</li> <li>◆ Press the <b>▲</b> or <b>▼</b> buttons to change the input source selection. <b>Result:</b> The programme number is replaced by:                             <ul style="list-style-type: none"> <li>• The AV1, AV2 or AUX source using the <b>▲</b> or <b>▼</b> buttons for a satellite tuner or external video source</li> </ul> </li> <li>➤ The input source must be selected before changing any other value.</li> </ul>
Record a programme every day (Monday to Sunday) at the same time	<ul style="list-style-type: none"> <li>◆ Press the <b>◀</b> or <b>▶</b> buttons, until the <b>DAY</b> selection flashes.</li> <li>◆ Press the <b>▲</b> or <b>▼</b> buttons, until the <b>DLY</b> (Daily) value is displayed.</li> </ul>
Record a programme every week on the same day and at the same time	<ul style="list-style-type: none"> <li>◆ Press the <b>◀</b> or <b>▶</b> buttons, until the <b>DAY</b> selection flashes.</li> <li>◆ Press the <b>▲</b> or <b>▼</b> buttons, until the <b>W-</b> (Week) value is displayed, followed by the required day. <b>Example:</b> <b>W-SA</b> (Weekly Saturday)</li> </ul>
Extend the recording time	<ul style="list-style-type: none"> <li>◆ Press the <b>◀</b> or <b>▶</b> buttons, until the <b>STOP</b> selection flashes.</li> <li>◆ Press the <b>▲</b> or <b>▼</b> buttons to increase or decrease the stop time.</li> </ul>
Select the recording speed	<ul style="list-style-type: none"> <li>◆ Press the <b>◀</b> or <b>▶</b> buttons, until the recording speed selection flashes.</li> <li>◆ Press the <b>▲</b> or <b>▼</b> buttons until the correct indication is displayed:                             <ul style="list-style-type: none"> <li>• <b>AUTO</b> (Auto Tape Speed Select) : see page 30</li> <li>• <b>SP</b> (Standard Play)</li> <li>• <b>LP</b> (Long Play)</li> </ul> </li> </ul>
Select the PDC recording	<ul style="list-style-type: none"> <li>◆ Press the <b>◀</b> or <b>▶</b> buttons, until the <b>V/P</b> selection flashes.</li> <li>◆ Press the <b>▲</b> or <b>▼</b> buttons until the "ON" indication is displayed. ☞ Do not select PDC unless you are sure the programme you wish to record is broadcast with PDC. If you do set PDC ON (by selecting "ON" in the right - hand column on the screen), then you must set up the start-time EXACTLY according to the published TV schedule. Otherwise the timer recording won't take place.</li> </ul>

## Using the Timer Programming Feature

GB

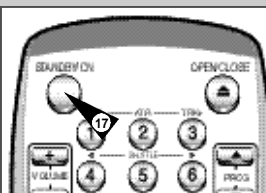
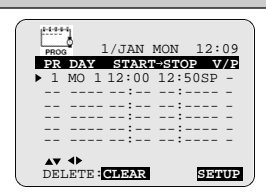

The Timer Programming feature allows you to preset the DVD-VCR to record a programme up to one month before that programme is to be broadcast. Up to six programmes can be preset.

Before presetting a recording, check that the date and time are correct.

- 1 Insert the cassette and press TIMER on the remote control.  
**Result:** The timer selection is displayed.
- 2 Press the ► button to select **STANDARD TIMER** option.  
**Result:** The **TIMER PROGRAMMING** menu is displayed.
- 3 Press ► to select the input source.
- 4 Select the required station by pressing the ▲, ▼ buttons to select the AV1, AV2 or AUX input sources.
- 5 Press ► to select the recording day.
- 6 Select the required day by pressing the ▲ or ▼ buttons.
- 7 Press ► to select the recording start time.
- 8 Select the required hour value by pressing the ▲ or ▼ buttons.
- 9 Press ► to select the minutes.
- 10 Select the required minute value by pressing the ▲ or ▼ buttons.
- 11 Press ► to select the recording stop time.
- 12 Select the required recording stop time by pressing the ▲ or ▼ buttons, following the same procedure as when selecting the recording start time.
- 13 Press ► to select the recording speed.
- 14 Press the ▲ or ▼ buttons to select the **SP** (Standard Play), **LP** (Long Play), **AUTO** (Auto Tape Speed Select) recording speeds.
- 15 Press the ▲ or ▼ buttons to toggle between the VPS or PDC mode (marked **ON**) and the non-VPS/PDC mode (marked **-**).
- 16 When you have finished, press the **SETUP** button.
- 17 Press the **STANDBY/ON** button to activate the timer.  
**Result:** Before starting recording, the DVD-VCR compares the timer duration with the remaining time on the cassette.

➤ Auto Tape Speed Select. The DVD-VCR's "Auto Tape Speed Select" function compares the duration of the timer recording to the actual recording time remaining on the tape loaded. If there is insufficient tape to complete a timer recording in **AUTO** mode, the DVD-VCR automatically switches to **LP** mode to record the whole programme.

## Checking a Preset Recording

GB

You can check your preset recordings:

- ◆ When you have finished presetting the DVD-VCR
- ◆ If you have forgotten which programmes will be recorded

- 1 Press **TIMER** on the remote control.  
**Result:** The timer selection is displayed.
- 2 Press the ► button to select **STANDARD TIMER** option.  
**Result:** The **TIMER PROGRAMMING** menu is displayed.
- 3 Press the ▲ or ▼ buttons to select the required programme.
- 4 Press the ◀ or ▶ buttons to select and change any values as required. For more details, refer to the previous page.
- 5 On completion, press **SETUP** twice.

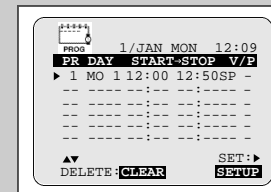

## Cancelling a Preset Recording

You can cancel any programmes that are:

- ◆ **Incorrect**
- ◆ **No longer required**

- 1 Press **TIMER** on the remote control.  
**Result:** The timer selection is displayed.
- 2 Press the ► button to select **STANDARD TIMER** option.  
**Result:** The **TIMER PROGRAMMING** menu is displayed.
- 3 Select the programme to be cancelled by pressing the ▲ or ▼ buttons.
- 4 Press the **CLEAR** button to cancel the selected programme.  
**Result:** All the recording information is deleted and the broadcast will not be recorded.
- 5 On completion, press **SETUP** twice.

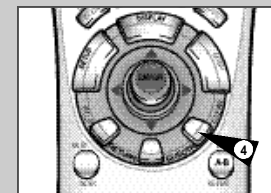
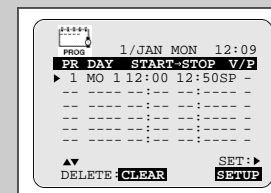



## Playing a Cassette

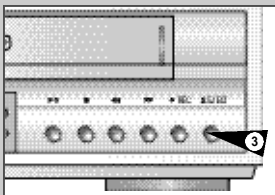
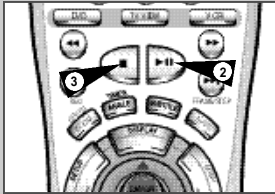

*This function allows you to play back any pre-recorded cassette.*

- 1 Switch on both the television and your DVD-VCR.
- 2 Insert the video cassette to be played. If the safety tab on the cassette is intact, press ►II.  
Otherwise, the cassette is played automatically.  
➤ When a cassette is loaded, the tape position is optimized automatically to reduce disturbance (Digital Auto Tracking). When playing a cassette, if the end of the tape is reached, the cassette is rewound automatically. NTSC tapes can be played back but cannot be recorded with this DVD-VCR.
- 3 

To...	Then press...
Stop the playback	■ (STOP).
Eject the cassette	▲ (EJECT).

## Adjusting Picture Alignment Automatically



*The Picture Alignment feature enables you to optimize the tape position automatically to obtain the best possible picture.*

When noise bars or streaks appear during playback, adjust picture alignment by pressing the ATR button.

- Result:**
- ◆ The tracking bar appears.
  - ◆ The picture is automatically adjusted.
  - ◆ The tracking bar disappears when digital auto tracking has been completed.

## Adjusting Picture Alignment Manually

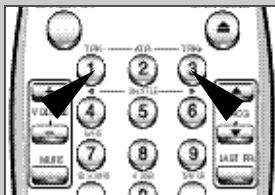

*The Picture Adjustment feature allows you to adjust the alignment manually to obtain the best possible picture.*

When noise bars or streaks appear during playback, adjust alignment manually by pressing the TRK (+ or -) buttons until the picture is clear and stable.

- Result:**
- ◆ The tracking bar appears.
  - ◆ The image is adjusted.
  - ◆ The tracking bar disappears when you release the button.

## Intelligent Picture Control

*The Intelligent Picture Control Feature allows you to adjust the sharpness of the image automatically, according to your own preferences.*

- 1 During playback, press the SETUP button on the remote control.  
**Result:** The programming menu is displayed.
- 2 Press the corresponding ▲, ▼ or ◀, ▶ buttons to select the **USER SET** option.
- 3 Press the ENTER button to select this option.  
**Result:** The **USER SET** menu is displayed.
- 4 Press the corresponding ▲ or ▼ buttons, until the cursor is placed in front of the **IPC** option.
- 5 Press the ▶ button to select the IPC (intelligent picture control) option.  
➤ When intelligent picture control mode is **ON**, the sharpness of the image is adjusted automatically.
- 6 To adjust the sharpness manually, press the ▼ button to turn the IPC mode **OFF**.
- 7 Press the ◀ or ▶ buttons until the picture is displayed according to your preferences.  
➤ If you do not press a button within ten seconds, the **PICTURE** menu disappears automatically.
- 8 On completion, press the SETUP button again.

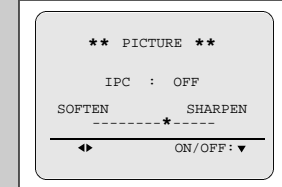
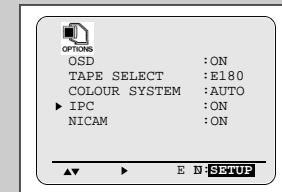
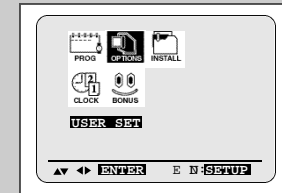

## Selecting the Colour Mode

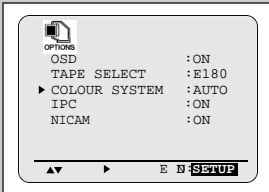
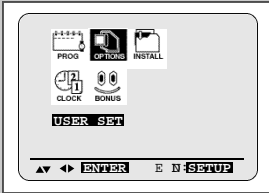

Before recording or playing back a cassette, you can select the required system standard.

Otherwise, the system automatically selects the reception standard when you select AUTO.

- ◆ When playing back a cassette, the standard is automatically selected by the DVD-VCR.
- ◆ When you playback an NTSC-recorded tape on this DVD-VCR make a setting on the colour system according to your TV. If your TV is a PAL system only TV, set NTPB. If your TV is Multi System TV (NTSC 4.43 compatible), set NT4.43 and you can record NT4.43.

- 1 Press SETUP on the remote control.  
**Result:** The programming menu is displayed.
- 2 Press the corresponding ▲, ▼ or ◀, ▶ buttons to select the **USER SET** option.
- 3 Press the ENTER button to select this option.  
**Result:** The **USER SET** menu is displayed.
- 4 Press the corresponding ▲ or ▼ buttons, until the cursor is placed in front of the **COLOUR SYSTEM** option.
- 5 Press the ▶ button to select **AUTO** → **PAL** → **B/W**.
 

<b>AUTO</b>	When playing back a cassette, the system standard is automatically selected by the DVD-VCR.
<b>B/W</b>	Black and White
- 6 On completion, press SETUP twice to exit the menu.

## Selecting the Audio Output Mode

You can select the mode in which the sound is reproduced on the loudspeakers and AV outputs. The following options are available.

Option	Description
L	Used to listen to the sound on the left Hi-Fi channel.
R	Used to listen to the sound on the right Hi-Fi channel.
MIX	Used to listen to the mixed sound of the Hi-Fi and normal channels.
MONO	Used to listen to the sound on the normal mono channel.
L R	Used to listen to Hi-Fi stereo sound on the left and right channels. <ul style="list-style-type: none"> <li>➤ When playing back tapes recorded in Hi-Fi, the sound switches to Hi-Fi after five seconds of Mono.</li> </ul>

To select the sound mode, simply press the AUDIO button on the remote control until the required option is displayed.

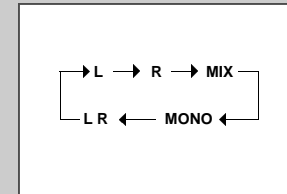
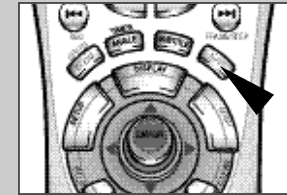

## Selecting the Audio Mute Mode

You can select the Audio Mute mode.

To select the audio mute mode on and off, simply press the MUTE button on the remote control.

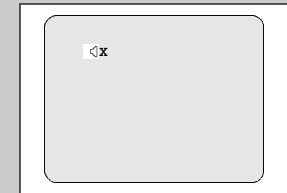
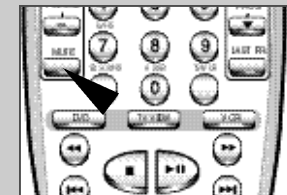

## Playing a Cassette in Slow Motion

GB

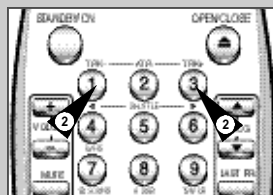
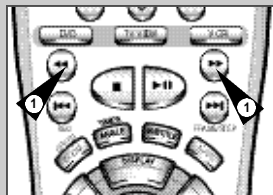

*You can play a cassette in slow motion.*

➤ No sound is heard when playing back a cassette in slow motion.

- 1 Press:
  - ◆ ►|| to start playing the cassette
  - ◆ ►|| button one more time to make STILL mode.
  - ◆ ►► to start SLOW mode.
  - ◆ ►► or ◀◀ button as many times as required to decrease or increase the speed respectively
  - ◆ To return to the normal speed, press the ►|| button twice.
- 2 When playing back in slow motion, picture interference may occur. Press the TRK (+ or -) buttons to minimize this effect.

➤ When you have been using the Slow Motion function for more than about five minutes, the DVD-VCR will automatically play to protect the:

- ◆ Cassette
- ◆ Video heads

## Playing a Sequence Frame by Frame

GB

You can:



- ◆ **Stop the cassette at a given frame (image)**
- ◆ **Advance one frame at a time**

➤ No sound is heard when playing back frame by frame.

- 1 Press:
  - ◆ ►II to start playing the cassette
  - ◆ ►II to still the tape at a given frame
  - ◆ FRAME/STEP (  ) to advance frame by frame

- 2 To return to normal playback, press ►II.

☞ When you have been using the Frame-by-Frame function for more than about five minutes, the DVD-VCR will automatically play to protect the cassette and video heads.

➤ Vertical stability: When playing back frame by frame, interference may be seen on the screen. Press the TRK (  ,  ) buttons to minimize this effect.

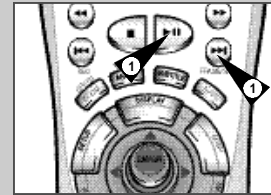

## Playing a Sequence at Variable Speeds

You can vary the playback speed using the Shuttle function (up to nine times the normal speed).

**Example:** You wish to analyze a sportsperson's technique, movement by movement.

The Shuttle function is available on the Remote control

➤ No sound is heard when playing a sequence at variable speeds.

- 1 Press:
  - ◆ ►II during playback
  - ◆ SHUTTLE (<<) to play the cassette backwards
  - ◆ SHUTTLE (>>) to play the cassette forwards

- 2 Each time you press a SHUTTLE button, the speed is changed as shown in the following illustration.

REVERSE PLAY X9	REVERSE PLAY X7	REVERSE PLAY X3	STILL	SLOW MOTION X1/10	SLOW MOTION X1/5	PLAY	PLAY X3	PLAY X7	PLAY X9
-----------------------	-----------------------	-----------------------	-------	-------------------------	------------------------	------	------------	------------	------------

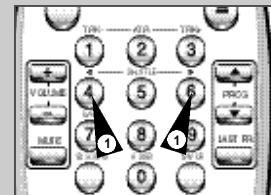

## Searching for a Specific Sequence

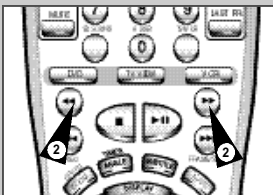
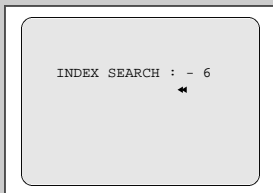
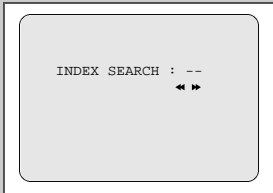
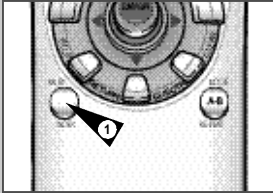

Each time you record a cassette on this DVD-VCR, an "index" is automatically marked on the tape when recording starts. The Search function allows you to fast-forward or rewind to a specific index and start playback from that point. Depending on the direction selected, the indexes are numbered as follows:

etc.	Prev Seq.	Seq. being played	Next Seq.	etc.
	2	1	1	2

➤ This DVD-VCR uses a standard indexing system (VISS). As a result, it will recognize any indexes marked by other VCRs using the same system and vice versa.

- To search for a specific index, press INDEX.
- Press the ◀ or ▶ buttons depending on the direction where your desired programme is located. Each time you press the ◀ or ▶ buttons, the number decreases or increases respectively.  
**Result:** The index number is displayed.
- The DVD-VCR starts to search for the point you specified with the ◀ or ▶ buttons.  
**Result:** When the index is found, cassette playback starts.

➤ You can set an index number up to ±20.

## Auto Repeat Play

You can set repeat play to repeat the tape continuously from beginning to end.

- Press SETUP on the remote control.  
**Result:** The programming menu is displayed.
- Press the corresponding ▲, ▼ or ◀, ▶ buttons to select the **EASY OPERATION** option.
- Press the ENTER button to select this option.  
**Result:** The **EASY OPERATION** menu is displayed.
- Press the corresponding ▲ or ▼ buttons, until the cursor is placed in front of the **REPEAT PLAY** option.
- To...** **Press ◀ or ▶, until...**  
Repeat play **ON** is displayed.  
Do not wish to repeat play **OFF** is displayed.
- On completion, press SETUP twice to exit the menu.

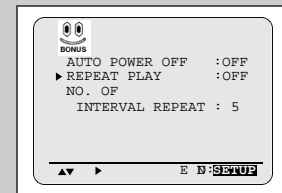

## Interval Repeat Play

You can set Interval Repeat Play so that the cassette is repeated a number of times according to a specified set interval.

- Press SETUP on the remote control.  
**Result:** The programming menu is displayed.
- Press the corresponding ▲, ▼ or ◀, ▶ buttons to select the **EASY OPERATION** option.
- Press the ENTER button to select this option.  
**Result:** The **EASY OPERATION** menu is displayed.
- Press the corresponding ▲ or ▼ buttons, until the cursor is placed in front of the **NO. OF INTERVAL REPEAT** option.
- To...** **Press ▶, until...**  
Interval Repeat Play 5, 10, 15 is displayed.  
(choose an interval repeat of 5, 10 or 15 times)  
Cancel Interval Repeat Play **OFF** is displayed.
- On completion, press SETUP twice to exit the menu.
- To select Interval Repeat Play during playback, press the REPEAT button at the desired start point.  
**Result:** "INTERVAL REPEAT SETTING" is displayed.  
Press the REPEAT button one more time at the desired end point.  
**Result:** The tape is automatically rewound to the start point. "INTERVAL REPEAT" is displayed.

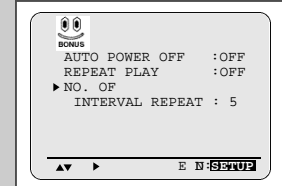
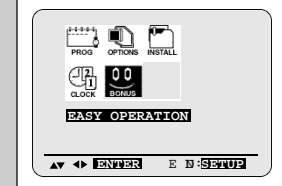
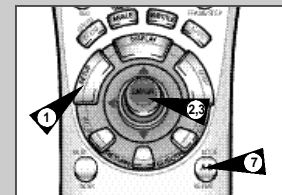

## Using the Tape Counter

GB

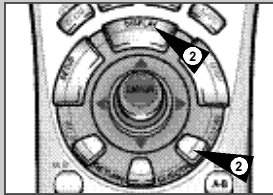
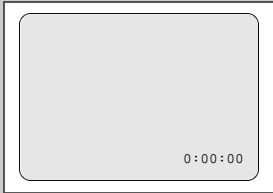

### The tape counter:

- ◆ Indicates the elapsed time in the play and record modes (hours, minutes and seconds)
- ◆ Is reset when a cassette is inserted in the DVD-VCR
- ◆ Allows you to find the beginning of a sequence easily

☞ If the remaining time is to be calculated correctly, you must indicate the type of cassette being used.

- 1 Insert a cassette in your DVD-VCR.
  - 2 To set the tape counter to zero at the beginning of a sequence:
    - ◆ Press DISPLAY twice to display the counter
    - ◆ Press CLEAR when you want to set the tape counter to zero
  - 3 To fast-forward or rewind to the sequence at which the counter was set to zero, simply press ◀ or ▶.
- Result:** The DVD-VCR stops automatically when the counter reaches zero.

➤ Some DVD-VCR information, such as the counter, can be displayed on the television screen (unless you have deactivated the OSD mode; refer to page 19).

### Press DISPLAY:

- ◆ Once to display the current function, programme number, recording speed, date, time and counter
- ◆ Twice to display the counter only
- ◆ Three times to display the time remaining on the cassette
- ◆ Four times to clear the display

## Connecting an RCA Audio/Video Input Cable

GB

You can connect other audio/video equipment to your DVD-VCR using audio/video cables if the appropriate outputs are available on the equipment chosen.

- Examples:**
- ◆ You wish to copy a video cassette with the help of a second VCR (see page 42).
  - ◆ You wish to play back and/or copy pictures taken with a camcorder (see page 42).

☞ Make sure that both the television and the VCR are switched off before connecting the cables.

- 1 Connect one end of the RCA audio/video cable into the VIDEO socket on the Rear of the VCR.
- 2 Plug the other end of the audio/video cable into the appropriate output connector on the other system (VCR or camcorder).
- 3 Connect one end of the RCA audio cable into the AUDIO sockets on the Rear of the VCR.
  - Take care to respect the colour coding of the left and right channels.
- 4 Plug the other end of the audio cable into the appropriate output connectors on the other system (VCR, camcorder or Hi-Fi sound system).

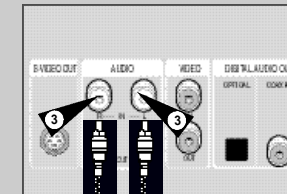
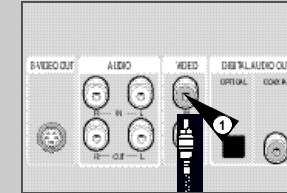

## Using the Assemble Edit Function

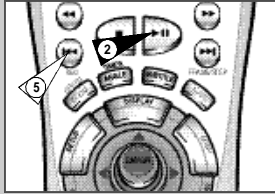

*This function allows you to start a new recording at a specific position on the cassette while maintaining a very smooth scene change.*

- 1 Insert the cassette to be edited in your DVD-VCR.
- 2 Press the ►|| button to start playback.
- 3 When you reach the position from which you wish to start the new recording, press the ►|| button.
- 4 Press the FRAME/STEP (◀▶) button again as often as necessary to advance frame by frame, until the exact recording position is located.
- 5 While the DVD-VCR is in still mode, hold the REC button (⏏) down for a while to activate the Assemble Edit function.  
**Result:** Record symbol flashes in the display.
- 6 Select the source from which you wish to record by pressing:
  - ◆ The PROG(▲ or ▼) buttons for television channels
  - ◆ The TV VIEW button for the AV1, AV2 or AUX input sources
- 7 Press the ►|| button to start recording.
- 8 When you have finished recording, press ■.

## Recording from Another VCR or Camcorder

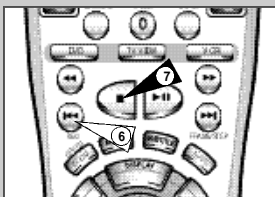
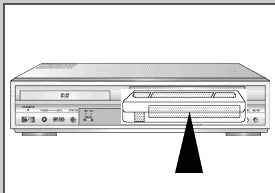

*You can copy a cassette to your SV-DVD1E from another video source, such as another VCR or a camcorder.*

✎ It is an infringement of copyright laws to copy prerecorded cassettes or to re-record them in any form without the permission of the owners of the corresponding copyright.

- 1 Connect the DVD-VCR, from which the cassette is to be copied, to the appropriate SCART audio and video input connectors on the rear of your DVD-VCR, as indicated on page 12.
- 2 Insert a blank cassette in your DVD-VCR.
- 3 Insert the pre-recorded cassette in the other video source (VCR or camcorder).
- 4 Press the TV VIEW button to select the appropriate input on your DVD-VCR:
  - ◆ AV1, AV2 for the SCART input
  - ◆ AUX for the RCA input
- 5 Start playing back the cassette to be copied.
- 6 Hold REC (⏏) down for a while to start recording on your DVD-VCR.
- 7 When you have finished recording, press ■ on both VCR and DVD-VCR.

➤ If you wish to view the cassette being copied:
 

- ◆ Your SV-DVD1E must be connected as usual to the television (see page 11 for further details)

## Audio Dubbing a Pre-recorded Cassette

*With the Audio Dubbing function, you erase the previously recorded sound and replace it with a new soundtrack from:*

- ◆ A CD, DVD
- ◆ A microphone connected to a sound system
- ◆ A cassette player

### **Restriction:**

*Audio dubbing is applicable only to the longitudinal audio track (normal audio).*

- 1 Connect an RCA audio cable to the appropriate output on your sound system (cassette player for example).
- 2 Connect the other end of the RCA audio cable to the audio input connectors (L, R) on the Rear of your DVD-VCR.
- 3 Insert the pre-recorded cassette on which the audio track is to be replaced, and press the ►|| to start playback.
- 4 Search for the Audio Dubbing (ending) point using the ►, and set the counter to 0:00:00 by pressing CLK/CTR and CLEAR.
- 5 Search back slightly beyond the Audio Dub start point using the ◀◀ button.
- 6 Press the ►|| button.  
Press the ►|| button one more time to make STILL mode.
- 7 Press A.DUB.  
**Result:** Your VCR is now in the Audio dubbing Pause mode.
- 8 Press the TV VIEW button to select Audio dubbing source.  
ex) If you want to dub external cassette player, then select AUX.
- 9 On the sound system, locate the point on the cassette at which you wish to start playback.  
**Example:** The track that you wish to record on the cassette.
- 10 When you are ready:
  - ◆ Start playback on the sound system
  - ◆ Press the ►|| on the remote control.**Result:** The soundtrack is replaced on the pre-recorded cassette.
- 11 The audio dubbing will finish when the counter reaches 0:00:00.

➤ The new sound will be recorded on the normal sound track of the tape, and the original sound will remain on the Hi-Fi sound track.  
To hear the new sound and original sound mixed together, press the Audio button on the remote control until the MIX option is displayed (see page 35).

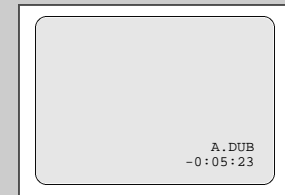
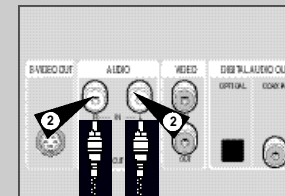
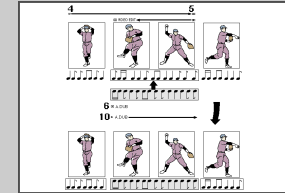

## SQPB (Super VHS Quasi Playback)



*This function is for playback of Super VHS format tapes only, not for recording.*

- 1 Inset the SVHS format tape that you want to see.
- 2 Press PLAY (▶) to start playing the cassette.
- 3 Press SVHS (7) button to start SQPB.

☞ If the SQPB is on during normal playback, the video output is distorted.

## Auto Power Off

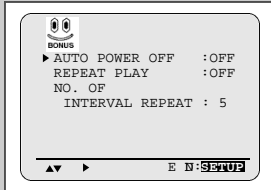
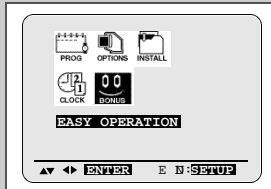

*The Auto Power Off feature automatically turns off your DVD-VCR if no signal is received and you do not press any button for the selected time.*

- 1 Press SETUP on the remote control.  
**Result:** The programming menu is displayed.
- 2 Press the corresponding ▲, ▼ or ◀, ▶ buttons to select the **EASY OPERATION** option.
- 3 Press the ENTER button to select this option.  
**Result:** The **EASY OPERATION** menu is displayed.
- 4 Press the corresponding ▲ or ▼ buttons, until the cursor is placed in front of the **AUTO POWER OFF** option.
- 5 Press the ▶ button, until you select the time of Auto Power off interval.

→ OFF → 2HOUR → 3HOUR

- 6 On completion, press SETUP twice to exit the menu.

## Disc Type and Characteristics

*This DVD player is capable of playing the following types of discs with the corresponding logos :*

Disc Types (Logos)	Recording Types	Disc Size	Max. Playing Time	Characteristics
	Audio + Video	12 Cm	Single-sided 240 min. Double-sided 480 min.	<ul style="list-style-type: none"> <li>DVD contains excellent sound and video due to Dolby Digital and MPEG-2 system.</li> <li>Various screen and audio functions can be easily selected through the on-screen menu.</li> </ul>
		8 Cm	Single-sided 80 min. Double-sided 160 min.	
	Audio + Video	12 Cm	74 min.	<ul style="list-style-type: none"> <li>Video with CD sound, VHS quality &amp; MPEG-1 compression technology.</li> </ul>
		8 Cm	20 min.	
	Audio	12 Cm	74 min.	<ul style="list-style-type: none"> <li>An LP is recorded as an analog signal with more distortion. CD is recorded as a Digital Signal with better audio quality, less distortion and less deterioration of audio quality over time.</li> </ul>
		8 Cm	20 min.	

\* DO NOT play CD-ROM, CD-I, CD-RW and DVD-ROM in this player!  
(CDGs play audio only, not graphics.)

### Disc Markings



• Playback Region Number

PAL

• PAL colour system in U.K, France, Germany, etc.



• Dolby Digital disc

STEREO

• Stereo disc

DIGITAL SOUND

• Digital Audio disc



• DTS disc

### Playback Region Number

Both the DVD player and the discs are coded by region. These regional codes must match in order for the disc to play. If the codes do not match, the disc will not play.

**The Region Number for this player is described on the rear panel of the player.**



## Choosing a Connection

GB

The following show examples of connections commonly used to connect the DVD player with a TV and other components. It is only available for DVD. The DVD-VCR out can not watch by this connection.

### Connection to an Audio System

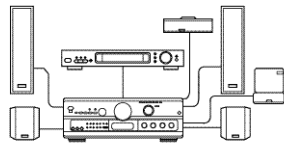

Dolby Digital Decoder  
Digital Audio Input Jack

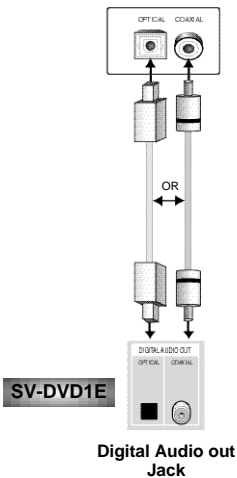

Digital Audio out  
Jack

### Connection of S-Video Jack

TV

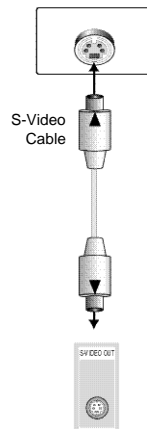

S-Video Jack

## Playing a Disc

GB

### Before Playback :

- ◆ Turn on a TV and press the TV/VIDEO button to select video mode.
- ◆ Turn on your Audio System and select AUX, CD or DVD.
- ◆ Refer to your AUDIO User's Manual.

- 1 Press the OPEN/CLOSE button.  
The STANDBY indicator light goes out and the tray opens.
- 2 Place a disc gently into the tray with the disc's label facing up.
- 3 Press the ►|| (PLAY/PAUSE) button or OPEN/CLOSE button to close the disc tray.

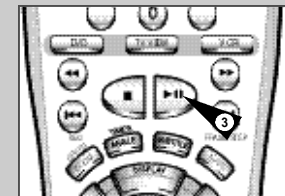
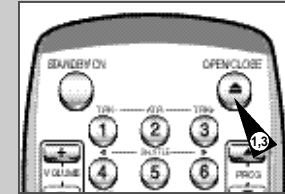

### RESUME function :

When you stop disc play, the player remembers where you stopped, so when you press PLAY again, it will pick up where you left off (unless the disc is removed, the STOP button is pressed twice or the player is unplugged.).



- ◆ If the player is left for 5 minutes in pause mode, it will stop.
- ◆ This ⓪ icon indicates an invalid button press.



Before using the DVD operation, press the TV VIEW button on the remote control to watch and select DVD.

## Playing a Disc

GB

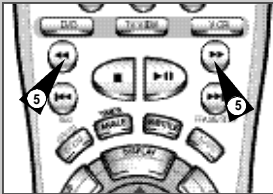
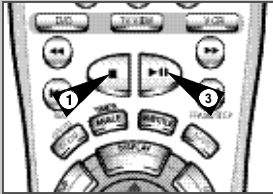

- 1 Stopping Playback. Press the STOP button during playback.
- 2 Removing Disc. Press the OPEN/CLOSE button.
- 3 Pausing Playback.  
Press the ►|| (PLAY/PAUSE) button on the remote during playback.
  - ◆ Screen stops, no sound.
  - ◆ To resume again, press ►|| (PLAY/PAUSE) button once again.
- 4 Step Motion Playback (Except CD)  
Press the STEP button on the remote during pausing playback.
  - ◆ Each time the button is pressed, a new frame will appear.
  - ◆ No sound is heard during STEP mode.
  - ◆ Press ►|| (PLAY/PAUSE) to resume normal playback.  
(You can only perform step motion playback in the forward direction.)
- 5 Slow Motion Playback (Except CD)  
Press the ► button on the remote during PAUSE or STEP mode.
  - ◆ By pressing the ►, ◀ button, you can select slow motion playback for 1/2, 1/4 or 1/8 of normal speed.
  - ◆ No sound is heard during slow mode.
  - ◆ Press ►|| (PLAY/PAUSE) to resume normal playback.
  - ◆ When playing, the reverse slow motion playback will not work.

## Using the Search & Skip Functions

GB

*During playback, you can search quickly through a chapter or track or use the skip function to jump to the next selection.*

- 1 During playback, press the ► or ◀ button on the remote.
  - ◆ Press the ► or ◀ button on the remote and press again to search at a faster speed(2X/4X/8X/16X/32X/128X normal speed, in order) on the DVD.
  - ◆ Press the ► or ◀ button on the remote and press again to search at a faster speed(4X/8X/normal speed in order) on VCD and CD.
  - ◆ To return to normal speed playback, press the ►|| (PLAY/PAUSE) button.
- 2 During playback, press the ►|| (NEXT SKIP) or ◀◀ (BACK SKIP) button.
  - ◆ When playing a DVD, if you press the ►|| (NEXT SKIP) button, it moves to next chapter. If you press the ◀◀ (BACK SKIP) button, it moves to the beginning of the chapter. One more press makes it move to the beginning of the previous chapter.
  - ◆ When playing a VCD 2.0 in MENU OFF mode, a VCD 1.1 or a CD, if you press the ►|| (NEXT SKIP) button, it moves to next track. If you press the ◀◀ (BACK SKIP) button, it moves to the beginning of the track. One more press makes it move to the beginning of the previous track.
  - ◆ If a track exceeds 15 minutes when playing a VCD and you press the ►|| (NEXT SKIP) button, it moves forward 5 minutes. If you press the BACK SKIP button, it moves backward 5 minutes.
  - ◆ When playing a VCD 2.0 in the MENU MODE or Track View function, if you press the ►|| (NEXT SKIP) button, it moves to the next MENU or the next Track View display. If you press the ◀◀ (BACK SKIP) button, it moves to the previous MENU or the previous Track View display. (See page 53.)



- ◆ When in search mode (8X/16X/32X/128X) on a DVD or high-speed playback on a VCD, no sound will be heard.
- ◆ When 2X SCAN AUDIO is set to ON in the SETUP MENU, no sound will be heard on discs which are recorded with LPCM, DTS or MPEG-2.
- ◆ Depending on the disc, audio may not be heard when a disc is in 2X playback mode.

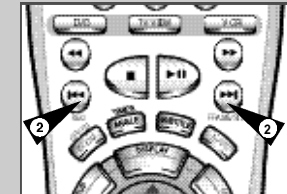
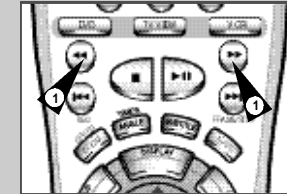

## Using the Display Function (DVD)

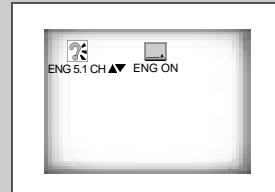

- 1 During playback, press the DISPLAY button on the remote.
  - Current title, chapter number and elapsed time will be displayed.
  - ◆ Use the ◀, ▶ button to select a title or a chapter number.
    - Use the ▲, ▼ button or Number buttons to enter a different title or chapter number, then press the ENTER button.
  - ◆ To enter the time from which you want to start, use the ◀, ▶ button to select, then use the Number buttons to enter the time. Then press the ENTER button.
- 2 Press the DISPLAY button on the remote twice.
  - Current audio, subtitle and volume control will appear.
  - To make the screen disappear, press the DISPLAY button again.

## Using the Display Function (CD/VCD)



- 1 During playback, press the DISPLAY button on the remote.
  - Current track number, elapsed time and volume control will be displayed.
  - ◆ Use the ◀, ▶ button to select a track. Use the ▲, ▼ button or Number buttons to enter a different track number, then press the ENTER button.
  - ◆ To enter the time from which you want to start, use the ◀, ▶ button to select, then use the Number buttons to enter the time. Press the ENTER button.
  - To make the screen disappear, press the DISPLAY button again.



### What is a Chapter?

Each Title on a DVD can be divided into chapters (similar to tracks on an audio CD).

### What is a Title?

A DVD may contain several different titles. For example, if a disc contains four different movies, each might be considered a title.

## Repeat Play

*Repeat the current track, chapter, title, a chosen section (A-B), or all of the disc (VCD/CD only).*

*When Playing a DVD :*

- 1 Press the REPEAT button on the remote. Repeat screen appears.
- 2 Select Chapter, Title or A-B using the ◀, ▶ button.
  - A-B Repeat
    - ◆ Press the REPEAT button. Select A-B on screen with the ◀, ▶ button. Or press the A-B button on the remote.
    - ◆ Press ENTER at the point where you want the repeat play to start (A). The B is automatically highlighted.
    - ◆ Press ENTER at the point where you want the repeat play to stop (B).
    - ◆ The A-B Repeat that you set plays until you turn Repeat off.
- 3 Press ENTER.
- 4 To return to normal playback press REPEAT again, then press the ◀, ▶ button to select Off and press ENTER.

- 
- ◆ DVD repeats playback by chapter or title, CD and VCD repeat playback by disc or track.
  - ◆ Depending on the disc, the Repeat function may not work.
  - ◆ If the title or track is completed before marking the end (B), the end of title or track becomes B automatically.
  - ◆ When in VCD 2.0 mode (MENU ON mode), this function does not work.

GB

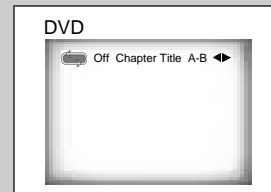
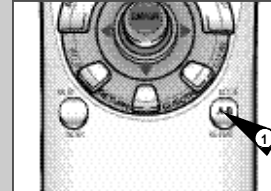

## Program Play (DVD/VCD/CD)

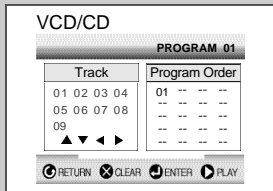
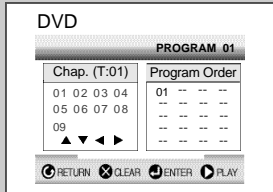

- 1 Press the MODE button.
- 2 Use the ◀, ▶ button to select PROGRAM. Press the ENTER button.
- 3 Use the ◀, ▶ button to select the first chapter (or track) to add to the program. Press the ENTER button. The selection numbers appear in the Program Order box.
- 4 Press the ▶|| (PLAY/PAUSE) button. The disc will be played back in programmed order.

➤ ◆ To resume normal playback, press the CLEAR button.

## Random Playback (DVD/VCD/CD)

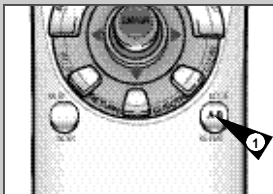

- 1 Press the MODE button.
- 2 Use the ◀, ▶ button to select RANDOM. Press the ENTER button. The disc will be played back in random order.

➤ ◆ Depending on the disc, the Program and Random Playback function may not work.  
 ◆ When in VCD 2.0 mode (MENU ON mode), these functions do not work.  
 ◆ To resume normal playback, press the CLEAR button.

## Using the Disc View Function (Track View VCD)

*Displays the beginning view of each track and the track number.*

- 1 During playback, press the TITLE button.
- 2 Press the ▲, ▼ button to select Track View. Press the ENTER button.
- 3 Select the desired view by pressing the ▲, ▼ or ◀, ▶ buttons.
- 4 Press the ENTER button.

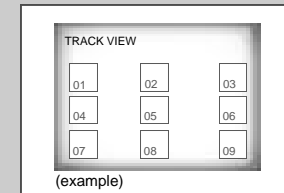
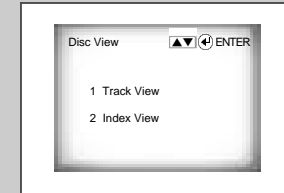

## Using the Disc View Function (Index View VCD)

*Displays the equally divided 9 views of the current playing track.*

- 1 During playback, press the TITLE button.
- 2 Press the ▲, ▼ button to select Index View. Press the ENTER button.
- 3 Select the desired view by pressing the ▲, ▼ or ◀, ▶ buttons.
- 4 Press the ENTER button.

➤ ◆ In stop mode on VCD, press the TITLE button and the TRACK VIEW will be displayed.  
 ◆ **When pressing the TITLE button with a DVD;** the disc's TITLE MENU function comes up. A disc must have at least two titles for the TITLE MENU function to work.  
 ◆ **When pressing the TITLE button with a CD;** the unit enters the INTRO mode. INTRO lets you listen to the beginning of each track for about 10 seconds.

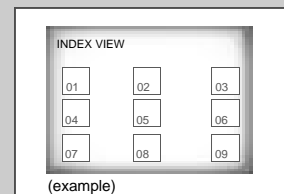

## Selecting the Audio Language (Using the AUDIO button)

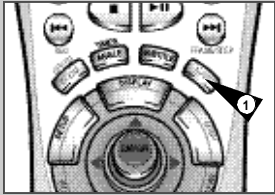

You can select a desired language quickly and easily with the **AUDIO** button.

- 1 Press the **AUDIO** button.
- 2 Use the **▲**, **▼** button to select the desired language on a DVD.  
- The audio and subtitle languages are represented by abbreviations.
- 3 Use the **▲**, **▼** button to select **STEREO**, **R CHANNEL** or **L CHANNEL**. (On VCD/CD)

## Selecting the Subtitle Language (Using the SUBTITLE button)

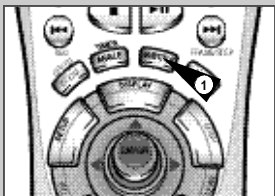

You can select a desired subtitle quickly and easily with the **SUBTITLE** button.

- 1 Press the **SUBTITLE** button.
- 2 Use the **▲**, **▼** button to select the desired subtitle language.
- 3 Use the **◀**, **▶** button to determine whether or not the subtitle will be displayed.  
- Initially, the subtitling will not appear on screen.  
- The audio and subtitle languages are represented by abbreviations.

- ♦ This function depends on what languages are encoded on the disc and may not work with all DVDs.
- ♦ A DVD disc can contain up to 32 subtitle languages.

## Changing the Camera Angle

When a DVD contains multiple angles of a particular scene, you can select the **Angle** function.

Using the **ANGLE** button :

Check to see if an '**ANGLE** (  )' mark is present at the upper right hand corner of the screen.

- 1 When an '**ANGLE**' mark is shown, press the **ANGLE** button.
- 2 Use the **▲**, **▼** button to select the desired screen angle. Then press the **ENTER** button.
- 3 To turn off the display, press the **ANGLE** button again.

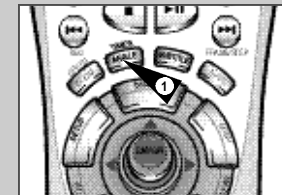
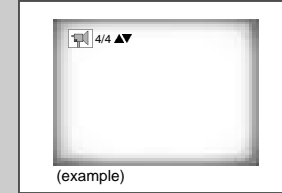

## Using the Mark Function (DVD/VCD)

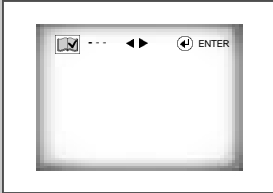

*The Mark function lets you select parts of a DVD or VCD (MENU OFF mode) so that you can quickly find the section at a later time.*

- 1 During playback, press the MARK button on the remote. A marker will be displayed.
- 2 Use the ◀, ▶ button to move to the desired bookmark icon.
- 3 When you reach the scene you want to mark, press the ENTER button. The icon will change to a number (1, 2, or 3).
- 4 Press the MARK button to turn off the display.

## Recalling a Marked Scene



- 1 During playback, press the MARK button on the remote.
- 2 Use the ◀, ▶ button to select a marked scene.
- 3 Press the ►► (PLAY/PAUSE) button to skip to the marked scene.

## Clearing a Mark

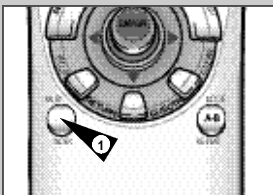

- 1 During playback, press the MARK button on the remote.
- 2 Use the ◀, ▶ button to select the bookmark number you want to delete.
- 3 Press the CLEAR button to delete a bookmark number. Press the MARK button to turn off display.

- ♦ Up to three scenes may be marked at the same time.
- ♦ When in VCD 2.0 mode (MENU ON mode), this function does not work.
- ♦ Depending on the disc, the Bookmark function may not work.

## Using the Zoom (DVD/VCD)

- 1 During playback or pause mode, press the ZOOM button on the remote. A square will be displayed on screen.
- 2 Use the ▲, ▼ or ◀, ▶ button to select the part of the screen you want to zoom.
- 3 Press the ENTER button.
  - During DVD playback, press ENTER to zoom in 2X/4X/normal in order.
  - During VCD playback, press ENTER to zoom in 2X/normal in order.

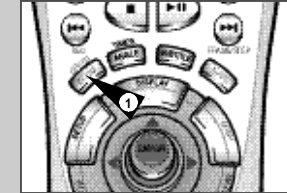

## 3D Sound Function

*The simulated surround effect (SPATIALIZER N-2-2) depends on the disc contents. If you connect the unit to your stereo system, you can enhance sound quality and produce a greater surround effect.*

*This feature is useful when you are using the DVD player with a two channel stereo through the analog outputs. (Discs which are recorded with LPCM or DTS will not work. When the DOLBY DIGITAL OUT or MPEG-2 DIGITAL OUT are set to BITSTREAM in the SETUP MENU, the 3D Sound function will not work.)*

- 1 During playback, press the 3D SOUND ( ) button. The 3D SOUND mark will be displayed on screen. (Be sure the DOLBY DIGITAL OUT or MPEG-2 DIGITAL OUT are set to PCM.)
- 2 Press the ▲, ▼ button to turn the 3D Sound feature on or off.

- ♦ 3D Sound is possible only on discs recorded using DOLBY SURROUND or DOLBY DIGITAL. However, some of these discs do not contain rear channel sound signals.
- ♦ Depending on the disc, the Zoom and 3D Sound function may not work.

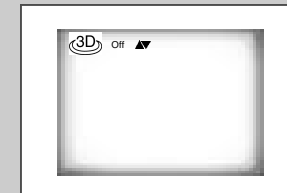

## Using the Setup Menu

GB



*The Setup menu lets you customize your DVD player by allowing you to select various language preferences, set up a parental level, even adjust the player to the type of television screen you have.*

- 1 With no disc playing, press the SETUP button on the remote.

Player Menu ①	Setup of the Display. Language (See page 59) Use the Player preference menu to select the language for the player's on-screen displays.
Disc Menu ②	Setup of the Menu Language (See page 59) Use the Menu preference menu to select the language you want a DVD's disc menu to be displayed in.
Audio ③	Setup of the Audio Language (See page 60) Use the Audio preference menu to select the soundtrack language.
Subtitle ④	Setup of the Subtitle Language (See page 60) Use the Subtitle preference menu to select the language the disc's subtitles are to be displayed in.
Parental ⑤	Setup of the Parental Level (See page 61) Allows users to set the level necessary to prevent children from viewing unsuitable movies such as those with violence, adult subject matter, etc.
Audio Options ⑥	Setup of the Audio Options (See page 61)
Display Options ⑦	Setup of the Display Options (See page 62) Use to select which type of screen you want to watch and several display options.

- 2 Use the ▲, ▼ button on the remote to access the different features.
- 3 Press the ENTER button to access the sub features. To make the setup screen disappear after setting up, press the SETUP button again.

➤ Depending on the disc, some Setup Menu selections may not work.

## Setting Up the Language Features

GB

*If you set the player menu, disc menu, audio and subtitle language in advance, it will come up automatically every time you watch a movie.*

**Using the Player Menu :**

- 1 With no disc playing, press the SETUP button.
- 2 Use the ▲, ▼ button to select the Player Menu.
- 3 Press the ENTER button.
- 4 Use the ▲, ▼ button to select 'English'.
- 5 Press the ENTER button.
  - English is selected and the screen returns to SETUP MENU.
  - To make the SETUP MENU disappear, press the RETURN button.

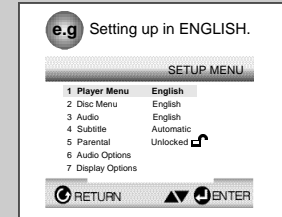

## Using the Disc Menu Language

*This function changes the language only for the text on the disc menu screens.*

- 1 With no disc playing, press the SETUP button.
- 2 Use the ▲, ▼ button to select Disc Menu.
- 3 Press the ENTER button.
- 4 Use the ▲, ▼ button to select 'English'.
  - Select "Others" if the language you want is not listed.
- 5 Press the ENTER button.
  - English is selected and the screen returns to SETUP MENU.

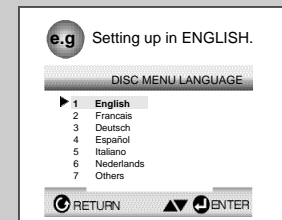



## Setting Up the AUDIO Language Features



### Using the Audio Language :

- 1 With no disc playing, press the SETUP button.
- 2 Press the ▲, ▼ button to move to Audio.
- 3 Press the ENTER button.
- 4 Press the ▲, ▼ button to select 'English'.
  - Select "Original" if you want the default soundtrack language to be the original language the disc is recorded in.
  - Select "Others" if the language you want is not listed.
- 5 Press the ENTER button.
  - English is selected and the screen returns to SETUP MENU.

## Using the Subtitle Language

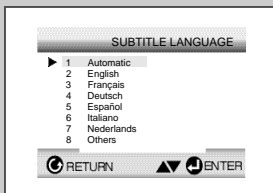

- 1 With no disc playing, press the SETUP button.
- 2 Use the ▲, ▼ button to select Subtitle.
- 3 Press the ENTER button.
- 4 Use the ▲, ▼ button to select 'English'.
  - Select "Automatic" if you want the subtitle language to be the same as the language selected as the audio preference.
  - Select "Others" if the language you want is not listed. Some discs may not contain the language you select as your initial language; in that case the disc will use its original language setting.
- 5 Press the ENTER button.
  - English is selected and the screen returns to SETUP MENU.

- 
- ◆ If the selected language is not recorded on the disc, the original pre-recorded language is selected.
  - ◆ **How to make the SETUP MENU disappear or return to menu screen during set up:** Press RETURN button.

## Setting Up the Parental Control

*The Parental Control function works in conjunction with DVDs that have been assigned a rating - which helps you control the types of DVDs that your family watches. There are up to 8 rating levels on a disc.*

- 1 With no disc playing, press SETUP. The Setup Menu screen appears.
- 2 Use ▲, ▼ to select Parental. Press ENTER. The Parental Control screen appears.
- 3 Use ◀, ▶ to select Yes if you want to use a password. Press ENTER. The Enter Password screen appears.
- 4 Enter your password. The Re-enter Password screen appears to confirm the password. Enter your password again. The Parental Control screen appears.
- 5 About the Rating Level ;  
The Rating Level will work only when Use Password is set to Yes. To unlock the player, use ◀, ▶ to select No. Use ▲, ▼ to select Rating level. Press ENTER.
  - Use ▲, ▼ to select the level (e.g. Level 6) and press ENTER. The disc that contains Level 7 will now not play.
  - To cancel the rating level, use ◀, ▶ to select No in Use Password.
- 6 About the Change Password ;
  - Use ▲, ▼ to select Change Password. The Change Password screen appears.
  - Enter your new password. Re-enter the new password again.

- 
- ◆ **How to make the SETUP MENU disappear or return to menu screen during set up:** Press RETURN button.
  - ◆ If you have forgotten your password, see Forget Password in the Troubleshooting Guide.

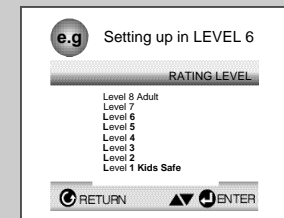
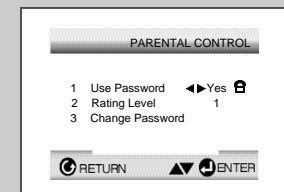
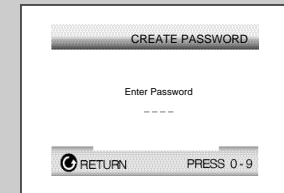
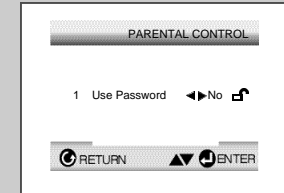

## Setting Up the Audio Options

GB

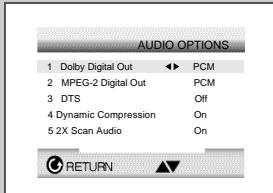

- 1 With no disc playing, press the SETUP button.
- 2 Use the ▲, ▼ button to select Audio Options. Then press the ENTER button.
- 3 Use the ▲, ▼ button to select the desired item. Then press the ◀, ▶ button.

- 1 Dolby Digital Out / 2 MPEG-2 Digital Out
  - 1 PCM : Converts to PCM(2CH) 48kHz/16Bit audio. Select PCM when using the Analog Audio Outputs.
  - 2 Bitstream : Converts to Dolby Digital BITSTREAM - 5.1CH (in case of MPEG-2, 7.1CH). Select BITSTREAM when using the Digital Audio Output.

NOTE : Be sure to select the correct Digital Output or no audio will be heard.

- 3 DTS
  - 1 Off : Doesn't output digital signal.
  - 2 On : Outputs DTS BITSTREAM via digital output only. Select DTS when connecting to a DTS DECODER.
- 4 Dynamic Compression
  - 1 On : To select dynamic compression.
  - 2 Off : To select the standard range.
- 5 2X Scan Audio
  - 1 On : Turns 2X audio on.
  - 2 Off : Turns 2X audio off. Though 2X SCAN AUDIO is ON in the SETUP MENU, no sound will be heard on discs which are recorded with LPCM, DTS or MPEG-2.

- ◆ **How to make the SETUP MENU disappear or return to menu screen during set up:** Press RETURN button.
- ◆ Certain audio features of this product manufactured under a license from Desper Products, Inc. Spatializer® and circle-in-square device are trademarks owned by Desper Products, Inc.
- ◆ Manufactured under license from Dolby Laboratories. "Dolby" and the double-D symbol are trademarks of Dolby Laboratories. Confidential unpublished works. ©1992-1997 Dolby Laboratories Inc. All rights reserved.
- ◆ "DTS" and "DTS Digital Out" are trademarks of Digital Theater Systems, Inc.

## Setting Up the Display Options

GB

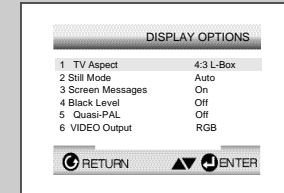

- 1 With no disc playing, press the SETUP button.
- 2 Use the ▲, ▼ button to select Display Options. Then press the ENTER button.
- 3 Use the ▲, ▼ button to select the desired item. Then press the ◀, ▶ button.

- 1 TV Aspect
  - 1 4:3 Letter Box : Select when you want to see the total 16:9 ratio screen DVD supplies, even though you have a TV with a 4:3 ratio screen. Black bars will appear at the top and bottom of the screen.
  - 2 4:3 Pan-Scan : Select this for conventional size TVs when you want to see the central portion of the 16:9 screen. (Extreme left and right side of movie picture will be cut off.)
  - 3 16:9 Wide : You can view the full 16:9 picture on your widescreen TV.
- 2 Still Mode
  - 1 Auto : When selecting AUTO, FIELD/FRAME mode will be automatically converted.
  - 2 Field : Select this feature when the screen shakes in the AUTO mode.
  - 3 Frame : Select this feature when you want to see small letters more clearly in the AUTO mode.
- 3 Screen Messages
 

Use to turn on-screen messages on or off.
- 4 Black Level
 

Adjusts the brightness of the screen.
- 5 Quasi-PAL
 

Depending on a disc, you can play a NTSC DVD disc by Quasi-PAL mode.
- 6 Video Output
  - 1 RGB : Sends RGB signal to the AV JACK(SCART terminal).
  - 2 Video : Sends COMPOSITE VIDEO signal to the AV JACK(SCART terminal).
  - 3 S-Video : Sends S-VIDEO signal to the S-JACK.

- ◆ **How to make the SETUP MENU disappear or return to menu screen during set up:** Press RETURN button.

## Technical Specifications

GB

<b>General</b>	Rated voltage	AC100 - 240V, 50/60Hz
	Power consumption	29Watts
	Weight	5.6Kg
	Size	430mm X 357mm X 100mm
	Operating ambient temperature	+5°C ~ +35°C
	Installation conditions	Operation position : Horizontal, Relative humidity :Below 75%
<b>Input</b>	Video input (Rear)	RCA jack : 1.0Vp-p (unbalanced) 75
	Audio input (Rear)	RCA jack :-8dBm, 47Kohm unbalanced
<b>Output</b>	RF out	UHF 21-69 (Initial CH60)
	Audio (DVD, VCR)	Headphones, RCA jack, Euro Scart socket
	Audio (DVD only)	Digital audio out (OPTICAL, COAXIAL)
	Video (DVD, VCR)	RCA jack, Euro Scart socket
	Video (DVD only)	S-Video out RGB out : Euro Scart socket
<b>VCR</b>	Tape format	VHS type video tape, S-VHS type video tape (Playback only)
	Color system	PAL, NTSC4.43, NTSC playback on PAL TV
	Tuning system	I
	Video S/N	Above 43dB (standard recording)
	Resolution	Above 240 lines (standard recording)
	Audio S/N	Above 68dB (Hi-Fi), 39dB (Mono)
<b>DVD</b>	Audio frequency characteristics	20Hz - 20KHz (Hi-Fi)
	Disc	DVD, CD (12cm), CD(8cm), VIDEO-CD (12cm)
	Audio S/N	115dB
	Audio dynamic range	105dB

## Problems and Solutions (VCR)

GB

*Before contacting the Samsung after-sales service, perform the following simple checks.*

Problem	Explanation/Solution
No power	<ul style="list-style-type: none"> <li>◆ Check that the power plug is connected to a wall outlet.</li> <li>◆ Have you pressed the STANDBY/ON button?</li> </ul>
You cannot insert a video cassette	<ul style="list-style-type: none"> <li>◆ A video cassette can only be inserted with the window side up and the safety tab facing you.</li> </ul>
The television programme was not recorded	<ul style="list-style-type: none"> <li>◆ Check the DVD-VCR aerial connections.</li> <li>◆ Is the DVD-VCR tuner properly set?</li> <li>◆ Check if the safety tab is intact on the cassette.</li> </ul>
Timer recording was unsuccessful	<ul style="list-style-type: none"> <li>◆ Was the STANDBY/ON button pressed to activate the timer?</li> <li>◆ Re-check the recording start/stop time settings.</li> <li>◆ If there was a power failure or interruption during timer recording, the recording will have been cancelled.</li> </ul>
No playback picture or the picture is distorted	<ul style="list-style-type: none"> <li>◆ Check to see if you are using a prerecorded tape.</li> </ul>
You cannot see normal broadcasts	<ul style="list-style-type: none"> <li>◆ Check the TUNER/EXTERNAL setting. It should be on TUNER.</li> <li>◆ Check the TV/VCR aerial connections.</li> </ul>
Noise bars or streaks on playback	<ul style="list-style-type: none"> <li>◆ Press the TRK (+or -) buttons to minimize this effect.</li> </ul>
When the ►   button is pressed during playback, the still picture has severe "noise bars" streaks	<ul style="list-style-type: none"> <li>◆ A still picture may have "noise bars", depending on the condition of the tape. Press the TRK (+or -) buttons during SLOW motion to minimize this effect.</li> </ul>
Video Head Cleaning	<ul style="list-style-type: none"> <li>◆ If poor pictures appear on a variety of cassettes, the video heads may need cleaning. This is not a common problem and unless it appears, the heads should not be cleaned. When cleaning the video heads, read all instructions provided with the head cleaning cassette. Incorrect head cleaning can permanently damage the video heads.</li> </ul>
If when tuning in your TV to the DVD-VCR your TV does not find the screen or the screen when found suffers from interference, it may be due to the DVD-VCR output channel clashing with the normal TV transmissions in your area. To prevent this you will need to change the DVD-VCR output channel in the following way	<ol style="list-style-type: none"> <li>1. Remove the aerial input plug from the socket marked (aerial symbol) on the rear of the DVD-VCR.</li> <li>2. Carry out the instructions "Tuning Your Television for the DVD-VCR" (see page 14).</li> <li>3. Carry out the instructions "Setting the DVD-VCR output Channel" (see page 19), move the channel number several channels down from the original setting. (example: from 60 to 57).</li> <li>4. Replace the aerial plug into the socket marked (aerial symbol) on the rear of the DVD-VCR.</li> <li>5. Re-tune your TV to the DVD-VCR again by following instructions "Tuning Your Television for the DVD-VCR" (page 14).</li> <li>6. If the problem still exists repeat steps 1 to 5 moving several more channels away from the original setting.</li> </ol>

*If you are unable to solve the problem after reading the above instructions, note:*

- ◆ *The model and serial number on the rear of your DVD-VCR*
- ◆ *The warranty information*
- ◆ *A clear description of the problem*

*Then contact your nearest SAMSUNG after-sales service.*

# Troubleshooting Guide (DVD)

## SAMSUNG ELECTRONICS (UK) LTD AUTHORISED SERVICE CENTERS

In the event of warranty service being required, please contact your retailer first. If they cannot provide service, please contact your nearest service centre listed below. Service facilities are return to base, however some agents may provide an in-home service (there may be a cost for call out). Please refer to your warranty card or retailer for terms and conditions of the warranty.

### Before requesting service (troubleshooting)

Problem	Action	Page
Disc does not play.	<ul style="list-style-type: none"> <li>◆ Ensure that the disc is installed with the label side facing up.</li> <li>◆ Check the region number of the DVD.</li> <li>◆ This player cannot play CD-ROMs, DVD-ROMs, CD-RW, etc. Insert a DVD, a VIDEO-CD or a CD.</li> </ul>	P45
5.1 channel sound is not being reproduced.	<ul style="list-style-type: none"> <li>◆ 5.1 channel sound is reproduced only when the following conditions are met. :                             <ol style="list-style-type: none"> <li>1)The DVD-VCR player is connected with the proper amplifier</li> <li>2) The disc is recorded with 5.1 channel sound.</li> <li>3) The "Dolby Digital out" is selected "Bitstream".</li> </ol> </li> <li>◆ Check whether the disc being played has the "Dolby 5.1 ch" mark on the outside.</li> <li>◆ Check if your audio system is connected and working properly.</li> </ul>	P46 P62
The  icon appears on screen.	<ul style="list-style-type: none"> <li>◆ The features or action cannot be completed at this time because:                             <ol style="list-style-type: none"> <li>1. The DVD's software restricts it.</li> <li>2. The DVD's software doesn't support the feature (e.g., angles).</li> <li>3. The feature is not available at the moment.</li> <li>4. You've requested a title or chapter number or search time that is out of range.</li> </ol> </li> </ul>	P49-52 P54-58
Playback mode differs from the Setup Menu selection.	<ul style="list-style-type: none"> <li>◆ Some of the functions selected in the Setup Menu may not work properly if the disc is not encoded with the corresponding function.</li> </ul>	P58-63
The screen ratio cannot be changed.	<ul style="list-style-type: none"> <li>◆ The Screen Ratio is fixed on your DVDs.</li> </ul>	P63
No audio.	<ul style="list-style-type: none"> <li>◆ Make sure you have selected the correct Digital Output in the Audio Options Menu.</li> </ul>	P62
Forgot password	<ul style="list-style-type: none"> <li>◆ Press power on from a cold start with no disc in the unit. Press the <b>▶▶</b> and <b>▶  </b> buttons simultaneously on the front panel for five seconds. The Select Menu Language display will appear. Select the desired language button. Press the SETUP button on the remote control to select the Parental Mode. The Parental Mode is now unlocked as indicated on the display. Press the DOWN button to select Parental. Press ENTER and the Create Password display will appear. You can now set your rating level and change your password to a new number.</li> </ul>	P61
If you experience other problems.	<ul style="list-style-type: none"> <li>◆ Go to the contents and find the section of the instruction book that contains the explanations regarding the current problem, and follow the procedure once again.</li> <li>◆ If the problem still cannot be solved, please contact your nearest authorized service center.</li> </ul>	

<b>AVON</b> BRISTOL GOGGLEBOX TV TEL: 01275 838083  <b>BERKSHIRE</b> READING A & W SOUND & VISION TEL: 01734 872000 MAIDENHEAD J F ASSOCIATES TEL: 01628 25709 WARGRAVE J F ASSOCIATES TEL: 01734 401525  <b>CAMBRIDGESHIRE</b> DRY DRAYTON DRAYTON ELECTRONICS TEL: 01954 211330 PETERBOROUGH DEEPIG TV SVCS TEL: 01778 343831  <b>CHESHIRE</b> CHESTER H & H VIDEO & TV TEL: 01244 378579 WARRINGTON W L ELECTRONICS TEL: 01925 764387  <b>CORNWALL</b> BUDE H B H WOOLACOTTS TEL: 01288 352269 LAUNCESTON H B H WOOLACOTTS TEL: 01566 772096 NEWQUAY GREENBANK ELECTRONICS TEL: 01637 880576 WADEBRIDGE H B H WOOLACOTTS TEL: 01208 816155  <b>CUMBRIA</b> BARROW IN FURNESS KENNETH GARDNER TEL: 01229 821202 SEARLE AUDIO TEL: 01229 839692 PENRITH CANNAN & BROWN TEL: 01768 864829  <b>DEVON</b> HOLSWORTHY H B H WOOLACOTTS TEL: 01409 253280 NEWTON ABBOT TELLI-SCOPE ELECTRONICS TEL: 01626 63907 PLYMOUTH ARGYLE TV & VIDEO TEL: 01752 779933 CTV ELECTRONICS TEL: 01752 350950  <b>DORSET</b> BOURNEMOUTH M & G ELECTRONICS TEL: 01202 523771  <b>DURHAM</b> DURHAM LEE TECH SVCS TEL: 0191 371 1300 DARLINGTON GAZE ELECTRONICS TEL: 01325 482344  <b>DYFED</b> CARMARTHEN ADVANCE CONSUMER TEL: 01267 236143 ST CLEARS BEN EVANS & SON TEL: 01994 231015  <b>ESSEX</b> BRAINTREE GWYNNE TV & ELECTRICAL TEL: 01376 322567	<b>WICKFORD</b> CENTRAL SERVICE TEL: 01268 766333  <b>MID GLAMORGAN</b> BRIDGEND BRIDGEND SERVICE TEL: 01656 663463  <b>GLOUCESTERSHIRE</b> TEWKESBURY SWITCH ELECTRONICS TEL: 01684 850663 WESTON-SUB-EDGE PROFESSIONAL ELECTRONIC TEL: 01386 841773  <b>HAMPSHIRE</b> FAREHAM SOUND & VISION TEL: 01329 296651 FARNBOROUGH ICTV TEL: 01252 510118 PORTSMOUTH ICTV TEL: 01705 653654 SOUTHAMPTON OLYMPIC TV & AUDIO TEL: 01703 703401 WATTON JULIAN HORN TEL: 01953 881440  <b>HEREFORD</b> HEREFORD J P MICRO SVCS TEL: 01432 356353  <b>HERTFORDSHIRE</b> BALDOCK TECHNICAL REPAIR SVC TEL: 01462 491144 MARKYATE TELETECH SVCS TEL: 01582 841862  <b>NORTH HUMBERSIDE</b> GOOLE HEADLAND ELECTRCRS TEL: 01977 661223  <b>SOUTH HUMBERSIDE</b> GRIMSBY RAYNERS SUPERSTORE TEL: 01472 358766  <b>KENT</b> CANTERBURY BARRETT'S OF CANTERBURY TEL: 01227 766582 DARTFORD BUDGET REPAIR CENTRE TEL: 01322 227668 MAIDSTONE AVERY ELECTRONICS TEL: 01622 682138  <b>LANCASHIRE</b> BLÄCKPOOL KENNETH GARDNER TEL: 01253 824047 LANCASTER KENNETH GARDNER TEL: 01524 64468 ROCHDALE CTV SERVICES TEL: 01706 654983  <b>LEICESTERSHIRE</b> LEICESTER SOUND & VISION CENTRE TEL: 01162 730444  <b>LINCOLNSHIRE</b> BRANSTON STUART WALLACE TEL: 01522 791496  <b>LONDON</b> HIGH HOLBORN BERRY'S OF HOLBORN TEL: 0171 405 1157  <b>LONDON</b> ARMSTRONG SERVICES TEL: 0181 523 0023/0051 WEST EALING BABBER ELECTRONICS TEL: 0181 579 6315	<b>LONDON</b> WILLESDEN ATLANTIC ELECTRIC TEL: 0181 451 6155  <b>MANCHESTER</b> ASHTON UNDER LYNE VIDEOTECH UK TEL: 0161 308 4092 NORTHENDEN G H SUMNER LTD TEL: 0161 998 2705  <b>MERSEYSIDE</b> ELLSMERE PORT H & H VIDEO & TV TEL: 0151 357 1011 LIVERPOOL P & A AUDIO VIDEO LTD TEL: 0151 924 7287  <b>MIDDLESEX</b> HAYES A & A REPAIRS TEL: 0181 561 2900/4104  <b>NORFOLK</b> AYLESHAM CORTONS ELECTRICAL TEL: 01263 733391 WATTON JULIAN HORN TEL: 01953 881440  <b>NORTHAMPTONSHIRE</b> KETTERING INTEGRATED SVCS TEL: 01536 516475  <b>OXFORDSHIRE</b> BANBURY HITECH TEL: 01295 267415 BOTLEY SPECTRUM ELECTRON TEL: 01865 250199  <b>SHROPSHIRE</b> TELFORD W OWEN TEL: 01952 613818  <b>SOMERSET</b> TAUNTON ARITECH ELECTRONICS TEL: 01823 279401 YEovil M J THOMAS TEL: 01935 477255  <b>STAFFORDSHIRE</b> STOKE ON TRENT TELEFAULTS (S.O.T.) LTD TEL: 01782 813757  <b>SUFFOLK</b> IPSWICH GGM LTD TEL: 01473 744300  <b>SURREY</b> WALLINGTON SERVICECARE TEL: 0181 669 1145 HORSLEY D K AUDIO VISUAL SVCS TEL: 01293 786459  <b>EAST SUSSEX</b> SEAFORD CLEARVIEW RENTAL & RELAY TEL: 01323 898989 EASTBOURNE STARTEC SVCS TEL: 01323 412012  <b>TYNE &amp; WEAR</b> NEWCASTLE UPON TYNE M SINGH RADIO & TV TEL: 0191 226 0446  <b>WEST MIDLANDS</b> COVENTRY D & J HENRY TEL: 01203 431393	<b>WEST MIDLANDS</b> DUDLEY J S STOREY ELECTRICAL TEL: 01384 455608 WALSALL BEAVER ELECTRONICS TEL: 01922 725554 WARLEY MERRIVALE TV SVCS TEL: 0121 544 6273/6350  <b>WILTSHIRE</b> SWINDON COLORITE TV LTD TEL: 01793 641038  <b>WORCESTERSHIRE</b> WORCESTER THE HI FI CAR RADIO REPAIR TEL: 01905 26623  <b>SOUTH YORKSHIRE</b> SHEFFIELD GRAPHIC ELECTRONIC SVCS TEL: 0114 256 2791 BARNLEY ALTRA TEL: 01226 207434  <b>NORTH YORKSHIRE</b> YORK DBS SERVICE CENTRE TEL: 01904 789789  <b>WEST YORKSHIRE</b> BRADFORD GRAPHICK ELECTRON TEL: 01274 802267 HUDDERSFIELD GRAPHIC ELECTRONICS TEL: 01484 451045 ILKLEY R BEAUMONT TEL: 01943 607021  <b>CHANNEL ISLANDS</b> GUERNSEY TELESKILL LTD TEL: 01481 56508 JERSEY ALTERNATIVE ELECT TEL: 01534 68277 ISLE OF WIGHT AUDIO VISION SVCS TEL: 01983 752023  <b>NORTHERN IRELAND</b> CO ARMAGH CRAIGAVON TV SVCS TEL: 0762 326119/322505  <b>EIRE</b> CO CORK TVAE REPAIRS TEL: 00353 21 273457  <b>GRAMPIANS</b> FRASERBURGH RODGERS ELECTRICAL TEL: 01346 516540  <b>HIGHLANDS</b> ULLAPool R & R ELECTRONICS TEL: 01854 612608  <b>LOTHIAN</b> EDINBURGH RETEC AUDIO & VISUAL TEL: 0131 478 7779  <b>STRATHCLYDE</b> GLASGOW DSC ELECTRONICS TEL: 0141 941 3711  <b>TAYSIDE</b> DUNDEE ANCRUM ELECTRONICS TEL: 01382 454511
--	---	--	--



THIS APPLIANCE IS DISTRIBUTED BY

