

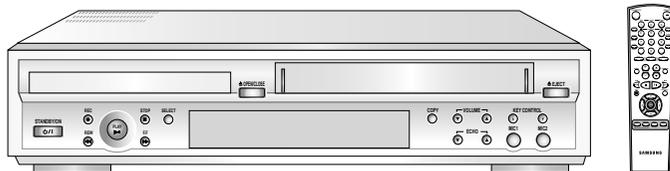

DVD-VCR

DVD-V5000K

Instruction Manual



Safety Precautions

	CAUTION RISK OF ELECTRIC SHOCK DO NOT OPEN	
<p>CAUTION. TO REDUCE THE RISK OF ELECTRIC SHOCK, DO NOT REMOVE REAR COVER. NO USER SERVICEABLE PARTS INSIDE. REFER TO QUALIFIED SERVICE PERSONNEL.</p>		

 **DANGER**

This symbol is intended to alert you to the presence of dangerous voltage within the product.

 **CAUTION**

This symbol is intended to alert you to the presence of important instructions accompanying the product.

Contents

- ◆ FOREWORD
 - Safety Instructions 5
- ◆ DVD-VCR OVERVIEWS
 - Front View of the DVD-VCR..... 6
 - Rear View of the DVD-VCR..... 6
 - Infrared Remote Control..... 7
 - Display Indicators 8
 - Accessories 8
- ◆ CONNECTING YOUR DVD-VCR
 - Deciding How to Connect DVD-VCR..... 9
 - Connecting DVD-VCR to the TV using the RCA Cable..... 10
 - Connecting the Audio Output Cable 10
 - Deck Control Keys..... 11
 - Copying from DVD to VCR 12
- ◆ SETTING UP YOUR DVD-VCR
 - Inserting Batteries in the Remote Control..... 13
 - Setting the Date and Time..... 13
 - Displaying/Hiding On-Screen Information 14
- ◆ RECORDING
 - Selecting the Cassette Type..... 14
 - Protecting a Recorded Cassette..... 15
 - Connecting an RCA Audio/Video Input Cable 15
 - Recording from Another VCR or Camcorder..... 16
 - Recording a Programme with Automatic Stop..... 16
- ◆ PLAYING BACK
 - Playing a Cassette..... 17
 - Adjusting Picture Alignment Manually 17
 - Intelligent Picture Control 18
 - Selecting the Colour Mode 18
 - Selecting the Audio Output Mode..... 19
- ◆ SEARCHING FOR A SEQUENCE
 - Playing a Cassette in Slow Motion 20
 - Playing a Sequence Frame by Frame 21
 - Playing a Sequence at Variable Speeds 21
 - Auto Repeat Play 22
 - Interval Repeat Play 22
 - Using the Tape Counter 23
- ◆ KARAOKE FEATURES
 - Using the KARAOKE Function (VCR) 24
 - SCORE Function (VCR) 24
 - KARAOKE SEARCH Function (VCR) 24
- ◆ OTHER FUNCTIONS AND USEFUL RECOMMENDATIONS
 - Auto Power Off 25



Contents (cont.)

◆ DVD FUNCTIONS	
■ Disc Type and Characteristics.....	26
■ Choosing a Connection	27
■ Playing a Disc.....	28
■ Using the Search & Skip Functions.....	29
■ Using the Display Function (DVD).....	30
■ Using the Display Function (CD/VCD).....	30
■ Repeat Play.....	31
■ Program Play (DVD/VCD/CD).....	32
■ Random Playback (DVD/VCD/CD).....	32
■ Using the Disc View Function (Track View VCD).....	33
■ Using the Disc View Function (Index View VCD).....	33
■ Selecting the Audio Language (Using the AUDIO button).....	34
■ Selecting the Subtitle Language (Using the SUBTITLE button).....	34
■ Changing the Camera Angle.....	35
■ Using the Mark Function (DVD/VCD).....	36
■ Recalling a Marked Scene.....	36
■ Clearing a Mark.....	36
■ Using the Zoom (DVD/VCD).....	37
■ 3D Sound Function.....	37
■ S.FIT PLAY.....	38
◆ KARAOKE FUNCTIONS	
■ Beginning Karaoke Functions.....	38
■ Key Control.....	38
■ Reserving a Song.....	39
■ Cancellation of reservation.....	39
■ Vocal Fader.....	40
■ Guide Melody.....	40
■ Score Function.....	40
■ Types of Karaoke disc.....	40
◆ DVD FUNCTIONS	
■ Using the Setup Menu.....	41
■ Setting Up the Language Features.....	42
■ Using the Disc Menu Language.....	42
■ Setting Up the AUDIO Language Features.....	43
■ Using the Subtitle Language.....	43
■ Setting Up the Parental Control.....	44
■ Setting Up the Audio Options.....	45
■ Setting Up the Display Options.....	46
◆ Technical Specifications.....	47
◆ SOLVING PROBLEMS	
■ Problems and Solutions (VCR).....	48
■ Troubleshooting Guide (DVD).....	49

Symbols



Press/push



Hold down



Important



Note

① = Step number

Safety Instructions

The following illustrations represent precautions.



The lightning bolt is a warning sign alerting you to dangerous voltage inside the product.
DO NOT OPEN THE DVD-VCR. Refer to service personnel.

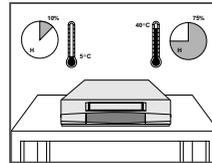

Do NOT expose the DVD-VCR to extreme temperature conditions (below 5°C and above 40°C) or to extreme humidity conditions (less than 10% and more than 75%).

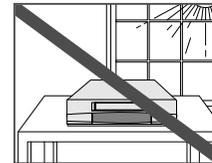

Do NOT expose the DVD-VCR to direct sunlight.

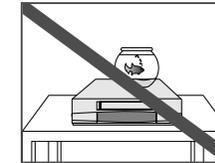

Do NOT expose the DVD-VCR to any liquids.

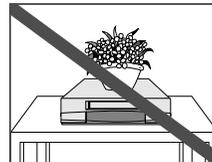

Do NOT place any objects on the DVD-VCR or remote control.

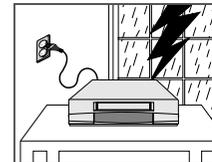

During a storm and/or lightning, unplug the DVD-VCR from the mains socket and aerial.

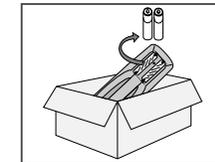

If the remote control is not used for a long period of time, remove the batteries and store it in a cool, dry place.

THIS DEVICE IS NOT FOR USE IN INDUSTRIAL ENVIRONMENTS

Front View of the DVD-VCR

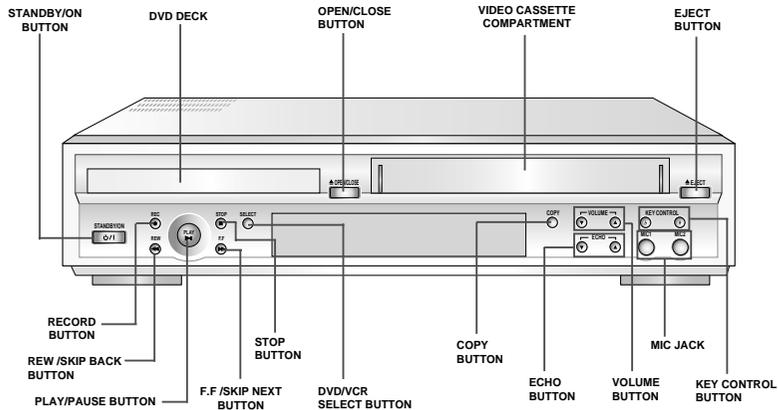

Rear View of the DVD-VCR

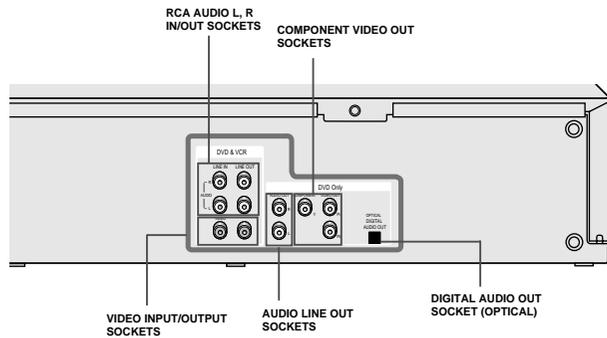

Infrared Remote Control

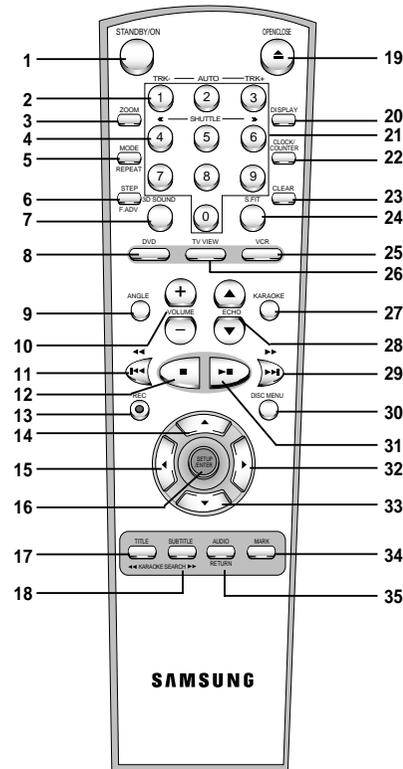

- 1 STANDBY/ON
- 2 AUTO TRACKING/TRACKING +/-
- 3 ZOOM
- 4 SHUTTLE <</>
- 5 MODE/REPEAT
- 6 STEP/F. ADV
- 7 3D SOUND
- 8 DVD
- 9 ANGLE
- 10 MIC VOL
- 11 REWIND/SKIP BACK
- 12 STOP
- 13 RECORD
- 14 UP
- 15 LEFT
- 16 SETUP/ENTER
- 17 TITLE/KARAOKE SEARCH <<
- 18 SUBTITLE/KARAOKE SEARCH >>
- 19 OPEN/CLOSE
- 20 DISPLAY
- 21 0-9
- 22 CLOCK/COUNTER
- 23 CLEAR
- 24 S.FIT
- 25 VCR
- 26 TV VIEW
- 27 KARAOKE
- 28 ECHO VOL
- 29 FAST-FORWARD/SKIP NEXT
- 30 DISC MENU
- 31 PLAY/PAUSE
- 32 RIGHT
- 33 DOWN
- 34 MARK
- 35 AUDIO/RETURN

➤ Function Buttons:

- ◆ **TV VIEW** : Output selection key. Select the output that you want to see.
- ◆ **DVD** : Remote key active for DVD operation.
If you press DVD button, the **DVD** is lightening. It means DVD mode.
ex) If you press **▶II** (PLAY) key, the DVD will be play.
- ◆ **VCR** : Remote key active for VCR operation.
If you press VCR button, the **VCR** is lightening. It means VCR mode.
ex) If you press **▶II** (PLAY) key, the VCR tape will be play.
- ◆ **DISC MENU** : Use for DISC menu of DVD.
- ◆ **SETUP** : Use for SETUP menu of DVD or VCR.

Display Indicators

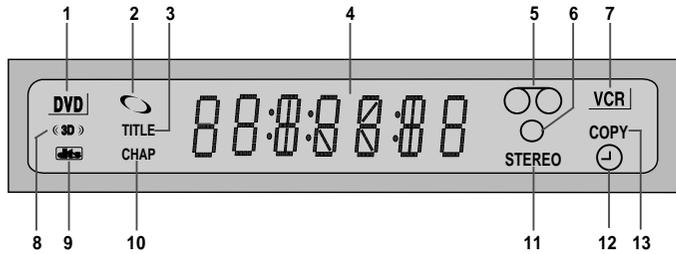

- | | |
|--|--|
| 1 The DVD Deck is active | 11 The STEREO track of a VHS tape is playing |
| 2 The status of the DVD deck is graphically displayed | 12 A Timer Recording is programmed or in progress. |
| 3 The number to the right of the "TITLE" symbol is the current title number | 13 DVD to VHS copy is in progress |
| 4 The time, counter position, time remaining or current deck status is displayed | |
| 5 The status of the VCR deck is graphically displayed | |
| 6 REC mode | |
| 7 The VCR Deck is active | |
| 8 3D Sound is active | |
| 9 A DVD with a DTS soundtrack is loaded | |
| 10 The number to the right of the "CHAP" symbol is the current title number | |

Accessories

You have just purchased a SAMSUNG Video Cassette Recorder (DVD-VCR). Together with your DVD-VCR, you will find the following accessories in the box.

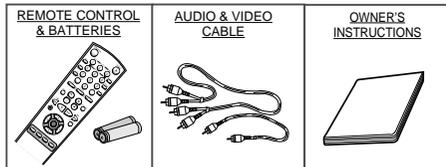

Deciding How to Connect DVD-VCR

You must take into account various factors when connecting audio or video systems:

- ◆ *Types of connectors available on your systems*
- ◆ *Systems connected permanently to the DVD-VCR (satellite receiver for example) or temporarily (camcorder for example)*

Your DVD-VCR is equipped with the following connectors.

Connector	Location	Type	Direction	Recommended Use
Audio input	Rear	Audio RCA	In ⊖	◆ LINE Audio in
Audio output		Audio RCA	Out ⊕	◆ LINE Audio out
VIDEO input	Rear	RCA	In ⊖	◆ LINE Video in
VIDEO output		RCA	Out ⊕	◆ LINE Video out
Digital AUDIO output	Rear	Optical	Out ⊖	◆ Digital Audio out (DVD only)



Whenever you connect an audio or video system to your DVD-VCR, ensure that all elements are switched off.

Refer to the documentation supplied with your equipment for detailed connection instructions and associated safety precautions.

Connecting DVD-VCR to the TV using the RCA Cable

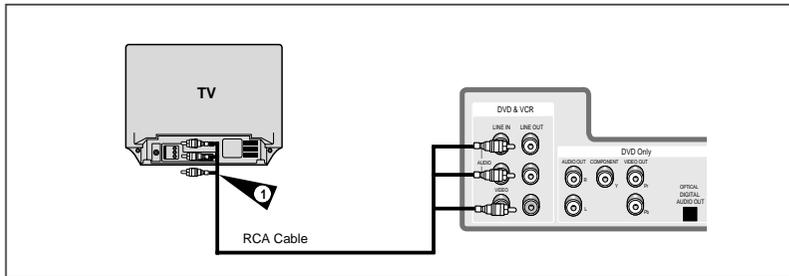

You can connect your DVD-VCR to the television using the RCA cable if the appropriate input is available on the television. You thus:

- ◆ Obtain better quality sound and pictures
- ◆ Simplify the setting up procedure of your DVD-VCR

Make sure that both the television and the DVD-VCR are switched off before connecting the cables.

- 1 Connect one end of the RCA cable to the LINE OUT on the rear of the DVD-VCR.
- 2 Plug the other end into the appropriate connector on the television.

Connecting the Audio Output Cable

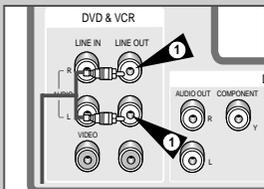

You can connect your DVD-VCR to a Hi-Fi system.

Example: You wish to take advantage of the quality of your Hi-Fi stereo system when watching a programme or recording via your DVD-VCR.

Make sure that both the television and the DVD-VCR are switched off before connecting the cables.

- 1 Plug the audio output cable into the audio connectors on the rear of your DVD-VCR.
 - Respect the colour coding of the left and right channels.
- 2 Plug the other end of the audio cable into the appropriate input connectors on your Hi-Fi stereo system.

Deck Control Keys

The DVD-VCR uses one set of controls to operate **both** decks. The following keys are helpful in successfully controlling each deck.

- 1 **STANDBY/ON Button**
Press the STANDBY/ON button on the remote control or front panel to turn on the DVD-VCR.
- 2 **DVD Button**
Press the DVD button on the remote control when you want to control the DVD deck.
 - ◆ The DVD indicator will light on the Front Panel Display to show that the DVD deck is selected.
- 3 **VCR Button**
Press the VCR button on remote control when you want to control the VCR deck.
 - ◆ The VCR indicator will light on the Front Panel Display to show that VHS deck is selected.
- 4 **DVD-VCR Toggle**
Press the SELECT button on the front panel to toggle control between the DVD deck and the VCR deck.
- 5 **The TV VIEW Key**
Press the TV-VIEW button on the remote control to toggle control between the DVD and VCR.

➤ TV-VIEW function cannot work at the search, still and copy mode.

➤ Before using the VCR operation of 10~25 pages, press the VCR button on the remote control to select VCR mode.

Before using the DVD operation of 26~46 pages, press the TV VIEW button on the remote control to select and watch DVD.

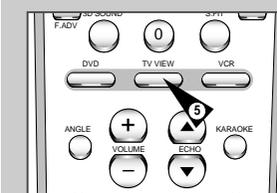
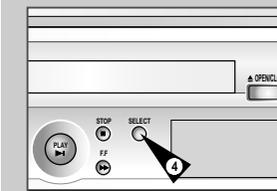
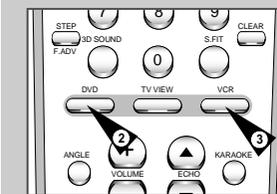
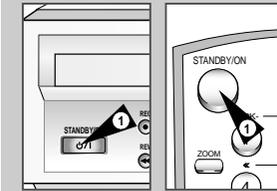

Copying from DVD to VCR

GB

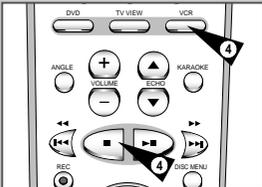
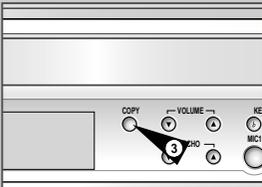
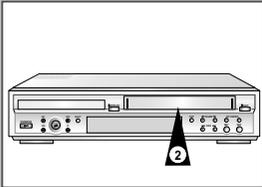
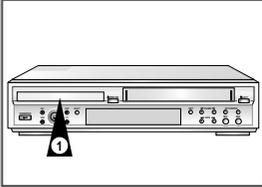

The DVD-VCR allows you to copy the contents of a DVD to a VHS tape with a press of the COPY button.



If the DVD you are attempting to copy is copy protected, you will not be able to copy the disc. It is not permitted to copy Macrovision® encoded DVDs.

- 1 Insert Disc**
Insert the disc you wish to copy in the DVD deck and close the drawer.
- 2 Insert VHS Tape**
Insert a blank VHS videotape into the VCR deck.
- 3 Copy the DVD to VHS Tape**
Press the COPY button on the DVD-VCR front panel.
 - ◆ The DVD will go into Play mode and the VCR will go into Record mode.
 - ◆ If the DVD disc menu appears, you may need to press the PLAY button manually to begin copying.
- 4 Stop the Copy Process**
When the DVD is finished playing, press the VCR button on the remote control and then press the STOP button to end the copy.
 - ◆ You must stop the Copy process manually when the DVD movie ends or the DVD may replay and record over and over again.

Inserting Batteries in the Remote Control

You must insert or replace the batteries in the remote control when you:

- ◆ Purchase the DVD-VCR
- ◆ Find that the remote control is no longer working correctly

- 1 Push the tab in the direction of the arrow to release the battery compartment cover on the rear of the remote control.
- 2 Insert two AA, R6 or equivalent batteries, taking care to respect the polarities:
 - ◆ + on the battery with + on the remote control
 - ◆ - on the battery with - on the remote control
- 3 Replace the cover by aligning it with the base of the remote control and pushing it back into place.

➤ Do not mix different battery types (manganese and alkaline for example).

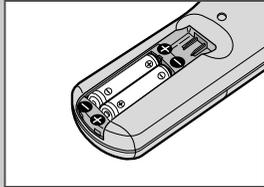
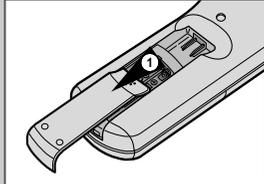

Setting the Date and Time

You must set the date and time when:

- ◆ You purchase the DVD-VCR
 - ◆ The power supply remains off for more than 60 seconds
- Do not forget to reset the time when you change clocks from winter to summer time and vice versa.

- 1 Press SETUP on the remote control.
Result: The programming menu is displayed.
- 2 Press the corresponding ◀ or ▶ buttons to select the CLOCK SET option.
- 3 Press the ENTER button to select this option.
Result: The CLOCK SET menu is displayed.
- 4 Press ◀ or ▶ to select the hour, minutes, day, month and year.
Result: The option selected flashes.
- 5 Press the ▲ or ▼ buttons to increase or decrease the value.
Result: The day of the week is displayed automatically.
➤ You can hold the ▲ or ▼ buttons down to scroll more quickly through the values.
- 6 On completion, press RETURN twice to exit the menu.

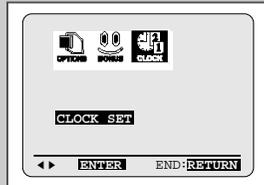

Displaying/Hiding On-Screen Information

Your DVD-VCR displays most information both on the DVD-VCR and the television.

You can choose to display or hide this information on the television screen.

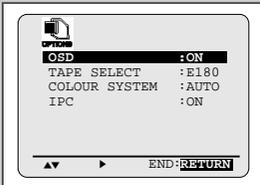

- 1 Press SETUP on the remote control.
Result: The programming menu is displayed.
- 2 Press the corresponding ◀ or ▶ buttons to select the **USER SET** option.
- 3 Press the ENTER button to select this option.
Result: The **USER SET** menu is displayed.
- 4 Press the corresponding ▲ or ▼ buttons, until the OSD option is selected.
- 5 To... **Press ◀ or ▶, until...**
Display on-screen information **ON** is displayed.
Hide on-screen information **OFF** is displayed.
- 6 On completion, press RETURN twice to exit the menu.

Selecting the Cassette Type

If you wish to use the tape counter to display the time remaining on a cassette, you must indicate the type of cassette inserted.

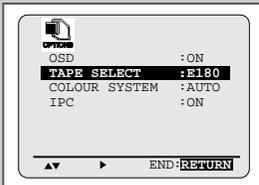
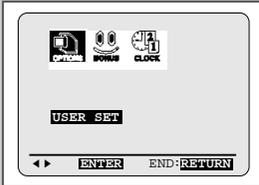

- 1 Press SETUP on the remote control.
Result: The programming menu is displayed.
- 2 Press the corresponding ◀ or ▶ buttons to select the **USER SET** option.
- 3 Press the ENTER button to select this option.
- 4 Press the corresponding ▲ or ▼ buttons, until the **TAPE SELECT** option is selected.
- 5 Press the ◀ or ▶ buttons as many times as required, until the correct cassette length is displayed.

→	E180	→	E240
	E 300	←	E260
- 6 Press RETURN twice to exit the menu.

Protecting a Recorded Cassette

Video cassettes have a safety tab to prevent accidental erasure. When this tab has been removed, you **cannot** record on the tape.

- 1 If you wish to protect a cassette, break off the tab using a small screwdriver.
- 2 To re-record over a protected cassette (safety tab broken), cover the hole with adhesive tape.

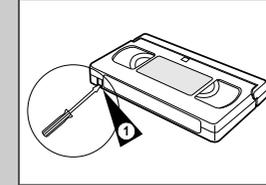

Connecting an RCA Audio/Video Input Cable

You can connect other audio/video equipment to your DVD-VCR using audio/video cables if the appropriate outputs are available on the equipment chosen.

- Examples:**
- ◆ You wish to copy a video cassette with the help of a second VCR (see page 16).
 - ◆ You wish to play back and/or copy pictures taken with a camcorder (see page 16).



- ◆ Make sure that both the television and the VCR are switched **off** before connecting the cables.

- 1 Connect one end of the RCA video cable into the VIDEO socket on the Rear of the VCR.
- 2 Plug the other end of the video cable into the appropriate output connector on the other system (VCR or camcorder).
- 3 Connect one end of the RCA audio cable into the AUDIO sockets on the Rear of the VCR.
 - Take care to respect the colour coding of the left and right channels.
- 4 Plug the other end of the audio cable into the appropriate output connectors on the other system (VCR, camcorder or Hi-Fi sound system).

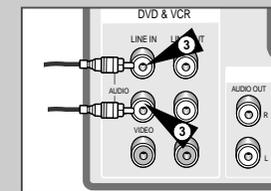
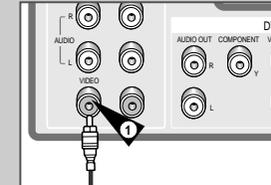

Recording from Another VCR or Camcorder

You can copy a cassette to your DVD-VCR from another video source, such as another VCR or a camcorder.

It is an infringement of copyright laws to copy prerecorded cassettes or to re-record them in any form without the permission of the owners of the corresponding copyright.

- 1 Connect the DVD-VCR, from which the cassette is to be copied, to the appropriate RCA audio and video input connectors on the rear of your DVD-VCR, as indicated on page 9.
- 2 Insert a blank cassette in your DVD-VCR.
- 3 Insert the pre-recorded cassette in the other video source (VCR or camcorder).
- 4 Start playing back the cassette to be copied.
- 5 Hold REC (●) down for a while to start recording on your DVD-VCR.
- 6 When you have finished recording, press ■ on both VCR and DVD-VCR.

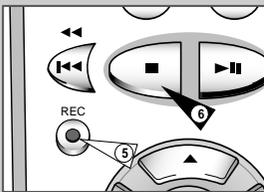
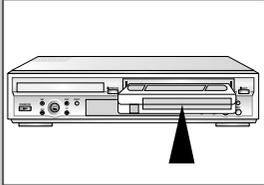

Recording a Programme with Automatic Stop

This function enables you to record up to five hours of programmes. Your DVD-VCR stops automatically after the requested length of time.

- 1 Switch on the television.
- 2 Insert the cassette on which the programme is to be recorded, with the window visible and the safety tab intact or the opening covered with adhesive tape.
Result: The DVD-VCR is switched on automatically.
- 3 Hold the REC button (●) down for a while to start recording.
Result: The record indicator appears on the television screen and DVD-VCR display.
- 4 Press the REC button (●) several times to increase the recording time in:
 - ◆ 30-minute intervals up to four hours
 - ◆ 1-hour intervals up to five hours**Result:** The length is displayed on the television displays. The selected programme is recorded for the length of time requested. At the end of that time, the DVD-VCR stops recording automatically.
- 5 If you wish to cancel the recording before the end, press STANDBY/ON.

If the end of the tape is reached while recording:

- ◆ The recording stops

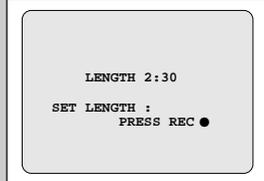
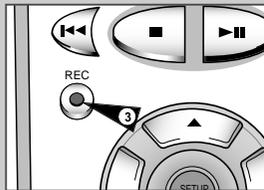
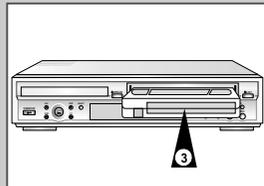

Playing a Cassette

This function allows you to play back any pre-recorded cassette.

- 1 Switch on both the television and your DVD-VCR.
- 2 Insert the video cassette to be played. If the safety tab on the cassette is intact, press ►II. Otherwise, the cassette is played automatically.
 - When a cassette is loaded, the tape position is optimized automatically to reduce disturbance (Digital Auto Tracking). When playing a cassette, if the end of the tape is reached, the cassette is rewound automatically.
- 3

To...	Then press...
Stop the playback	■ (STOP).
Eject the cassette	▲ (EJECT).

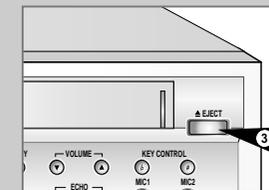
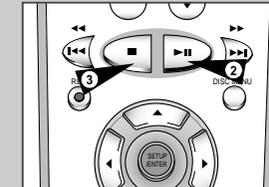

Adjusting Picture Alignment Manually

The Picture Adjustment feature allows you to adjust the alignment manually to obtain the best possible picture.

When noise bars or streaks appear during playback, adjust alignment manually by pressing the TRK (+ or -) buttons until the picture is clear and stable.

- Result:**
- ◆ The tracking bar appears.
 - ◆ The image is adjusted.
 - ◆ The tracking bar disappears when you release the button.



Intelligent Picture Control

The Intelligent Picture Control Feature allows you to adjust the sharpness of the image automatically, according to your own preferences.

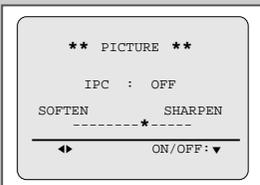
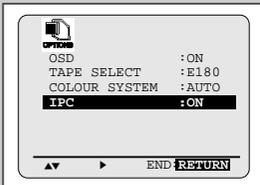

- 1 During playback, press the SETUP button on the remote control.
Result: The programming menu is displayed.
- 2 Press the corresponding ◀ or ▶ buttons to select the **USER SET** option.
- 3 Press the ENTER button to select this option.
Result: The **USER SET** menu is displayed.
- 4 Press the corresponding ▲ or ▼ buttons, until the **IPC** option is selected.
- 5 Press the ▶ button to select the IPC (intelligent picture control) option.
 - When intelligent picture control mode is **ON**, the sharpness of the image is adjusted automatically.
- 6 To adjust the sharpness manually, press the ▼ button to turn the IPC mode **OFF**.
- 7 Press the ◀ or ▶ buttons until the picture is displayed according to your preferences.
 - If you do not press a button within ten seconds, the **PICTURE** menu disappears automatically.
- 8 On completion, press the RETURN button again.

Selecting the Colour Mode

Before recording or playing back a cassette, you can select the required system standard.

Otherwise, the system automatically selects the reception standard when you select **AUTO**.

- ◆ When playing back a cassette, the standard is automatically selected by the DVD-VCR.
- ◆ When you playback an NTSC-recorded tape on this DVD-VCR make a setting on the colour system according to your TV. If your TV is a PAL system only TV, set NTPB. If your TV is Multi System TV (NTSC 4.43 compatible), set NT4.43 and you can record NT4.43.

- 1 Press SETUP on the remote control.
Result: The programming menu is displayed.
- 2 Press the corresponding ◀ or ▶ buttons to select the **USER SET** option.
- 3 Press the ENTER button to select this option.
Result: The **USER SET** menu is displayed.
- 4 Press the corresponding ▲ or ▼ buttons, until the **COLOUR SYSTEM** option is selected.
- 5 Press the ▶ button to select **AUTO** → **PAL** → **MESECAM** → **B/W**.

AUTO	When playing back a cassette, the system standard is automatically selected by the DVD-VCR.
B/W	Black and White
- 6 On completion, press RETURN twice to exit the menu.

Selecting the Audio Output Mode

You can select the mode in which the sound is reproduced on the loudspeakers and AV outputs. The following options are available.

Option	Description
L	Used to listen to the sound on the left Hi-Fi channel.
R	Used to listen to the sound on the right Hi-Fi channel.
MIX	Used to listen to the mixed sound of the Hi-Fi and normal channels.
MONO	Used to listen to the sound on the normal mono channel.
L R	Used to listen to Hi-Fi stereo sound on the left and right channels. <ul style="list-style-type: none"> ➤ When playing back tapes recorded in Hi-Fi, the sound switches to Hi-Fi after five seconds of Mono.

To select the sound mode, simply press the AUDIO button on the remote control until the required option is displayed.

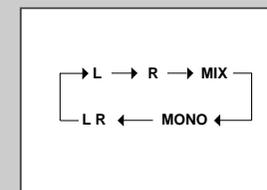
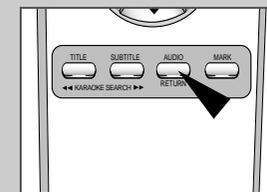

Playing a Cassette in Slow Motion

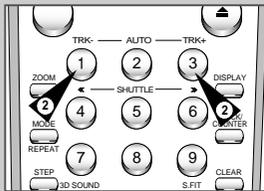
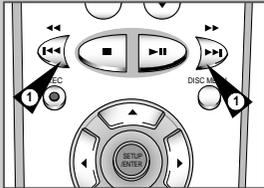

You can play a cassette in slow motion.

- No sound is heard when playing back a cassette in slow motion.

- 1 Press:
 - ◆ ▶|| to start playing the cassette
 - ◆ ▶|| button one more time to make STILL mode.
 - ◆ ▶▶ to start SLOW mode.
 - ◆ ▶▶ or ◀◀ button as many times as required to decrease or increase the speed respectively
 - ◆ To return to the normal speed, press the ▶|| button twice.

- 2 When playing back in slow motion, picture interference may occur. Press the TRK (+ or -) buttons to minimize this effect.

- When you have been using the Slow Motion function for more than about five minutes, the DVD-VCR will automatically play to protect the:
 - ◆ Cassette
 - ◆ Video heads

Playing a Sequence Frame by Frame

You can:

- ◆ Stop the cassette at a given frame (image)
- ◆ Advance one frame at a time

- No sound is heard when playing back frame by frame.

- 1 Press:
 - ◆ ▶|| to start playing the cassette
 - ◆ ▶|| to stop the tape at a given frame
 - ◆ F.ADV (STEP F.FWD) to advance frame by frame

- 2 To return to normal playback, press ▶||.

- When you have been using the Frame-by-Frame function for more than about five minutes, the DVD-VCR will automatically play to protect the cassette and video heads.

- Vertical stability: When playing back frame by frame, interference may be seen on the screen. Press the TRK (1, 3) buttons to minimize this effect.

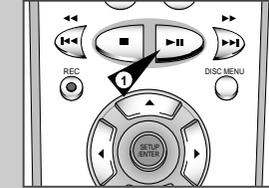

Playing a Sequence at Variable Speeds

You can vary the playback speed using the Shuttle function (up to nine times the normal speed).

Example: You wish to analyze a sportsperson's technique, movement by movement.

The Shuttle function is available on the Remote control

- No sound is heard when playing a sequence at variable speeds.

- 1 Press:
 - ◆ ▶|| during playback
 - ◆ SHUTTLE (<<) to play the cassette backwards
 - ◆ SHUTTLE (>>) to play the cassette forwards

- 2 Each time you press a SHUTTLE button, the speed is changed as shown in the following illustration.

REVERSE PLAY X9	REVERSE PLAY X7	REVERSE PLAY X3	STILL	SLOW MOTION X1/10	SLOW MOTION X1/5	PLAY X3	PLAY X7	PLAY X9
-----------------	-----------------	-----------------	-------	-------------------	------------------	---------	---------	---------

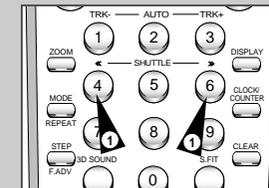

Auto Repeat Play

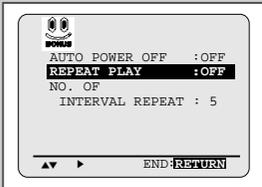
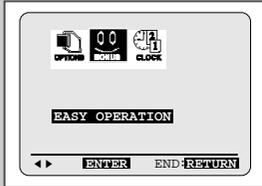

You can set repeat play to repeat the tape continuously from beginning to end.

- Press SETUP on the remote control.
Result: The programming menu is displayed.
- Press the corresponding ◀ or ▶ buttons to select the **EASY OPERATION** option.
- Press the ENTER button to select this option.
Result: The **EASY OPERATION** menu is displayed.
- Press the corresponding ▲ or ▼ buttons, until the **REPEAT PLAY** option is selected.
- To... Press ◀ or ▶, until...
Repeat play ON is displayed.
Do not wish to repeat play OFF is displayed.
- On completion, press RETURN twice to exit the menu.

Interval Repeat Play

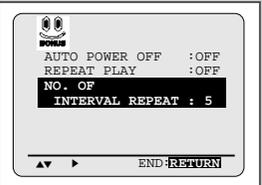
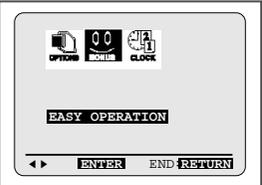

You can set Interval Repeat Play so that the cassette is repeated a number of times according to a specified set interval.

- Press SETUP on the remote control.
Result: The programming menu is displayed.
- Press the corresponding ◀ or ▶ buttons to select the **EASY OPERATION** option.
- Press the ENTER button to select this option.
Result: The **EASY OPERATION** menu is displayed.
- Press the corresponding ▲ or ▼ buttons, until the **NO. OF INTERVAL REPEAT** option is selected.
- To... Press ▶, until...
Interval Repeat Play 5, 10, 15 is displayed.
(choose an interval repeat of 5, 10 or 15 times)
Cancel Interval Repeat Play OFF is displayed.
- On completion, press RETURN twice to exit the menu.
- To select Interval Repeat Play during playback, press the REPEAT button at the desired start point.
Result: "INTERVAL REPEAT SETTING" is displayed.
Press the REPEAT button one more time at the desired end point.
Result: The tape is automatically rewound to the start point.
"INTERVAL REPEAT" is displayed.

Using the Tape Counter

The tape counter:

- Indicates the elapsed time in the play and record modes (hours, minutes and seconds)
- Is reset when a cassette is inserted in the DVD-VCR
- Allows you to find the beginning of a sequence easily

☞ If the remaining time is to be calculated correctly, you must indicate the type of cassette being used.

- Insert a cassette in your DVD-VCR.
- To set the tape counter to zero at the beginning of a sequence:
 - Press DISPLAY twice to display the counter
 - Press CLEAR when you want to set the tape counter to zero
- When you are ready,
 - Start playback or Recording
 - Press the ■ button
 - To fast-forward or rewind to the sequence at which the counter was set to zero, press ◀◀ or ▶▶.

➤ Some DVD-VCR information, such as the counter, can be displayed on the television screen (unless you have deactivated the OSD mode; refer to page 14).

Press DISPLAY:

- Once to display the current function, date, time and counter
- Twice to display the counter only
- Three times to display the time remaining on the cassette
- Four times to clear the display

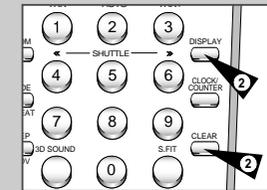
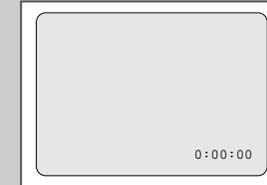

Using the KARAOKE Function (VCR)

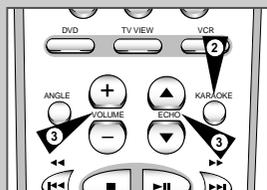

- 1 Press the STANDBY/ON button and insert KARAOKE tape.
- 2 Connect Mic into MIC1 or MIC2 jack. Then the KARAOKE mode is transferred "ON" mode.
 - ◆ Disconnect the Mic makes the KARAOKE mode transfer to "OFF" mode automatically.
 - ◆ Press the KARAOKE button on the remote control. Press the ◀ or ▶ button to select KARAOKE mode "ON".
- 3 To adjust the Mic volume and ECHO level, press the VOLUME and ECHO ▲ or ▼ keys.
- 4 To sing with accompaniment.

SCORE Function (VCR)

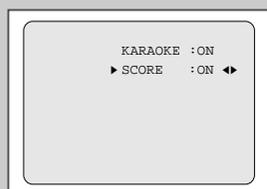

- 1 Press the KARAOKE button on the remote control.
- 2 Press the corresponding ▲ or ▼ buttons to select the SCORE mode.
- 3 Press the ◀ or ▶ buttons to select the SCORE mode "ON".
- 4 Score will pop up whenever a song is completed.

KARAOKE SEARCH Function (VCR)

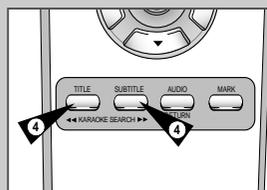

- 1 Press the STANDBY/ON button and insert KARAOKE tape.
- 2 Press the KARAOKE button to turn the KARAOKE mode ON.
- 3 Press ►II to start playing the cassette.
- 4 When you want the next song during playing a song, press the KARAOKE SEARCH ►► or KARAOKE SEARCH ◀◀ buttons on the remote control.

Auto Power Off

The Auto Power Off feature automatically turns off your DVD-VCR if no signal is received and you do not press any button for the selected time.

- 1 Press SETUP on the remote control.
Result: The programming menu is displayed.
- 2 Press the corresponding ◀ or ▶ buttons to select the **EASY OPERATION** option.
- 3 Press the ENTER button to select this option.
Result: The **EASY OPERATION** menu is displayed.
- 4 Press the corresponding ▲ or ▼ buttons, until the **AUTO POWER OFF** option is selected.
- 5 Press the ► button, until you select the time of Auto Power off interval.
►OFF ►2HOUR ►3HOUR
- 6 On completion, press RETURN twice to exit the menu.

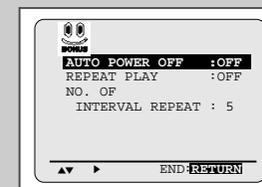
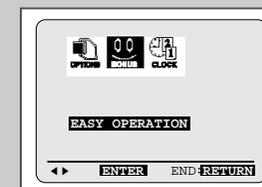

Disc Type and Characteristics

GB

This DVD player is capable of playing the following types of discs with the corresponding logos :

Disc Types (Logos)	Recording Types	Disc Size	Max. Playing Time	Characteristics
	Audio + Video	12 Cm	Single-sided 240 min. Double-sided 480 min.	<ul style="list-style-type: none"> DVD contains excellent sound and video due to Dolby Digital and MPEG-2 system. Various screen and audio functions can be easily selected through the on-screen menu.
		8 Cm	Single-sided 80 min. Double-sided 160 min.	
	Audio + Video	12 Cm	74 min.	<ul style="list-style-type: none"> Video with CD sound, VHS quality & MPEG-1 compression technology.
		8 Cm	20 min.	
	Audio	12 Cm	74 min.	<ul style="list-style-type: none"> An LP is recorded as an analog signal with more distortion, CD is recorded as a Digital Signal with better audio quality, less distortion and less deterioration of audio quality over time.
		8 Cm	20 min.	

* DO NOT play CD-ROM, CD-I and DVD-ROM in this player!
(CDGs play audio only, not graphics.)

Disc Markings



• Playback Region Number

PAL

• PAL colour system in U.K, France, Germany, etc.



• Dolby Digital disc

STEREO

• Stereo disc

DIGITAL SOUND

• Digital Audio disc



• DTS disc

Playback Region Number

Both the DVD player and the discs are coded by region. These regional codes must match in order for the disc to play. If the codes do not match, the disc will not play.

The Region Number for this player is described on the rear panel of the player.

Choosing a Connection

GB

The following show examples of connections commonly used to connect the DVD-VCR player with a TV and other components. It is only available for DVD. The VCR out can not watch by this connection.

Connection to an Audio System

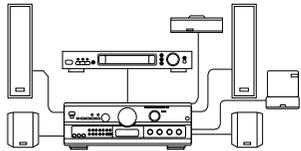

Dolby Digital Decoder
Digital Audio Input Jack

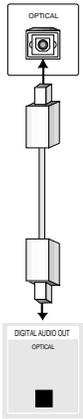

Digital Audio out
Jack

Connection Component Video Jack

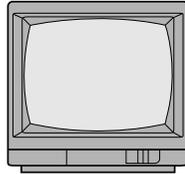

TV

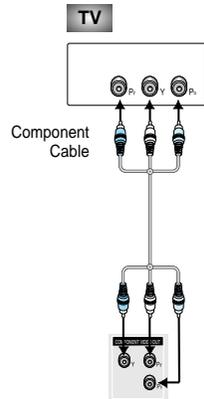

Component Video
Jacks

Playing a Disc

Before Playback :

- ◆ Turn on a TV and press the TV/VIDEO button to select video mode.
- ◆ Turn on your Audio System and select AUX, CD or DVD.
- ◆ Refer to your AUDIO User's Manual.

- 1 Press the OPEN/CLOSE button.
The STANDBY indicator light goes out and the tray opens.
- 2 Place a disc gently into the tray with the disc's label facing up.
- 3 Press the ►|| (PLAY/PAUSE) button or OPEN/CLOSE button to close the disc tray.

RESUME function :
When you stop disc play, the player remembers where you stopped, so when you press PLAY again, it will pick up where you left off (unless the disc is removed, the STOP button is pressed twice or the player is unplugged.).

- ◆ If the player is left for 5 minutes in pause mode, it will stop.
- ◆ This  icon indicates an invalid button press.

➤ **Before using the DVD operation, press the TV VIEW button on the remote control to watch and select DVD.**

- 1 Stopping Playback. Press the STOP button during playback.
- 2 Removing Disc. Press the OPEN/CLOSE button.
- 3 Pausing Playback.
Press the ►|| (PLAY/PAUSE) button on the remote during playback.
 - ◆ Screen stops, no sound.
 - ◆ To resume again, press ►|| (PLAY/PAUSE) button once again.
- 4 Step Motion Playback (Except CD)
Press the STEP button on the remote during pausing playback.
 - ◆ Each time the button is pressed, a new frame will appear.
 - ◆ No sound is heard during STEP mode.
 - ◆ Press ►|| (PLAY/PAUSE) to resume normal playback. (You can only perform step motion playback in the forward direction.)
- 5 Slow Motion Playback (Except CD)
Press the ► button on the remote during PAUSE or STEP mode.
 - ◆ By pressing the ► button, you can select slow motion playback for 1/2, 1/4 or 1/8 of normal speed.
 - ◆ No sound is heard during slow mode.
 - ◆ Press ►|| (PLAY/PAUSE) to resume normal playback.
 - ◆ When playing, the reverse slow motion playback will not work.

Using the Search & Skip Functions

During playback, you can search quickly through a chapter or track or use the skip function to jump to the next selection.

- 1 During playback, press the ►► or ◀◀ button on the remote.
 - ◆ Press the ►► or ◀◀ button on the remote and press again to search at a faster speed(2X/4X/8X/16X/32X/128X normal speed, in order) on the DVD.
 - ◆ Press the ►► or ◀◀ button on the remote and press again to search at a faster speed(2X/4X/8X/normal speed in order) on VCD and CD.
 - ◆ To return to normal speed playback, press the ►|| (PLAY/PAUSE) button.
- 2 During playback, press the ►|| (NEXT SKIP) or ◀◀ (BACK SKIP) button.
 - ◆ When playing a DVD, if you press the ►|| (NEXT SKIP) button, it moves to next chapter. If you press the ◀◀ (BACK SKIP) button, it moves to the beginning of the chapter. One more press makes it move to the beginning of the previous chapter.
 - ◆ When playing a VCD 2.0 in MENU OFF mode, a VCD 1.1 or a CD, if you press the ►|| (NEXT SKIP) button, it moves to next track. If you press the ◀◀ (BACK SKIP) button, it moves to the beginning of the track. One more press makes it move to the beginning of the previous track.
 - ◆ If a track exceeds 15 minutes when playing a VCD and you press the ►|| (NEXT SKIP) button, it moves forward 5 minutes. If you press the BACK SKIP button, it moves backward 5 minutes.
 - ◆ When playing a VCD 2.0 in the MENU MODE or Track View function, if you press the ►|| (NEXT SKIP) button, it moves to the next MENU or the next Track View display. If you press the ◀◀ (BACK SKIP) button, it moves to the previous MENU or the previous Track View display. (See page 33.)

- ◆ When in search mode (8X/16X/32X) on a DVD or high-speed playback on a VCD, no sound will be heard.
- ◆ When 2X SCAN AUDIO is set to ON in the SETUP MENU, no sound will be heard on discs which are recorded with LPCM, DTS or MPEG-2.
- ◆ Depending on the disc, audio may not be heard when a disc is in 2X playback mode.

DVD	2X, 4X, 8X, 16X, 32X, 128X
VCD	4X, 8X
CD	2X, 4X, 8X

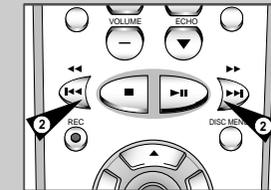
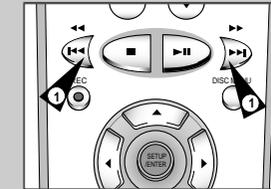
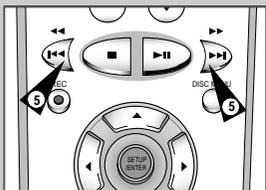
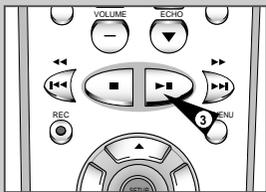
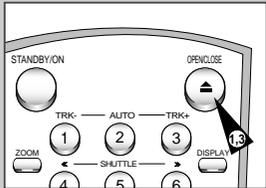

Using the Display Function (DVD)



- During playback, press the DISPLAY button on the remote.
 - Current title, chapter number and elapsed time will be displayed.
 - ◆ Use the ◀, ▶ button to select a title or a chapter number.
 - Use the ▲, ▼ button or Number buttons to enter a different title or chapter number, then press the ENTER button.
 - ◆ To enter the time from which you want to start, use the ◀, ▶ button to select, then use the Number buttons to enter the time. Then press the ENTER button.
- Press the DISPLAY button on the remote twice.
 - Current audio, subtitle and volume control will appear.
 - To make the screen disappear, press the DISPLAY button again.

Using the Display Function (CD/VCD)



- During playback, press the DISPLAY button on the remote.
 - Current track number, elapsed time and volume control will be displayed.
 - ◆ Use the ◀, ▶ button to select a track. Use the ▲, ▼ button or Number buttons to enter a different track number, then press the ENTER button.
 - ◆ To enter the time from which you want to start, use the ◀, ▶ button to select, then use the Number buttons to enter the time. Press the ENTER button.
 - To make the screen disappear, press the DISPLAY button again.

➤ **What is a Chapter?**
Each Title on a DVD can be divided into chapters (similar to tracks on an audio CD).

What is a Title?
A DVD may contain several different titles. For example, if a disc contains four different movies, each might be considered a title.

Repeat Play

Repeat the current track, chapter, title, a chosen section (A-B), or all of the disc (VCD/CD only).

When Playing a DVD :

- Playback, press the REPEAT button on the remote. Repeat screen appears.
- Select Chapter, Title or A-B using the ◀, ▶ button.
 - A-B Repeat
 - ◆ Press the REPEAT button. Select A-B on screen with the ◀, ▶ button. Or press the A-B button on the remote.
 - ◆ Press ENTER at the point where you want the repeat play to start (A). The B is automatically highlighted.
 - ◆ Press ENTER at the point where you want the repeat play to stop (B).
 - ◆ The A-B Repeat that you set plays until you turn Repeat off.
- Press ENTER.
- To return to normal playback press REPEAT again, then press the ◀, ▶ button to select Off and press ENTER.

-
- ◆ DVD repeats playback by chapter or title, CD and VCD repeat playback by disc or track.
 - ◆ Depending on the disc, the Repeat function may not work.
 - ◆ If the title or track is completed before marking the end (B), the end of title or track becomes B automatically.
 - ◆ When in VCD 2.0 mode (MENU ON mode), this function does not work.

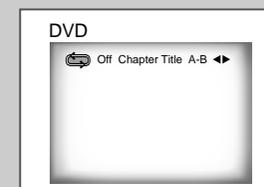

Program Play (DVD/VCD/CD)

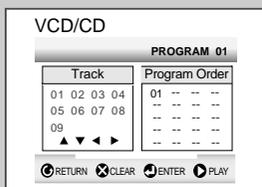
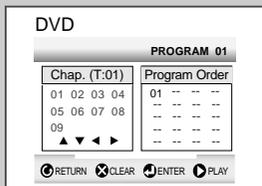

- 1 Press the MODE button.
- 2 Use the ◀, ▶ button to select PROGRAM. Press the ENTER button.
- 3 Use the ◀, ▶ button to select the first chapter (or track) to add to the program. Press the ENTER button. The selection numbers appear in the Program Order box.
- 4 Press the ▶|| (PLAY/PAUSE) button. The disc will be played back in programmed order.

Random Playback (DVD/VCD/CD)



- 1 Press the MODE button.
- 2 Use the ◀, ▶ button to select RANDOM. Press the ENTER button. The disc will be played back in random order.

-
- ◆ Depending on the disc, the Program and Random Playback function may not work.
 - ◆ When in VCD 2.0 mode (MENU ON mode), these functions do not work.
 - ◆ To resume normal playback, press the CLEAR button.

Using the Disc View Function (Track View VCD)

Displays the beginning view of each track and the track number.

- 1 During playback, press the TITLE button.
- 2 Press the ▲, ▼ button to select TRACK VIEW. Press the ENTER button.
- 3 Select the desired view by pressing the ▲, ▼ or ◀, ▶ buttons.
- 4 Press the ENTER button.

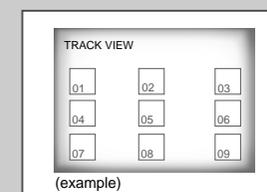

Using the Disc View Function (Index View VCD)

Displays the equally divided 9 views of the current playing track.

- 1 During playback, press the TITLE button.
- 2 Press the ▲, ▼ button to select INDEX VIEW. Press the ENTER button.
- 3 Select the desired view by pressing ▲, ▼ or ◀, ▶ buttons.
- 4 Press the ENTER button.

-
- ◆ In stop mode on VCD, press the TITLE button and the TRACK VIEW will be displayed.
 - ◆ **When pressing the TITLE button with a DVD;** the disc's TITLE MENU function comes up. A disc must have at least two titles for the TITLE MENU function to work.
 - ◆ **When pressing the TITLE button with a CD;** the unit enters the INTRO mode. INTRO lets you listen to the beginning of each track for about 10 seconds.

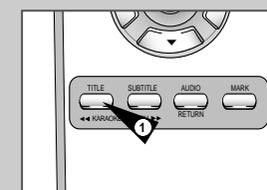
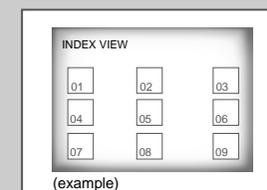

Selecting the Audio Language (Using the AUDIO button)

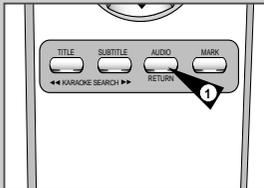

You can select a desired language quickly and easily with the **AUDIO button**.

- 1 Press the AUDIO button.
- 2 Use the ▲, ▼ button to select the desired language on a DVD.
 - The audio and subtitle languages are represented by abbreviations.
- 3 Use the ▲, ▼ button to select STEREO, R CHANNEL or L CHANNEL. (On VCD/CD)

Selecting the Subtitle Language (Using the SUBTITLE button)

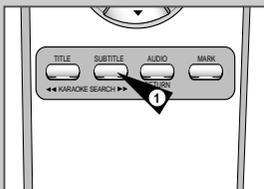

You can select a desired subtitle quickly and easily with the **SUBTITLE button**.

- 1 Press the SUBTITLE button.
- 2 Use the ▲, ▼ button to select the desired subtitle language.
- 3 Use the ◀, ▶ button to determine whether or not the subtitle will be displayed.
 - Initially, the subtitling will not appear on screen.
 - The audio and subtitle languages are represented by abbreviations.

-
- ◆ This function depends on what languages are encoded on the disc and may not work with all DVDs.
 - ◆ A DVD disc can contain up to 32 subtitle languages.

Changing the Camera Angle

When a DVD contains multiple angles of a particular scene, you can select the Angle function.

Using the **ANGLE button** :

Check to see if an 'ANGLE ([ANGLE])' mark is present at the upper right hand corner of the screen.

- 1 When an 'ANGLE' mark is shown, press the ANGLE button.
- 2 Use the ▲, ▼ button to select the desired screen angle. Then press the ENTER button.
- 3 To turn off the display, press the ANGLE button again.

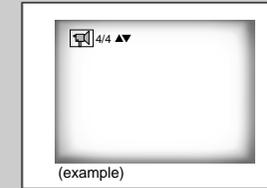

(example)

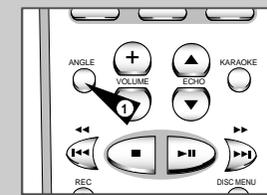

Using the Mark Function (DVD/VCD)



The Mark function lets you select parts of a DVD or VCD (MENU OFF mode) so that you can quickly find the section at a later time.

- 1 During playback, press the MARK button on the remote. A marker will be displayed.
- 2 Use the ◀, ▶ button to move to the desired bookmark icon.
- 3 When you reach the scene you want to mark, press the ENTER button. The icon will change to a number (1, 2, or 3).
- 4 Press the MARK button to turn off the display.

Recalling a Marked Scene



- 1 During playback, press the MARK button on the remote.
- 2 Use the ◀, ▶ button to select a marked scene.
- 3 Press the ▶II (PLAY/PAUSE) button to skip to the marked scene.

Clearing a Mark

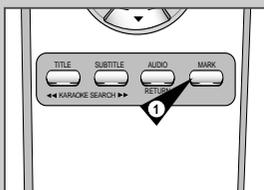

- 1 During playback, press the MARK button on the remote.
- 2 Use the ◀, ▶ button to select the bookmark number you want to delete.
- 3 Press the CLEAR button to delete a bookmark number. Press the MARK button to turn off display.

- ◆ Up to three scenes may be marked at the same time.
- ◆ When in VCD 2.0 mode (MENU ON mode), this function does not work.
- ◆ Depending on the disc, the Bookmark function may not work.

Using the Zoom (DVD/VCD)

- 1 During playback or pause mode, press the ZOOM button on the remote. A square will be displayed on screen.
- 2 Use the ▲, ▼ or ◀, ▶ button to select the part of the screen you want to zoom.
- 3 Press the ENTER button.
 - During DVD playback, press ENTER to zoom in 2X/4X/2X/normal in order.
 - During VCD playback, press ENTER to zoom in 2X/normal in order.

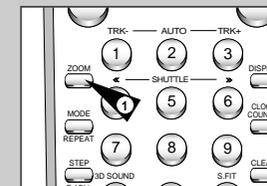

3D Sound Function

The simulated surround effect (SPATIALIZER N-2-2) depends on the disc contents. If you connect the unit to your stereo system, you can enhance sound quality and produce a greater surround effect.

This feature is useful when you are using the DVD player with a two channel stereo through the analog outputs.

(Discs which are recorded with LPCM or DTS will not work. When the DOLBY DIGITAL OUT or MPEG-2 DIGITAL OUT are set to BITSTREAM in the SETUP MENU, the 3D Sound function will not work.)

- 1 During playback, press the 3D SOUND (3D) button. The 3D SOUND mark will be displayed on screen. (Be sure the DOLBY DIGITAL OUT or MPEG-2 DIGITAL OUT are set to PCM.)
- 2 Press the ▲, ▼ button to turn the 3D Sound feature on or off.

- ◆ 3D Sound is possible only on discs recorded using DOLBY SURROUND or DOLBY DIGITAL. However, some of these discs do not contain rear channel sound signals.
- ◆ Depending on the disc, the Zoom and 3D Sound function may not work.

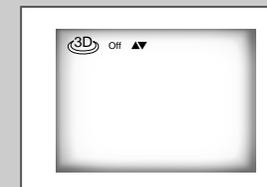

S.FIT PLAY



- 1 Press S.FIT button on remote control.
 - Allows you to eliminate the black bars in the top and bottom of the screen when a movie is playing in the Widescreen format (16:9).
 - Screen Fit will not work when the Zoom mode is active. (you can not remove the black bars on the screen) However, Zoom mode will work when Screen Fit is active.

-
- ◆ Various aspect ratios are available only in multiple screen format discs.
 - ◆ This function does not work when a DVD has been recorded in a multi-camera angle format.
 - ◆ On some DVDs, the black bars cannot be eliminated due to their aspect ratio.

Beginning Karaoke Functions



- 1 Connect the Mixed Audio Out terminals with the TV or AMP.
- 2 Press the power button.
- 3 Connect Mic into Mic 1 or Mic 2 jack. Then the karaoke mode is transferred to ON mode.
 - To disconnect the Mic makes the karaoke mode transfer to OFF mode automatically.

Key Control



- 1 Pressing the KARAOKE button makes the karaoke ON mode.
- 2 Select the "KEYCON" using the LEFT/RIGHT buttons.
- 3 By use of the LEFT/RIGHT buttons, change to the desired tone.
 - **b** : To let 7 scales down by half scale.
 - **s** : Original scale.
 - **#** : To let 7 scales up by half scale.

-
- ◆ Key control function is not applied to the Mic output.
 - ◆ Key control function can not work at the VCR

Reserving a Song

It is the function to reserve the desired song in advance by use of Karaoke function.

- 1 Playback the Karaoke Disc containing the wanted songs.
- 2 After pushing the KARAOKE button of the remote transfer to the KARAOKE ON mode using the UP/DOWN buttons.
- 3 Select the "REQUEST" using the LEFT/RIGHT buttons.
- 4 Input the number (Track No.) of the desired song into the flickering part(-).
 - You can reserve up to 10 songs.
- 5 When you want the next reserved song during playing a song, press the **▶▶** button.



Cancellation of reservation

- 1 Cancel by pressing the CLEAR button of the remote.
 - The last reserved song will be erased first.
- 2 Continuous pressing of the CLEAR button can cancel the next reserved song.
- 3 If the reservation is required again, input the song number in the flickering part.

-
- ◆ Request function is available only when the Karaoke mode is "ON".
 - ◆ When using "▶▶" button, it can not work at the last song.
 - ◆ When using Request function, the "DISPLAY" and "REPEAT" function does not work.

Vocal Fader

Pressing the **KARAOKE** button twice displays the following in Karaoke **ON** mode:

- The function to make the music only sound by cancelling vocal when playing a Karaoke disc.

	VOCAL FADER	Remark
↓	V1	CH1. Vocal Cancel
↓	V2	CH2. Vocal Cancel
↓	V1 +V2	CH1, CH2. Vocal Cancel
↓	OFF	Vocal Fader Off

- In VCD, CVD or CD, you can select only the ON or OFF.

VOCAL FADER : on ◀▶
GUIDE MELODY : off
SCORE : off

Guide Melody

- ◆ To guide melody through xylophone and piano help you sing easily.
- ◆ This function works only on the DVD Karaoke disc on which the guide melody is recorded.

Score Function

- Press **KARAOKE** button twice to turn the Score Mode On.
- ◆ Score will pop up whenever a song is completed.

Types of Karaoke disc

◆ DVD Karaoke Disc

Channel	Karaoke -Channel	5CH. DVD	2CH. DVD
1 CH	L	Left stereo music	Left stereo music + Vocal
2 CH	R	Right stereo music	Right stereo music + Vocal
3 CH	M	Guide melody	-
4 CH	V1	Vocal track	-
5 CH	V2	Vocal track	-

◆ CVD, VCD Karaoke Disc

Channel	Karaoke -Channel	CVD	VCD, CD
1 CH	CH1 LEFT	Left stereo music+Vocal	Left stereo music
1 CH	CH1 RIGHT	Right stereo music+Vocal	Right stereo music + Vocal
2 CH	CH2 LEFT	Left stereo music	-
2 CH	CH2 RIGHT	Right stereo music	-

CAUTIONS: Make sure to turn the KARAOKE MODE to OFF to play a movie disc or play in a general mode. If you play a movie disc with the KARAOKE ON, a score will show up every time when a chapter is over.

Using the Setup Menu

The Setup menu lets you customize your DVD player by allowing you to select various language preferences, set up a parental level, even adjust the player to the type of television screen you have.

- 1 With no disc playing, press the SETUP button on the remote.

PLAYER MENU ① Setup of the Display, Language (See page 42)
Use the Player preference menu to select the language for the player's on-screen displays.

DISC MENU ② Setup of the Menu Language (See page 42)
Use the Menu preference menu to select the language you want a DVD's disc menu to be displayed in.

AUDIO ③ Setup of the Audio Language (See page 43)
Use the Audio preference menu to select the soundtrack language.

SUBTITLE ④ Setup of the Subtitle Language (See page 43)
Use the Subtitle preference menu to select the language the disc's subtitles are to be displayed in.

PARENTAL ⑤ Setup of the Parental Level (See page 44)
Allows users to set the level necessary to prevent children from viewing unsuitable movies such as those with violence, adult subject matter, etc.

AUDIO OPTIONS ⑥ Setup of the Audio Options (See page 45)

DISPLAY OPTIONS ⑦ Setup of the Display Options (See page 46)
Use to select which type of screen you want to watch and several display options.

- 2 Use the ▲, ▼ button on the remote to access the different features.

- 3 Press the ENTER button to access the sub features.
To make the setup screen disappear after setting up, press the RETURN button again.

➤ Depending on the disc, some Setup Menu selections may not work.

SETUP MENU

1 Player Menu English
2 Disc Menu English
3 Audio English
4 Subtitle Automatic
5 Parental Unlocked
6 Audio Options
7 Display Options

RETURN ENTER

Setting Up the Language Features

e.g. Setting up in ENGLISH.



If you set the player menu, disc menu, audio and subtitle language in advance, it will come up automatically every time you watch a movie.

Using the Player Menu :

- 1 With no disc playing, press the SETUP button.
- 2 Use the ▲, ▼ button to select the PLAYER MENU.
- 3 Press the ENTER button.
- 4 Use the ▲, ▼ button to select 'ENGLISH'.
- 5 Press the ENTER button.
 - ENGLISH is selected and the screen returns to SETUP MENU.
 - To make the SETUP MENU disappear, press the RETURN button.

Using the Disc Menu Language

e.g. Setting up in ENGLISH.



This function changes the language only for the text on the disc menu screens.

- 1 With no disc playing, press the SETUP button.
- 2 Use the ▲, ▼ button to select DISC MENU.
- 3 Press the ENTER button.
- 4 Use the ▲, ▼ button to select 'ENGLISH'.
 - Select "OTHERS" if the language you want is not listed.
- 5 Press the ENTER button.
 - ENGLISH is selected and the screen returns to SETUP MENU.

Setting Up the AUDIO Language Features

Using the Audio Language :

- 1 With no disc playing, press the SETUP button.
- 2 Press the ▲, ▼ button to move to AUDIO.
- 3 Press the ENTER button.
- 4 Press the ▲, ▼ button to select 'ENGLISH'.
 - Select "ORIGINAL" if you want the default soundtrack language to be the original language the disc is recorded in.
 - Select "OTHERS" if the language you want is not listed.
- 5 Press the ENTER button.
 - ENGLISH is selected and the screen returns to SETUP MENU.



Using the Subtitle Language

- 1 With no disc playing, press the SETUP button.
- 2 Use the ▲, ▼ button to select SUBTITLE.
- 3 Press the ENTER button.
- 4 Use the ▲, ▼ button to select 'ENGLISH'.
 - Select "AUTOMATIC" if you want the subtitle language to be the same as the language selected as the audio preference.
 - Select "OTHERS" if the language you want is not listed. Some discs may not contain the language you select as your initial language; in that case the disc will use its original language setting.
- 5 Press the ENTER button.
 - ENGLISH is selected and the screen returns to SETUP MENU.

-
- ◆ If the selected language is not recorded on the disc, the original pre-recorded language is selected.
 - ◆ **How to make the SETUP MENU disappear or return to menu screen during set up;** Press RETURN button.



Setting Up the Parental Control

The Parental Control function works in conjunction with DVDs that have been assigned a rating - which helps you control the types of DVDs that your family watches. There are up to 8 rating levels on a disc.

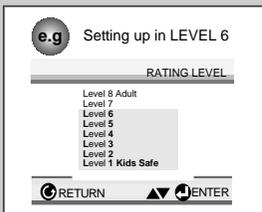
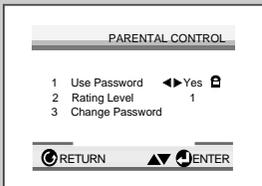
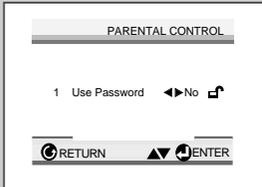

- 1 With no disc playing, press SETUP. The Setup Menu screen appears.
- 2 Use ▲, ▼ to select Parental. Press ENTER. The Parental Control screen appears.
- 3 Use ◀, ▶ to select Yes if you want to use a password. Press ENTER. The Enter Password screen appears.
- 4 Enter your password. The Re-enter Password screen appears to confirm the password. Enter your password again. The Parental Control screen appears.
- 5 About the Rating Level ;
The Rating Level will work only when Use Password is set to Yes. To unlock the player, use ◀, ▶ to select No. Use ▲, ▼ to select Rating level. Press ENTER.
- Use ▲, ▼ to select the level(e.g. Level 6) and press ENTER. The disc that contains Level 7 will now not play.
- To cancel the rating level, use ◀, ▶ to select No in Use Password.
- 6 About the Change Password ;
- Use ▲, ▼ to select Change Password. The Change Password screen appears.
- Enter your new password. Re-enter the new password again.

- ◆ **How to make the SETUP MENU disappear or return to menu screen during set up;** Press RETURN button.
- ◆ If you have forgotten your password, see Forgot Password in the Troubleshooting Guide.

Setting Up the Audio Options

- 1 With no disc playing, press the SETUP button.
- 2 Use the ▲, ▼ button to select AUDIO OPTIONS. Then press the ENTER button.
- 3 Use the ▲, ▼ button to select the desired item. Then press the ◀, ▶ button.

- ① DOLBY DIGITAL OUT / ② MPEG-2 DIGITAL OUT
 ① PCM : Converts to PCM(2CH) 48kHz/16Bit audio. Select PCM when using the Analog Audio Outputs.
 ② BITSTREAM : Converts to Dolby Digital BITSTREAM - 5.1CH (in case of MPEG-2, 7.1CH). Select BITSTREAM when using the Digital Audio Output.

NOTE : Be sure to select the correct Digital Output or no audio will be heard.

- ③ DTS
 ① ON : Outputs DTS BITSTREAM via digital output only. Select DTS when connecting to a DTS DECODER.
 ② OFF : Doesn't output digital signal.
- ④ DYNAMIC COMPRESSION
 ① ON : To select dynamic compression.
 ② OFF : To select the standard range.
- ⑤ 2X SCAN AUDIO
 ① ON : Turns 2X audio on.
 ② OFF : Turns 2X audio off.
 Though 2X SCAN AUDIO is ON in the SETUP MENU, no sound will be heard on discs which are recorded with LPCM, DTS or MPEG-2.

- ◆ **How to make the SETUP MENU disappear or return to menu screen during set up;** Press RETURN button.
- ◆ Certain audio features of this product manufactured under a license from Desper Products, Inc. Spatializer® and circle-in-square device are trademarks owned by Desper Products, Inc.
- ◆ Manufactured under license from Dolby Laboratories. "Dolby" and the double-D symbol are trademarks of Dolby Laboratories. Confidential unpublished works. ©1992-1997 Dolby Laboratories Inc. All rights reserved.
- ◆ "DTS" and "DTS Digital Out" are trademarks of Digital Theater Systems, Inc.

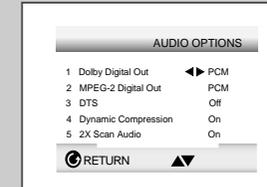

Setting Up the Display Options

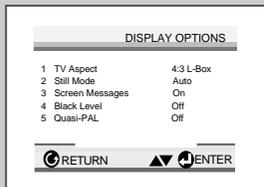

- 1 With no disc playing, press the SETUP button.
- 2 Use the ▲, ▼ button to select DISPLAY OPTIONS. Then press the ENTER button.
- 3 Use the ▲, ▼ button to select the desired item. Then press the ◀, ▶ button.

1 TV ASPECT

- 1 4:3 LETTER BOX : Select when you want to see the total 16:9 ratio screen DVD supplies, even though you have a TV with a 4:3 ratio screen. Black bars will appear at the top and bottom of the screen.
- 2 4:3 PAN-SCAN : Select this for conventional size TVs when you want to see the central portion of the 16:9 screen. (Extreme left and right side of movie picture will be cut off.)
- 3 16:9 WIDE : You can view the full 16:9 picture on your widescreen TV.

2 STILL MODE

- 1 FIELD : Select this feature when the screen shakes in the AUTO mode.
- 2 FRAME : Select this feature when you want to see small letters more clearly in the AUTO mode.
- 3 AUTO : When selecting AUTO, FIELD/FRAME mode will be automatically converted.

3 SCREEN MESSAGES

Use to turn on-screen messages on or off.

4 BLACK LEVEL

Adjusts the brightness of the screen.

5 QUASI-PAL

Depending on a disc, you can play a NTSC DVD disc by Quasi-PAL mode.



- ◆ **How to make the SETUP MENU disappear or return to menu screen during set up:** Press RETURN button.

Technical Specifications

General	Rated voltage	AC100 - 240V, 50/60Hz
	Power consumption	21Watts
	Weight	5.6Kg
	Size	430mm X 357mm X 100mm
	Operating ambient temperature	+5°C ~ +35°C
	Installation conditions	Operation position : Horizontal, Relative humidity : Below 75%
Input	Video input (Rear)	RCA jack : 1.0Vp-p (unbalanced) 75Ω
	Audio input (Rear)	RCA jack : -8dBm, 47Kohm unbalanced
Output	Audio (DVD, VCR)	2 Stereo Audio outputs, -8dBm, 1.5KΩ
	Audio (DVD only)	Digital audio out (OPTICAL)
	Video (DVD, VCR)	1 Composite video out, 75Ω, 1Vpp
	Video (DVD only)	1 Component video output, 75Ω Y=1.0Vpp, Pb=0.7Vpp, Pr=0.7Vpp
VCR	Tape format	VHS type video tape,
	Color system	PAL/MESECAM/NT3.58/NT4.43/NTSC PB on PAL TV
	Video S/N	Above 43dB (standard recording)
	Resolution	Above 240 lines (standard recording)
	Audio S/N	Above 68dB (Hi-Fi), 39dB (Mono)
	Audio frequency characteristics	20Hz - 20KHz (Hi-Fi)
DVD	Disc	DVD, CD (12cm), CD (8cm), VIDEO-CD (12cm)
	Audio S/N	110dB
	Audio dynamic range	96dB

Problems and Solutions (VCR)

Before contacting the Samsung after-sales service, perform the following simple checks.

Problem	Explanation/Solution
No power	<ul style="list-style-type: none"> ◆ Check that the power plug is connected to a wall outlet. ◆ Have you pressed the STANDBY/ON button?
You cannot insert a video cassette	<ul style="list-style-type: none"> ◆ A video cassette can only be inserted with the window side up and the safety tab facing you.
No playback picture or the picture is distorted	<ul style="list-style-type: none"> ◆ Check to see if you are using a prerecorded tape.
Noise bars or streaks on playback	<ul style="list-style-type: none"> ◆ Press the TRK (+ or -) buttons to minimize this effect.
When the ► button is pressed during playback, the still picture has severe "noise bars" streaks	<ul style="list-style-type: none"> ◆ A still picture may have "noise bars", depending on the condition of the tape. Press the TRK (+ or -) buttons during SLOW motion to minimize this effect.
Video Head Cleaning	<ul style="list-style-type: none"> ◆ If poor pictures appear on a variety of cassettes, the video heads may need cleaning. This is not a common problem and unless it appears, the heads should not be cleaned. When cleaning the video heads, read all instructions provided with the head cleaning cassette. Incorrect head cleaning can permanently damage the video heads.

If you are unable to solve the problem after reading the above instructions, note:

- ◆ The model and serial number on the rear of your DVD-VCR
- ◆ The warranty information
- ◆ A clear description of the problem

Then contact your nearest SAMSUNG after-sales service.

Troubleshooting Guide (DVD)

Before requesting service (troubleshooting)

Problem	Action	Page
Disc does not play.	<ul style="list-style-type: none"> ◆ Ensure that the disc is installed with the label side facing up. ◆ Check the region number of the DVD. ◆ This player cannot play CD-ROMs, DVD-ROMs, etc. Insert a DVD, a VIDEO-CD or a CD. 	P26
The ⌀ icon appears on screen.	<ul style="list-style-type: none"> ◆ The features or action cannot be completed at this time because: <ol style="list-style-type: none"> 1. The DVD's software restricts it. 2. The DVD's software doesn't support the feature (e.g., angles). 3. The feature is not available at the moment. 4. You've requested a title or chapter number or search time that is out of range. 	P29-32 P34-37
Playback mode differs from the Setup Menu selection.	<ul style="list-style-type: none"> ◆ Some of the functions selected in the Setup Menu may not work properly if the disc is not encoded with the corresponding function. 	P46-47
The screen ratio cannot be changed.	<ul style="list-style-type: none"> ◆ The Screen Ratio is fixed on your DVDs. 	P46
No audio.	<ul style="list-style-type: none"> ◆ Make sure you have selected the correct Digital Output in the Audio Options Menu. 	P45
Forgot password	<ul style="list-style-type: none"> ◆ Press power on from a cold start with no disc in the unit. Press the ►► and ► buttons simultaneously on the front panel for five seconds. Press the SETUP button on the remote control to select the Parental Mode. The Parental Mode is now unlocked as indicated on the display. Press the DOWN button to select Parental. Press ENTER and the Create Password display will appear. You can now set your rating level and change your password to a new number. 	P44
If you experience other problems.	<ul style="list-style-type: none"> ◆ Go to the contents and find the section of the instruction book that contains the explanations regarding the current problem, and follow the procedure once again. ◆ If the problem still cannot be solved, please contact your nearest authorized service center. 	

THIS APPLIANCE IS DISTRIBUTED BY

