

BRANDWEEK
CUSTOMER LOYALTY
AWARD 2004

powered by



Brand Keys

Samsung Mobile Phones have been rated number one in brand loyalty three years in a row by consumers in the Brand Keys Customer Loyalty Index, now produced in partnership with Brandweek. Brand Keys, Inc. is a leading independent authority on brand loyalty.

SAMSUNG

SGH

c207

User Guide



SAMSUNG DIGITall
everyone's invited.™

Samsung Telecommunications America
1301 East Lookout Drive
Richardson, Texas 75082
1-800-SAMSUNG
www.samsungwireless.com

© 2004 Samsung Telecommunications America. Samsung is a registered trademark of Samsung Electronics America, Inc. and its related entities. Specifications subject to change without notice.

GH68-05840A
10/2004. Rev.1.0

SGH-c207

Portable Digital Telephone

User Manual

Please read this manual before operating your phone,
and keep it for future reference.



Intellectual Property

All Intellectual Property, as defined below, owned by or which is otherwise the property of Samsung or its respective suppliers relating to the SAMSUNG Phone, including but not limited to, accessories, parts, or software relating thereto (the "Phone System"), is proprietary to Samsung and protected under federal laws, state laws, and international treaty provisions. Intellectual Property includes, but is not limited to, inventions (patentable or unpatentable), patents, trade secrets, copyrights, software, computer programs, and related documentation and other works of authorship. You may not infringe or otherwise violate the rights secured by the Intellectual Property. Moreover, you agree that you will not (and will not attempt to) modify, prepare derivative works of, reverse engineer, decompile, disassemble, or otherwise attempt to create source code from the software. No title to or ownership in the Intellectual Property is transferred to you. All applicable rights of the Intellectual Property shall remain with SAMSUNG and its suppliers.

Samsung Telecommunications America, L.P.

U.S. Headquarters:

1301 East Lookout Drive
Richardson, TX 75082
Tel: 972-761-7000
Fax: 972-761-7001

Customer Care Center:

1601 E. Plano Parkway
Suite 150
Plano, TX 75047
Tel: 888-987-HELP (4357)
Fax: 972-761-7501

Internet Address: <http://www.samsungusa.com/wireless>

©2004 Samsung Telecommunications America. All rights reserved. No reproduction in whole or in part allowed without prior written approval. Samsung is a registered trademark of Samsung Electronics America, Inc. and its related entities.

Table of Contents

Unpacking	11
Your Phone	13
Phone Layout	13
Display	16
Getting Started	21
Installing the SIM Card	21
Charging a Battery	23
Switching the Phone On/Off	25
Call Functions	27
Making a Call	27
Adjusting the Volume	29
Answering a Call	30
Viewing Missed Calls	31
Quickly Switching to Silent Mode	32
Selecting Functions and Options	35
Locking or Unlocking the Keypad	37
Phone Book	39
Storing a Number with a Name	39
Using Phone Book Entry Options	41
Dialling a number from Phone Book	42
Searching for a Number in Phone Book	43
Editing a Caller Group	45
Deleting all of the Phone Book entries	46
Speed-dialing	47
Checking the Memory Status	48
Using the service Dialing Numbers	49
Entering Text	51
Changing the Text Input Mode	52
Using T9 Mode	53
Using the Upper/Lower-Case Character Mode	55

Using Number Mode	56
Using Symbol Mode	57
Options During a Call	59
Putting a Call on Hold	59
Using the Menu Functions	60
Switching the Microphone Off (Mute)	60
Muting/Sending Key Tones	61
Sending Tones	61
Searching for a Number in Phone Book	62
Call Waiting	62
Making a Multi-party Call	63
Using the Menus	67
Accessing a Menu Function by Scrolling	67
Accessing a Menu Function by Using Its Shortcut	68
List of Menu Functions	68
Recent Calls	75
Missed Calls	75
Calls Received	75
Calls Made	75
Voice Mail	76
Delete All	77
Call Time	77
Messaging	79
Text Messages	79
Multimedia Messages	89
Instant Messaging (IM)	102
Push Message	108
Network Services	109
Call Forwarding	109
Call Barring	110
Call Waiting	112
Network Selection	113
Caller ID	113
Closed User Group (CUG)	114

Games	117
Downloading a new game	117
Launching a MIDlet	117
Using the game options	118
MEdia Mall	121
Shop Ringtones	121
Shop Games	121
Shop Graphics	122
Shop Multimedia	122
Shop Applications	122
MEdia Home	123
Sound Settings	125
Ring Tone	125
Ring Volume	125
Shop Ringtones	125
Alert Type	126
Keypad Tone	126
Message Tone	126
Alert on Call	127
Power On/Off	127
Extra Tones	128
Applications	129
Alarm	129
Calendar	130
Time & Date	133
Calculator	134
To Do List	134
Voice Memo	140
Currency Exchange	142
My MEdia	143
MEdia Net	143
Audio	149
Graphics	149
Delete All	150
Memory Status	151

Phone Settings	153
Display Settings	153
Greeting Message	155
Own Number	155
Language	156
Security	156
Extra Settings	159
Short Cut	160
Reset Settings	161
TTY Settings	161
Solving Problems	163
Access Codes	167
Phone Password	167
PIN	168
PUK	168
PIN2	169
PUK2	169
Health and Safety Information	171
Exposure to Radio Frequency (RF) Signals	171
For Body Operation	173
Precautions When Using Batteries	174
Road Safety	175
Operating Environment	177
Electronic Devices	177
Potentially Explosive Environments	179
Emergency Calls	179
Other Important Safety Information	180
Care and Maintenance	181
Acknowledging Special Precautions and the FCC and Industry Canada Notice	182
Appendix A: CERTIFICATION INFORMATION (SAR)	185
Appendix B: Guide to Safe and Responsible Wireless Phone Use	187
Appendix C: Consumer Update on Wireless Phones	193

Glossary	209
Index	213

Unpacking

Your package contains the following items:

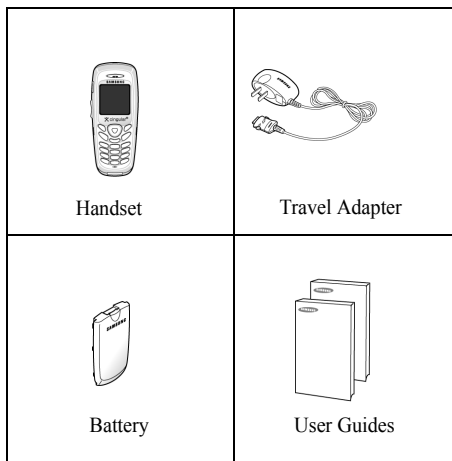

Your local Samsung dealer can provide you with additional accessories including:

- ◆ Simple hands-free kit
- ◆ Standard battery
- ◆ Holster
- ◆ Ear microphone
- ◆ Leather Case
- ◆ Cigarette lighter adapter
- ◆ Finger strap
- ◆ Data kit





Your Phone

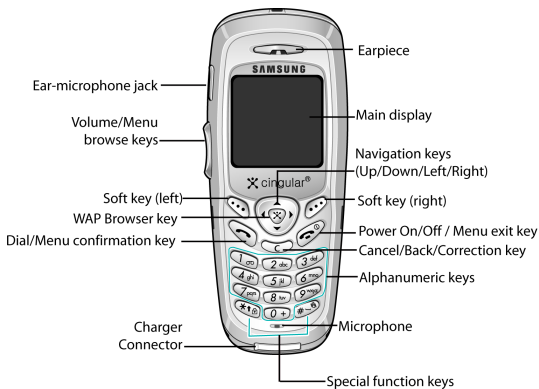



Phone Layout

The following illustrations show the main elements of your phone:



Key(s)	Description
	<p>In Menu mode, scroll through the menus.</p> <p>In Idle mode, allows you to access your favorite menus directly. For more information about shortcuts, see “Short Cut” on page 160.</p>

Key(s)	Description (Continued)
	<p>In Menu mode, the Left key returns to the previous menu level and the Right key selects the next menu.</p> <p>In Idle mode, allows you to access your favorite menus directly. For more information about shortcuts, see “Short Cut” on page 160.</p>
 (soft keys)	<p>Perform the functions indicated by the text above them, on the bottom line of the display.</p>
	<p>In Idle mode, launches the WAP (Wireless Application Protocol) browser.</p>
	<p>Makes or answers a call.</p> <p>When held down in Idle mode, recalls the last number dialed or received.</p> <p>In Menu mode, selects a menu function or stores information that you have entered, such as a name in the phone or SIM memory.</p>
	<p>Deletes characters from the display.</p> <p>In Menu mode, returns to the previous menu level.</p>

Key(s)	Description (Continued)
	<p>Ends a call. Also switches the phone on and off when held down.</p> <p>In Menu mode, cancels your input and returns to Idle mode.</p>
	<p>When held down in Idle mode, accesses your voice mail.</p>
	<p>Enter numbers, letters and some special characters.</p>
	<p>Used for various purposes in different functions.</p> <p>When held down while entering a phone number, the * key enters a pause.</p> <p>When held down in Idle Mode, the # key enters or exits the Silent mode and * key enters the key lock mode.</p>

Key(s)	Description (Continued)
	<p>(on the side of the phone) During a call, adjusts the earpiece volume.</p> <p>In Idle mode, adjusts the keypad tone volume.</p> <p>In Menu mode, scrolls through the menus and Phone Book.</p>

Display





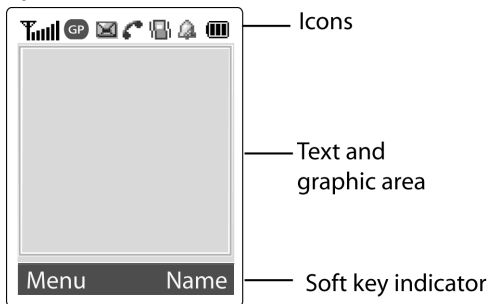



Display Layout







The display has three areas:



Area	Description
First line	Displays various icons. See page 18.
Middle lines	Displays messages, instructions, and any information that you enter, such as the number you are dialing.
Last line	Shows the functions currently assigned to the two soft keys.

Icons

Icon	Description
	Shows the received signal strength. The greater the number of bars, the better the signal.
	If this icon is gray, you are outside your network area and are restricted to emergency calls only.
	Appears when the GPRS service is available.
	Appears when you are connected to the GPRS network.
	Appears when a call is in progress.
	Appears when you set an alarm to ring at a specified time.
	Appears when a new text message is received.
	Appears when a new multimedia message is received.

Icon	Description
	Appears when Mute mode is active.
	Appears when Silent mode is active or you set the Alert Type menu (Menu 6.4), so that the phone vibrates when you receive a call. For further details, see page 32 and page 126 respectively.
	Shows the level of your battery. The more bars you see, the more power you have left.
	Appears when you have new or unchecked voice messages.
	Appears when the call diverting feature is activated.
	Appears when you are in your home zone. (Only if your service provider supports this.)
	Appears when your are in your office zone. (Only if your service provider supports this.)

Backlight

A backlight illuminates the display and the keypad. When you press any key the backlight turns on. It turns off when no keys are pressed within a given period of time, depending on your setting in the **Back Light** menu (**Menu 9.1.6**). After one minute, the display turns off to conserve your battery power.

To specify the length of time the backlight is active, set the Back Light menu (**Menu 9.1.6**). See “Back Light” on page 154 for further details.

Getting Started

Installing the SIM Card

When you subscribe to a cellular network, you are provided with a plug-in SIM card loaded with your subscription details, such as your PIN, any optional services available and many others.

Important! The plug-in SIM card and its contacts can be easily damaged by scratches or bending, so be careful when handling, inserting or removing the card.

Keep all SIM cards out of the reach of small children.

1. If necessary, switch off the phone by holding down the  key until the power-off image displays.
2. Remove the battery. To do so:

Press and hold down the catch above the battery on the back of the phone.

3. Slide the battery away, as shown.

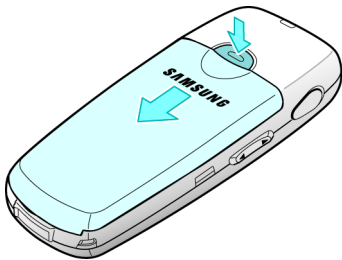

- Slide the SIM card into the SIM card socket so that it locks the card into place. Make sure the gold contacts of the card face into the phone.

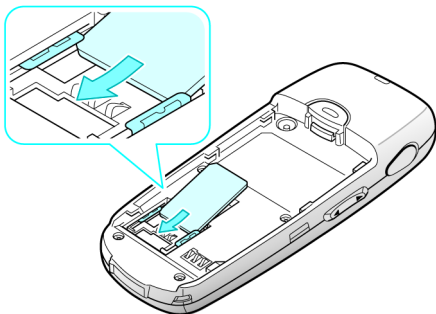

Note: When you need to remove the SIM card, slide it, as shown, and take it out of the socket.

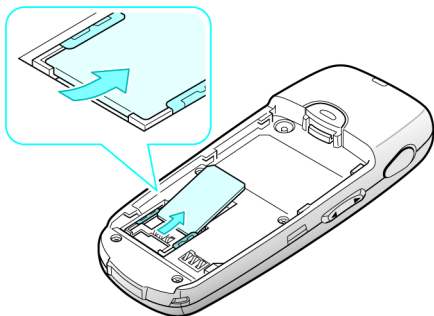

5. Place the battery so that the tabs on the end align with the slots at the bottom of the phone.

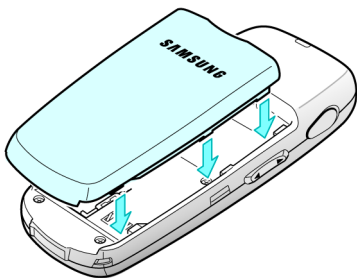

6. Press the battery until it clicks into place. Make sure that the battery is properly installed before switching the phone on.

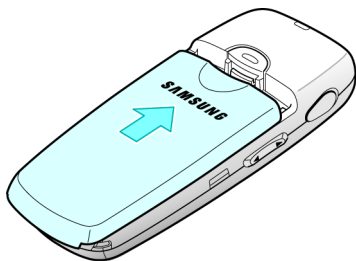

Charging a Battery

Your phone is powered by a rechargeable Li-ion battery. A travel adapter comes with your phone for charging the battery. Use only approved batteries and chargers. Ask your local Samsung dealer for further details.

You can use the phone while the battery is charging, but this causes the phone to charge more slowly.

Note: You must fully charge the battery before using your phone for the first time. A discharged battery is fully recharged in approximately 200 minutes.

1. With the battery in position on the phone, plug the connector of the travel adapter into the jack at the bottom of the phone.



2. Plug the adapter into a standard AC wall outlet.

While charging, the battery icon at the top right corner of the display repeatedly fills to show that the battery is charging.

3. When charging is finished, the battery icon becomes solid and the “Fully charged” message is displayed, unplug the adapter from the power outlet and from the

phone by pressing the gray tabs on both sides of the connector and pulling the connector out.

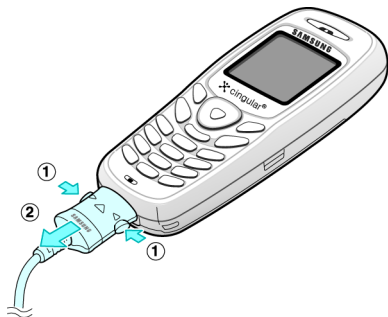

Note: You must unplug the adapter before you remove the battery from the phone during charging; otherwise, the phone could be damaged.

Low Battery Indicator

When the battery is weak and only a few minutes of talk time remain, the battery sensor informs you in the following ways: an empty battery icon flashes (), you hear a warning tone, and a message repeats at regular intervals on the display.

When the battery becomes too weak for the phone to operate, it switches off automatically.

Switching the Phone On/Off

1. Press and hold the  key until the phone switches on.
2. If the phone asks you to enter the phone password, enter the password and press the **OK** soft key. The

phone password is factory set to “00000000.” For further details, see “Change Password” on page 157.

3. If the phone asks for a PIN, enter the PIN and press the **OK** soft key or **X** key. For further details, see “Change PIN” on page 157.

The phone searches for your network and after finding it, the idle screen displays. Now, you can make or receive a call.

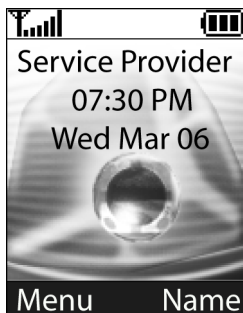

Note: The display language is preset to English at the factory. To change the language, use the **Language** menu (**Menu 9.4**). For further details, see “Language” on page 156.

4. When you wish to switch the phone off, press and hold the  key until the power-off image displays.



Call Functions

Making a Call



When the idle screen displays, enter the area code and phone number, and press the  key.

Note: When you activate the **Auto Redial** option in the **Extra Settings** menu (**Menu 9.6**), the phone automatically redials up to ten times when the person does not answer the call or is already on the phone.

Making an International Call

1. Press and hold the  key.
The + character appears.
2. Enter the country code, area code, and phone number and press the  key.

Correcting the Number

To clear	Press the
the last digit displayed	 key
any other digit in the number	Left or Right key until the cursor is immediately to the right of the digit to be cleared. Press the  key. You can also insert a missing digit simply by pressing the appropriate key.
the whole display	 key and hold it for more than one second.



Ending a Call

When you want to finish your call, briefly press the  key.





Redialing the Last Number

The phone stores the numbers you dialed, received or missed if the caller is identified. See “Recent Calls” on page 75 for further details.

To recall any of these numbers:

1. If you have typed characters on the display, press the  key to return to Idle mode.
2. Press the  key to display a list of the last numbers in the order you made or received.

- Use the Up and Down keys or volume keys to scroll through the numbers until the number you want highlights.

To	Press the
dial the number	 key.
edit the number	Options soft key or  key and select Edit . Then change the number, referring to “Correcting the Number” on page 28.
delete the number	Options soft key or  key and select Delete .
delete all of the numbers	Options soft key or  key and select Delete All .

Making a Call from Phone Book

You can store frequently used phone numbers in the SIM card or the phone’s memory, which are collectively called Phone Book. Simply select a name to recall the associated number. For further details about the Phone Book features, see page 39.

Adjusting the Volume

During a call, if you want to adjust the earpiece volume, use the Volume keys on the left side of the phone.

Press the ▲ key to increase the volume level and the ▼ key to decrease the level.

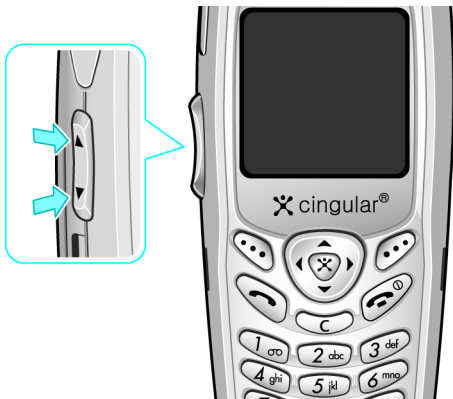

In Idle mode, you can also adjust the keypad tone volume using these keys.

Answering a Call

When somebody calls you, the phone rings and displays the incoming call animation.

When the caller can be identified, the caller's phone number, or name if stored in your Phone Book, displays.

1. Press the  key or the **Accept** soft key to answer the incoming call.

If the **Anykey Answer** option in the **Extra Settings** menu (**Menu 9.6**) is activated, you can press any key to answer a call except for the  key and the **Reject** soft key.

Note: To reject an incoming call, press and hold the Volume keys on the left side of the phone or press the **Reject** soft key or  key.

2. End the call by pressing the  key.

Note: You can answer a call while using the Phone Book or Menu features.

Viewing Missed Calls



When you are unable to answer a call for any reason, you can find out who is calling you, if this service is available, so that you can call the person back.

The number of calls you missed displays on the idle screen immediately after a call is missed.

To view the missed call immediately:

1. Press the **View** soft key.

The number corresponding to the most recent missed call displays, if available.

To	Press the
scroll through the missed calls	Up or Down key.
call the number displayed	 key.
edit or delete a missed call number	Select soft key or  key. See below.



Editing a Missed Call Number

Note: When the number corresponding to the missed call is not available, the **Edit** option does not display.



1. Press the **Options** soft key or  key.

2. Press the Up or Down key to highlight the **Edit** option.

3. Press the **Select** soft key or  key.
4. Change the number.

To	Press the
call the number	 key.
store the number	Save soft key or  key and enter the name and location. For further details, see page 39.

Deleting a Missed Call

1. Press the **Options** soft key or  key.
2. If necessary, press the Up or Down key to highlight the **Delete** option.
3. Press the **Select** soft key or  key.

You can press the [®] key at any time to exit the Missed Call feature.

Note: You can access the Missed Call feature at any time by selecting the **Missed Calls** menu (**Menu 1.1**).

Quickly Switching to Silent Mode

Silent mode is convenient when you wish to stop the phone from making noise, in a theater for example. In Idle mode, press and hold the **#** key until the “Silent Mode” message and the Vibration icon () display.



When you enter Silent mode, your phone changes the sound settings as follows:

Option	New Setting
Alert Type (Menu 6.4)	Vibration
Keypad Tone (Menu 6.5)	Off
Message Tone (Menu 6.6)	Vibration
Alert on Call (Menu 6.7)	On
Power On/Off (Menu 6.8)	Vibration
Extra Tones (Menu 6.9)	Off

To exit and reactivate the previous sound settings, press and hold the # key again until “Exit Silent Mode” appears. The Vibration icon () no longer displays.

Note: Menu 6.8 Power On/Off vibration occurs during power on NOT power off.







Selecting Functions and Options

Your phone offers a set of functions that allow you to customize your phone. These functions are arranged in menus and sub-menus, accessed using the two soft keys marked  and . Each menu and sub-menu allows you to view and alter the settings of a particular function. The roles of the soft keys vary according to the function you are currently using; the label on the bottom line of the display just above each key indicates its current role.



To view the various functions and options available and to select the one you want:

1. Press the appropriate soft key.

To	Press the
select the: <ul style="list-style-type: none">• function displayed• option highlighted	Select soft key or the  key.
view the next function or highlight the next option on a list	Down key or  key on the left side of the phone.
move back to the previous function or option on a list	Up key or  key on the left side of the phone.
move back up one level in the structure	Left key,  soft key or  key.
exit the structure without changing the settings	 key.

In some functions, you may be asked for a password or PIN. Enter the code and press the **OK** soft key or  key.

Note: When you access a list of options, your phone highlights the current option. If, however, there are only two options, such as **On/Off** or **Enable/Disable**, your phone highlights the option that is not currently active so that you can select it directly.

Locking or Unlocking the Keypad

You can lock the keypad to avoid pressing keys by mistake.

To lock the keypad manually, press and hold the * key in Idle mode until the “Key Pad Locked” message displays.

To lock the keypad automatically, use the **Auto Key Lock** option (**Menu 9.1.4**).

In the key lock mode, you can dial emergency calls and answer incoming call using keypad.

When you end the call, your phone returns to the key lock mode after a given period time.

To exit the key lock mode, press the **Unlock** soft key and then press the * key.

The “Keypad Active” message displays.

Phone Book

You can store phone numbers and their corresponding names in your SIM card and phone's memories. They are physically separate but are used as a single entity, called Phone Book.

Storing a Number with a Name

There are two ways to store a number:

- Using the **Save** soft key or  key in Idle mode
- Using the **New Entry** option in the **Phone Book** menu

Storing a Number in Idle Mode



When you enter a number, **Save** appears above the left soft key to allow you to store the number in Phone Book.

1. Enter the number you want to store.

Note: If you make a mistake while entering a number, correct it using the  key.

2. To save the number, press the **Save** soft key or  key.

3. Select an icon to identify the category of the number to be stored. Three categories are available:

-  : Mobile phone number
-  : Office number
-  : Home number

To select the category, press the Left or Right key and press the **Select** soft key or  key.

- Choose either **SIM Memory** or **Phone Memory** to store the number.
- Enter a name and press the **OK** soft key or **⌘** key.

The maximum length you can enter for a name depends on your SIM card.

Note: When you change phones, any numbers stored in your SIM card memory are automatically available with the new phone, whereas any numbers stored in the phone's memory must be reentered.





- Press the **OK** soft key to store the name and number. The new Phone Book entry displays.

To	Press the
use the entry options	Options soft key. For further details, see page 41.
return to the idle screen	 key.

Storing a Number Using the Phone Book Menu

- At the idle screen, press the **Name** soft key.
- Scroll to **New Entry** by pressing the Up or Down key and press the **Select** soft key.
- Select an icon to identify the category of the number to be stored by pressing the Left or Right key, and press the **Select** soft key or **⌘** key.

Note: The E-mail icon () is available in this step. It allows you to save an E-mail address instead of a phone number.

4. Choose either **SIM Memory** or **Phone Memory** to store the number. Press the **Select** soft key or  key.
5. Enter a name and press the **OK** soft key or  key.
The maximum length of a name depends on your SIM card.
6. Enter a number or address you want to store and press the **Save** soft key or  key.
7. Press the **OK** soft key or  key.



Using Phone Book Entry Options

While accessing any Phone Book entry, press the **Options** soft key to use the options for the entry.

To	Press the
select the highlighted option	Select soft key or the  key.
highlight a different option	Up or Down key until the option you want highlights.

The following options are available:

Paste: allows you to paste the number into the normal dialing mode. Use this option to dial a number similar to one in Phone Book, such as a different extension in the same office.

Use the  key to change the number as required; see page 28 for further details. When you are ready to dial, press the  key.

Edit: allows you to edit the name and/or number.

Delete: allows you to erase the name and number from Phone Book. You are asked to confirm that you wish to erase the name and number by pressing the **Yes** soft key.

Copy: allows you to copy the number to another location. You can select the memory and the location number.

Caller Group: allows you to organize your Phone Book entry in caller groups so that the phone alerts you in a specific way when a person from one of your groups calls you. Select one of the ten groups available.

To remove an entry from a group, select the **No Group** option.

For more information about how to change caller group properties, see page 45.

Add Entry: allows you to add a new number to the currently selected name.

Dialling a number from Phone Book

Once you have stored phone numbers in Phone Book, you can dial them easily and quickly by using the location numbers that were assigned to them in Phone Book.



Note: If you cannot remember a location number, you need to go into the **Search** menu in the **Phone Book** menu to search for the entry by name. For details, see page 43.

Dialling a number from the SIM card



1. In Idle mode, enter the location number for the phone number you want to dial and press the **#** key.

The list of entries in the SIM card appears.

2. You can press the Up or Down key to find other numbers on the list.

3. Press the **Dial** soft key,  key, or  key when you have selected the number you want.

Dialing a number from the phone's memory

1. In Idle mode, press and hold the **0** key. A **+** appears.
2. Enter the location number of the phone number you want and press the **#** key.
3. The list of entries in the phone's memory appears.
4. You can press the Up or Down key to find other numbers on the list.
5. Press the **Dial** soft key,  key, or  key when you have selected the number you want.

Searching for a Number in Phone Book



After storing numbers in Phone Book, you can search for them in two ways; by name and by caller group.

Searching for a Number by Name

1. At the idle screen, press the **Name** soft key.
2. Press the **Select** soft key or  key when **Search** highlights. You are asked to enter a name.
3. Enter the first few letters of the name.

The Phone Book entries are listed, starting with the first entry matching your input.

To	Press the
view the highlighted entry	View soft key.
select a different entry	Up or Down key until the entry you want highlights.
look for a name starting with a different letter	key labeled with the letter you want.

- Once you have found the entry, press the  key to dial the number, or press the **Options** soft key or  key to access the Phone Book entry options; for further details, see page 41.

Searching for a Number by Caller Group



- When the idle screen displays, press the **Name** soft key.
- Scroll to **Group Search** by pressing the Up or Down key and press the **Select** soft key. You are asked to enter a group name.
- Enter the first few letters of the group name that you wish to find.

The caller groups are listed, starting with the first group matching your input.



4. Scroll to the group you want by pressing the Up or Down key and press the **View** soft key or  key.

The Phone Book entries in the caller group are listed.

To	Press the
view the highlighted entry	View soft key or  key.
select a different entry	Up or Down key until the entry you want highlights.

5. Once you have found the entry, press the  key to dial the number, or press the **Options** soft key or  key to access the Phone Book entry options; for further details, see page 41.

Editing a Caller Group



1. When the idle screen displays, press the **Name** soft key.
2. Scroll to **Group Edit** by pressing the Up or Down key and press the **Select** soft key or  key.
3. Scroll through the group list by pressing the Up or Down key.
4. When the group you want highlights, press the **Options** soft key or  key.
5. Select each option and change the settings, as required. The following options are available:

Call Ring Tone: allows you to set the ring tone to be used when you receive a voice call from a person in the group.

SMS Tone: allows you to set the ring tone to be used when you receive a text message from a person in the group.



Graphic: allows you to set the graphic icon to be displayed when you receive a voice call from a person in the group.

Group Name: allows you to assign a name to the group. For further details about how to enter characters, see page 51.

6. When you are finished, press the  or  key.

Deleting all of the Phone Book entries

You can delete all of your entries from your phone's memory, your SIM card or both.

1. When the idle screen displays, press the **Name** soft key.
2. Scroll to **Delete all** by pressing the Up or Down key and press the **Select** soft key or  key.
3. To place a check mark by the memory location you want to empty, **All**, **SIM memory**, or **Phone memory**, press the  key.

You can remove the check mark by pressing the  key again.

4. Press the **Delete** soft key to delete the entries in the selected memory location.
5. Enter the phone password and press the **OK** soft key or  key.

Note: The password is preset to “00000000” at the factory. To change this password, see page 167.

6. When the confirmation message appears, press the **Yes** soft key or  key.





To cancel the deletion, press the **No** soft key.

7. When you are finished, press the **C** or  key.

Speed-dialing

Once you have stored phone numbers in the SIM card or phone memory, you can set up to 8 speed-dial entries and then dial them easily whenever you want, simply by pressing the associated number key.



Setting Up Speed-dial Entries

1. At the idle screen, press the **Name** soft key.
2. Scroll to **Speed Dial** by pressing the Up or Down key and press the **Select** soft key or  key.
3. Select the key to which you wish to assign the speed-dialing number, from the  to  keys, and press the **OK** soft key or  key.

Note: Memory location 1 is reserved for your Voice Mail server number.

Note: If you have already assigned a number to the key, the **Options** soft key replaces the **OK** soft key. Go to step 6.

4. Select a Phone Book entry and press the **View** soft key or  key.



5. Select a number if the entry has more than one number, by pressing the Up or Down key and press the **Select** soft key or  key.
6. Once you have assigned a number to the selected key, you can use the following options by pressing the **Options** soft key or  key:

Change: allows you to assign a different number to the key.



Delete: allows you to clear the setting so that no number is assigned to the key.

Delete All: allows you to clear the settings for all keys so that no numbers are assigned to any of the keys.

Number: allows you to view the number assigned to the key.

7. When you are finished, press the  or  key.



Speed-dialing from Phone Book

To speed-dial the numbers assigned to keys  to , press and hold the appropriate key.

Checking the Memory Status



You can check how many names and numbers are stored in Phone Book; SIM card and phone memories. You can also see the capacity of both memories.

1. When the idle screen displays, press the **Name** soft key.
2. Select the **Memory Status** option.

3. Press the Up or Down key to view the number of existing and remaining entries in the SIM card and phone's memory.
4. When you are finished, press the  or  key.

Using the service Dialing Numbers

You can view the list of Service Dialing Numbers (SDN) assigned by your service provider. These numbers include emergency numbers, directory enquiries and voice mail numbers.

1. When the idle screen displays, press the **Name** soft key.
2. Select the **SDN** option by pressing the Up or Down key and press the **Select** soft key or  key.
3. To dial the number displayed, press the **Dial** soft key,  key, or  key.

Entering Text

When using your phone, you often need to enter text, such as when storing a name in Phone Book, creating your personal greeting or scheduling events on your calendar. You can enter alphanumeric characters by using your phone's keypad.

Your phone has the following text input modes:

◆ T9 mode

This mode allows you to enter words with only one keystroke per letter. Each key on the keypad has more than one letter; for example, when you press the  key once, J, K or L displays. The T9 mode automatically compares your keystrokes with an internal linguistic dictionary to determine the correct word, thus requiring far fewer keystrokes than the traditional upper/lower-case character modes.

◆ Character modes

These modes allow you to enter letters by pressing the key labeled with the letter you want to enter once, twice, three or four times until the letter displays.

◆ Symbol mode

This mode allows you to enter symbols, such as punctuation marks.

◆ Number mode

This mode allows you to enter numbers.

Changing the Text Input Mode

When you are in a field that allows characters to be entered, you will notice the text input mode indicator on the display.

Example: Writing a text message

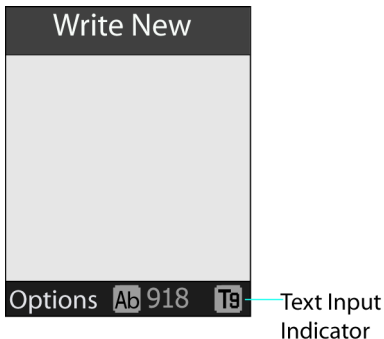

To select	Press the  soft key until
T9 mode	T9 displays. See page 53.
Upper-case character mode	Ab displays. See page 55.
Lower-case character mode	ab displays. See page 55.
Number mode	1 displays. See page 56.

Using T9 Mode

T9 is a predictive text input mode that allows you to key in any character using single keystrokes. This text input mode is based on a built-in dictionary.

To enter a word in T9 mode:

1. When you are in T9 mode, start entering a word by pressing the to keys. Press each key only once for each letter.

Example: To enter “Hello” in T9 mode, press the , , , and keys.

The word you are typing appears on the display. It may change with each key that you press.

2. Enter the whole word before editing or deleting the keystrokes.
3. When the word displays correctly, go to step 4.

If not, press the Up or Down navigation keys to display alternative word choices for the keys that you have pressed.

Example: Both “Of” and “Me” have the and keys. The phone displays the most commonly used choice first.

4. Put a space by pressing the # key and start entering the next word.
- ◆ To type words not found in T9 mode, change the text input mode to the upper/lower-case character input mode.
 - ◆ To enter full stops, hyphens or apostrophes, press the key. T9 mode applies grammar rules to ensure that the correct punctuation is used.

Note: Example: The key is used twice to display two punctuation marks:

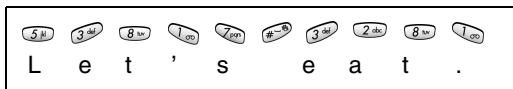

◆ To shift the case in T9 mode, use the * key. There are three cases: Initial capital (**Ab**), Capital lock (**AB**), and Lower case (**ab**).

◆ You can move the cursor by using the Left and Right keys. To delete letters, press the key. Press and hold the key to clear the display.

To add a new word into the T9 dictionary:

1. After pressing the keys corresponding to the word you want to add, press the **0** key or Up or Down key to display the alternative words.
2. When you press the **0** key or Up or Down key at the last alternative word, the display shows **Add** on the bottom line. Press the **Add** soft key or **X** key.
3. If necessary, clear the word using the **C** key and enter the word you want to add using Alphabet mode. See page 55.
4. Press the **OK** soft key or **X** key.
5. The word is added to the T9 dictionary and becomes the first word for the associated keypress series.

Note: This feature may not be available for some languages.

- ◆ To enter periods, hyphens, or apostrophes, press the **1** key. T9 mode applies grammar rules to ensure that correct punctuation is used.
- ◆ To shift case in T9 mode, use the ***** key. There are three cases: Initial capital (**Ab**), Capital lock (**AB**), and Lower case (**ab**).
- ◆ You can move the cursor by using the Left and Right keys. To delete letters, press the **C** key. Press and hold the **C** key to clear the display.

Using the Upper/Lower-Case Character Mode

Use the to keys to enter your text.

1. Press the key labeled with the letter you want:
 - Once for the first letter
 - Twice for the second letter
 - And so on
2. Select the other letters in the same way.

Note: The cursor moves to the right when you press a different key. When entering the same letter twice or a different letter on the same key, just wait for a few seconds for the cursor to move to the right automatically, and then select the next letter.

See the following table for more information about the characters available:

Key	Characters in the order displayed	
	Upper case	Lower case
1	. , - ? ! @ : () / 1	
2	A B C 2 Ä Å Æ Ç Γ	a b c 2 à á â ã
3	D E F 3 É Δ Φ	d e f 3 è é ê ë
4	G H I 4 Θ Ψ	g h i 4 ì í î ï
5	J K L 5 Λ	j k l 5 λ
6	M N O 6 Ñ Ø Ö ö	m n o 6 ñ ø ò ó
7	P Q R S 7 Π Σ Ξ	p q r s 7 ρ σ τ ξ
8	T U V 8 Ü ü	t u v 8 ù ü
9	W X Y Z 9 Ω	w x y z 9 ω
0	Space + = < > € £ \$ % & ¥ ¨ 0 ~	

- ◆ To insert a space, press the **#** key.
- ◆ You can move the cursor by using the Left and Right keys. To delete letters, press the **↶** key. Press and hold the **↶** key to clear the display.

Using Number Mode

Number mode enables you to enter numbers into a text message. Press the keys corresponding to the digits you want to enter.

Using Symbol Mode

Symbol mode enables you to insert symbols into a text message.

To	Press the
select a symbol	corresponding number key.
display more symbols	Up or Down key.
clear the symbol(s)	C key. When the input field is empty, this key returns the display to the previous mode.
insert the symbol(s) into your message	OK soft key or X key.
cancel your input and return to the previous mode	Back soft key.

Options During a Call

Your phone provides a number of control functions that you can use during a call.

Putting a Call on Hold

You can place the current call on hold whenever you want. You can make another call while you have a call in progress if your network supports this service.

To place a call on hold, simply press the **Hold** soft key. You can reactivate the call whenever you want, by pressing the **Unhold** soft key.

To make a call while you have a call in progress:

1. Enter the phone number that you wish to dial or look it up in Phone Book.
2. Press the  key to dial the second call.

The first call is automatically put on hold.

Or

1. Put the current call on hold by pressing the **Hold** soft key.
2. Make the second call in the normal way.

To switch between the two calls, simply press the **Swap** soft key.

The current call is placed on hold and the call on hold is reactivated so that you can continue conversing with the other party.

End each call normally by pressing the  key.

Using the Menu Functions

During a call, you can access the main menu functions.

1. Press the **Options** soft key.
2. Press the **OK** soft key when the **Menu** option highlights.
3. Press the **Up** or **Down** key to scroll through the menu list.

Note: You cannot use some menus during a call. They are deactivated on this list.

4. When the menu you want highlights, press the **Select** soft key.
5. If the selected menu has sub-options, repeat steps 3 and 4.

For further details about the menu functions available, see the list on page 68.

Switching the Microphone Off (Mute)

You can temporarily switch your phone's microphone off, so that the other party cannot hear you.

Example: You wish to say something to another person in the room but do not want the person on the phone to hear you.

To switch the microphone off temporarily:

1. Press the **Options** soft key.
2. If necessary, press the Down key to highlight the **Mute** option.

3. Press the **OK** soft key or **X** key. The other person can no longer hear you.

To switch the microphone back on:

1. Press the **Options** soft key.
2. If necessary, press the Down key to highlight the **Unmute** option.
3. Press the **OK** soft key or **X** key. The other person can hear you again.

Muting/Sending Key Tones

These options allow you to turn the key tones off or on. If the **Mute keys** option is selected, your phone does not transmit the key tones. It allows you to press keys without hearing annoying key tones during a call.

Note: To communicate with answering machines or computerized telephone systems, the **Send keys** option must be selected.

Sending Tones

This option allows you to send the correct type of tones if you need to enter a password or account number when calling an automated system, such as a bank. To send tones:

1. Press the **Options** soft key.
2. Highlight the **Send DTMF** option.
3. Press the **OK** soft key or **X** key.
4. Enter the required number and press the **OK** soft key or **X** key.

Searching for a Number in Phone Book

You can search for a number in Phone Book during a call.

1. Press the **Options** soft key.
2. Press the Down key to highlight the **Phone Book** option.
3. Press the **OK** soft key or **X** key.

The Phone Book entries are listed.

4. Enter the name that you wish to find.

If you enter the first few letters of the name, the Phone Book entries are listed, starting with the first entry matching your input.

5. To view the highlighted entry, press the **View** soft key or **X** key.

For further details about the Phone Book feature, see “Phone Book” on page 39.

Call Waiting

You can answer an incoming call while you have a call in progress, if this service is supported by the network and you have set the **Call Waiting** menu (**Menu 3.3**) to **Activate**; see “Call Waiting” on page 112. You are notified of an incoming call by a call waiting tone.

To answer a call while you have a call in progress:

1. Press the  key to answer the incoming call. The first call is automatically put on hold.

2. To switch between the two calls, press the **Swap** soft key.
3. To end a call on hold, press the **Options** soft key and select the **End Held Call** option.
4. To end the current call, press the  key.

Making a Multi-party Call

A multi-party call is a network service that allows up to six people to take part simultaneously in a multi-party or conference call.

For further details about subscribing to this service, contact your service provider.

Setting up the Multi-party Call



1. Call the first participant in the normal way.
2. Call the second participant in the normal way. The first call is automatically put on hold.
3. To join the first participant to the multi-party call, press the **Options** soft key and select **Join**. Press the **OK** soft key or  key.
4. To add a new person to the multi-party call, call the person in the normal way and then press the **Options** soft key. Select the **Join** option and press the **OK** soft key.

You can add incoming callers by answering the call and pressing the **Options** soft key and selecting **Join**. Repeat as required.

Having a Private Conversation With One Participant

1. Press the **Options** soft key and choose the **Select one** option. Press the **OK** soft key.

The list of call participants appears.

2. Highlight a person by pressing the Up or Down key, and press the **Select** soft key or the  key or  key.
3. When the **Private** option highlights, press the **OK** soft key or  key.

Now you can talk privately to that person. The other participants can continue to converse with each other.



4. To return to the multi-party call, press the **Options** soft key and select **Join**. Press the **OK** soft key or  key.

All of the multi-party call participants can now hear each other.

Dropping One Participant

1. Press the **Options** soft key and choose the **Select one** option. Press the **OK** soft key or  key.

The list of call participants appears.

2. Highlight a person by pressing the Up or Down key, and press the **Select** soft key or the  key or  key.
3. Press the Down key to select the **Remove** option and press the **OK** soft key or  key.

The call ends with that participant, but you can continue to talk to the other participants.

4. When you want to end the multi-party call, press the  key.

Using the Menus

You can tailor the phone's range of functions to your needs using menus and sub-menus. Menus and sub-menus can be accessed by scrolling using the Navigation keys or by using the shortcuts.

Accessing a Menu Function by Scrolling

1. In Idle mode, press the **Menu** soft key.
2. Scroll using the Up and Down keys to reach a main menu, **Phone Settings** for example. Press the **Select** soft key or **X** key to enter the menu.
3. If the menu contains sub-menus, **Language** for example, you can access them by scrolling and pressing the **Select** soft key or **X** key.

If the menu that you have selected contains further options, repeat this step.

To	Press the
scroll through the menus	Up or Down keys or use the ▲ and ▼ keys.
confirm the chosen setting	Select soft key or X key.
return to the previous menu level	↶ key or the Right soft key.



To	Press the
exit the menu without changing the settings	 key.

Accessing a Menu Function by Using Its Shortcut

The menu items, such as menu, sub-menus and options, are numbered and can be accessed quickly by using their shortcut numbers. The shortcut number is shown at the bottom right next to the  soft key on the display. Simply press the **Menu** soft key and enter the number of the menu you want.

Note: The numbers assigned to each menu are indicated on the list on the next page. They may not match the menu number on the phone, depending on the services supported by your SIM card.

Example: Accessing the **Language** menu.

1. Press the **Menu** soft key.
2. Press the  key for **Phone Settings**.
3. Press the  key for **Language**.

The languages available display.

List of Menu Functions

The following list shows the menu structure available and indicates the number assigned to each option and the page where you can find a description of each feature.

Note: If you use a SIM AT card that provides additional services, the **SIM AT** menu displays when you press the **Menu** soft key to enter Menu mode. For further details, see your SIM card instructions.

1. Recent Calls

- 1.1 Missed Calls
- 1.2 Calls Received
- 1.3 Calls Made
- 1.4 Voice Mail
- 1.5 Delete All
- 1.6 Call Time
 - 1.6.1 Last Call Time
 - 1.6.2 Total Sent
 - 1.6.3 Total Received
 - 1.6.4 Reset Timers

2. Messaging

- 2.1 Text Messages
 - 2.1.1 Write New
 - 2.1.2 Inbox
 - 2.1.3 Outbox
 - 2.1.4 Templates
 - 2.1.5 Settings
 - 2.1.6 Delete All
 - 2.1.7 Memory Status
 - 2.1.8 Broadcast
- 2.2 Multimedia Messages
 - 2.2.1 Write New
 - 2.2.2 Inbox
 - 2.2.3 Outbox
 - 2.2.4 Shop Multimedia
 - 2.2.5 Draft
 - 2.2.6 Templates
 - 2.2.7 Delete All
 - 2.2.8 Memory Status
 - 2.2.9 Setup
 - 2.2.10 MMS Profile
- 2.3 IM

- 2.4 Push Messages
 - 2.4.1 Inbox
 - 2.4.2 Receive
 - 2.4.3 Delete All

3. Network Services

- 3.1 Call Forwarding
 - 3.1.1 Forward Always
 - 3.1.2 Busy
 - 3.1.3 No Reply
 - 3.1.4 Unreachable
 - 3.1.5 Cancel All
- 3.2 Call Barring*
- 3.3 Call Waiting
 - 3.2.1 Voice Calls
 - 3.2.2 Data Calls
 - 3.2.3 Cancel All
- 3.4 Network Selection
 - 3.4.1 Automatic
 - 3.4.2 Manual
- 3.5 Caller ID
 - 3.5.1 Default
 - 3.5.2 Hide Number
 - 3.5.3 Send Number
- 3.6 Closed User Group*

4. Games

- 4.1 Shop Games
- 4.2 BubbleSmile
- 4.3 Fun2Link
- 4.4 MobileChess
- 4.5 Ultimate Golf Challenge

5. MEdia Mall

- 5.1 Shop Ringtones
- 5.2 Shop Games
- 5.3 Shop Graphics
- 5.4 Shop Multimedia
- 5.5 Shop Applications
- 5.6 MEdia Home

6. Sound Settings

- 6.1 Ring Tone
- 6.2 Ring Volume
- 6.3 Shop Ringtones
- 6.4 Alert Type
 - 6.4.1 Melody
 - 6.4.2 Vibration
 - 6.4.3 Vibra+Melody
- 6.5 Keypad Tone
 - 6.5.1 Off
 - 6.5.2 Cool
 - 6.5.3 Piano
 - 6.5.4 Tone
 - 6.5.5 Beep
- 6.6 Message Tone
 - 6.6.1 SMS Tone
 - 6.6.2 SMS-CB Tone
 - 6.6.3 MMS Tone
- 6.7 Alerts On Call
 - 6.7.1 Off
 - 6.7.2 On
- 6.8 Power On/Off
 - 6.8.1 Off
 - 6.8.2 Classical
 - 6.8.3 Cheerful
- 6.9 Extra Tones

7. Applications

- 7.1 Alarm

- 7.1.1 Once Alarm
- 7.1.2 Daily Alarm
- 7.1.3 Wake-Up Call
- 7.1.4 Remove Alarm
- 7.1.5 Autopower
- 7.2 Calendar
- 7.3 Time & Date
 - 7.3.1 Set Time
 - 7.3.2 Set Date
 - 7.3.3 World Time
 - 7.3.4 Time Format
 - 7.3.5 Auto Update
- 7.4 Calculator
- 7.5 To Do List
- 7.6 Voice Memo
 - 7.6.1 Record
 - 7.6.2 Memo List
 - 7.6.3 Delete All
 - 7.6.4 Memory Status
- 7.7 Currency Exchange
- 7.8 SIM-AT*

8. My Media

- 8.1 MEdia Net
 - 8.1.1 Home
 - 8.1.2 Favorite
 - 8.1.3 http://
 - 8.1.4 Settings
 - 8.1.5 Clear Cache
- 8.2 Audio
- 8.3 Graphics
- 8.4 Delete All
- 8.5 Memory Status

9. Phone Settings

- 9.1 Display Settings
 - 9.1.1 Wallpaper
 - 9.1.2 Menu Style

Using the Menus

- 9.1.3 Shop Graphics
- 9.1.4 Auto Key Lock
- 9.1.5 Contrast
- 9.1.6 Back Light
- 9.1.7 Graphic Logo
- 9.2 Greeting Message
- 9.3 Own Number
- 9.4 Language
- 9.5 Security
 - 9.5.1 PIN Check
 - 9.5.2 Change PIN
 - 9.5.3 Phone Lock
 - 9.5.4 Change Password
 - 9.5.5 Privacy
 - 9.5.6 SIM Lock
 - 9.5.7 FDN Mode
 - 9.5.8 Change PIN2*
- 9.6 Extra Settings
- 9.7 Short Cut
- 9.8 Reset Settings
- 9.9 TTY Setting

* Shows only if supported by your SIM card.

10.

Recent Calls

In this menu, you can view the:

- ◆ calls you missed, received or dialed.
- ◆ length of your calls.

Note: You can access the numbers in the three types of call records by pressing the  key in Idle mode.

Missed Calls

This menu lets you view the numbers of the last 20 unanswered calls.

The number and name, if available, display together with the date and time when the call was received.

By pressing the **Options** soft key or  key, you can:

- ◆ delete the call from the list.
 - ◆ edit the number, if available, and save it in Phone Book.
- You can also dial the number by pressing the  key.

Calls Received

This menu lets you view the last 20 numbers of the calls you answered.

The number and name, if available, display, together with the date and time when the call was received.

By pressing the **Options** soft key or  key, you can:

- ◆ delete the call from the list.
 - ◆ edit the number, if available, and save it in Phone Book.
- You can also dial the number by pressing the  key.

Calls Made

This menu lets you view the last 20 numbers you dialed.

The number and name display, together with the date and time when the call was made.

By pressing the **Options** soft key, you can:

- ◆ delete the number.
 - ◆ edit the number and save it in Phone Book.
- You can also dial the number by pressing the  key.

Voice Mail

This menu provides you with a way of accessing your voice mailbox, if provided by your network.

The following options are available:

Connect to Voice Mail: before using the Voice Mail feature, you must enter the voice server number obtained from your service provider. You can then select this option and press the **OK** soft key or  key to listen to your messages.

You can connect to the voice server by pressing and holding the  key in Idle mode.

Voice Mail Number: allows you to change the voice mail server number, if necessary.

To	Press the
enter the server number	corresponding numeric keys.
correct a digit	C key.
move the cursor to the left/right without clearing the digit	Left or Right key.

Note: Voice Mail is a network feature. Please contact your service provider for further details.

Delete All

You can delete all of the numbers stored in each call record category.

Select a call record using the Up or Down key and press the ✕ key to mark your selection. Press the **Delete** soft key. When a confirming message appears, press the **Yes** soft key or ✕ key.

Call Time

This menu lets you view the timers for calls you made and received.

Note: The actual time invoiced for calls by your service provider may vary, depending on network features, such as rounding-off for billing purposes.

The following options are available:

Last Call Time: length of the last call.

Total Sent: total length of all calls you made since the timer was last reset.

Total Received: total length of all calls you received since the timer was last reset.

Reset Timers: option used to reset the call timers. You must first enter the phone password and then press the **OK** soft key or ✕ key.

Note: The password is preset to "00000000." To change this password, see "Change Password" on page 157.

Messaging

In this menu, the following menu options are explained:

- ◆ Text Messages
- ◆ Multimedia Messages
- ◆ Instant Messages (IM)
- ◆ Push Messages

Text Messages

Short Message Service (SMS) allows you to send and receive short text messages to and from other mobile phones. In addition, your phone supports the Enhanced Messaging Service (EMS), which enables you to include simple pictures, melodies, and animated images in your messages.

When the Message icon () appears, you have received new text messages. When the memory is full, an error message displays and you cannot receive any new messages. Use the **Delete** option in each message box to delete obsolete messages.

Write New

In this menu, you can write and send a text message.

Note: When you add media items to the message, the number of characters you can enter decreases.

Note: To create and send a message to an Email address you must first change the option in **Settings** (Menu 2.1.5). See Email Settings on page 85 for more details.

Creating a Simple Text Message

1. Create your message.

Note: For more information about entering characters, see “Entering Text” on page 51.

2. When you finish entering your message, press the **Options** soft key or **X** key. The following options are available:

Send Only: allows you to send the message. The message is deleted after sending.

Save and Send: allows you to save a copy of the message to the Outbox and then send the message.

Save Only: allows you to save the message in the Outbox so that it can be sent later.

For more information about the **Text Formatting, Add Content, Add Templates, Add Phonebook, Add Bookmark** and **Language** options, see page 84.

3. Select **Send** or **Save and Send**, and press the **Select** soft key or **X** key.

If you only want to save the message, select **Save**. After saving the message, the phone returns to the **Messaging** menu.

4. If you select a save option, select a location and press the **OK** soft key or **X** key.

5. Enter a destination number and press the **OK** soft key or **X** key. The message is sent.

Note: When the phone fails to send the message, it asks you if you want to retry. Press the **OK** soft key or **X** key to confirm. Otherwise, press the **Exit** soft key to return to the message screen.

Creating a Message Using the Options

1. Create your message.
2. Press the **Options** soft key or **X** key.
3. Select one of the following options by using the Up and Down keys and pressing the **Select** soft key or **X** key.

Text Formatting: allows you to format the style of the text. For the **Size** attribute, **Normal**, **Large** and **Small** sizes are available. For the **Underline** and **Strikethrough** attributes, select **On** or **Off**.

The attributes can be combined.

Add Content: allows you to add a sound, melody, picture or animated image to your message. Select the category of the item to be added. In each category, you can select from the various factory-set items or choose an item received from other sources, such as the Internet or other phones.

Add Templates: allows you to apply one of the preset message templates to the text. Select one of the five messages stored in the **Templates** menu. For further details, see page 84.

Add Phonebook: allows you to add a Phone Book entry to your message. Select one from the list.

Add Bookmark: allows you to add a web page's address stored in your Favorite list. Select one from the list.

Language: allows you to change the language to be used in T9 input mode. Select the language to be used.

4. Complete the message, and send or save it by following the procedure from step 2 on page 80.

Inbox

This message box is used to store the messages that you have received.

When you enter this menu, the list of messages displays with the senders' phone numbers or names, if available in your Phone Book.

1. Select a message from the list and press the **View** soft key or **X** key to read the message contents.
2. To scroll through the contents, press the Up or Down key.
3. To scroll to the previous message press the ***** key or press the **#** key for the next message.

While reading a message, you can choose the following options by pressing the **Options** soft key or **X** key:

Delete: allows you to delete the message.

Forward: allows you to resend the message. For further information about how to send a message, see page 80.

Text Reply: allows you to reply to the sender by sending a text message.

Call Back: allows you to call the sender back.

Save Address: allows you to extract the sender's number and URL, e-mail addresses or phone numbers from the message text, so that you can save them in your phone's memory.

Move to Phone: allows you to move the message to another memory location, from the SIM card to the phone's memory or vice versa.

Select Objects: allows you to save media items, such as sounds or images, from the message into your phone's memory. You can then use the items when writing a message. For details, see page 81.

Outbox

This message box is used to store the messages that you have already sent or will send.

When you enter this menu, the list of messages in the box displays with the recipients' phone numbers or names, if available in your Phone Book.

1. Select a message from the list and press the **View** soft key or **X** key to read the message contents.
2. To scroll through the contents, press the Up or Down key.
3. To scroll to the previous message press the * key or press the # key for the next message.

While reading a message, you can choose the following options by pressing the **Options** soft key or **X** key:

Delete: allows you to delete the message.

Send: allows you to resend the message. For further information about how to send a message, see page 80.

Save Address: allows you to extract the destination number and URL, e-mail addresses or phone numbers from the message text, so that you can save them in your phone's memory.

Move to Phone: allows you to move the message to another memory location, from the SIM card to the phone's memory or vice versa.

Select Objects: allows you to save the media items, such as sounds or images, from the message into your phone's memory. You can then use the items when writing a message. For details, see page 81.

Templates

Using this menu, you can preset messages that you use most frequently.

Select an empty location or the message template you want and press the **Select** soft key or ✕ key.

The following options are available:

Edit: allows you to write a new message or edit the message.

Note: For further details about how to enter characters, see "Entering Text" on page 51.

Send Message: allows you to retrieve the message. Once you have completed the message, you can send, save and send, or simply save it. For details about how to send a message, see page 79.

Delete: allows you to delete the message. You are asked to confirm the deletion by pressing the **Yes** soft key or ✕ key.

Settings

In this menu, you can set up default message information. A setting group is a collection of settings required to send

messages. The number of setting groups available depends on the capacity of your SIM card.

Note: The last setting you accessed is automatically activated for sending messages.

SMS Settings: the following options are available:

Service Center: allows you to store or change the number of your message center, which is required when sending messages. You must obtain this number from your service provider.

Default Destination: allows you to store the default destination number. The number automatically displays on the Destination screen when you create a message.

Default Type: allows you to set the default message type to **Text**, **Fax**, **Email** or **Paging**. The network can convert the messages into the selected format.

Default Validity: allows you to set the length of time your text messages are stored at the message center while attempts are made to deliver them.

Setting Name: allows you to give a name to the setting group currently being defined.

Email Settings: the following settings are provided for Email options:

Service Center: allows you to store or change the number of your message center, which is required when sending messages. You must obtain this number from your service provider.

Default Destination: allows you to store the default destination number. The number automatically displays on the Destination screen when you create a message.

Default Type: allows you to set the default message type to **Text, Fax, Email** or **Paging**. The network can convert the messages into the selected format.

Default Validity: allows you to set the length of time your text messages are stored at the message center while attempts are made to deliver them.

Setting Name: allows you to give a name to the setting group currently being defined.

Empty: this setting is available to input a personalized name and specific settings. The following options are available:

Service Center: allows you to store or change the number of your message center, which is required when sending messages. You must obtain this number from your service provider.

Default Destination: allows you to store the default destination number. The number automatically displays on the Destination screen when you create a message.

Default Type: allows you to set the default message type to **Text, Fax, Email** or **Paging**. The network can convert the messages into the selected format.

Default Validity: allows you to set the length of time your text messages are stored at the message center while attempts are made to deliver them.

Setting Name: allows you to give a name to the setting group currently being defined.

Common Setting: The following options are available:

Reply Path: allows the recipient of your message to send you a reply message using your message center, if your network supports this service.

Delivery Reports: allows you to activate or deactivate the report function. When this function is activated, the network informs you whether or not your message has been delivered.

Bearer Selection: allows you to choose either **GSM** or **GPRS**, depending on your network.

Delete All

This menu allows you to delete all of the text messages in each message box separately. You can also delete all of your messages at one time.

To	Press the
select a message box to clear	Up or Down key. To delete all of your messages, select All messages .
place or remove a check mark	✕ key.
delete the marked objects	Delete soft key.

When a confirmation message displays, press the Yes soft key or ✕ key to confirm.

Memory Status

You can check how many messages are currently stored in the SIM and phone memories.

Press the Up or Down key to view the number of messages you stored and the total number of messages you can store in the SIM and phone memories.

Broadcast

This network service allows you to receive text messages on various topics, such as the weather or traffic. Cell Broadcasting (CB) messages display as soon as they are received, provided that:

- ◆ the phone is in Idle mode.
- ◆ the Receive option is set to Enable.
- ◆ the message channel is currently active on the channel list.

Note: Your carrier must subscribe and support this feature.

The following options are available:

Read: lets you view the message. **Volatile** displays the messages from the network, but loses its contents as soon as the phone is switched off. Scroll through the message using the Up and Down keys. While reading a message, press the **Save** soft key to store the message in the **Archive** box for later retrieval.

Receive: allows you to enable or disable the reception of broadcast messages.

Channel List: allows you to indicate the channels from which you wish to receive cell broadcast messages. The following options are available:

Select: used to enable or disable channels on the list by marking or unmarking them respectively.

Add Channel: used to enter the ID and title for a new channel.

Delete: used to remove a channel from the list.

Edit: used to change the ID and title of an existing channel.

Language: allows you to select your preferred language to be used when displaying cell broadcast messages. Please contact your service provider for more information.

Multimedia Messages

Multimedia Message Service (MMS) is a messaging service very similar to Short Message Service (SMS). It provides automatic and immediate delivery of personal multimedia messages from phone to phone or from phone to e-mail. In addition to the familiar text content of text messages, multimedia messages can contain images, audio clips, and graphics. An MMS message is a multimedia presentation in a single entry. It is not a text file with attachments. Using the MMS feature, your phone can receive multimedia messages. You can also send picture messages, which are short messages that contain images, such as your photos or graphics you downloaded from the Internet. This function is available only if it is supported by your service provider. Only phones that offer picture message features can receive and display picture messages.

Write New

This menu option allows you to create a new picture message and then send it to multiple destinations.

Creating and Sending a Picture Message

1. Enter the subject of your message and press the **OK** soft key or **✕** key.

For further details about entering characters, see page 51.

2. When **Add Here** highlights, press the **Options** soft key or **✕** key and add the message contents using one of the following options:

Add text: enter the message text and press the OK soft key or **✕** key.

Add Picture: allows you to add a photo stored in the Graphics folder (Menu 8.3). You can add downloaded images if they are in correct format and your service provider supports them.

Add Sound: allows you to add a sound file. Select Record to record a new voice memo or Sound list to add one of the voice memos stored in the phone. You can add downloaded sounds if your service provider supports them.

Send: allows you to send the message. Use this option when you have finished creating the message.

Save: saves the message in the Draft (Menu 2.2.5) or Templates (Menu 2.2.6) box for later use.

Settings: allows you to change the message settings. For further details about each setting option, see page 100. After changing the settings, you need to press the **↶** soft key or the C key to go to back to the options screen.

Add destination: allows you to enter destination numbers or addresses. See steps 6 to 11. After adding them, you

need to press the  soft key or the C key to go to back to the options screen.

Preview: shows the message you created.

Note: You can add text, an image, and a sound only once for each page.

3. Repeat step 2 until you have finished creating your message.
4. If you want to change the added items, press the Up or Down key to highlight one and press the **Options** soft key or  key.

Note: Available options are different, depending on whether the item you select on the message screen is text, an image, a sound, or the Page field.

The following options are available:

Edit text/picture/sound: allows you to change the text or replace the image or sound with another one.

Add page: allows you to add more pages. After you add a page, the display shows you the current page number and the memory space used for the page. You can move to each page using the Left or Right key on the message screen.

Delete: deletes the item from your message.

Duration: allows you to set when and how long text, an image, a sound, or a page displays on the message presentation screen. If the duration you set is shorter than the content duration (for example, the length of sound clip) for a particular page, the content duration is automatically decreased.

Send: allows you to send the message.

Save: saves the message in the Draft (Menu 2.2.5) or Templates (Menu 2.2.6) box for later use.

Settings: allows you to change the message settings. For further details about each setting option, see page 100.

Add Destination: allows you to enter destination addresses. See steps 6 to 11.

Preview: shows the message you created.

5. When you have finished creating the message, choose **Send** and press the **Select** soft key or ✕ key.
6. Select a destination type, **To, Cc, or Bcc**, and press the **Select** soft key or ✕ key.
7. Choose one of the following options and press the **Select** soft key or ✕ key:

Phone number: allows you to enter a destination phone number.

E-Mail Address: allows you to enter the e-mail address of the recipient.

Phone book: allows you to retrieve a number from your Phone Book.

8. Enter a number or an e-mail address, or select a number from Phone Book.
9. When the correct number or address displays, press the **OK** soft key or ✕ key.
10. To add a destination, press the **Select** soft key or ✕ key when **Add destination** highlights. Repeat from step 7.

If you want to edit the destinations, select one and press the **Select** soft key or  key. You can change or delete it.

11. To enter additional numbers or addresses to the other destination types, press the **C** key or the  key and repeat steps 6 through 10.

You can enter up to 10 destinations each for To, Cc, and Bcc.

12. When you have finished entering the destinations, select **Send message** and press the **Select** soft key or  key.

Your phone sends the message.

Inbox

Viewing a Message When You Receive it

When a new multimedia message comes in, the display shows the text notification along with the sender's number.

1. Press the **View** soft key or  key to view the message.

The display shows brief information about the message, such as the sender's number, the message size and the subject. If you want to view the message later in the Inbox, press the  soft key.

2. To scroll through the message information, press the Up or Down key.

While viewing the information, press the **Options** soft key or  key to use the following options:

If you are viewing a new message, the options are the same as when you view a message as soon as you receive it.

When you are reviewing message, the following options are available:

Delete: deletes the message.

Reply: allows you to reply to the sender by sending a text or multimedia message.

Call back: allows you to call the sender.

Save address: allows you to extract the sender's number or e-mail address and URL, other e-mail addresses or phone numbers from the message text.

Forward: allows you to forward the message to another person.

Save picture: allows you to save an image from the message into your phone. Images are stored in the Graphics folder (Menu 8.3).

Save sound: allows you to save a sound from the message into the Audio folder (Menu 8.2).

Properties: shows you information about the message, such as the subject, sender's e-mail address or phone number, message size, recipient's e-mail address or phone number, its priority, and the time and date the message was received.

3. To read the message, press the **Select** soft key or **X** key when **Retrieve** is highlighted.







Your phone retrieves the message contents from the server and displays it.

4. To scroll through the message, press the Up or Down key.

When you are finished, press the  key

Viewing a Received Message in the Inbox

When you access the **Inbox** menu option, the list of multimedia messages you received displays with the senders' phone numbers, if they are available in your Phone Book, or subjects.

- ◆ : MMS notifications that have been opened.
- ◆ : MMS notifications that are unopened.
- ◆ : MMS notifications that you sent an inquiry to the MMS server for retrieving the message.
- ◆ : MMS notifications that the phone is retrieving the messages from the MMS server.
- ◆ : MMS notifications that the phone couldn't retrieve the message.
- ◆ : Messages that have been opened.
- ◆ : Messages that are unopened.

1. Select a message on the list and press the **Select** soft key or  key.

The message displays and scrolls to the next page, if it has one, after a specified time.

2. Press the **OK** soft key or  key to go to the message view screen.

Or, the display automatically switches to the screen.

3. To scroll through the message, press the Up or Down key.

If the message has more than one page, you can scroll through the pages by using the Left and Right keys.

4. To scroll to the previous or next message, press the # or * key.

While viewing a message, you can choose the Message options by pressing the **Options** soft key or ✕ key.

If you are viewing a new message, the options are the same as when you view a message at the time of its receipt. See the previous section.

When you are reviewing a message retrieved from the MMS server, the following options are available:

Delete: deletes the message.

Reply: allows you to reply to the sender by sending a text or multimedia message.

Call back: allows you to call the sender.

Save address: allows you to extract the sender's number or e-mail address and URL, other e-mail addresses or phone numbers from the message text.

Forward: allows you to forward the message to another person.





Save picture: allows you to save an image from the message into your phone. Images are stored in the Graphics folder (Menu 8.3).



Save sound: allows you to save a sound from the message into the Audio folder (Menu 8.2).

Properties: shows you information about the message, such as the subject, sender's e-mail address or phone number, message size, recipient's e-mail address or phone number, its priority, and the time and date the message was received.

Outbox

When you access this menu option, the list of the picture messages you sent or saved displays.

- ◆ : Messages currently being sent
- ◆ : Messages sent
- ◆ : Messages your phone couldn't send
- ◆ : Messages to be sent
- ◆ : Messages deferred

1. Select a message and press the **Select** soft key or  key to view the message contents.
2. Press the **OK** soft key or  key to go to the message view screen.
3. To scroll through the message, press the Up or Down key.

If the message has more than one page, you can scroll through the pages by using the Left and Right keys.

4. To scroll to the previous or next message, press the * or # key.

While viewing a message, you can choose the following options by pressing the **Options** soft key or  key:

Delete: allows you to delete the message.

Save address: allows you to extract the destination numbers or e-mail addresses and URL, e-mail addresses or phone numbers from the message text.

Send: allows you to send/resend the message.

Edit message: allows you to change the message contents, sound, image, or text.

Properties: shows you information about the message, such as the status, subject, sender's e-mail address or phone number, message size, transaction ID, MMS version, and the time and date the message was sent.

Shop Multimedia

This menu allows you to access the web site preset by your service provider to download images or sounds. Once you have downloaded sounds or images, they are saved in the Audio folder (Menu 8.2) or Graphics folder (Menu 8.3) respectively.

Draft

This menu option allows you to create a message and save it to the Draft folder to send at a later time.

Templates

This menu stores messages you saved as templates so that you can use them to make new messages.

1. Scroll through the template list using the Up and Down keys.
2. When the message template you want highlights, press the **Select** soft key or **X** key.
3. Press the **OK** soft key or **X** key to access the following options, or the display automatically shows the options after a specified time:

Edit message: allows you to send a message using the template. For further details about how to send a message, see page 90.

Delete: allows you to delete the message template. You are asked to confirm the deletion by pressing the Yes soft key or ✕ key.

Press the  key to return to Idle mode.

Delete All

This menu allows you to delete all of the multimedia messages in each message box separately. You can also delete all of your messages at one time.

To	Press the
select a message box to clear	Up or Down key. To delete all of your messages, select All messages .
place or remove a check mark	✕ key.
delete the marked messages	Delete soft key.

When a confirmation message displays, press the **Yes** soft key or ✕ key to confirm.

Memory Status

This menu shows how many messages are currently stored in the phone memory.

Setup

You can change the default message settings.

Turn a give option on or off, press the **Select** soft key to place or remove a check mark on each option

The following options are available:

Delivery Report: When this option is checked, the network informs you whether or not your message has been delivered.

Read Reply: When this option is checked, your phone sends a request for a reply along with your message to the recipient.

Auto Download: When this option is checked, your phone automatically downloads the received pictures or sounds.

Off: you need to manually download new messages by using the **Retrieve** option.

On: the phone automatically retrieves new messages from the server. As soon as you receive a message you can use more options while you are reading. See page 96 for further details about the options.

Message Acceptance: you can specify the category of messages you want to receive.

Expiry Date: When this option is selected, you can select the expiry time limit you would like the message to display.

Delivery time: you can set a time delay before the phone sends your messages.

Priority: you can select the priority level of your messages.

Report allowed: when this option is enabled, the sender of an incoming message receives a delivery report from the network.

Page duration: you can set the length of time one page of an incoming message displays on the message presentation screen. After a specified time, the display automatically scrolls to the next page.

MMS Profile

In this menu, you can configure various settings that are required when you send or receive multimedia messages.

Note: The Cingular settings should not be changed in order to allow MMS to be sent on the Cingular network.

The following options are available:

Cingular MMS: Service provider name.

Profile Name: Name that you wish to assign to the MMS server.

Connection URL: Address of your MMS server.

Security: Data transmission mode. Choose **Secure** to protect your data against unauthorized access; otherwise, choose **Non-Secure**.

IP Address: Gateway address required to connect to the MMS server.

User Name: User ID required to connect to the MMS server.

Password: Password required to connect to the MMS server.

APN: Access point name used for the address of the MMS server. For further details, contact your service provider.

Profile x Info: Service provider name.

Use this menu option to select different profile settings than the Cingular default.

Profile Name: Name that you wish to assign to the MMS server.

Connection URL: Address of your MMS server.

Security: Data transmission mode. Choose **Secure** to protect your data against unauthorized access; otherwise, choose **Non-Secure**.

IP Address: Gateway address required to connect to the MMS server.

User Name: User ID required to connect to the MMS server.

Password: Password required to connect to the MMS server.

APN: Access point name used for the address of the MMS server. For further details, contact your service provider.

Instant Messaging (IM)

The instant messaging option allows you to send and receive instant messages using AOL® Instant Messenger™ service or ICQ®.

AOL Instant Messenger Service (AIM®)

You must already have an AIM Screen name and password to log in. If you don't have an AIM screen name, you can get one free at www.aim.com.

Follow these easy steps to log in:

1. Highlight **IM** (Menu 2.3) and press the **Select** soft key.
2. Use the navigation keys to highlight the AIM. Press the **Select** soft key.

3. Enter your Screen name and Password. Press the **Sign on** soft key.
4. If the sign-on was successful, you will see *Welcome*, followed by a list of options.

Buddy List Group

The first time you sign on to AIM from your phone, a special Buddy List group is created. When you sign back on to AIM from your computer, this list appears as a new group called Mobile Device. You can manage this list using your PC or your phone.

Send an Instant Message

1. From the AIM main menu, scroll to and select **Buddy List**.
2. Use the navigation keys to highlight a buddy and press the **Select** soft key or **X** key.

The following information is listed:

Send IM: This option launches the IM screen for you to begin entering text.

Buddy info: This option provides information about the buddy you have selected. It displays their status, screen name, and client type.

Set Alert: This option sets an alert for the buddy when they have activity on their session. To release the alert, highlight release alert and press the **Select** soft key.

Block IMs: This option blocks any messages from the buddy you have selected.

Add Buddy: This option allows you to add another AIM user to the conversation.

Delete buddy: This option deletes the selected buddy from your buddy list.

Search: This option allows you to search for an AIM user by their Screen name or E-mail address.

Menu

The **Menu** screen provides the following options:

Conversations

This function displays the conversations that you have active. To select and view a conversation, press the **Select** soft key or  key.

Blocked List

The blocked list shows all buddies that you have blocked from sending you instant messages. The  icon displays next to the screen name.

IM Settings

The instant message (IM) settings screen gives you the option to save your password so that you do not have to enter it each time you log on. Use the up and down navigation keys to highlight the option. Press the **Select** soft key or  key to save.

Saved history

This option provides the ability to save the conversations you've had on your phone.

Exit

This option exits you from the AIM Screen but does not log you off the system.





Sign Off



This option will sign you off and end all conversations. To sign off, press the **OK** soft key or **X** key. To cancel, press the **Cancel** soft key.

The following table lists the icons associated with the Buddy List.

Status Icons

The Buddy List displays an icon to the left of each user to show their status. The following table describes what these icons represent.

Icon	Description
	You have new/unread messages from this user.
	Messages from this user are being declined.
	This user is online but has turned on their Away Message.
	You will be alerted when this user signs on.

	This user is online.
	This user is not online.

ICQ®

You must already have an ICQ Screen name and password to log in. If you don't, you can get one free from www.icq.com. Follow these easy steps to log in:

1. Scroll right on the navigation key to highlight the ICQ icon. Press the **Select** soft key or **X** key.
2. Enter your ICQ number and Password. Press the **Connect** soft key. The Contact List screen displays with the My Status option highlighted.
3. Press the **Select** soft key. The following options are displayed.

My Availability: This option allows you to set your availability to Available, Away, or Invisible. Use the Up or Down navigation keys to highlight an option and press the **Select** soft key.

Add user: This option allows you to enter another user's ICQ #.

Search: This option allows you to search for another user by entering their ICQ # or their E-mail address.

Send message to: This option allows you to enter an ICQ # and begin a conversation.

Blocked List: This option displays the list of members blocked from sending you instant messages.

Menu

The **Menu** screen provides the following options:

Conversations

This function displays the conversations that you have active. To select and view a conversation, press the **Select** soft key or **X** key.

Blocked List

The blocked list shows all buddies that you have blocked from instant messages.

Saved history

This option provides the ability to save the conversations you've had on your phone.

Exit

This option exits you from the ICQ Screen but does not log you off the system.

Disconnect

This option will sign you off and end all conversations. To sign off, press the **OK** soft key or **X** key. To cancel, press the **Cancel** soft key.

Cingular Wireless IM, Future 1, Future 2

With IM, you have the choice of selecting the instant messaging service you want to use. Since each instant messaging service has its own display text and icons

associated with it, the display text and icons may display differently than what is displayed in this user guide. If you have any questions about the differences in the various networks' display text and icons, contact your service provider for more information.

Push Message

This menu option allows you to receive and access web messages from the server.

The following options are available:

Inbox: allows you to read the messages received from the web server.

Receive: allows you to set whether or not your phone receives web messages.

Delete All: allows you to delete all of the web messages.

Network Services

These menu functions are network services. Please contact your service provider to check their availability and subscribe to them, if you wish.

Call Forwarding

This network service enables incoming calls to be rerouted to the number that you specify.

Example: You may wish to forward your business calls to a colleague while you are out of the office.

To set your call forwarding options:

1. Select a call forwarding option by pressing the Up or Down key and then press the **Select** soft key or **X** key.

The following options are available:

Forward Always: all calls are forwarded.

Busy: calls are forwarded when you are already on another call.

No Reply: calls are forwarded when you do not answer the phone.

Unreachable: calls are forwarded when you are not in an area covered by your service provider.

Cancel All: all call forwarding options are canceled.

2. Select the type of calls, voice or data, by pressing the Up or Down key and then press the **Select** soft key or **X** key.

The current status displays. If the option has already been set, the number to which the calls are forwarded displays.

To	Press the
activate call forwarding	Activate soft key. Go to step 3.
change the call number	Change soft key. Go to step 3.
deactivate call forwarding	Remove soft key.

3. Enter the number to which the calls are to be forwarded and press the **OK** soft key or **X** key.

The phone sends your settings to the network and the network's acknowledgement displays.

You can deactivate all call forwarding settings by selecting the **Cancel All** option.

Call Barring

The call barring network service allows you to restrict your calls.

Note: This option must be supported by your carrier and subscription is required.

You can use the following options to restrict voice and/or data calls:

All Outgoing: calls cannot be made.

International: international calls cannot be made.

International Except to Home: when abroad, calls can be made only to numbers within the current country and to your home country, which is the country where your home network provider is located.

All Incoming: calls cannot be received.

Incoming While Abroad: calls cannot be received when you are using your phone outside of your home service area.

Cancel All: all call barring settings are deactivated; calls can be made and received normally.

To Set Your Call Barring Options

1. Select a call barring option by pressing the Up or Down key and then press the **Select** soft key or **X** key.
2. Select the type of calls, voice or data, by pressing the Up or Down key and then press the **Select** soft key or **X** key.
3. Press the **Activate** soft key to confirm your settings.
4. Enter your call barring password supplied by your service provider.

The phone sends your settings to the network and the network's acknowledgement displays.

To Deactivate Specific Call Barring Settings

1. Select the call barring option to be deactivated.
2. Select the type of calls to which this option applies.
3. Press the **Deactivate** soft key.

4. Enter your call barring password supplied by your service provider.

The phone sends your settings to the network and the network's acknowledgement displays

You can also deactivate all call barring settings by selecting the **Cancel All** option.

Change Barring Password: you can set and change the call barring password obtained from your service provider using this option. You must enter the current password before you can specify a new one.

Once you have entered a new password, you are asked to confirm it by entering it again.

Call Waiting

This network service informs you when someone is trying to reach you during another call.

You can specify individual call waiting options for voice calls and/or data calls.

To set your call waiting options:

1. Select the type of calls, voice or data, to which the call waiting option is to be applied by pressing the Up or Down key and then press the **Select** soft key or **X** key.

The screen informs you whether call waiting is activated or deactivated.

2. You can activate or deactivate the call waiting feature using the **Activate** or **Deactivate** soft key respectively.

To return to the previous screen, press the **Exit** soft key.

You can also deactivate all call waiting settings by selecting the **Cancel All** option.

Network Selection

The Network Selection feature enables you to automatically or manually select the network used when roaming outside of your home area.

Note: You can select a network other than your home network only if there is a valid roaming agreement between them.

To indicate to automatically or manually select the network when roaming:

1. When **Network Selection** displays, press the **Select** soft key.
2. Press the Up or Down key until the appropriate option highlights, then press the **OK** soft key or **X** key.

If you select **Automatic**, you are connected to the first available network when roaming.

If you select **Manual**, the phone scans for the available networks. Go to Step 3.

3. Press the Up or Down key until the network you want highlights and then press the **OK** soft key or **X** key.

You are connected to that network.

Caller ID

You can prevent your phone number from being displayed on the phone of the person being called.

Note: Some networks do not allow you to change this setting.

The following options are available:

Default: the default setting provided by the network is used.

Hide Number: your number does not display on the other person's phone.

Send Number: your number is sent each time you make a call.

Closed User Group (CUG)

This network service allows incoming and outgoing calls to be restricted to a selected user group. You can create up to ten user groups.

Note: This option must be supported by your carrier and subscription is required.

For details on how to create and use a closed user group, contact your service provider.

Example: A company lends SIM cards to its employees and wants to restrict outgoing calls to members of the same team.

Activating a Closed User Group

If you select the **Closed User Group** menu, you can enter the CUG function. You can now access the following options after pressing the **Select** soft key or **X** key:

Index List: lets you list, add or delete CUG index numbers. The list of current CUG indexes appears. Add a new CUG index as advised by your service provider or delete a selected group.

To	Press the
scroll through the existing CUG indexes	Up or Down key.
add a new CUG index	Options soft key, select the Add option and enter the index.
delete a CUG index	Options soft key and select the Delete option.
activate a CUG index	Options soft key and select the Activate option.

Outside Access: lets you enable or disable calls to numbers other than those in the Closed User Group. This feature depends on the nature of your CUG subscription. Please check with your service provider.

Default Group: you may set a default CUG with your service provider. If you have done so, you can enable the **Default Group** option on your phone. When making a call, you are given the option of using your default CUG, instead of selecting one from the list.

Deactivate: deactivates the CUG function. This option appears only when the default group is enabled or a CUG index is selected.

Games

You can download MIDlets (Java applications that run on mobile phones) from various sources using the WAP Browser, and store them in your phone.

When you access the **Games** menu, the list of the default games appears. Once you have downloaded games, they are added to the list.

Note: Java services may not be available, depending upon your service provider.

Downloading a new game

You can download more games from the web site preset by your service provider using the **Shop Games** option.

Launching a MIDlet

Note: The procedure explained below is for the default games. For downloaded games, the procedure may be different.

1. Scroll to the MIDlet you want on the Games list and press the **Launch** soft key or **X** key.
2. On the startup screen of the MIDlet, scroll to an option using the Navigation keys.

The following options are available:

START GAME: starts a new game.



CONTINUE: allows you to continue the last game you played.

HIGH SCORE: shows the high score table. This option may not be available for some games.

HOW TO PLAY: shows how to play the game and the key functions for the game.

OPTION: allows you to switch the game sound on or off.

3. Press the  key to confirm your selection.

While you are playing a game, to	Press the
adjust the sound volume	Volume keys.
stop the game and return to the startup screen	 key.
exit the game	 key.

Using the game options

You can access the following options by pressing the **Options** soft key on the Games list.

Delete: allows you to delete the currently selected MIDlet. When you select the default games from the list, this option is not available.

Delete all: allows you to delete all of the MIDlets you downloaded from the wireless web. When you select the default games from the list, this option is not available.

Properties: shows you information about the currently selected MIDlet, such as the file size, application version, and its vendor.

Memory status: shows you the Total, Free, and Used memory, and also number of games you downloaded.

Entering Text

If you need to enter text while using a MIDlet, you can use the following input modes:

Upper-case character mode (A): allows you to enter upper-case English characters.

Lower-case character mode (a): allows you to enter lower-case English characters.

Number mode (1): allows you to enter numbers.

Symbol mode: allows you to enter symbols. After highlighting a symbol by pressing the Navigation keys, press the  key to insert it.

T9 mode (T9): allows you to enter English characters by pressing one key per letter.

To change the text input mode, press the  key until the appropriate indicator appears on the soft key area of the display.

MEdia Mall

The MEdia Mall menu provides the following options:

- ◆ Shop Ringtones
- ◆ Shop Games
- ◆ Shop Graphics
- ◆ Shop Multimedia
- ◆ Shop Applications
- ◆ MEdia Home

Shop Ringtones

Selecting this menu option launches the web browser to the Download Center menu.

1. Use the **Select** soft key to choose the option.
2. Use the Up and Down navigation keys to move to your desired option and press the **Select** soft key.
3. Continue to navigate through the menu options.

Note: Additional charges may incur when downloading ringtones. Contact your service provider for further information.

Shop Games

Selecting this menu option launches the web browser to the Cingular's Arcade menu.

1. Use the **Select** soft key to choose the option.
2. Use the Up and Down navigation keys to move to your desired option and press the **Select** soft key.
3. Continue to navigate through the menu options.

Note: Additional charges may incur when downloading games. Contact your service provider for further information.

Shop Graphics

Selecting this menu option launches the web browser to the Download Center menu.

1. Use the **Select** soft key to choose the option.
2. Use the Up and Down navigation keys to move to your desired option and press the **Select** soft key.
3. Continue to navigate through the menu options.

Note: Additional charges may incur when downloading graphics. Contact your service provider for further information.

Shop Multimedia

Selecting this menu option launches the Shop Multimedia Store menu.

1. Use the **Select** soft key to choose the option.
2. Use the Up and Down navigation keys to move to your desired option and press the **Select** soft key.
3. Continue to navigate through the menu options.

Note: Additional charges may incur when downloading items. Contact your service provider for further information.

Shop Applications

Selecting this menu option launches the web browser to the games menu.

1. Use the Up and Down navigation keys to move to your selection and press the **Options** soft key. Press the

Select soft key to continue or **Back** to make another selection.

2. Use the Up and Down navigation keys to move to your desired option and press the **Select** soft key.
3. Continue to navigate through the menu options.

MEdia Home

Selecting this menu option launches the Cingular menu.

1. Use the **Select** soft key to choose the option.
2. Use the Up and Down navigation keys to move to your desired option and press the **Select** soft key.
3. Continue to navigate through the menu options.

Note: Additional charges may incur when downloading items. Contact your service provider for further information.

Sound Settings

You can use the Sound Settings feature to customize various settings, such as the:

- ring melody, volume and type.
- sounds made when you press a key, receive a message, or switch your phone on/off.
- alert tone made every minute during a call, when you make an error or when your call is connected to the system.

Note: When the phone is in Silent mode, you cannot change the sound settings.

Ring Tone

This menu allows you to select a ring melody.

You can choose between many different melodies. Each time you select a melody, it plays continuously until you make a selection or exit the option. If you have downloaded sounds from the Internet, you can use them in this menu.

Ring Volume

This menu allows you to adjust the ring volume to one of five levels.

Use the Up and Down keys or the Volume keys on the left side of the phone to increase or decrease the volume.

Shop Ringtones

This option opens the WAP browser to a web site where you can download additional ringtones.

Alert Type

This menu allows you to specify how you are to be informed of incoming calls.

The following options are available:

Melody: the phone rings using the ring melody selected in the **Ring Tone** menu (**Menu 6.1**).

Vibration: the phone vibrates but does not ring.

Vibra+Melody: the phone first vibrates three times and then starts ringing.

Keypad Tone

This menu allows you to select the tone that the phone sounds when you press a key. The options are **Off**, **Cool**, **Piano**, **Tone** and **Beep**.

To turn off the sound, select **Off**.

Message Tone

This menu allows you to select how the phone informs you that a new message has been received.

SMS Tone

The following options are available for alerting you to new SMS messages:

SMS Tone x: the phone uses one of several SMS tones.

Off: the phone does not use the SMS tone.

Vibration: the phone vibrates.

Single Beep: the phone beeps once.

SMS-CB Tone

The following options are available for alerting you to new SMS-CB messages:

Off: the phone does not use the SMS-CB tone.

Vibration: the phone vibrates.

Single Beep: the phone beeps once.

SMS-CB Tone x: the phone uses one of several SMS-CB tones.

MMS Tone

The following options are available for alerting you to new multimedia messages:

MMS Tone x: the phone uses one of several MMS tones.

Off: the phone does not use the MMS tone.

Vibration: the phone vibrates.

Single Beep: the phone beeps once.

Alert on Call

This menu option allows you to turn off the following alerts during a call:

- Alarm
- Text messages
- MMS
- SMS
- Low Battery
- WAP Push

The default setting is **On**. To turn off this setting, select the **Off** setting and press the **Select** soft key.

Power On/Off

This menu allows you to select the melody that the phone sounds when it is switched on and off.

To turn the sound off, select **Off**.

Extra Tones

You can customize additional tones used for the phone.

To turn a given tone	Press the
on	On soft key or ✕ key. A check mark displays in front of the option.
off	Off soft key or ✕ key. The check mark no longer displays.

The following options are available:

Error Tone: sets whether or not the phone informs you when you have make a mistake.

Minute Minder: sets whether or not the phone beeps every minute during an outgoing call to keep you informed of the length of your call.

Connect Tone: sets your phone to beep when your call is connected to the system.

Applications

The Applications menu enables you to:

- ◆ set the alarm so that the phone rings at a specific time, such as to remind you of an appointment.
- ◆ view the calendar and organize your schedule.
- ◆ set the current date and time.
- ◆ use the phone as a calculator for basic mathematical equations or currency exchange operations.
- ◆ define a list of things to do.
- ◆ create personal voice memo's.
- ◆ identify currency exchange rates

Alarm

This feature allows you to:

- ◆ set the alarm to ring at a specific time.
- ◆ set the phone to switch on automatically and ring the alarm even if the phone is switched off.

The following options are available:

Once Alarm: the alarm rings only once and is then deactivated.

Daily Alarm: the alarm rings every day at the same time.

Wake-up Call: the alarm rings to wake you up in the morning.

To set the alarm:

1. Choose the type of alarm to be set and press the **Select** soft key or **X** key.
2. Enter the time for the alarm to sound.

If you want to use the alarm options, press the **Options** soft key. The following options are available:



Remove Alarm: deactivates the current alarm.

Alarm Tone: allows you to select an alarm melody.

3. Press the **OK** soft key.
4. Choose **AM** or **PM** using the Up and Down keys and press the **Select** soft key or **X** key.

Note: Your phone is preset to use 12-hour format. To change the time format, see page 134.

5. If you select **Wake-up Call** in step 1, select the repeat option, **Monday to Friday** or **Monday to Saturday** and press the **Select** soft key or **X** key.

To stop the alarm when it rings press the **Exit** soft key, Volume keys, C key,  key, or  key.

Remove Alarm: deactivates all alarm settings.

Autopower: when this option is set to **Enable**, the alarm rings at the specified time, even if the phone is switched off.

If the option is set to **Disable** and the phone is switched off at the specified time, the alarm does not ring.

Calendar

With the Calendar feature, you can:

- ◆ consult the calendar.
- ◆ write memos to keep track of your schedule.
- ◆ set an alarm to act as a reminder, if necessary.

Consulting the Calendar

When you select the **Calendar** menu (**Menu 7.2**), the calendar displays with today's date highlighted. The

following options are available when you press the

Options soft key:

Search All: displays all memos set, starting with the oldest, regardless of the day. To scroll through the memos, press the Up or Down key.

Delete All: allows you to delete all of the memos. You are asked to confirm your action.

Go to Date: allows you to jump to a specific date.

Exit: exits the Calendar feature and returns to Idle mode.

Writing a Memo

To write or edit a memo on a specific date:

1. Select a date on the calendar, using the Navigation keys.

Note: To skip to the previous or next month, press the Volume keys on the left side of the phone.

2. Press the **X** key.

An empty memo screen displays to allow you to enter your memo.

3. Enter your memo and then press the **OK** soft key or **X** key.

Note: For further details about how to enter characters, see page 51.



You are asked if you wish to set an alarm.

4. If you want the alarm to ring on the chosen day, press the **Yes** soft key or **X** key.

Otherwise, press the **No** soft key. The memo is saved and the display returns to the calendar.

5. If you pressed the **Yes** soft key or **X** key, set the time for the alarm and press the **OK** soft key or **X** key.

Note:

- Your phone is preset to a 12-hour format. To change the time format, see page 134.
- When the alarm time you set goes off and the alarm rings. To view details about the memo, press the **View** soft key. To stop the alarm, press the **Exit** soft key, **C** key,  key, or  key.

You can also select the melody for the alarm by pressing the **Melody** soft key.

6. Select either **AM** or **PM** and press the **Select** soft key or **X** key.

The color of the date on the calendar changes to green to indicate that a memo exists for that date.

Viewing a memo

When you select a day on which more than one memo exists, the latest memo for the day displays.

In that case, press the Up or Down key to scroll to the previous or next memo.

You can access the following options by pressing the **Options** soft key or **X** key:

New: allows you to add a new memo.

Edit: allows you to change the memo text.

Alarm: allows you to set the alarm to ring at the specified time to remind you of the memo. If you have already set an alarm for that memo, you can change or delete the alarm.

Delete: deletes the memo.

Copy to: allows you to copy the memo to another date or time.

Move to: allows you to change the time or date of the memo.

Time & Date

This menu allows you to change the current time and date displayed. You can also check the current time for 22 major cities around the world.

The following options are available:

Set Time: allows you to enter the current time. You can choose the time format in the **Time Format** menu (**Menu 7.3.4**).

Note: Before setting the time, you must specify your time zone in the **World Time** menu (**Menu 7.3.3**).

Set Date: allows you to enter the month, day and year.

World Time: allows you to find out what time it is another part of world, using the Left and Right keys.

The screen shows the:

- city name.
- time difference between the selected city and your city if you have set the local time (see below for further details).
- current date and time.
- city selected as your time zone.

To select your time zone:

1. Select the city corresponding to your time zone by pressing the Left or Right key one or more times. The local date and time display.
2. Press the **Set** soft key.

Time Format: allows you to change the time format to **24 Hours** or **12 Hours**.

Auto Update: allows you to use the service providers network time and date. You can choose from Off, On, and Confirm First.

Calculator

With this feature, you can use the phone as a calculator. The calculator provides the basic arithmetic functions; addition, subtraction, multiplication and division.

1. Enter the first number using the numeric keys.

Note: To include a decimal point or a bracket, press the left soft key until the symbol you want displays.

2. Press the right soft key until the symbol you want displays: + (addition), - (subtraction), * (multiplication), / (division).

3. Enter the second number.

4. To view the result, press the  key.

5. Repeat steps 1 to 4 as many times as required.

To Do List

This feature allows you to:

- ◆ enter a list of tasks to be done.
- ◆ assign a priority and a deadline to each task.
- ◆ sort the tasks by priority and status mark.

Creating the To Do List

1. Press the **New** soft key or  key.

2. Enter the first task.

Note: For further details about how to enter characters, see page 51.



3. Press the **OK** soft key or **✕** key.

4. Select a priority level of high, normal, or low priority using the Up or Down key and press the **Select** soft key or **✕** key.

5. Enter your deadline and press the **OK** soft key or **✕** key.

If you do not want to set a deadline, press the **Skip** soft key.

Editing the To Do List

When you select the **To Do List** menu, the current contents display with a status mark, if the task has been done, and priority;  for High,  for Normal and  for Low.

To view the details for a task, select it from the list. You can scroll to other task by pressing the Up or Down key.

To change the status of a task, press the * key to mark the task as completed as of the current time and date.

By pressing the **Options** soft key or **✕** key on the list or the task view, you can access the following options:

New: allows you to create a new task.

Mark: allows you to change the status of the current task to either **Done** or **Undo**.

Edit: allows you to change the text, priority, and/or deadline for the current task.

Sort: allows you to sort the existing tasks by priority of status. Select the sort criteria, **High**, **Low**, **Done**, or **Undo**.

Copy: makes a copy of the current task.

Copy to calendar: allows you to copy the current task as a calendar memo. You can change the text and deadline for the task, and set the alarm.

Delete: deletes the current task.

Delete all: allows you to delete all of the tasks.

Exit: exits the To do list.

Action	Procedure
View the details for a specific task	<ol style="list-style-type: none"><li data-bbox="433 528 757 566">1. Highlight the task.<li data-bbox="433 597 837 674">2. Press the Options soft key.<li data-bbox="433 705 845 828">3. Scroll through the tasks using the Up and Down keys.

Action	Procedure (Continued)
Change the status of a specific task	<ol style="list-style-type: none"> 1. Highlight the task. 2. Press the * key to mark the task as completed as of the current date and time. <p style="text-align: center;"><u>Or</u></p> <ol style="list-style-type: none"> 1. Highlight the task. 2. Press the Options soft key. 3. Select the Mark option. 4. Select the appropriate status (Done or Undo).
Create a new task	<ol style="list-style-type: none"> 1. Press the Options soft key. 2. Select the New option. 3. Enter text, priority and deadline for the task.

Action	Procedure (Continued)
Edit an existing task	<ol style="list-style-type: none"> 1. Highlight the task. 2. Press the Options soft key. 3. Select the Edit option. 4. Change the text, priority and/or deadline for the task.
Sort the existing tasks by priority or status	<ol style="list-style-type: none"> 1. Press the Options soft key. 2. Select the Sort option. 3. Select the sort criterion (High, Low, Done or Undo).
Copy a task	<ol style="list-style-type: none"> 1. Highlight the task. 2. Press the Options soft key. 3. Select the Copy option. 4. Change the text, priority and/or deadline for the task.

Action	Procedure (Continued)
Copy a task to the calendar	<ol style="list-style-type: none"> 1. Highlight the task. 2. Press the Options soft key. 3. Select the Copy to Calendar option. 4. Change the text and/or deadline for the task and set the alarm.
Delete a task	<ol style="list-style-type: none"> 1. Highlight the task. 2. Press the Options soft key. 3. Select the Delete option.
Delete all tasks	<ol style="list-style-type: none"> 1. Press the Options soft key. 2. Select the Delete All option. 3. Confirm the deletion by pressing the OK soft key.
Exit the To Do list	<ol style="list-style-type: none"> 1. Press the Options soft key. 2. Select the Exit option.

Voice Memo

The voice memo menu allows you to record voice memo's for easy retrieval at a later time.

The following options are available:

- ◆ Record
- ◆ Memo List
- ◆ Delete All
- ◆ Memory Status

Record

This menu allows you to record a new memo. When you select this option, the display shows a 30-second timer.

1. To start recording, press the **Record** soft key or **X** key.
2. Record a memo by speaking into the microphone.
3. When you press the **Stop** soft key or **X** key, or if the recording time expires, the following options display:

Replay: plays back your memo.

Re-Record: discards the memo and enables you to record another one.

Save: allows you to save the memo.

Quit: cancels your recording and exits the Record menu.

4. To save the memo, choose **Save** and press the **Select** soft key or **X** key.
5. Press the **C** key to clear the default name, if necessary, and enter a name for the memo.

For further details about how to enter characters, see page 51.

6. Press the **OK** soft key or **X** key.

The memo is saved and then the display shows the memo information.

7. Press the **Options** soft key or **X** key to access the following memo options:

Send: allows you to send the memo to other people by using the MMS feature. Follow the procedure on page 79.

Rename: allows you to change the memo's name.

Delete: allows you to delete the memo.

8. To exit, press the **Back** soft key or **End Call** key.

Memo list

This menu shows a list of saved voice memos. Scroll to a memo and press the **Options** soft key or **X** key. The following options are available:

Play: plays the memo.

Send: allows you to send the memo to other people by using the MMS feature. See page 80 for further details about sending a message.

Rename: allows you to change the memo's name.

Information: displays information about the memo, such as the name, the date when the memo was made, recording durations, and memory size.

Delete: allows you to delete the memo.

Delete all

In this menu, you can delete all of your voice memos.

When the confirmation message appears, press the **Yes** soft key or **X** key. To cancel the deletion, press the **No** soft key.

Memory status

You can check the amount of memory being used and the memory remaining for voice memos.

The display shows the total, free, and used memory including the number of memos you recorded and the total number of the memos you can record.

Currency Exchange

Using this menu, you can figure currency conversions.

1. Enter the current exchange rate of your source currency and press the **OK** soft key.

You can insert a decimal point by pressing the **#** key.

2. Enter the amount to convert and press the **OK** soft key.

The amount you entered and its equivalent value display.

3. Press the **↶** soft key to exit the currency converter.

My MEdia

The My MEdia menu option is used to access the internet and the following available options listed.

MEdia Net



Your phone is equipped with a WAP (Wireless Application Protocol) browser to allow you to access and navigate the Wireless Web using your phone.

Home



Selecting this menu connects the phone to the network and loads the homepage of the Wireless Web service provider. You can also press the  key in Idle mode. The content of the WAP Browser startup homepage depends on your Wireless Web service provider. To scroll through the screen, use the Up and Down keys.

Note: To access the startup homepage from any other screen in the WAP Browser, use the **Home** option.

Exiting the WAP Browser

To exit the browser at any time, simply press the  key or press and hold the  key.

Navigating the WAP Browser

To	Press the
scroll through and select browser items	Up or Down key and then press the OK soft key or  key to confirm the selection.
select a numbered item	corresponding numeric key.
return to the previous page	Back soft key or the  key.
return to the startup homepage	* key and select the Home menu. For further details about this option, see page 145.

Entering Text in the WAP Browser

When you are prompted to enter text, the current text input mode is indicated on the screen.

The following modes are available:

Upper-case character (A): allows you to enter upper-case English characters.

Lower-case character (a): allows you to enter lower-case English characters.

Symbols:  allows you to enter symbols in upper or lower-case character mode.

Number (1): allows you to enter numbers.

To change the text input mode	Press the X key one or more times.
To enter a space	Press the # key.
To edit text	<ol style="list-style-type: none"> 1. Set the cursor to the right of the character(s) to be corrected. 2. Press the  key as required. 3. Enter the correct character(s).

Selecting and Using Menu Options

Various menus are available when you are using the WAP Browser to navigate the Wireless Web.

To access a menu option:

1. Press and hold down the ***** key.
A menu displays.
2. Highlight a menu by pressing the Up and Down keys.
3. Select the option by pressing the **Select** soft key or **X** key.
4. If necessary, select a secondary option using the Up and Down keys, and press the **Select** soft key or **X** key to confirm.

Note: The menus may vary, depending on your version of the WAP Browser.

The following options are available:

Reload: reloads the current page.

Home: takes you back at any time to the homepage of the Wireless Web service provider.

Goto URL: allows you to manually enter the URL address of a Web page. After entering an address, press the **OK** soft key or **X** key to go there directly.

Show URL: displays the URL address of the site to which you are currently connected. It also enables you to declare the current site as the startup homepage.

To	Press the
declare the current page as your startup homepage	Option soft key or X key, select the Save to Home option and press the Select soft key.
set a bookmark for the current page	Option soft key or X key, select the Save to Bookmark option and press the Select soft key.
cancel your setting	Back soft key.

Edit Home: allows you to change the startup homepage manually. Enter the required URL and press the **OK** soft key or **X** key. For more information about entering text, see page 51.

Favorite

This menu allows you to store the URL addresses of your favorite web sites. You can access this menu directly by pressing and holding down the # key while using the WAP Browser.

To store a URL address:

1. Select an empty location and press the **Options** soft key or **X** key.
2. Enter the address and press the **Enter** soft key or **X** key.

Note: For further details about how to enter characters, see “Entering Text” on page 51.

3. Enter a name for the favorite item and press the **Enter** soft key.

After saving favorite items, you can use the following options by pressing the Options soft key or **X** key:

Goto URL: takes you to the site.

Edit: allows you to edit the address.

Delete: deletes the address.

http://

This menu allows you to manually enter the URL address of the web site that you wish to access. You can access this menu directly by pressing and holding the * key in the WAP browser.

For further details about entering characters, see “Entering Text” on page 51.

Settings

This option allows you to set up five proxy servers for the WAP browser. Contact your service provider for details.

For each server, the following options are available:

Profile Name: enter a name that you wish to assign to the HTTP proxy server.

Homepage URL: set the address of your startup homepage. When the default homepage displays, you can delete it using the  key and enter your own choice.

Security: set the data transmission mode. Choose **Secure** to protect your data against unauthorized access; otherwise, choose **Non-Secure**.

Bearer: select the bearer to be used for each type of network address accessed: **GPRS** or **Data**. The remaining options depend on the Bearer setting.

When the bearer is set to **GPRS**:

IP Address: enter the WAP gateway address required to connect to the Internet.

User Name: enter the User ID required to connect to the GPRS network.

Password: enter the password required to connect to the GPRS network.

APN: enter the access point name used for the address of the GPRS network gateway.

When the bearer is set to Data

Login Name: enter the PPP server login ID.

Password: enter the PPP server password.

Dial-up Number: enter the PPP server phone number.

Data Call Type: select a data call type: Analog or ISDN.

IP Address: enter the WAP gateway address required to connect to the Internet.

Note: The WAP Browser settings may vary, depending on the service provider. Contact your service provider for further information.

Clear Cache

You can clear the information stored in the cache, which is the phone's temporary memory which stores the most recently accessed Web pages.

Press the **Yes** soft key or **X** key to confirm the deletion. Otherwise, press the **No** soft key.

Audio

In this menu, you can view the list of sounds downloaded from the web server or received in multimedia messages. You can set the downloaded sounds as the current ring tone or send them to other phones.

Scroll to the sound you want to listen to and press the **Play** soft key or **X** key.

By pressing the **Options** soft key or **X** key, you can access the following options:

Rename: allows you to change the name of the sound.

Delete: allows you to delete the sound.

Set as Ring Tone: sets the sound as your ring tone.

Using the **Shop Ringtones** option on the Audio list, you can access the web site preset by your service provider and download new sounds.

Graphics

In this menu, you can view the list of images downloaded from the web server or received in messages. You can set

the downloaded image as the current background image or send them to other phones.

Scroll to the image you want to view and press the **View** soft key or **X** key.

Press the **Options** soft key or **X** key to access the following options:

Rename: allows you to change the name of the image.

Delete: allows you to delete the image.

Set as Wallpaper: sets the image as your wallpaper for the idle screen.

Using the **Shop Graphics** option on the Graphics list, you can access the web site preset by your service provider and download new images.

Delete All

To delete previously downloaded Ringtones and Graphics, select from the following options:

- ◆ All
- ◆ Audio
- ◆ Graphics.

This menu allows you to delete all of the downloaded items in the Audio and Graphics folders separately. You can delete all of the items at one time.

To	Press the
select a folder to clear	Up or Down key. To delete all of your items, select All .
place or remove a check mark	X key.
delete the marked items	Delete soft key.

When a confirmation message displays, press the **Yes** soft key or **X** key to confirm.

Memory Status

You can check the amount of the memory being used and the memory remaining for the Audio or Graphics menu.

The display shows the total, used, and, free space, including each space used for sounds and images.

Phone Settings

Many different features of your phone can be customized to suit your preferences. All of these features are accessed in the **Phone Settings** menu.

Display Settings

You can change the background image and the display style for Menu mode according to your preference.

Wallpaper

This option allows you to change the background image to be displayed in Idle mode.

To change the background image:

1. Use the Up or Down key to select the image you want, then press the **Select** soft key or **X** key.

You have various preset images available. You can also select any downloaded images.

2. When the image displays, press the **Select** soft key or **X** key.

To choose to display text on the screen, select the **Text Display** option. You can specify whether or not the phone displays the time and date on the idle screen.

3. To choose the color of the text select the **Text Color** option and select the color of the text to be displayed on the idle screen.

Menu Style

This menu allows you to select the menu display style. You can choose either **Grid Style**, **Bar Style** or **Page Style**.

Shop Graphics

This menu allows you to access the web site preset by your service provider to download images.

Once you have downloaded images, they are saved in the **Graphics** folder (**Menu 8.3**).

Auto Key Lock

You can set the phone to automatically lock the keys if no key is pressed within a given amount of time. This feature is useful to avoid pressing keys by mistake.

To use this feature, select the length of time for which the phone waits before it locks the keypad.

Contrast

This menu allows you to adjust the contrast of the display screen to see it better in different lighting conditions.

Adjust the contrast by using the navigation keys or the ▲ and ▼ keys on the left side of the phone.

Back Light

You can select the length of time the phone uses the backlight. Select the length of time for which the backlight is on. The backlight turns on when you press a key or receive a call or message and remains on for the specified length of time.

Graphic Logo

This menu allows you to display your service provider's logo instead of its name.

Off: the service provider's name displays in Idle mode.

On: the service provider's logo displays in Idle mode; if no logo has been stored, the service provider's name displays.

Greeting Message

This menu allows you to set a greeting to be displayed briefly when the phone is switched on.

To	Press the
clear the existing message	C key and hold it down until the message is cleared.
enter a new message	appropriate alphanumeric keys.
change the text input mode	Right soft key.

Own Number

This function is a memory aid, which you can use to check your own phone number if necessary.

You can:

- ◆ assign a name to each of the own phone numbers registered on your SIM card.
- ◆ edit the names and numbers.

Any changes made here do not in any affect the actual subscriber numbers on your SIM card.

Language

You can select a display language. When the language option is set to **Automatic**, the language is automatically selected according to the language of the SIM card used.

Security

The Security feature enables you to restrict the use of your phone to the people and the types of calls of your choice. Various codes and passwords are used to protect the features of your phone. They are described in the following sections.

PIN Check

When the PIN Check feature is enabled, you must enter your PIN each time you switch the phone on.

Note: If the PIN number is entered incorrectly 3-times, you must contact your service provider for your PUK key. If the PUK key is entered incorrectly 3-times, you must return your phone to the service provider.

Consequently, any person who does not have your PIN cannot use your phone without your approval.

Note: Before disabling the PIN Check feature, you must enter your PIN.

The following options are available:

Disable: the phone connects directly to the network when you switch it on.

Enable: you must enter the PIN each time the phone is switched on.

Change PIN

This feature allows you to change your current PIN, provided that the PIN Check feature is enabled. You must enter the current PIN before you can specify a new one. Once you have entered a new PIN, you are asked to confirm it by entering it again.

Phone Lock

When the Phone Lock feature is enabled, the phone is locked and you must enter the 8-digit phone password each time the phone is switched on.

The password is preset to “00000000” at the factory. To change the phone password, see the **Change Password** menu.

Once the correct password has been entered, you can use the phone until you switch it off.

The following options are available:

Disable: you are not asked to enter the phone password when you switch the phone on.

Enable: you are required to enter the phone password when you switch the phone on.

Change Password

The Change Password feature allows you to change your current phone password to a new one. You must enter the current password before you can specify a new one.

The password is preset to “00000000” at the factory. Once you have entered a new password, you are asked to confirm it by entering it again.

Privacy

Using this menu, you can lock your media contents, such as multimedia messages, memo list, graphics and audio. Once you have locked the contents, you must enter the phone's password to access the associated menus.

To	Press the
select an item to lock	Up or Down key. To lock all of the contents, selects All
place or remove a check mark	X key
lock the marked items	OK soft key.

When the phone asks for the password, enter the password and press the **OK** soft key or **X** key.

Note: The password is preset to "00000000" at the factory. To change this password, see page 157.

SIM Lock

When the SIM Lock feature is enabled, your phone only works with the current SIM. You must enter the SIM lock code to unlock the SIM so you can use a different SIM card.

Once you have entered the lock code, you are asked to confirm your entry.

FDN Mode

FDN (Fixed Dial Number) mode, if supported by your SIM card, allows you to restrict your outgoing calls to a limited set of phone numbers.

The following options are available:

Disable: you can phone any number.

Enable: you can only call phone numbers stored in Phone Book. You must enter your PIN2.

Note: Not all SIM cards have a PIN2. If your SIM card does not, this menu does not display.

Change PIN2

The Change PIN2 feature allows you to change your current PIN2 to a new one. You must enter the current PIN2 before you can specify a new one. Once you have entered a new PIN2, you are asked to confirm it by entering it again.

Note: Not all SIM cards have a PIN2. If your SIM card does not, this menu does not display.

Extra Settings

You can turn the automatic redialing or answering features on or off.



To turn a feature	Press the
on	On soft key or X key. A check mark displays in front of the option.

To turn a feature	Press the
off	Off soft key or  key. The check mark no longer displays.

The following options are available:

Auto Redial: when this option is checked, the phone makes up to ten attempts to redial a phone number after an unsuccessful call.

Note: The interval between two call attempts varies.

Anykey Answer: when this option is checked, you can answer an incoming call by pressing any key, except the  key and the **Reject** soft key. To reject the call, press the  key or the **Reject** soft key.

When this option is unchecked, you can only press the  key or **Accept** soft key.

Short Cut

The Navigation keys can be used as shortcut keys. In Idle mode, they allow you to access specific menus directly.

To assign a shortcut to a key:

1. Select the key to be used as a shortcut key by pressing the Up or Down key, and press the **Select** soft key.

- Key Up
- Key Down
- Key Right
- Key Left

2. Select the menu to be assigned to the key by pressing the Up or Down key.

Note: To deactivate a shortcut key, select the **None** option.

3. Press the **Select** soft key or **X** key to save the selection.

Reset Settings

You can easily reset your phone to its default settings. To reset your phone:

1. Select the **Reset Settings** menu.
2. Enter the 8-digit password and press the **OK** soft key.

Note: The password is preset to "00000000." To change this password, see page 157.

TTY Settings

Note: The TTY option is not viewable but can be accessed by entering 9 on the keypad from this menu.

TTY (also known as a TDD or Text Telephone) is a telecommunications device that allows people who are deaf or hard of hearing, or who have speech or language disabilities, to communicate via a telephone.

Your phone is compatible with select TTY devices which have an internal CTM. Please check with the manufacturer of your TTY device for connectivity information and to ensure that the TTY device supports digital wireless transmission.

Use the following steps to access the TTY settings:

1. From the menu screen select Phone Settings (**Menu 9**).
2. Press the **9** key to access this function.
3. Enter 4-T-T-Y or (4889) in the password field and press the **OK** soft key.

The following options are available:

Enable: CTM is active and TTY is available for use.

Disable: CTM is not available for use.

Note: For additional technical support you may access the following website or call 1-888-987-4357.

http://www.samsungtelecom.com/contact_us/accessibility.asp

Solving Problems

If you are experiencing problems with your phone, perform the following simple checks before contacting a service professional. This may save you the time and expense of an unnecessary service call.

When you switch your phone on, the following messages may appear

Insert SIM Card

- ◆ Check that the SIM card is correctly installed.

Phone Locked Enter Password

- ◆ The automatic locking function has been enabled. You must enter the phone's password before you can use the phone.

Enter PIN

- ◆ You are using your phone for the first time. You must enter the Personal Identification Number supplied with the SIM card.
- ◆ The PIN Check feature is enabled. Every time the phone is switched on, the PIN has to be entered. To disable this feature, use the **PIN Check** menu.

Enter PUK

- ◆ The PIN code was entered incorrectly three times in succession and the phone is now blocked. Enter the PUK supplied by your service provider.

“No service,” “Network failure” or “Not done” displays

- ◆ The network connection was lost. You may be in a weak signal area (in a tunnel or surrounded by buildings). Move and try again.
- ◆ You are trying to access an option for which you have not taken out a subscription with your service provider. Contact the service provider for further details.

You have entered a number but it was not dialed

- ◆ Have you pressed the  key?
- ◆ Are you accessing the right cellular network?
- ◆ You may have set an outgoing call barring option.

Your correspondent cannot reach you

- ◆ Is your phone switched on (the  key pressed for more than one second)?
- ◆ Are you accessing the right cellular network?
- ◆ You may have set an incoming call barring option.

Your correspondent cannot hear you speaking

- ◆ Have you switched off the microphone?
- ◆ Are you holding the phone close enough to your mouth?
The microphone is located at the bottom of the phone.

The phone starts beeping and “Warning** Low Battery” flashes on the display**

- ◆ The battery is insufficiently charged. Recharge the battery.

The audio quality of the call is poor

- ◆ Check the signal strength indicator on the display (); the number of bars indicates the signal strength from strong () to weak ().
- ◆ Try moving the phone slightly or moving closer to a window if you are in a building.

No number is dialed when you recall a Phone Book entry

- ◆ Check that the number has been stored correctly, by using the Phone Book Search feature.
- ◆ Re-store the number, if necessary.

If the above guidelines do not help you to solve the problem, take a note of:

- the model and serial numbers of your phone
- your warranty details
- a clear description of the problem

Then contact your local dealer or Samsung after-sales service.

Access Codes

There are several access codes that are used by your phone and its SIM card. These codes help you protect the phone against unauthorized use.

When requested for any of the codes explained below, enter the appropriate code (displayed as asterisks) and press the OK soft key or ✕ key. If you make a mistake, press the  key until the incorrect digit is cleared and then continue entering the correct code.

The access codes, except for the PUK and PUK2 codes can be changed using the Security menu. See “Security” on page 156 for further details.

Important! Avoid using access codes resembling emergency numbers, such as 911, to prevent accidental dialing of an emergency number.

Phone Password

The Phone Lock feature uses the phone password to protect your phone against unauthorized use. The phone password is supplied with the phone and is preset to “00000000” at the factory.

To	See
activate/deactivate the Phone Lock feature	“Phone Lock” on page 157
change the phone password	“Change Password” on page 157.

PIN

The personal Identification Number or PIN (4 to 8 digits) protects your SIM card against unauthorized use. It is usually supplied with the SIM card.

If you enter an incorrect PIN three times in succession, the code is disabled and cannot be used until you re-enable it by entering the PUK. See below.

To	See
activate/deactivate the PIN Check feature	"PIN Check" on page 156
change the PIN	"Change PIN" on page 157.

PUK

The 8-digit PUK (PIN Unblocking Key) is required to change a disabled PIN. The PUK may be supplied with the SIM card. If not, contact your service provider.

To re-enable your PIN:

1. Enter the PUK and press the **OK** soft key or **X** key.
2. Enter a PIN of your choice and press the **OK** soft key or **X** key.
3. When the **Confirm New PIN** message displays, enter the same code again and press the **OK** soft key or **X** key.

When you enter an incorrect PUK ten times in succession, the SIM card becomes invalid. Contact your service provider for a new card.

PIN2

The PIN2 (4 to 8 digits), supplied with some SIM cards, is required to access specific functions, such as setting the maximum cost of a call. These functions are available if supported by your SIM card.

If you enter an incorrect PIN2 three times in succession, the code is disabled and you cannot access the functions until you re-enable it by entering the PUK2.

PUK2

The 8-digit PUK2 (PIN Unblocking Key 2), supplied with some SIM cards, is required to change a disabled PIN2. If you lose the code, contact your service provider.

To re-enable your PIN2:

1. Enter the PUK2 and press the **OK** soft key or **X** key.
2. Enter a new PIN2 of your choice and press the **OK** soft key or **X** key.
3. When the **Confirm PIN2** message displays, enter the same code again and press the **OK** soft key or **X** key.

When you enter an incorrect PUK2 ten times in succession, you are not able to access the functions requiring the PIN2. Contact your service provider for a new card.

Health and Safety Information

Exposure to Radio Frequency (RF) Signals

Your wireless phone is a radio transmitter and receiver. It is designed and manufactured not to exceed the emission limits for exposure to radio frequency (RF) energy set by the Federal Communications Commission (FCC) of the U.S. Government. These limits are part of comprehensive guidelines and establish permitted levels of RF energy for the general population. The guidelines are based on the safety standards that were developed by independent scientific organizations through periodic and through evaluation of scientific studies.

The standards include a substantial safety margin designed to assure the safety of all persons, regardless of age and health.

The exposure standard for wireless phones employs a unit of measurement known as Specific Absorption Rate (SAR). The SAR limit recommended by the FCC is 1.6W/kg.¹

SAR tests are conducted using standard operating positions specified by the FCC with the phone transmitting at its highest certified power level in all tested frequency

-
1. In the U.S. and Canada, the SAR limit for mobile phones used by the public is 1.6 watts/kg (W/kg) averaged over one gram of tissue. The standard incorporates a substantial margin of safety to give additional protection for the public and to account for any variations in measurements.

bands. Although the SAR is determined at the highest certified power level, the actual SAR level of the phone while operating can be well below the maximum value. This is because the phone is designed to operate at multiple power levels so as to use only the power required to reach the network. In general, the closer you are to a wireless base station antenna, the lower the power output of the phone.

Before a new model phone is available for sale to the public, it must be tested and certified to the FCC that it does not exceed the limit established by the government-adopted requirement for safe exposure. The tests are performed in positions and locations (e.g., at the ear and worn on the body) as required by the FCC for each model. While there may be differences between the SAR levels of various phones and at various positions, they all meet the government requirement.

The FCC has granted an Equipment Authorization for this model phone with all reported SAR levels evaluated as in compliance with the FCC RF exposure guidelines. SAR information on this model phone is on file with the FCC and can be found under the Display Grant section of <http://www.fcc.gov/oet/fccid> after searching on FCC ID printed in the label on the phone.

FCC certification information for this model phone is attached separation paper.

For Body Operation

For body worn operation, this model phone has been tested and meets the FCC RF exposure guidelines when used with a Samsung-supplied or approved accessory designated for this product or when used with and accessory that contains no metal and that positions the handset a minimum from the body.

The minimum distance for this model phone is written in the FCC certification information from the body. None compliance with the above conditions may violate FCC RF exposure guidelines.

For more Information concerning exposure to radio frequency signals, see the following websites:

Federal Communications Commission (FCC)

<http://www.fcc.gov>

Cellular Telecommunications Industry Association (CTIA):

<http://www.wow-com.com>

U.S.Food and Drug Administration (FDA)

<http://www.fda.gov/cdrh/consumer>

World Health Organization (WHO)

<http://www.who.int/peh-emf/en>

Precautions When Using Batteries

- ◆ Never use any charger or battery that is damaged in any way.
- ◆ Use the battery only for its intended purpose.
- ◆ If you use the phone near the network's base station, it uses less power; talk and standby time are greatly affected by the signal strength on the cellular network and the parameters set by the network operator.
- ◆ Battery charging time depends on the remaining battery charge and the type of battery and charger used. The battery can be charged and discharged hundreds of times, but it will gradually wear out. When the operation time (talk time and standby time) is noticeably shorter than normal, it is time to buy a new battery.
- ◆ If left unused, a fully charged battery will discharge itself over time.
- ◆ Use only Samsung-approved batteries and recharge your battery only with Samsung-approved chargers. When a charger is not in use, disconnect it from the power source. Do not leave the battery connected to a charger for more than a week, since overcharging may shorten its life.
- ◆ Extreme temperatures will affect the charging capacity of your battery: it may require cooling or warming first.
- ◆ Do not leave the battery in hot or cold places, such as in a car in summer or winter conditions, as you will reduce the capacity and lifetime of the battery. Always try to keep the battery at room temperature. A phone with a hot or cold battery may temporarily not work, even when the battery is fully charged. Li-ion batteries are particularly affected by temperatures below 0 °C (32 °F).
- ◆ Do not short-circuit the battery. Accidental short-circuiting can occur when a metallic object (coin, clip or pen) causes a direct connection between the + and – terminals of the battery (metal strips on the battery), for example when you carry a spare battery in a pocket or

bag. Short-circuiting the terminals may damage the battery or the object causing the short-circuiting.

- ◆ Dispose of used batteries in accordance with local regulations. Always recycle. Do not dispose of batteries in a fire.

Road Safety

Your wireless phone gives you the powerful ability to communicate by voice, almost anywhere, anytime. But an important responsibility accompanies the benefits of wireless phones, one that every user must uphold.

When driving a car, driving is your first responsibility.

When using your wireless phone behind the wheel of a car, practice good common sense and remember the following tips:

1. Get to know your wireless phone and its features, such as speed dial and redial. If available, these features help you to place your call without taking your attention off the road.
2. When available, use a hands-free device. If possible, add an extra layer of convenience and safety to your wireless phone with one of the many hands-free accessories available today.
3. Position your wireless phone within easy reach. Be able to access your wireless phone without removing your eyes from the road. If you get an incoming call at an inconvenient time, let your voice mail answer it for you.
4. Let the person you are speaking with know you are driving; if necessary, suspend the call in heavy traffic or

hazardous weather conditions. Rain, sleet, snow, ice and even heavy traffic can be hazardous.

5. Do not take notes or look up phone numbers while driving. Jotting down a To Do list or flipping through your phone book takes your attention away from your primary responsibility, driving safely.
6. Dial sensibly and assess the traffic; if possible, place calls when you are not moving or before pulling into traffic. Try to plan calls when your car will be stationary. If you need to make a call while moving, dial only a few numbers, check the road and your mirrors, then continue.
7. Do not engage in stressful or emotional conversations that may be distracting. Make the people with whom you are talking aware that you are driving and suspend conversations that have the potential to divert your attention from the road.
8. Use your wireless phone to call for help. Dial the emergency number in the case of fire, traffic accident or medical emergencies. Remember, it is a free call on your wireless phone!
9. Use your wireless phone to help others in emergencies. If you see a car accident, crime in progress or other serious emergency where lives are in danger, call the emergency number, as you would want others to do for you.
10. If you see a broken-down vehicle posing no serious hazard, a broken traffic signal, a minor traffic accident

where no one appears injured, or a vehicle you know to be stolen, call roadside assistance or any other special non-emergency wireless number.

Operating Environment

Remember to follow any special regulations in force in any area and always switch your phone off whenever it is forbidden to use it, or when it may cause interference or danger.

When connecting the phone or any accessory to another device, read its user's guide for detailed safety instructions. Do not connect incompatible products.

As with other mobile radio transmitting equipment, users are advised that for the satisfactory operation of the equipment and for the safety of personnel, it is recommended that the equipment should only be used in the normal operating position (held to your ear with the antenna pointing over your shoulder).

Electronic Devices

Most modern electronic equipment is shielded from radio frequency (RF) signals. However, certain electronic equipment may not be shielded against the RF signals from your wireless phone. Consult the manufacturer to discuss alternatives.

Pacemakers

Pacemaker manufacturers recommend that a minimum distance of 15 cm (6 inches) be maintained between a wireless phone and a pacemaker to avoid potential interference with the pacemaker. These recommendations

are consistent with the independent research and recommendations of Wireless Technology Research.

Persons with pacemakers:

- ◆ should always keep the phone more than 15 cm (6 inches) from their pacemaker when the phone is switched on.
- ◆ should not carry the phone in a breast pocket.
- ◆ should use the ear opposite the pacemaker to minimize potential interference.

If you have any reason to suspect that interference is taking place, switch your phone off immediately.

Hearing Aids

Some digital wireless phones may interfere with some hearing aids. In the event of such interference, you may wish to consult your hearing aid manufacturer to discuss alternatives.

Other Medical Devices

If you use any other personal medical devices, consult the manufacturer of your device to determine if it is adequately shielded from external RF energy. Your physician may be able to assist you in obtaining this information. Switch your phone off in health care facilities when any regulations posted in these areas instruct you to do so. Hospitals or health care facilities may be using equipment that could be sensitive to external RF energy.

Vehicles

RF signals may affect improperly installed or inadequately shielded electronic systems in motor vehicles. Check with

the manufacturer or its representative regarding your vehicle.

You should also consult the manufacturer of any equipment that has been added to your vehicle.

Posted Facilities

Switch your phone off in any facility where posted notices require you to do so.

Potentially Explosive Environments

Switch your phone off when in any area with a potentially explosive atmosphere and obey all signs and instructions. Sparks in such areas could cause an explosion or fire resulting in bodily injury or even death.

Users are advised to switch the phone off while at a refueling point (service station). Users are reminded of the need to observe restrictions on the use of radio equipment in fuel depots (fuel storage and distribution areas), chemical plants or where blasting operations are in progress.

Areas with a potentially explosive atmosphere are often but not always clearly marked. They include below deck on boats, chemical transfer or storage facilities, vehicles using liquefied petroleum gas (such as propane or butane), areas where the air contains chemicals or particles, such as grain, dust or metal powders, and any other area where you would normally be advised to turn off your vehicle engine.

Emergency Calls

This phone, like any wireless phone, operates using radio signals, wireless and landline networks as well as user-programmed functions, which cannot guarantee

connection in all conditions. Therefore, you should never rely solely on any wireless phone for essential communications (medical emergencies, for example). Remember, to make or receive any calls the phone must be switched on and in a service area with adequate signal strength. Emergency calls may not be possible on all wireless phone networks or when certain network services and/or phone features are in use. Check with local service providers.

To make an emergency call:

1. If the phone is not on, switch it on.
2. Key in the emergency number for your present location (for example, 911 or other official emergency number). Emergency numbers vary by location.
3. Press the  key.

If certain features are in use (call barring, for example), you may first need to deactivate those features before you can make an emergency call. Consult this document and your local cellular service provider.

When making an emergency call, remember to give all the necessary information as accurately as possible.

Remember that your phone may be the only means of communication at the scene of an accident; do not cut off the call until given permission to do so.

Other Important Safety Information

- ◆ Only qualified personnel should service the phone or install the phone in a vehicle. Faulty installation or service may be dangerous and may invalidate any warranty applicable to the device.

- ◆ Check regularly that all wireless phone equipment in your vehicle is mounted and operating properly.
- ◆ Do not store or carry flammable liquids, gases or explosive materials in the same compartment as the phone, its parts or accessories.
- ◆ For vehicles equipped with an air bag, remember that an air bag inflates with great force. Do not place objects, including both installed or portable wireless equipment in the area over the air bag or in the air bag deployment area. If wireless equipment is improperly installed and the air bag inflates, serious injury could result.
- ◆ Switch your phone off before boarding an aircraft. The use of wireless phones in aircraft is illegal and may be dangerous to the aircraft's operation.
- ◆ Failure to observe these instructions may lead to the suspension or denial of telephone services to the offender, or legal action, or both.

Care and Maintenance

Your phone is a product of superior design and craftsmanship and should be treated with care. The suggestions below will help you fulfill any warranty obligations and allow you to enjoy this product for many years

- ◆ Keep the phone and all its parts and accessories out of the reach of small children's.
- ◆ Keep the phone dry. Precipitation, humidity and liquids contain minerals that will corrode electronic circuits.
- ◆ Do not use the phone with a wet hand. Doing so may cause an electric shock to you or damage to the phone.
- ◆ Do not use or store the phone in dusty, dirty areas, as its moving parts may be damaged.
- ◆ Do not store the phone in hot areas. High temperatures can shorten the life of electronic devices, damage batteries, and warp or melt certain plastics.

- ◆ Do not store the phone in cold areas. When the phone warms up to its normal operating temperature, moisture can form inside the phone, which may damage the phone's electronic circuit boards.
- ◆ Do not drop, knock or shake the phone. Rough handling can break internal circuit boards.
- ◆ Do not use harsh chemicals, cleaning solvents or strong detergents to clean the phone. Wipe it with a soft cloth slightly dampened in a mild soap-and-water solution.
- ◆ Do not paint the phone. Paint can clog the device's moving parts and prevent proper operation.
- ◆ Do not put the phone in or on heating devices, such as a microwave oven, a stove or a radiator. The phone may explode when overheated.
- ◆ Use only the supplied or an approved replacement antenna. Unauthorized antennas or modified accessories may damage the phone and violate regulations governing radio devices.
- ◆ If the phone, battery, charger or any accessory is not working properly, take it to your nearest qualified service facility. The personnel there will assist you, and if necessary, arrange for service.

Acknowledging Special Precautions and the FCC and Industry Canada Notice

Cautions

Modifications not expressly approved by the party responsible for compliance could void the user's authority to operate the equipment.

FCC Compliance Information

This device complies with Part 15 of FCC Rules. Operation is subject to the following two conditions:

1. This device may not cause harmful interference, and
2. This device must accept any interference received.

Including interference that may cause undesired operation.

Information to User

This equipment has been tested and found to comply with the limits for a Class B digital device, pursuant to part 15 of the FCC Rules. These limits are designed to provide reasonable protection against harmful interference in a residential installation.

This equipment generates, uses and can radiate radio frequency energy and, if not installed and used in accordance with the instructions, may cause harmful interference to radio communications. However, there is no guarantee that interference will not occur in a particular installation. If this equipment does cause harmful interference to radio or television reception, which can be determined by turning the equipment off and on, the user is encouraged to try to correct the interference by one or more of the following measures:

- ◆ Reorient or relocate the receiving antenna.
- ◆ Increase the separation between the equipment and receiver.
- ◆ Connect the equipment into an outlet on a circuit different from that to which the receiver is connected.
- ◆ Consult the dealer or an experienced radio/ TV technician for help.

Appendix A: CERTIFICATION INFORMATION (SAR)

THIS MODEL PHONE MEETS THE GOVERNMENT'S REQUIREMENTS FOR EXPOSURE TO RADIO WAVES. Your wireless phone is a radio transmitter and receiver. It is designed and manufactured not to exceed the emission limits for exposure to radio frequency(RF) energy set by the Federal Communications Commission of the U.S. Government. These limits are part of comprehensive guidelines and establish permitted levels of RF energy for the general population. The guidelines are based on safety standards that were developed by independent scientific organizations through periodic and thorough evaluation of scientific studies. The standards include a substantial safety margin designed to assure the safety of all persons, regardless of age and health.

The exposure standard for wireless mobile phones employs a unit of measurement known as the Specific Absorption Rate (SAR). The SAR limit set by the FCC is 1.6 W/kg. SAR Tests are conducted using standard operating positions accepted by the FCC with the phone transmitting at its highest certified power level in all tested frequency bands. Although the SAR is determined at the highest certified power level, the actual SAR level of the phone while operating can be well below the maximum value. This is because the phone is designed to operate at multiple power levels so as to use only the power required to reach the network. In general, the closer you are to a wireless base station antenna, the lower the power output.

Before a new model phone is available for sale to the public, it must be tested and certified to the FCC that it does not exceed the limit established by the government-adopted requirement for safe exposure. The tests are performed in positions and locations (e.g., at the ear and worn on the body) as required by the FCC for each model. The highest SAR values for this model phone as reported to the FCC are Head: 0.255 W/Kg, Body-worn: 0.544W/Kg. Body-worn operations are restricted to Samsung-supplied, approved or none Samsung designated accessories that have no metal and must provide at least 1.5cm separation between the device, including its antenna whether extended or retracted, and the user's body. Non-compliance to the above restrictions may violate FCC RF exposure guidelines.

The FCC has granted an Equipment Authorization for this model phone with all reported SAR levels evaluated as in compliance with the FCC RF exposure guidelines. SAR information on this model phone is on file with the FCC and can be found under the Display Grant section of <http://www.fcc.gov/oet/fccid> after searching on FCC ID A3LSGHC207.

In the United States and Canada, the SAR limit for mobile phones used by the public is 1.6 watts/kilogram (W/kg) averaged over one gram of tissue. The standard incorporates a substantial margin of safety to give additional protection for the public and to account for any variations in measurements.

Appendix B: Guide to Safe and Responsible Wireless Phone Use

Cellular Telecommunications & Internet Association
“Safety is the most important call you will ever make.”
A Guide to Safe and Responsible Wireless Phone Use
TENS OF MILLIONS OF PEOPLE IN THE U.S. TODAY TAKE ADVANTAGE OF THE UNIQUE COMBINATION OF CONVENIENCE, SAFETY AND VALUE DELIVERED BY THE WIRELESS TELEPHONE. QUITE SIMPLY, THE WIRELESS PHONE GIVES PEOPLE THE POWERFUL ABILITY TO COMMUNICATE BY VOICE-ALMOST ANYWHERE, ANYTIME-WITH THE BOSS, WITH A CLIENT, WITH THE KIDS, WITH EMERGENCY PERSONNEL OR EVEN WITH THE POLICE. EACH YEAR, AMERICANS MAKE BILLIONS OF CALLS FROM THEIR WIRELESS PHONES, AND THE NUMBERS ARE RAPIDLY GROWING.

But an important responsibility accompanies those benefits, one that every wireless phone user must uphold. When driving a car, driving is your first responsibility. A wireless phone can be an invaluable tool, but good judgment must be exercised at all times while driving a motor vehicle-whether on the phone or not.

The basic lessons are ones we all learned as teenagers. Driving requires alertness, caution and courtesy. It requires a heavy dose of basic common sense-keep your head up, keep your eyes on the road, check your mirrors frequently and watch out for other drivers. It requires obeying all traffic signs and signals and staying within the speed limit.

It means using seat belts and requiring other passengers to do the same.

But with wireless phone use, driving safely means a little more. This brochure is a call to wireless phone users everywhere to make safety their first priority when behind the wheel of a car. Wireless telecommunications is keeping us in touch, simplifying our lives, protecting us in emergencies and providing opportunities to help others in need. When it comes to the use of wireless phones, safety is your most important call.

Wireless Phone “Safety Tips”

Below are safety tips to follow while driving and using a wireless phone which should be easy to remember:

1. Get to know your wireless phone and its features such as speed dial and redial. Carefully read your instruction manual and learn to take advantage of valuable features most phones offer, including automatic redial and memory. Also, work to memorize the phone keypad so you can use the speed dial function without taking your attention off the road.
2. When available, use a hands free device. A number of hands free wireless phone accessories are readily available today. Whether you choose an installed mounted device for your wireless phone or a speaker phone accessory, take advantage of these devices if available to you.
3. Position your wireless phone within easy reach. Make sure you place your wireless phone within easy reach and where you can grab it without removing your eyes

from the road. If you get an incoming call at an inconvenient time, if possible, let your voice mail answer it for you.

4. Suspend conversations during hazardous driving conditions or situations. Let the person you are speaking with know you are driving; if necessary, suspend the call in heavy traffic or hazardous weather conditions. Rain, sleet, snow and ice can be hazardous, but so is heavy traffic. As a driver, your first responsibility is to pay attention to the road.
5. Do not take notes or look up phone numbers while driving. If you are reading an address book or business card, or writing a “to do” list while driving a car, you are not watching where you are going. It’s common sense. Don’t get caught in a dangerous situation because you are reading or writing and not paying attention to the road or nearby vehicles.
6. Dial sensibly and assess the traffic; if possible, place calls when you are not moving or before pulling into traffic. Try to plan your calls before you begin your trip or attempt to coincide your calls with times you may be stopped at a stop sign, red light or otherwise stationary. But if you need to dial while driving, follow this simple tip-dial only a few numbers, check the road and your mirrors, then continue.
7. Do not engage in stressful or emotional conversations that may be distracting. Stressful or emotional conversations and driving do not mix-they are distracting and even dangerous when you are behind the wheel of a car. Make people you are talking with

aware you are driving and if necessary, suspend conversations which have the potential to divert your attention from the road.

8. Use your wireless phone to call for help. Your wireless phone is one of the greatest tools you can own to protect yourself and your family in dangerous situations-with your phone at your side, help is only three numbers away. Dial 9-1-1 or other local emergency number in the case of fire, traffic accident, road hazard or medical emergency. Remember, it is a free call on your wireless phone!
9. Use your wireless phone to help others in emergencies. Your wireless phone provides you a perfect opportunity to be a “Good Samaritan” in your community. If you see an auto accident, crime in progress or other serious emergency where lives are in danger, call 9-1-1 or other local emergency number, as you would want others to do for you.
10. Call roadside assistance or a special wireless non-emergency assistance number when necessary. Certain situations you encounter while driving may require attention, but are not urgent enough to merit a call for emergency services. But you still can use your wireless phone to lend a hand. If you see a broken-down vehicle posing no serious hazard, a broken traffic signal, a minor traffic accident where no one appears injured or a vehicle you know to be stolen, call roadside assistance or other special non-emergency wireless number.

Careless, distracted individuals and people driving irresponsibly represent a hazard to everyone on the road. Since 1984, the Cellular Telecommunications Industry Association and the wireless industry have conducted educational outreach to inform wireless phone users of their responsibilities as safe drivers and good citizens. As we approach a new century, more and more of us will take advantage of the benefits of wireless telephones. And, as we take to the roads, we all have a responsibility to drive safely.

“The wireless industry reminds you to use your phone safely when driving.”

Cellular Telecommunications & Internet Association
For more information, please call 1-888-901-SAFE. For updates: <http://www.wow-com.com/consumer/issues/driving/articles.cfm?ID=85>

Appendix C: Consumer Update on Wireless Phones

U.S. Food and Drug Administration

1. What kinds of phones are the subject of this update?

The term wireless phone refers here to hand-held wireless phones with built-in antennas, often called cell, mobile, or PCS phones. These types of wireless phones can expose the user to measurable radio frequency energy (RF) because of the short distance between the phone and the user's head. These RF exposures are limited by Federal Communications Commission safety guidelines that were developed with the advice of FDA and other federal health and safety agencies. When the phone is located at greater distances from the user, the exposure to RF is drastically lower because a person's RF exposure decreases rapidly with increasing distance from the source. The so-called "cordless phones," which have a base unit connected to the telephone wiring in a house, typically operate at far lower power levels, and thus produce RF exposures well within the FCC's compliance limits.

2. Do wireless phones pose a health hazard?

The available scientific evidence does not show that any health problems are associated with using wireless phones. There is no proof, however, that wireless phones are absolutely safe. Wireless phones emit low levels of radio frequency energy (RF) in the microwave range while being used. They also emit very low levels of RF when in the stand-by mode. Whereas high levels of RF can

produce health effects (by heating tissue), exposure to low level RF that does not produce heating effects causes no known adverse health effects. Many studies of low level RF exposures have not found any biological effects. Some studies have suggested that some biological effects may occur, but such findings have not been confirmed by additional research. In some cases, other researchers have had difficulty in reproducing those studies, or in determining the reasons for inconsistent results.

3. What is FDA's role concerning the safety of wireless phones?

Under the law, FDA does not review the safety of radiation-emitting consumer products such as wireless phones before they can be sold, as it does with new drugs or medical devices. However, the agency has authority to take action if wireless phones are shown to emit radio frequency energy (RF) at a level that is hazardous to the user. In such a case, FDA could require the manufacturers of wireless phones to notify users of the health hazard and to repair, replace or recall the phones so that the hazard no longer exists.

Although the existing scientific data do not justify FDA regulatory actions, FDA has urged the wireless phone industry to take a number of steps, including the following:

- Support needed research into possible biological effects of RF of the type emitted by wireless phones;
- Design wireless phones in a way that minimizes any RF exposure to the user that is not necessary for device function; and
- Cooperate in providing users of wireless phones with the best possible information on possible

effects of wireless phone use on human health FDA belongs to an interagency working group of the federal agencies that have responsibility for different aspects of RF safety to ensure coordinated efforts at the federal level. The following agencies belong to this working group:

- National Institute for Occupational Safety and Health
- Environmental Protection Agency
- Federal Communications Commission
- Occupational Safety and Health Administration
- National Telecommunications and Information Administration

The National Institutes of Health participates in some interagency working group activities, as well.

FDA shares regulatory responsibilities for wireless phones with the Federal Communications Commission (FCC). All phones that are sold in the United States must comply with FCC safety guidelines that limit RF exposure. FCC relies on FDA and other health agencies for safety questions about wireless phones.

FCC also regulates the base stations that the wireless phone networks rely upon. While these base stations operate at higher power than do the wireless phones themselves, the RF exposures that people get from these base stations are typically thousands of times lower than those they can get from wireless phones. Base stations are thus not the primary subject of the safety questions discussed in this document.

4. What is FDA doing to find out more about the possible health effects of wireless phone RF?

FDA is working with the U.S. National Toxicology Program and with groups of investigators around the world to ensure that high priority animal studies are conducted to address important questions about the effects of exposure to radio frequency energy (RF).

FDA has been a leading participant in the World Health Organization International Electromagnetic Fields (EMF) Project since its inception in 1996. An influential result of this work has been the development of a detailed agenda of research needs that has driven the establishment of new research programs around the world. The Project has also helped develop a series of public information documents on EMF issues.

FDA and the Cellular Telecommunications & Internet Association (CTIA) have a formal Cooperative Research and Development Agreement (CRADA) to do research on wireless phone safety. FDA provides the scientific oversight, obtaining input from experts in government, industry, and academic organizations. CTIA-funded research is conducted through contracts to independent investigators. The initial research will include both laboratory studies and studies of wireless phone users. The CRADA will also include a broad assessment of additional research needs in the context of the latest research developments around the world.

5. What steps can I take to reduce my exposure to radio frequency energy from my wireless phone?

If there is a risk from these products—and at this point we do not know that there is—it is probably very small. But if you are concerned about avoiding even potential risks, you can take a few simple steps to minimize your

exposure to radio frequency energy (RF). Since time is a key factor in how much exposure a person receives, reducing the amount of time spent using a wireless phone will reduce RF exposure.

If you must conduct extended conversations by wireless phone every day, you could place more distance between your body and the source of the RF, since the exposure level drops off dramatically with distance. For example, you could use a headset and carry the wireless phone away from your body or use a wireless phone connected to a remote antenna

Again, the scientific data do not demonstrate that wireless phones are harmful. But if you are concerned about the RF exposure from these products, you can use measures like those described above to reduce your RF exposure from wireless phone use.

6. What about children using wireless phones?

The scientific evidence does not show a danger to users of wireless phones, including children and teenagers. If you want to take steps to lower exposure to radio frequency energy (RF), the measures described above would apply to children and teenagers using wireless phones. Reducing the time of wireless phone use and increasing the distance between the user and the RF source will reduce RF exposure.

Some groups sponsored by other national governments have advised that children be discouraged from using wireless phones at all. For example, the government in the United Kingdom distributed leaflets containing such a recommendation in December 2000. They noted that no

evidence exists that using a wireless phone causes brain tumors or other ill effects. Their recommendation to limit wireless phone use by children was strictly precautionary; it was not based on scientific evidence that any health hazard exists.

7. Do hands-free kits for wireless phones reduce risks from exposure to RF emissions?

Since there are no known risks from exposure to RF emissions from wireless phones, there is no reason to believe that hands-free kits reduce risks. Hands-free kits can be used with wireless phones for convenience and comfort. These systems reduce the absorption of RF energy in the head because the phone, which is the source of the RF emissions, will not be placed against the head. On the other hand, if the phone is mounted against the waist or other part of the body during use, then that part of the body will absorb more RF energy. Wireless phones marketed in the U.S. are required to meet safety requirements regardless of whether they are used against the head or against the body. Either configuration should result in compliance with the safety limit.

8. Do wireless phone accessories that claim to shield the head from RF radiation work?

Since there are no known risks from exposure to RF emissions from wireless phones, there is no reason to believe that accessories that claim to shield the head from those emissions reduce risks. Some products that claim to shield the user from RF absorption use special phone cases, while others involve nothing more than a metallic accessory attached to the phone. Studies have shown that

these products generally do not work as advertised. Unlike “hand-free” kits, these so-called “shields” may interfere with proper operation of the phone. The phone may be forced to boost its power to compensate, leading to an increase in RF absorption. In February 2002, the Federal Trade Commission (FTC) charged two companies that sold devices that claimed to protect wireless phone users from radiation with making false and unsubstantiated claims. According to FTC, these defendants lacked a reasonable basis to substantiate their claim.

9. What about wireless phone interference with medical equipment?

Radio frequency energy (RF) from wireless phones can interact with some electronic devices. For this reason, FDA helped develop a detailed test method to measure electromagnetic interference (EMI) of implanted cardiac pacemakers and defibrillators from wireless telephones. This test method is now part of a standard sponsored by the Association for the Advancement of Medical instrumentation (AAMI). The final draft, a joint effort by FDA, medical device manufacturers, and many other groups, was completed in late 2000. This standard will allow manufacturers to ensure that cardiac pacemakers and defibrillators are safe from wireless phone EMI. FDA has tested hearing aids for interference from handheld wireless phones and helped develop a voluntary standard sponsored by the Institute of Electrical and Electronic Engineers (IEEE). This standard specifies test methods and performance requirements for hearing aids and wireless phones so that no interference occurs when a person uses a compatible phone and a compatible

hearing aid at the same time. This standard was approved by the IEEE in 2000.

FDA continues to monitor the use of wireless phones for possible interactions with other medical devices. Should harmful interference be found to occur, FDA will conduct testing to assess the interference and work to resolve the problem.

10. What are the results of the research done already?

The research done thus far has produced conflicting results, and many studies have suffered from flaws in their research methods. Animal experiments investigating the effects of radiofrequency energy (RF) exposures characteristic of wireless phones have yielded conflicting results that often cannot be repeated in other laboratories. A few animal studies, however, have suggested that low levels of RF could accelerate the development of cancer in laboratory animals. However, many of the studies that showed increased tumor development used animals that had been genetically engineered or treated with cancer-causing chemicals so as to be pre-disposed to develop cancer in the absence of RF exposure. Other studies exposed the animals to RF for up to 22 hours per day. These conditions are not similar to the conditions under which people use wireless phones, so we don't know with certainty what the results of such studies mean for human health.

Three large epidemiology studies have been published since December 2000. Between them, the studies investigated any possible association between the use of wireless phones and primary brain cancer, glioma, meningioma, or acoustic neuroma, tumors of the brain or

salivary gland, leukemia, or other cancers. None of the studies demonstrated the existence of any harmful health effects from wireless phone RF exposures. However, none of the studies can answer questions about long-term exposures, since the average period of phone use in these studies was around three years.

11. What research is needed to decide whether RF exposure from wireless phones poses a health risk?

A combination of laboratory studies and epidemiological studies of people actually using wireless phones would provide some of the data that are needed. Lifetime animal exposure studies could be completed in a few years. However, very large numbers of animals would be needed to provide reliable proof of a cancer promoting effect if one exists. Epidemiological studies can provide data that is directly applicable to human populations, but 10 or more years follow-up may be needed to provide answers about some health effects, such as cancer. This is because the interval between the time of exposure to a cancer-causing agent and the time tumors develop - if they do - may be many, many years. The interpretation of epidemiological studies is hampered by difficulties in measuring actual RF exposure during day-to-day use of wireless phones. Many factors affect this measurement, such as the angle at which the phone is held, or which model of phone is used.

12. Which other federal agencies have responsibilities related to potential RF health effects?

Additional information on the safety of RF exposures from various sources can be obtained from the following organizations.

FCC RF Safety Program:

<http://www.fcc.gov/oet/rfsafety/>

Environmental Protection Agency (EPA):

<http://www.epa.gov/radiation/>

Occupational Safety and Health Administration's (OSHA):

<http://www.osha-slc.gov/SLTC/radiofrequencyradiation/index.html>

National Institute for Occupational Safety and Health (NIOSH):

<http://www.cdc.gov/niosh/emfpg.html>

World health Organization (WHO):

<http://www.who.int/peh-emf/>

International Commission on Non-Ionizing Radiation Protection:

<http://www.icnirp.de>

National Radiation Protection Board (UK):

<http://www.nrpb.org.uk>

Updated 4/3/2002: US Food and Drug Administration

<http://www.fda.gov/cellphones>

Standard Limited Warranty

What is Covered and For How Long? SAMSUNG TELECOMMUNICATIONS AMERICA, L.P. ("SAMSUNG") warrants to the original purchaser ("Purchaser") that SAMSUNG's Phones and accessories ("Products") are free from defects in material and workmanship under normal use and service for the period commencing upon

the date of purchase and continuing for the following specified period of time after that date:

Phone	1 Year
Batteries	1 Year
Leather Case/ Pouch	90 Days
Holster	90 Days
Other Phone Accessories	1 Year

What is Not Covered? This Limited Warranty is conditioned upon proper use of Product by Purchaser. This Limited Warranty does not cover: (a) defects or damage resulting from accident, misuse, abuse, neglect, unusual physical, electrical or electromechanical stress, or modification of any part of Product, including antenna, or cosmetic damage; (b) equipment that has the serial number removed or made illegible; (c) any plastic surfaces or other externally exposed parts that are scratched or damaged due to normal use; (d) malfunctions resulting from the use of Product in conjunction with accessories, products, or ancillary/peripheral equipment not furnished or approved by SAMSUNG; (e) defects or damage from improper testing, operation, maintenance, installation, or adjustment; (f) installation, maintenance, and service of Product, or (g) Product used or purchased outside the United States or Canada. This Limited Warranty covers batteries only if battery capacity falls below 80% of rated capacity or the battery leaks, and this Limited Warranty does not cover any battery if (i) the battery has been charged by a battery charger not specified or approved by

SAMSUNG for charging the battery, (ii) any of the seals on the battery are broken or show evidence of tampering, or (iii) the battery has been used in equipment other than the SAMSUNG phone for which it is specified.

What are SAMSUNG's Obligations? During the applicable warranty period, SAMSUNG will repair or replace, at SAMSUNG's sole option, without charge to Purchaser, any defective component part of Product. To obtain service under this Limited Warranty, Purchaser must return Product to an authorized phone service facility in an adequate container for shipping, accompanied by Purchaser's sales receipt or comparable substitute proof of sale showing the date of purchase, the serial number of Product and the sellers' name and address. To obtain assistance on where to deliver the Product, call Samsung Customer Care at 1-888-987-4357. Upon receipt, SAMSUNG will promptly repair or replace the defective Product. SAMSUNG may, at SAMSUNG's sole option, use rebuilt, reconditioned, or new parts or components when repairing any Product or replace Product with a rebuilt, reconditioned or new Product. Repaired/replaced leather cases, pouches and holsters will be warranted for a period of ninety (90) days. All other repaired/replaced Product will be warranted for a period equal to the remainder of the original Limited Warranty on the original Product or for 90 days, whichever is longer. All replaced parts, components, boards and equipment shall become the property of SAMSUNG. If SAMSUNG determines that any Product is not covered by this Limited Warranty, Purchaser must pay all parts, shipping, and labor charges for the repair or return of such Product.

What Are the Limits On SAMSUNG's Liability?

EXCEPT AS SET FORTH IN THE EXPRESS WARRANTY CONTAINED HEREIN, PURCHASER TAKES THE PRODUCT "AS IS," AND SAMSUNG MAKES NO WARRANTY OR REPRESENTATION AND THERE ARE NO CONDITIONS, EXPRESS OR IMPLIED, STATUTORY OR OTHERWISE, OF ANY KIND WHATSOEVER WITH RESPECT TO THE PRODUCT, INCLUDING BUT NOT LIMITED TO:

- ◆ THE MERCHANTABILITY OF THE PRODUCT OR ITS FITNESS FOR ANY PARTICULAR PURPOSE OR USE;
- ◆ WARRANTIES OF TITLE OR NON-INFRINGEMENT;
- ◆ DESIGN, CONDITION, QUALITY, OR PERFORMANCE OF THE PRODUCT;
- ◆ THE WORKMANSHIP OF THE PRODUCT OR THE COMPONENTS CONTAINED THEREIN; OR
- ◆ COMPLIANCE OF THE PRODUCT WITH THE REQUIREMENTS OF ANY LAW, RULE, SPECIFICATION OR CONTRACT PERTAINING THERETO.

NOTHING CONTAINED IN THE INSTRUCTION MANUAL SHALL BE CONSTRUED TO CREATE AN EXPRESS WARRANTY OF ANY KIND WHATSOEVER WITH RESPECT TO THE PRODUCT. ALL IMPLIED WARRANTIES AND CONDITIONS THAT MAY ARISE BY OPERATION OF LAW, INCLUDING IF APPLICABLE THE IMPLIED WARRANTIES OF MERCHANTABILITY AND FITNESS FOR A PARTICULAR PURPOSE, ARE HEREBY LIMITED TO THE SAME DURATION OF TIME AS THE EXPRESS WRITTEN WARRANTY STATED HEREIN. SOME STATES/PROVINCES DO NOT ALLOW LIMITATIONS ON HOW LONG AN IMPLIED WARRANTY LASTS, SO THE ABOVE LIMITATION MAY NOT APPLY

TO YOU. IN ADDITION, SAMSUNG SHALL NOT BE LIABLE FOR ANY DAMAGES OF ANY KIND RESULTING FROM THE PURCHASE, USE, OR MISUSE OF, OR INABILITY TO USE THE PRODUCT OR ARISING DIRECTLY OR INDIRECTLY FROM THE USE OR LOSS OF USE OF THE PRODUCT OR FROM THE BREACH OF THE EXPRESS WARRANTY, INCLUDING INCIDENTAL, SPECIAL, CONSEQUENTIAL OR SIMILAR DAMAGES, OR LOSS OF ANTICIPATED PROFITS OR BENEFITS, OR FOR DAMAGES ARISING FROM ANY TORT (INCLUDING NEGLIGENCE OR GROSS NEGLIGENCE) OR FAULT COMMITTED BY SAMSUNG, ITS AGENTS OR EMPLOYEES, OR FOR ANY BREACH OF CONTRACT OR FOR ANY CLAIM BROUGHT AGAINST PURCHASER BY ANY OTHER PARTY. SOME STATES/PROVINCES DO NOT ALLOW THE EXCLUSION OR LIMITATION OF INCIDENTAL OR CONSEQUENTIAL DAMAGES, SO THE ABOVE LIMITATION OR EXCLUSION MAY NOT APPLY TO YOU.

THIS WARRANTY GIVES YOU SPECIFIC LEGAL RIGHTS, AND YOU MAY ALSO HAVE OTHER RIGHTS, WHICH VARY FROM STATE TO STATE/PROVINCE TO PROVINCE. THIS LIMITED WARRANTY SHALL NOT EXTEND TO ANYONE OTHER THAN THE ORIGINAL PURCHASER OF THIS PRODUCT AND STATES PURCHASER'S EXCLUSIVE REMEDY. IF ANY PORTION OF THIS LIMITED WARRANTY IS HELD ILLEGAL OR UNENFORCEABLE BY REASON OF ANY LAW, SUCH PARTIAL ILLEGALITY OR UNENFORCEABILITY SHALL NOT AFFECT THE ENFORCEABILITY FOR THE REMAINDER OF THIS

LIMITED WARRANTY WHICH PURCHASER ACKNOWLEDGES IS AND WILL ALWAYS BE CONSTRUED TO BE LIMITED BY ITS TERMS OR AS LIMITED AS THE LAW PERMITS.

THE PARTIES UNDERSTAND THAT THE PURCHASER MAY USE THIRD-PARTY SOFTWARE OR EQUIPMENT IN CONJUNCTION WITH THE PRODUCT. SAMSUNG MAKES NO WARRANTIES OR REPRESENTATIONS AND THERE ARE NO CONDITIONS, EXPRESS OR IMPLIED, STATUTORY OR OTHERWISE, AS TO THE QUALITY, CAPABILITIES, OPERATIONS, PERFORMANCE OR SUITABILITY OF ANY THIRD-PARTY SOFTWARE OR EQUIPMENT, WHETHER SUCH THIRD-PARTY SOFTWARE OR EQUIPMENT IS INCLUDED WITH THE PRODUCT DISTRIBUTED BY SAMSUNG OR OTHERWISE, INCLUDING THE ABILITY TO INTEGRATE ANY SUCH SOFTWARE OR EQUIPMENT WITH THE PRODUCT. THE QUALITY, CAPABILITIES, OPERATIONS, PERFORMANCE AND SUITABILITY OF ANY SUCH THIRD-PARTY SOFTWARE OR EQUIPMENT LIE SOLELY WITH THE PURCHASER AND THE DIRECT VENDOR, OWNER OR SUPPLIER OF SUCH THIRD-PARTY SOFTWARE OR EQUIPMENT, AS THE CASE MAY BE.

This Limited Warranty allocates risk of Product failure between Purchaser and SAMSUNG, and SAMSUNG's Product pricing reflects this allocation of risk and the limitations of liability contained in this Limited Warranty. The agents, employees, distributors, and dealers of SAMSUNG are not authorized to make modifications to this Limited Warranty, or make additional warranties binding on SAMSUNG. Accordingly, additional statements

such as dealer advertising or presentation, whether oral or written, do not constitute warranties by SAMSUNG and should not be relied upon.

Samsung Telecommunications America, L.P.

1301 East Lookout Drive

Richardson, Texas 75082

Phone: 1-800-SAMSUNG

Phone: 1-888-987-HELP (4357)

©2004 Samsung Telecommunications America. All rights reserved.

No reproduction in whole or in part allowed without prior written approval.

Specifications and availability subject to change without notice. [080802]

Glossary

To help you understand the main technical terms and abbreviations used in this booklet and take full advantage of the features on your mobile phone, here are a few definitions.

Call Forwarding

Ability to reroute calls to another number.

Call Holding

Ability to put one call on standby while answering or making another call; you can then switch between the two calls, as required.

Call Waiting

Ability to inform users that they have an incoming call when engaged on another call.

Caller Line Identification Services (Caller ID)

Services allowing subscribers to view or block the telephone numbers of callers.

Dual Band

Ability to operate with both GSM (1900 MHz) and GSM (850 MHz) networks. The phone automatically uses the network with strongest signal and even switches networks during a call within the same operator's network.

EMS (Enhanced Message Service)

An adaptation of the Short Message Service (SMS) that allows you to create combinations of simple media to and from EMS-compliant handsets. EMS users can send/receive

text messages and that include simple sounds, melodies, pictures, and animations to enhance the expressive power of messages that are limited by the display constraints of mobile devices.

Because EMS is based on SMS, it can use SMS centers the same way that SMS does. EMS works on all Global System for Mobile communications (GSM) networks.

GSM (Global System for Mobile Communication)

International standard for cellular communication, guaranteeing compatibility between the various network operators. GSM covers most European countries and many other parts of the world.

Java

Programming language generating applications that can run on all hardware platforms, whether small, medium or large, without modification. It has been promoted for and geared heavily to the Web, both for public Web sites and Intranets. When a Java program runs from a Web page, it is called a Java applet. When it is run on a mobile phone or pager, it is called a MIDlet.

Multi-party Calling

Ability to establish a conference call involving up to five additional parties.

Phone Password

Security code used to unlock the phone when you have selected the option to lock it automatically each time it switches on.

PIN (Personal Identification Number)

Security code that protects the phone/SIM against unauthorized use. The PIN is supplied by the service provider with the SIM card. It may be a four to eight-digit number and can be changed, as required.

Proxy Server

A server that resides between a web client, such as a web browser, and a real Web server and acts as an intermediary between them. When some people browse a web site, their browser is not actually connecting to the web server. The request from their browser goes to a proxy server, and the proxy server makes the request to the web server.

A proxy server can improve performance for groups of users because it cache the results of all requests for a certain amount of time. If a user requests a web page that it already fetched for another user, it returns the page instead of forwarding the request to the Web server, which can be a time-consuming operation.

PUK (PIN Unblocking Key)

Security code that protects the phone/SIM against unauthorized use. The PIN is supplied by the service provider with the SIM card. It may be a four to eight-digit number and can be changed, as required.

Roaming

Use of your phone when you are outside your home area (when traveling for example).

SIM (Subscriber Identification Module)

Card containing a chip with all the information required to operate the phone (network and memory information, as well as the subscriber's personal data). The SIM card fits into a

small slot on the back of the phone and is protected by the battery.

SMS (Short Message Service)

Network service sending and receiving messages to and from another subscriber without having to speak to the correspondent. The message created or received can be displayed, received, edited or sent.

Soft Keys

Two keys marked  and  on the phone, the purpose of which:

- ◆ varies according to the function that you are currently using
- ◆ is indicated on the bottom line of the display just above the corresponding key.

Voice Mail

Computerized answering service that automatically answers your calls when you are not available, plays a greeting (optionally in your own voice) and records a message.

Index

A

Access codes •, 167

Alarm •, 129

Alert type •, 126

Answering

call •, 30

second call •, 62

Anykey answer •, 160

Auto redial •, 160

B

Background image •, 153

Backlight

description •, 20

Barring, calls •, 110

Battery

charging •, 23

installing •, 23

low indicator •, 25

precautions •, 174

Broadcast messages •, 88

C

Calculator •, 134

Calendar memos

copying •, 132

erasing •, 132

viewing •, 132

writing •, 131

Call back, message •, 82

Call records

made •, 75

missed •, 31, 75

Call time •, 77

Caller groups

editing •, 45

searching •, 44

Caller ID •, 113

Calls

answering •, 30, 62

barring •, 110

ending •, 28

forwarding •, 109

holding •, 59

making •, 27

redialing •, 28

rejecting •, 30

waiting •, 62, 112

Calls Made, 75

calls received •, 75

CB (Cell Broadcast) messages

•, 88

Characters, enter •, 51

Charging battery •, 23

Closed User Group (CUG) •, 114

Conference call •, 63

Connect tone •, 128

Contrast, display •, 154

Currency exchange •, 142

D

Date, set •, 133

Deleting

calendar memo •, 132

multimedia message •, 94,

96, 97

Recent Calls •, 75

task •, 136, 139

text message •, 82, 83

voice memo •, 141

Delivery reports, message •, 87

Display

backlight •, 20

icons •, 18

- layout •, 16
- settings •, 153

Downloading

- games •, 117

DTMF tones, send •, 61

E

- Earpiece volume •, 29
- Emergency calls •, 179
- EMS (Enhanced Message Service) •, 79
- Error tone •, 128

F

- FDN (Fixed Dial Number) mode •, 159
- Forwarding
 - multimedia message •, 94, 96
- Forwarding, calls •, 109

G

- Games
 - downloading •, 117
 - playing •, 117
- Graphic logo •, 155
- Greeting message •, 155

H

- Health and safety •, 171
- Holding, call •, 59

I

- Icons, description •, 18
- Images
 - viewing •, 149
- Inbox, messages •, 82
- International calls •, 27

J

- Java service •, 117

K

- Key volume •, 30
- Keypad tones
 - selecting •, 126
 - sending •, 61

Keys

- description •, 13
- location •, 13
- shortcut •, 160

L

- Language, select •, 156
- Last number, redial •, 28
- Locking
 - media contents •, 158
 - phone •, 157
- Low battery indicator •, 25
- Lower-case characters
 - entering •, 55

M

- Memory status
 - downloaded items •, 151
 - phonebook •, 48
 - text messages •, 87
- Menu style •, 154

Menus

- accessing •, 67
- list •, 68

- Message tone •, 126

Messages

- cell broadcast •, 88
- greeting •, 155
- multimedia •, 149
- reading •, 82
- setting •, 84
- text •, 79

- MIDlets, launch •, 117

- Minute minder •, 128

- Missed calls •, 31, 75
- Morning call •, 129
- Multimedia messages
 - deleting •, 96, 97
 - editing •, 97
 - setting •, 90
- Multi-party calls •, 63
- Muting
 - all sounds •, 32
 - key tones •, 61
 - microphone •, 60
- N**
- Names
 - entering •, 51
 - searching/dialing •, 43
- Network selection •, 113
- Network services •, 109
- Numbers, phone
 - searching/dialing •, 43
 - storing •, 39
- O**
- On/off switch, phone •, 25
- Organizer •, 129
- Outbox, messages •, 83
- Own number •, 155
- P**
- Password
 - call barring •, 112
 - phone •, 157, 167
- Phone
 - care and maintenance •, 181
 - display •, 16
 - icons •, 18
 - keys •, 13
 - layout •, 13
 - locking •, 157
 - password •, 167
 - resetting •, 161
 - switching on/off •, 25
 - unpacking •, 11
- Phonebook
 - copying •, 42
 - editing •, 41
 - options •, 41
 - searching/dialing •, 43
 - speed-dialing •, 47
 - storing •, 39
- Pictures, downloaded •, 149
- PIN
 - changing •, 157
 - description •, 168
- PIN2
 - changing •, 159
 - description •, 169
- Power on/off tone •, 127
- Problems, solving •, 163
- PUK •, 168
- PUK2 •, 169
- R**
- Radio-frequency •, 171
- Received calls •, 75
- Received messages •, 82
- Recording
 - voice memos •, 140
- Redialing
 - automatically •, 160
 - manually •, 28
- Resetting phone •, 161
- Ring tone •, 125
- Ring type •, 126
- Ring volume •, 125
- Road safety •, 175
- Roaming •, 113

S

Safety

- information •, 171

Scheduler •, 130

SDN (Service Dialling Numbers)
•, 49

Searching, phonebook •, 43

Security, calls •, 156

Sent messages, text •, 83

Shortcut, menu •, 160

SIM card

- installing •, 21

SIM Lock •, 158

SMS (Short Message Service)

- Inbox •, 82

- Outbox •, 83

Soft keys •, 35

Sound settings •, 125

Speed-dialing •, 47

Switching on/off

- microphone •, 60

- phone •, 25

Symbol mode, text input •, 57

T

T9 mode, text input •, 53

Tasks, to do list

- creating •, 134

- editing •, 135

Templates, message, text •, 84

Text input mode •, 52

Text message

- creating/sending •, 79

- deleting •, 82, 83

- reading •, 82, 83

- setting •, 84

Text, enter •, 51

Time format •, 134

Time, set •, 133

To do list •, 134

Tone

- connect •, 128

- error •, 128

- keypad •, 126

- message •, 126

- minute minder •, 128

- power on/off •, 127

- ring •, 125

Travel adapter •, 24

U

Upper-case characters

- entering •, 55

User group •, 114

V

Vibration •, 32, 126

Voice mail •, 76

Voice memo

- deleting •, 141

- playing •, 141

- recording •, 140

Voicemail server •, 76

Volume, adjust

- keypad tone •, 30

- ring •, 125

Volume, adjusting

- earpiece •, 29

W

Waiting call •, 62, 112

Wallpaper •, 153

WAP browser

- cache, clear •, 149

- favorites •, 147

- setting •, 148

World time •, 133



Writing messages •, 79

Index

SGH-c207 GPRS Telephone Quick reference card

Access the menu functions

- 1 Press the **Menu** soft key.
- 2 Scroll using the Navigation keys through the list of the menus until you reach the menu you want.
- 3 Press the **Select** soft key.
- 4 Scroll using the Up and Down keys through the list of the options until the one you want is selected.
- 5 Press the **Select** soft key.

- Each of the two soft keys ( and ) perform the function indicated by the text above it, on the bottom line of the display.

Switch on/off

Press and hold the  key.

Make a call

- 1 Enter the number.
- 2 Press the  key.

End a call

Briefly press the  key.



View missed calls immediately after missing them

- 1 Press the **View** soft key.
- 2 Scroll using the Up and Down keys through the missed calls.
- 3 To return the call, press the  key.

Answer a call

Press the  key.

Adjust the volume

Press the  or  key on the left side of the phone.



Choose the alert type	<ol style="list-style-type: none"> ① Select the Alert type menu (Menu 6.4). ② Select an option: <ul style="list-style-type: none"> • Melody • Vibration • Vibra + Melody ③ Press the Select soft key.
Store numbers in Phone Book	<ol style="list-style-type: none"> ① Enter the number and press the Save soft key. ② Select an icon. ③ Press the Select soft key. ④ Select a memory. ⑤ Press the Select soft key. ⑥ Enter the name. ⑦ Press the OK soft key. ⑧ If necessary, change the location number. ⑨ Press the OK soft key. ⑩ Press the  key to return to Idle mode.

Search for a number in Phone Book	<ol style="list-style-type: none"> ① Press the Name soft key. ② Select the Search option. ③ Enter the first few letters of the name. ④ To scroll through the names, press the Up or Down key. ⑤ Press the View soft key. ⑥ To scroll through the numbers, press the Up or Down key. ⑦ Press the  key to dial.
-----------------------------------	--