

ICF-C733/C733L

SERVICE MANUAL

AEP Model
ICF-C733/C733L

UK Model
ICF-C733L



Photo : ICF-C733L

SPECIFICATIONS

Time display:

UK: 12-hour system

Other countries: 24-hour system

Frequency range:

Band	Frequency range	Channel step
FM	87.5 – 108 MHz	0.05 MHz*
AM (MW)	531 – 1,602 kHz	9 kHz
LW (ICF-C733L only)	153 – 281 kHz	2 kHz ⇄ 7 kHz

* The frequency display is raised or lowered by a step of 0.1 MHz. (Example: Frequency 88.05 MHz is displayed as "88.0 MHz".)

Intermediate frequency:

FM: 10.7 MHz, AM (MW): 450 kHz

Speaker:

Approx. 6.6 cm (2 5/8 inches) dia.

Power output:

120 mW (at 10 % harmonic distortion)

Power requirements:

UK: 240 V AC, 50 Hz

Other countries: 220 - 230 V AC, 50 Hz

Dimensions:

Approx. 233 × 77 × 140 mm (w/h/d)
(9 1/4 × 3 1/8 × 5 5/8 inches) incl. projecting parts and controls

Mass:

Approx. 680 g (1 lb 8 oz)

Accessory supplied:

FM antenna coupler (1, Models for Netherlands, Belgium, Switzerland, Austria and Scandinavia only)

Design and specifications are subject to change without notice.

Note

This appliance conforms with EEC Directive 87/308/EEC regarding interference suppression.

Notes on chip component replacement

- Never reuse a disconnected chip component.
- Notice that the minus side of a tantalum capacitor may be damaged by heat.

SAFETY-RELATED COMPONENT WARNING !!

COMPONENTS IDENTIFIED BY MARK Δ OR DOTTED LINE WITH MARK Δ ON THE SCHEMATIC DIAGRAMS AND IN THE PARTS LIST ARE CRITICAL TO SAFE OPERATION. REPLACE THESE COMPONENTS WITH SONY PARTS WHOSE PART NUMBERS APPEAR AS SHOWN IN THIS MANUAL OR IN SUPPLEMENTS PUBLISHED BY SONY.

ICF-C733 : FM/AM PLL SYNTHESIZED CLOCK RADIO
ICF-C733L : FM/MW/LW 3BAND PLL SYNTHESIZED CLOCK RADIO

SONY®

SECTION 1

GENERAL

This section is extracted from instruction manual.

TABLE OF CONTENTS

Section	Title	Page
1.	GENERAL	2
2.	SERVICING NOTE • Set the Power Cord and ANT. Lead	5
3.	ELECTRICAL ADJUSTMENTS	6
4.	DIAGRAMS	
4-1.	Semiconductor Lead Layouts	8
4-2.	Printed Wiring Board	9
4-3.	Schematic Diagram	11
4-4.	IC Pin Function • IC2 (μ PD1724GB-648-1P7)	14
5.	EXPLODED VIEW	15
6.	ELECTRICAL PARTS LIST	16

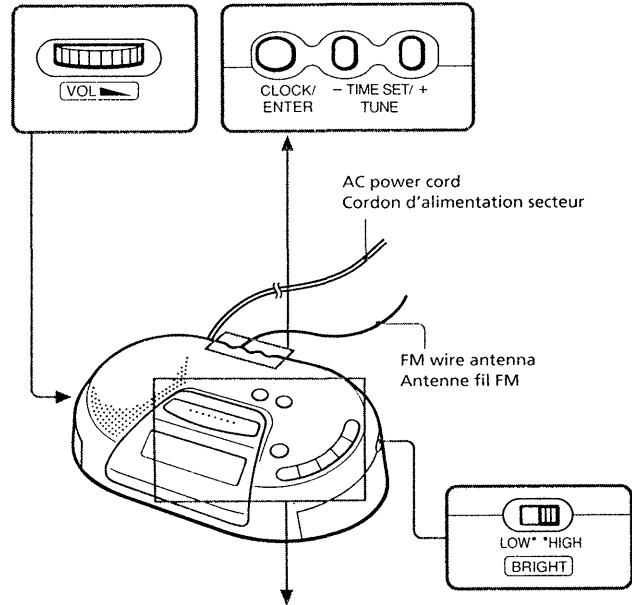

HOW TO CHANGED THE CERAMIC FILTERS

This model is used two ceramic filters of CF2 and CF3. You must used same type of color marked ceramic filters in order to meet same specifications. Therefore, the ceramic filter must changed two pieces together since it's supply two pieces in one package as a spare parts.

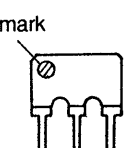
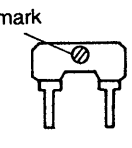
mark	mark	center frequency
 CF2	red	10.70MHz
	blue	10.67MHz
 CF3	orange	10.73MHz
	black	10.64MHz
	white	10.76MHz

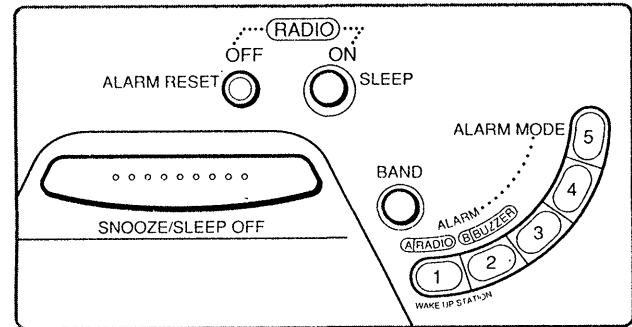

Setting the Clock

1. Plug in the unit.
The display will flash AM "12:00" or "0:00".
2. While holding down **CLOCK/ENTER**, press either + or - under **TIME SET/TUNE** till the correct time appears in the display. When you release **CLOCK/ENTER**, the clock begins to operate and ":" flashes.

- The clock system varies depending on the model you own.
12-hour system: "AM 12:00" = midnight
24-hour system: "0:00" = midnight
- To set the current time rapidly, keep pressing **CLOCK/ENTER** and the + or - button together to advance or return to a time that is within a few minutes of the current time. Then press the + or - button to set the time to the current time.

Changing the Brightness of the Display Window

To change the brightness of the display window, slide **BRIGHT** (brightness).

Operating the Radio

Manual Tuning

1. Press **RADIO ON/SLEEP** to turn on the radio. The band, frequency and preset number indications will be displayed in the display window after "On" and preset number appear for about 2 seconds. They change to the current time indication after about 10 seconds.
2. Adjust **VOL** (Volume).
3. Press **BAND** to select the band. Every push changes the band as follows. (The last frequency selected in each band appears.)

LW → AM (MW) → FM
↑

FM/AM = ICF-C733 only
FM/MW/LW = ICF-C733L only

4. Tune in a station by pressing the + or - button of **TIME SET/TUNE**.
The FM channel step is set to 0.05 MHz or (The FM frequency indication changes every 0.1 MHz).
The AM (MW) channel step is set to 9 kHz.
9 kHz for models for other countries.
The LW channel step alternates between 2 kHz and 7 kHz.
A beep sounds at the band edge.

- To turn off the radio, press **RADIO OFF/ALARM RESET**.
- To improve radio reception
FM: Extend the FM wire antenna fully to improve FM reception.
AM (MW)/LW: Rotate the unit horizontally for optimum reception. A ferrite bar antenna is built into the unit.
- To check the station you are listening to, press **RADIO ON/SLEEP**.
The band and frequency appear for 10 seconds.

For the Customers Supplied with an FM Antenna Coupler

Clamp the AC power cord with the supplied coupler and connect it to a wall FM antenna terminal for optimum FM reception.

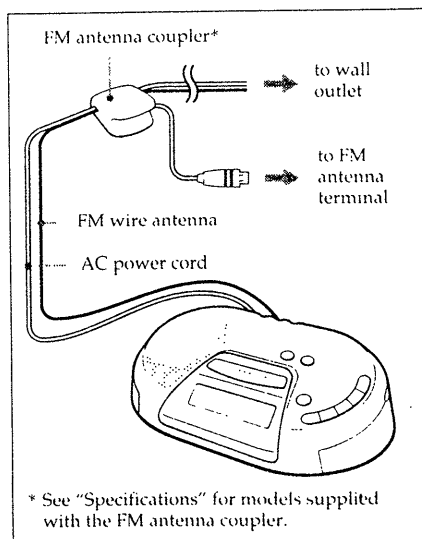

Preset Tuning

Presetting the Station

You can preset up to 5 stations in FM/AM(MW)/LW with numbered buttons 1 to 5.

Example: To set AM 1260 kHz in preset number 2.

1. Tune in to AM 1260 kHz (See "Manual Tuning").
2. Press **CLOCK/ENTER**.
"P" flashes for about 10 seconds.

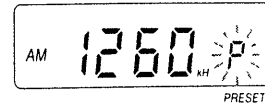

3. Press the "2" button while "P" is flashing.
The beep sounds twice and the station is preset. Though the indication changes to the current time after 10 seconds, the preset number remains.

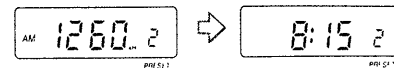

- To change the preset station, set a new station's frequency in the number whose station you want to change. The previous frequency is canceled.
- Note that the preset 1 station is used for the wake up station of the radio alarm.

Tuning in a Preset Station

1. Press **RADIO ON/SLEEP** to turn on the radio.
2. Press the preset number button of the station.
The band, frequency and preset number appear in the display window.
After 10 seconds, the indication changes to the current time. The preset number remains.

- To turn off the radio, press **RADIO OFF/ALARM RESET**.
- To check the station you are listening to, press the preset number button.
The band and frequency appear for 10 seconds.

Setting the Alarm

You can set the radio and buzzer alarms. The wake up station is that preset in number 1. To set the radio alarm, first preset a desired station for wake up to the preset number 1 (See "Preset Tuning"), and adjust the **VOL** (Volume).

1. Turn off the radio.
2. While holding down **A RADIO** or **B BUZZER**, press either **+** or **-** of **TIME SET/TUNE** till the desired time appears in the display.
The **A RADIO** or **B BUZZER** indicator flashes while these buttons are being held down.



3. Release **A RADIO** or **B BUZZER**.
The alarm time is set. The indication becomes the current time.
4. Press **ALARM MODE** till the alarm you want to set appears in the display.
Each push changes the alarm indication as follows.

No alarm → **A RADIO** → **B BUZZER**
↶ **A RADIO** / **B BUZZER** ↷

When you want to set both **A RADIO** and **B BUZZER** alarm, set both **A RADIO** and **B BUZZER** alarm time by performing steps 2 and 3 above.

The radio or buzzer will automatically sound at the preset time, and automatically turn itself off after 60 minutes, unless it is turned off manually.

- To shut off the alarm manually, press **RADIO OFF/ALARM RESET**.
The alarm will come on at the preset time the next day.
- To cancel the alarm before the alarm time, press **ALARM MODE** till the appropriate alarm indication disappears.
- To check the preset time, press **A RADIO** or **B BUZZER**.

Notes

- The buzzer sound level is fixed, and independent of the **VOL** (volume).
- If you set **A RADIO** and **B BUZZER** to the same desired time, only **A RADIO** will work.

To Doze for a Few More Minutes

1. Press **SNOOZE/SLEEP OFF**.
The radio or buzzer will shut off but will automatically come on again after about 8 minutes.
You can repeat this process within 1 hour.

When the snooze alarm function is operating, the alarm indication flashes.

Setting the SLEEP Timer

Enjoy falling asleep to the radio using the built-in sleep timer that shuts off the radio automatically at a preset time.

1. Press **RADIO ON/SLEEP** repeatedly.
The radio turns on. You can set the sleep timer of 90, 60, 30, or 15 minutes.
Each push changes the display as follows.

Current time → On → 90
 ↑ ↓
 15 ← 30 ← 60

The radio will play for the time you set, then shut off.

To turn off the radio before the preset time, press **SNOOZE/SLEEP OFF**.

To Use Both Sleep Timer and Alarm Function

You can fall asleep to the radio sound and be awakened by the radio/buzzer alarm at the preset time.

1. Set the alarm. (See "Setting the Alarm")
2. Set the sleep timer. (See "Setting Sleep Timer")

Note

When the alarm time arrives while the sleep timer is working, the sleep timer is canceled and the alarm sounds.

SECTION 2

SERVICING NOTE

• SET THE POWER CORD AND ANT. LEAD

- 1 Pull around and arrange the Power cord along the edge of the Cabinet (LOWER) as shown in the figure.
- 2 Thread and arrange the ANT. lead through a hole of the Cabinet (LOWER) as shown in the figure.

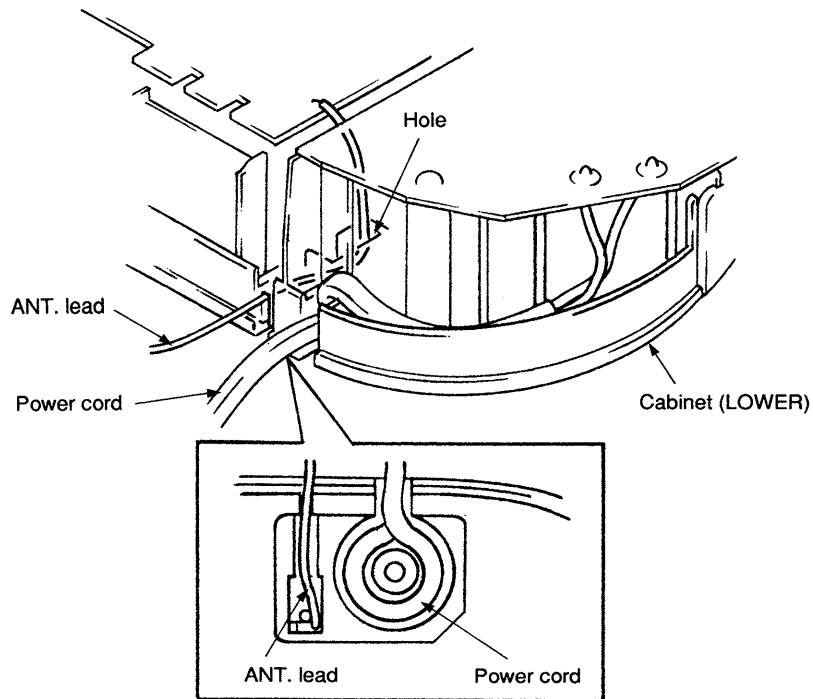

SECTION 3 ELECTRICAL ADJUSTMENTS

ICF-C733L

• MW/LW Section

Setting :

BAND switch : MW or LW

AM RF signal generator

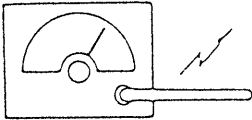

Put the lead-wire antenna close to the set.

30% amplitude modulation by 400 Hz signal
output level : as low as possible

• FM Section

Setting :

BAND switch : FM

FM RF signal generator

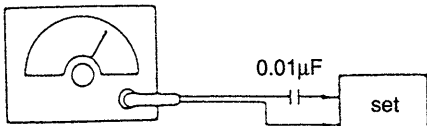

± 22.5kHz frequency deviation by 400 Hz signal
output level : as low as possible

VTVM
(range : 0.5 – 5V ac)

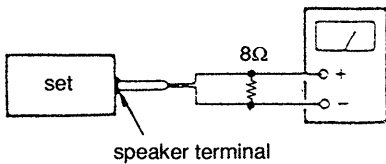

- Repeat the procedures in each adjustment several times, and the VCO voltage and the tracking adjustments should be finally done by the trimmer capacitors.

AM IF ADJUSTMENT

Adjust for a maximum reading on VTVM.

T1

450kHz

AM (MW) VCO VOLTAGE ADJUSTMENT

Adjustment Part	Frequency Display	Reading on Digital voltmeter
L6	531kHz	$2.85 \pm 0.1V$
confirmation	1,602kHz	less than 11V

Note :Not use the AM RF signal generator in this adjustment.

AM (MW) TRACKING ADJUSTMENT

Adjust for a maximum reading on VTVM.

Adjustment Part	Frequency Display	Reading on Digital voltmeter
L1-1	CT1	
621kHz	1,404kHz	

AM (LM) VCO VOLTAGE ADJUSTMENT

Adjustment Part	Frequency Display	Reading on Digital voltmeter
CT4	153kHz	$2.2 \pm 0.1V$
confirmation	281kHz	less than 10V

Note :Not use the AM RF signal generator in this adjustment.

AM (LM) TRACKING ADJUSTMENT

Adjust for a maximum reading on VTVM.

Adjustment Part	Frequency Display	Reading on Digital voltmeter
L1-2	CT2	
162kHz	243kHz	

FM VCO VOLTAGE CHECK

Adjustment Part	Frequency Display	Reading on Digital voltmeter
confirmation	87.5MHz	more than 2V
confirmation	108MHz	check $10.5 \pm 1.0V$

Note :Not use the FM RF signal generator in this adjustment.

FM TRACKING ADJUSTMENT

Adjust for a maximum reading on VTVM.

Adjustment Part	Frequency Display	Reading on Digital voltmeter
L4	CT3	
87.5MHz	108MHz	

Adjustment Location : MAIN board (Component Side)

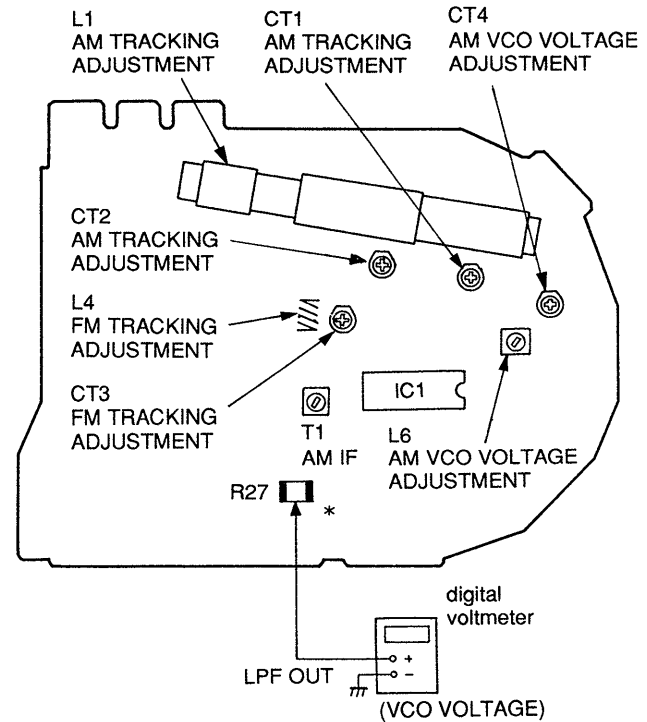

* mark is mounted on conductor side.

ICF-C733

• AM Section

Setting :

BAND switch : AM

AM RF signal generator

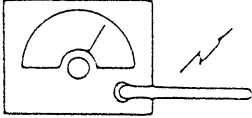

Put the lead-wire antenna close to the set.

30% amplitude modulation
by 400 Hz signal
output level : as low as possible

• FM Section

Setting :

BAND switch : FM

FM RF signal generator

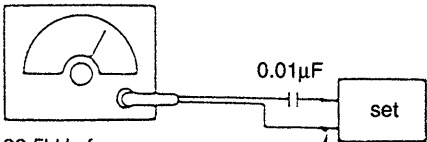

± 22.5kHz frequency deviation by 400 Hz signal
output level : as low as possible
lead antenna terminal

VTVM
(range : 0.5 – 5V ac)

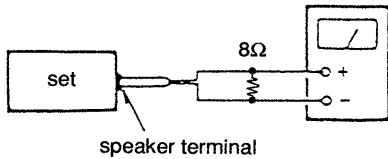

speaker terminal

- Repeat the procedures in each adjustment several times, and the VCO voltage and the tracking adjustments should be finally done by the trimmer capacitors.

AM IF ADJUSTMENT		
Adjust for a maximum reading on VTVM.		
T1		
450kHz		

AM VCO VOLTAGE ADJUSTMENT		
Adjustment Part	Frequency Display	Reading on Digital voltmeter
L6	531kHz	2.85 ± 0.1V
confirmation	1,602kHz	less than 11V

Note :Not use the AM RF signal generator in this adjustment.

AM TRACKING ADJUSTMENT		
Adjust for a maximum reading on VTVM.		
L1-1	CT1	
621kHz	1,404kHz	

FM VCO VOLTAGE CHECK

Adjustment Part	Frequency Display	Reading on Digital voltmeter
confirmation	87.5MHz	more than 2V
confirmation	108MHz	check 10.5 ± 1.0V

Note :Not use the FM RF signal generator in this adjustment.

FM TRACKING ADJUSTMENT

Adjust for a maximum reading on VTVM.

L4	CT3
87.5MHz	108MHz

Adjustment Location : MAIN board (Component Side)

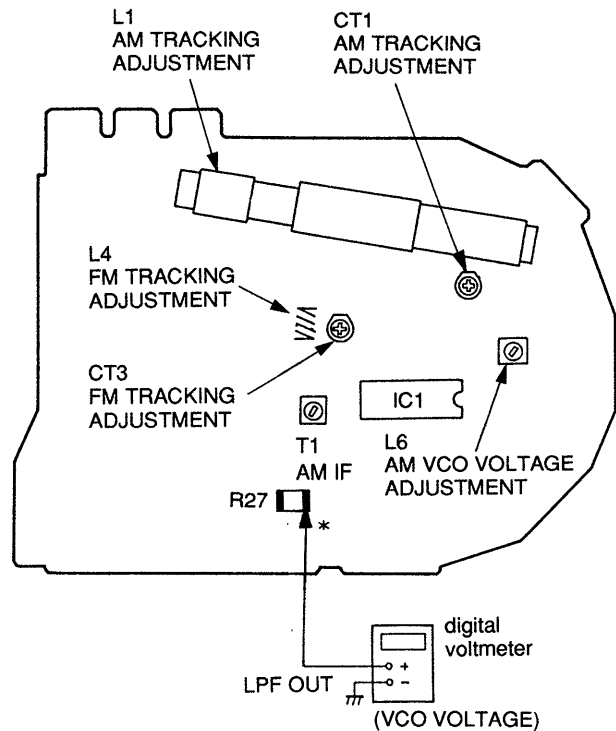

* mark is mounted on conductor side.

SECTION 4 DIAGRAMS

4-1. SEMICONDUCTOR LEAD LAYOUTS

CXA1019S

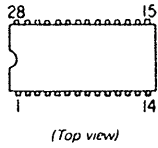

**DTZ5.1C
1T362**

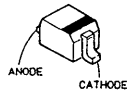

1SS184

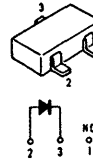

μPD1724GB-648-1P7

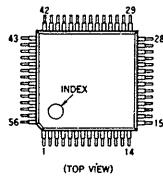

KV1560

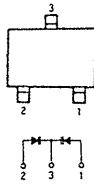

1S2836

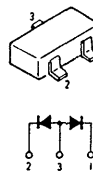

**DTA144EK
2SC1623-L5L6
2SC2223-F13**

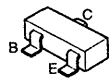

KV1563M, 3

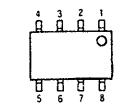

10E2

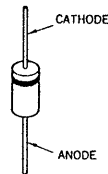

**2SA1175-HFE
2SC2785-HFE**

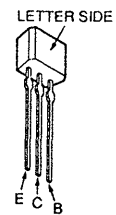

**SLH-34MCF07
1T362**

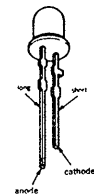

2SC2001TP-K1K2

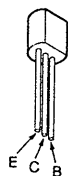

1SS119

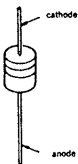

4-2. PRINTED WIRING BOARD

• Semiconductor Location

Ref. No.	Location
D1	E-11
D2	D-9
D3	D-10
D5	B-8
D6	B-7
D7	B-7
D8	B-6
D9	C-6
D10	B-6
D11	B-6
D12	B-6
D13	B-6
D14	B-6
D101	D-4
D102	D-2
D103	E-4
IC1	D-9
IC2	B-7
Q1	E-9
Q4	E-10
Q5	D-11
Q6	D-11
Q7	D-8
Q8	C-9
Q9	B-8
Q10	C-8
Q11	C-8
Q12	C-7
Q13	C-7
Q101	D-4

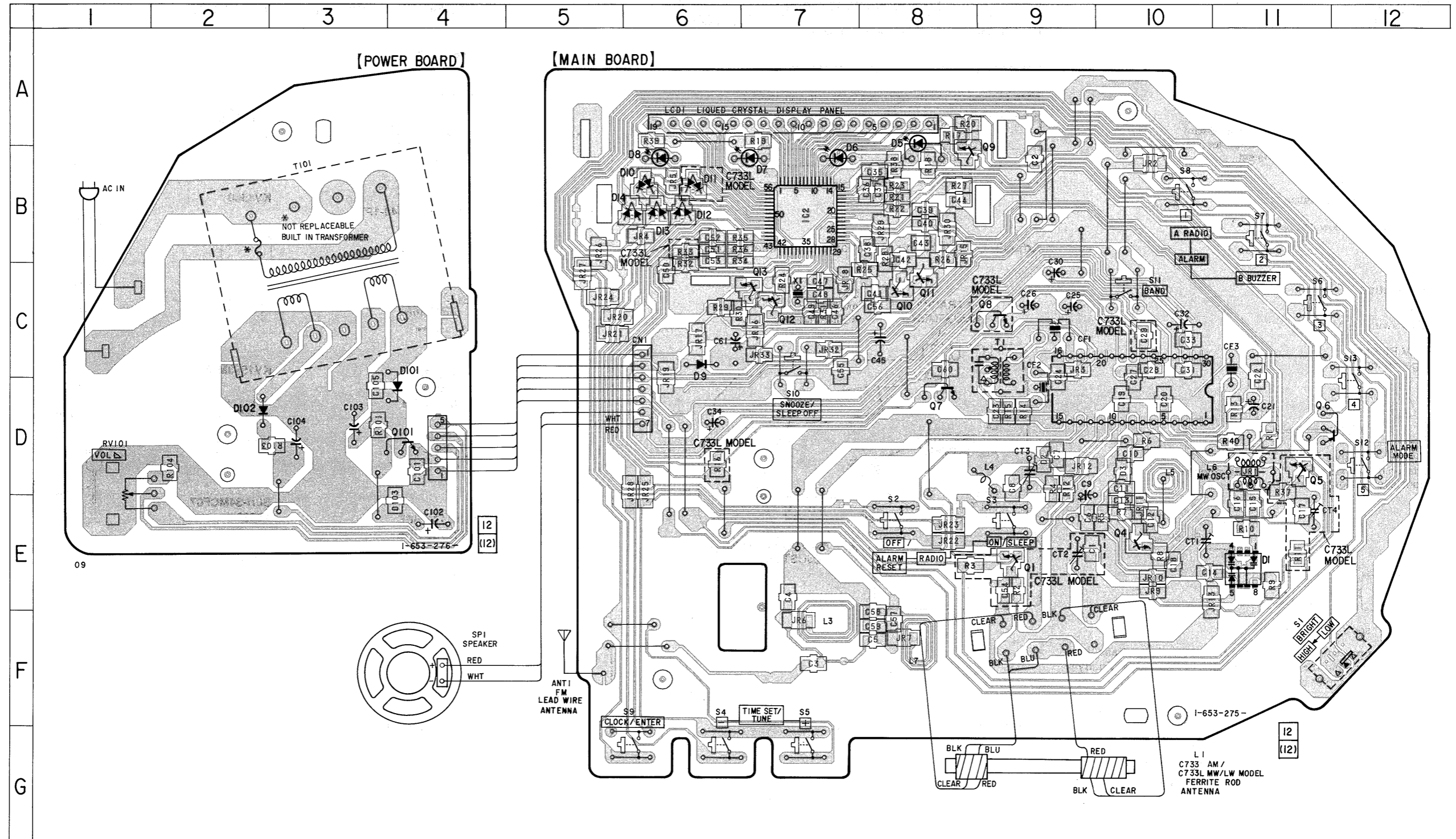

Note:

- ○ — : parts extracted from the component side.
- △ : internal component.
- [Pattern] : Pattern from the side which enable seeing.
- Abbreviation
- IT : Italian model.

• See page 14 for IC Pin Functions. (IC2)

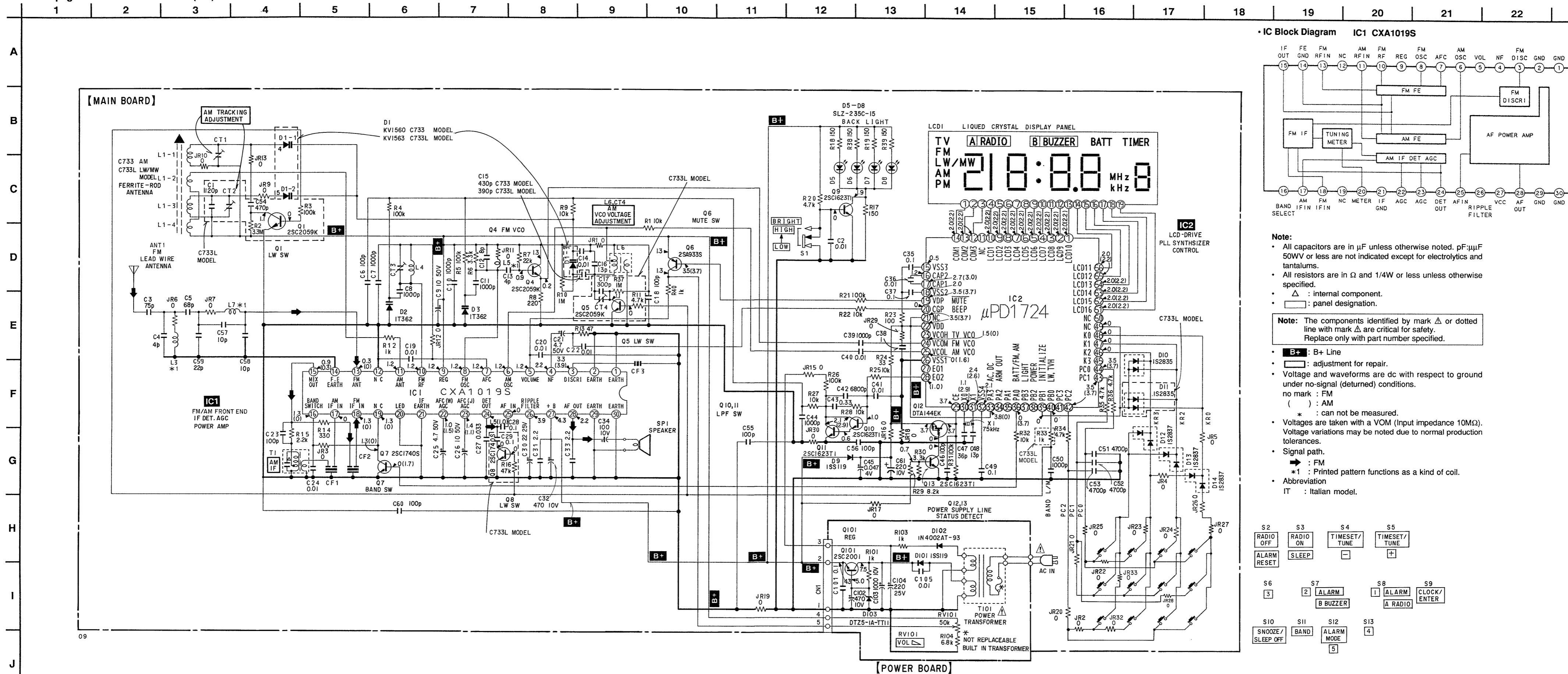

09

4-4. IC PIN FUNCTIONS

• IC2 (μ PD1724GB-648-1P7)

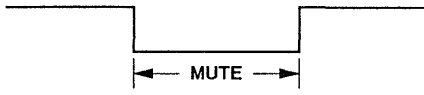
Pin No.	Pin Name	Signal Name	I/O	Description
1 – 10	LCD10 – LCD1	LCD10 – LCD1	O	LCD drive
11	NC	–	–	Not in use.
12 – 14	COM3 – COM1	COM3 – COM1	O	LCD common
15	VSS3	–	–	Pin for doubler circuit capacitor connection to develop LCD drive voltage.
16	CAP2	–		
17	CAP1	–		
18	VSS2	–		
19	VDP	$\overline{\text{MUTE}}$	O	Audio signal mute. Active : Low. LOW when MUTE ON. 
20	CGP	BEEP	O	Activates buzzer.
21	NC	–	–	Terminated to VDD
22	VDD	–	–	3V power supply input terminal.
23	VCOH	TV VCO	I	Not in use.
24	VCOM	FM VCO	I	FM VCO input.
25	VCOL	AM VCO	I	AM VCO input.
26	VSS1	–	–	GND
27	EO1	–	–	Not in use.
28	EO2	–	O	PLL error output.
29	CE	CE	I	Detects power supply line status. Power supply line OFF : Low Power supply line ON : High
30	XO	X OUT	O	Crystal oscillator connection terminal. (75kHz)
31	XI	X IN	I	
32	VSS4	–	–	Pin for regulator circuit capacitor connection to attain stable drive voltage of the oscillator.
33	PA3	AC DC	I	Terminated to VDD
34	PA2	ARM OUT	O	Not in use.
35	PA1	PA1	O	Not in use.
36	PA0	BATT/FM AM	O	BAND output. Low : FM, High : AM
37	PB3	LIGHT	–	Not in use.
38	PB2	POWER	–	Not in use.
39	PB1	INITIALIZE	O	Initialize output.
40	PB0	LW TVH	O	Band output. Low : LW, High : MW
41 – 44	PC3 – PC0	KEY SCAN	O	Conducts Key Scan. (pin ④ : Not in use.)
45 – 48	K3 – K0	KEY RET	I	Key Return input. (pin ⑤ : Not in use.)
49	NC	–	–	Terminated to initialize.
50	NC	–	–	Not in use.
51 – 56	LCD16 – LCD11	LCD16 – LCD11	O	LCD drive

SECTION 5 EXPLODED VIEWS

NOTE:

- Items marked “ * ” are not stocked since they are seldom required for routine service. Some delay should be anticipated when ordering these items.

- Color Indication of Appearance Parts Example:
KNOB, BALANCE (WHITE) . . . (RED)

↑ ↑
Parts color Cabinet's color

- -XX, -X mean standardized parts, so they may have some difference from the original one.
- The mechanical parts with no reference number in the exploded views are not supplied.
- Hardware (# mark) list and accessories and packing materials are given in the last of this parts list.
- Abbreviation
IT : Italian model

The components identified by mark Δ or dotted line with mark Δ are critical for safety. Replace only with part number specified.

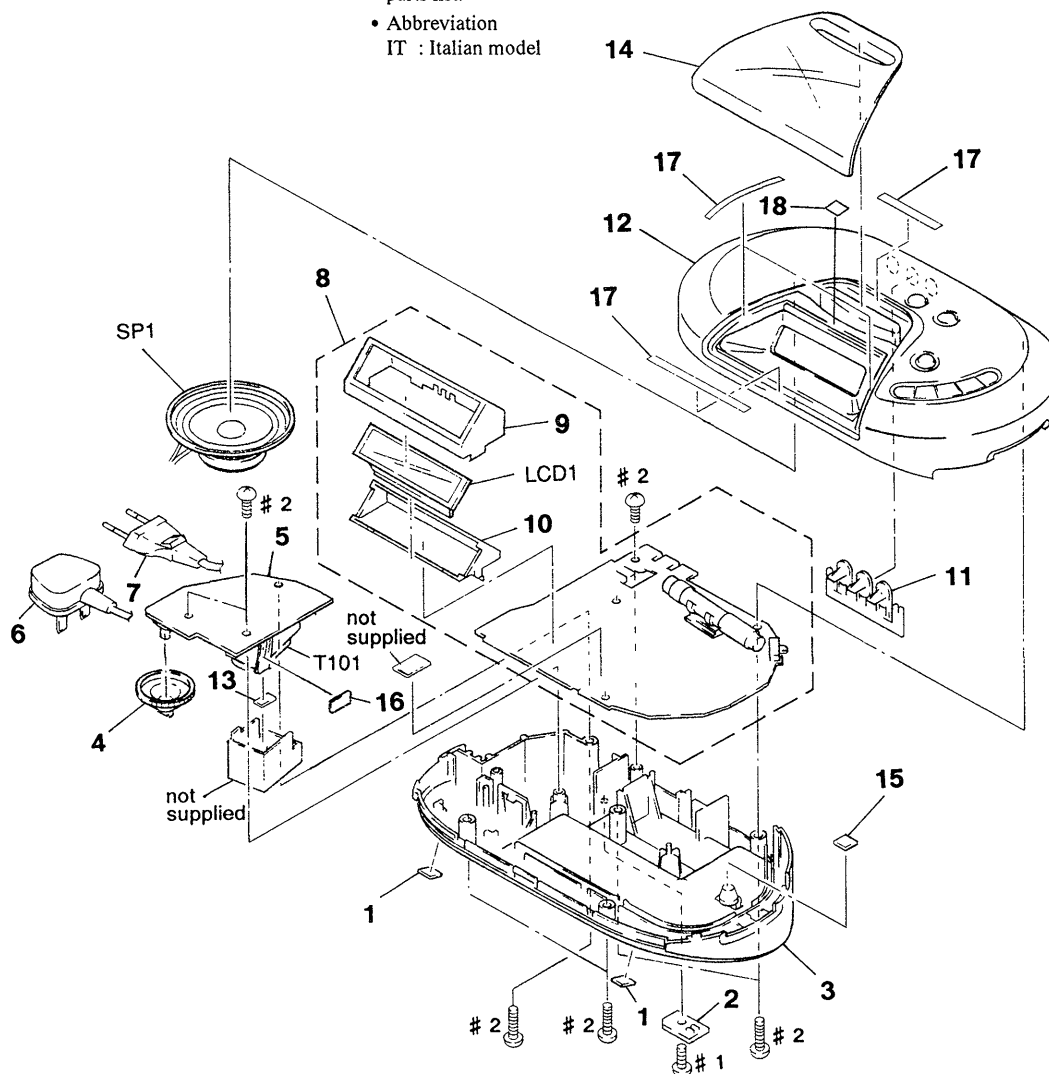

Ref. No.	Part No.	Description	Remark	Ref. No.	Part No.	Description	Remark
1	3-368-852-01	FOOT		* 10	3-914-604-01	FRAME, REFLECTION	
2	3-903-160-01	STOPPER (CODE) (BLACK)		11	3-914-600-01	BUTTON (TIME SET) (BLACK)	
2	3-903-160-11	STOPPER (CODE) (WHITE)		11	3-914-600-11	BUTTON (TIME SET) (WHITE)	
3	3-914-598-01	CABINET (LOWER) (C733) (BLACK)		12	X-3368-866-1	CABINET (UPPER) ASSY (BLACK) (C733)	
3	3-914-598-11	CABINET (LOWER) (C733) (WHITE)		12	X-3368-867-1	CABINET (UPPER) ASSY (WHITE) (C733)	
3	3-914-598-21	CABINET (LOWER) (C733L) (BLACK)		12	X-3369-062-1	CABINET (UPPER) ASSY (BLACK) (C733L)	
3	3-914-598-31	CABINET (LOWER) (C733L) (WHITE)		12	X-3369-063-1	CABINET (UPPER) ASSY (WHITE) (C733L)	
4	3-382-175-31	KNOB (V)		13	9-911-840-XX	CUSHION	
* 5	A-3662-027-A	POWER BOARD, COMPLETE		14	3-914-594-01	PLATE, TRANSPARENT	
Δ 6	1-696-572-21	CORD, POWER (BLACK) (UK)		15	3-831-441-11	CUSHION (B)	
Δ 6	1-751-112-11	CORD, POWER (WHITE) (UK)		16	3-846-067-01	SPACER C	
Δ 7	1-551-958-21	CORD, POWER (WHITE) (AEP, IT)		17	3-918-369-01	SHEET, ADHESIVE	
Δ 7	1-555-795-00	CORD, POWER (BLACK) (AEP, IT)		18	3-831-441-XX	SHEET (1)	
* 8	A-3662-024-A	MAIN BOARD, COMPLETE (C733)		LCD1	1-809-711-31	DISPLAY PANEL, LIQUID CRYSTAL	
* 8	A-3662-093-A	MAIN BOARD, COMPLETE (C733L)		SP1	1-503-082-00	SPEAKER (6.6CM)	
* 9	3-914-605-01	CASE, SHIELD		Δ T101	1-405-923-11	TRANSFORMER, POWER	

MAIN

SECTION 6 ELECTRICAL PARTS LIST

NOTE:

The components identified by mark Δ or dotted line with mark Δ are critical for safety. Replace only with part number specified.

When indicating parts by reference number, please include the board name.

- Due to standardization, replacements in the parts list may be different from the parts specified in the diagrams or the components used on the set.
- Items marked "*" are not stocked since they are seldom required for routine service. Some delay should be anticipated when ordering these items.
- -XX, -X mean standardized parts, so they may have some difference from the original one.
- Color Indication of Appearance Parts Example:
KNOB, BALANCE (WHITE) . . . (RED)

\uparrow \uparrow
 Parts color Cabinet's color
- Hardware (# mark) list and accessories and packing materials are given in the last of this parts list.
- RESISTORS
All resistors are in ohms
METAL: Metal-film resistor
METAL OXIDE: Metal Oxide-film resistor
F : nonflammable
- SEMICONDUCTORS
In each case, u: μ , for example:
uA...: μ A..., uPA...: μ PA..., uPB...: μ PB...,
uPC...: μ PC..., uPD...: μ PD...
- CAPACITORS
uF : μ F
- COILS
uH : μ H
- Abbreviation
IT: Italian model

Ref. No.	Part No.	Description	Remark	Ref. No.	Part No.	Description	Remark
*	A-3662-024-A	MAIN BOARD, COMPLETE (C733) *****		C33	1-164-505-11	CERAMIC CHIP 2.2uF	16V
*	A-3662-093-A	MAIN BOARD, COMPLETE (C733L) *****		C34	1-124-443-00	ELECT 100uF	20% 10V
*	3-914-604-01	FRAME, REFLECTION		C35	1-163-038-00	CERAMIC CHIP 0.1uF	25V
*	3-914-605-01	CASE, SHIELD		C36	1-163-031-11	CERAMIC CHIP 0.01uF	50V
		< CAPACITOR >		C37	1-163-038-00	CERAMIC CHIP 0.1uF	25V
C1	1-163-119-00	CERAMIC CHIP 120PF	5% 50V (C733L)	C38	1-164-346-11	CERAMIC CHIP 1uF	16V
C2	1-163-031-11	CERAMIC CHIP 0.01uF	50V	C39	1-163-141-00	CERAMIC CHIP 0.001uF	5% 50V
C3	1-163-114-00	CERAMIC CHIP 75PF	5% 50V	C40	1-163-031-11	CERAMIC CHIP 0.01uF	50V
C4	1-163-087-00	CERAMIC CHIP 4PF	50V	C41	1-163-031-11	CERAMIC CHIP 0.01uF	50V
C5	1-163-113-00	CERAMIC CHIP 68PF	5% 50V	C42	1-163-019-00	CERAMIC CHIP 0.0068uF	10% 50V
C6	1-163-117-00	CERAMIC CHIP 100PF	5% 50V	C43	1-164-006-11	CERAMIC CHIP 0.33uF	10% 16V
C7	1-163-141-00	CERAMIC CHIP 0.001uF	5% 50V	C44	1-163-141-00	CERAMIC CHIP 0.001uF	5% 50V
C8	1-163-141-00	CERAMIC CHIP 0.001uF	5% 50V	C45	1-125-701-11	DOUBLE LAYER 0.047F	4V
C9	1-124-907-11	ELECT 10uF	20% 50V	C46	1-163-117-00	CERAMIC CHIP 100PF	5% 50V
C10	1-163-141-00	CERAMIC CHIP 0.001uF	5% 50V	C47	1-163-106-00	CERAMIC CHIP 36PF	5% 50V
C11	1-163-141-00	CERAMIC CHIP 0.001uF	5% 50V	C48	1-163-096-00	CERAMIC CHIP 13PF	5% 50V
C12	1-163-091-00	CERAMIC CHIP 8PF	50V	C49	1-163-038-00	CERAMIC CHIP 0.1uF	25V
C13	1-163-087-00	CERAMIC CHIP 4PF	50V	C50	1-163-141-00	CERAMIC CHIP 0.001uF	5% 50V
C14	1-163-031-11	CERAMIC CHIP 0.01uF	50V	C51	1-163-029-11	CERAMIC CHIP 0.0047uF	50V
C15	1-163-131-00	CERAMIC CHIP 390PF	5% 50V (C733L)	C52	1-163-029-11	CERAMIC CHIP 0.0047uF	50V
C15	1-163-132-00	CERAMIC CHIP 430PF	5% 50V (C733)	C53	1-163-029-11	CERAMIC CHIP 0.0047uF	50V
C16	1-163-096-00	CERAMIC CHIP 13PF	5% 50V	C54	1-163-133-00	CERAMIC CHIP 470PF	5% 50V (C733L)
C17	1-163-128-00	CERAMIC CHIP 300PF	5% 50V (C733L)	C55	1-163-117-00	CERAMIC CHIP 100PF	5% 50V
C18	1-163-117-00	CERAMIC CHIP 100PF	5% 50V	C56	1-163-117-00	CERAMIC CHIP 100PF	5% 50V
C19	1-163-031-11	CERAMIC CHIP 0.01uF	50V	C57	1-163-093-00	CERAMIC CHIP 10PF	5% 50V
C20	1-163-031-11	CERAMIC CHIP 0.01uF	50V	C58	1-163-093-00	CERAMIC CHIP 10PF	5% 50V
C21	1-124-927-11	ELECT 4.7uF	20% 100V	C59	1-163-101-00	CERAMIC CHIP 22PF	5% 50V
C22	1-163-031-11	CERAMIC CHIP 0.01uF	50V	C60	1-163-117-00	CERAMIC CHIP 100PF	5% 50V
C23	1-163-117-00	CERAMIC CHIP 100PF	5% 50V	C61	1-126-176-11	ELECT 220uF	20% 10V
C24	1-164-232-11	CERAMIC CHIP 0.01uF	50V			< FILTER >	
C25	1-124-927-11	ELECT 4.7uF	20% 100V	CF1	1-577-072-21	FILTER, CERAMIC (C733)	
C26	1-124-907-11	ELECT 10uF	20% 50V	CF1	1-578-677-21	FILTER, CRYSTAL (C733L)	
C27	1-163-989-11	CERAMIC CHIP 0.033uF	10% 25V	CF2	1-567-097-61	FILTER, CERAMIC	
C28	1-163-038-00	CERAMIC CHIP 0.1uF	25V	CF3	1-567-097-61	FILTER, CERAMIC	
C29	1-163-038-00	CERAMIC CHIP 0.1uF	25V (C733L)			< CONNECTOR >	
C30	1-126-233-11	ELECT 22uF	20% 50V	* CN1	1-568-273-11	SOCKET, CONNECTOR 7P	
C31	1-164-505-11	CERAMIC CHIP 2.2uF	16V			< TRIMMER >	
C32	1-124-472-11	ELECT 470uF	20% 10V	CT1	1-141-304-21	CAP, TRIMMER 10PF	

Ref. No.	Part No.	Description	Remark	Ref. No.	Part No.	Description	Remark
CT2	1-141-443-11	TRIMMER, CERAMIC (C733L)		JR28	1-216-296-91	METAL GLAZE 0 5% 1/8W	
CT3	1-141-304-21	CAP, TRIMMER 10PF		JR29	1-216-296-91	METAL GLAZE 0 5% 1/8W	
CT4	1-141-444-11	TRIMMER, CERAMIC (C733L)		JR30	1-216-296-91	METAL GLAZE 0 5% 1/8W	
		< DIODE >		JR32	1-216-295-91	METAL GLAZE 0 5% 1/10W	
D1	8-719-023-XX	DIODE KV1563M-3 (C733L)		JR33	1-216-295-91	METAL GLAZE 0 5% 1/10W	
D1	8-719-951-05	DIODE KV1560 (C733)				< COIL >	
D2	8-713-002-79	DIODE 1T362		L1	1-402-616-11	ANTENNA, FERRITE-ROD (MW) (C733)	
D3	8-713-002-79	DIODE 1T362		L1	1-501-715-11	ANTENNA, FERRITE-ROD (LW/MW) (C733L)	
D5	8-719-037-81	DIODE SLH-34MCF07		L4	1-406-545-11	COIL, AIR-CORE	
D6	8-719-037-81	DIODE SLH-34MCF07		L6	1-406-485-11	COIL (OSC)	
D7	8-719-037-81	DIODE SLH-34MCF07				< LIQUID CRYSTAL DISPLAY >	
D8	8-719-037-81	DIODE SLH-34MCF07		LCD1	1-809-711-31	DISPLAY PANEL, LIQUID CRYSTAL	
D9	8-719-911-19	DIODE 1SS119				< TRANSISTOR >	
D10	8-719-104-34	DIODE 1S2836		Q1	8-729-102-07	TRANSISTOR 2SC2223-F13 (C733L)	
D11	8-719-104-34	DIODE 1S2836 (C733L)		Q4	8-729-102-07	TRANSISTOR 2SC2223-F13	
D12	8-719-801-78	DIODE 1SS184		Q5	8-729-102-07	TRANSISTOR 2SC2223-F13 (C733L)	
D13	8-719-801-78	DIODE 1SS184		Q6	8-729-119-76	TRANSISTOR 2SA1175-HFE	
D14	8-719-801-78	DIODE 1SS184		Q7	8-729-119-78	TRANSISTOR 2SC2785-HFE	
		< IC >		Q8	8-729-119-78	TRANSISTOR 2SC2785-HFE (C733L)	
IC1	8-752-035-29	IC CXA1019S		Q9	8-729-120-28	TRANSISTOR 2SC1623-L5L6	
IC2	8-759-184-36	IC uPD1724GB-648-1P7		Q10	8-729-120-28	TRANSISTOR 2SC1623-L5L6	
		< JUMPER RESISTOR >		Q11	8-729-120-28	TRANSISTOR 2SC1623-L5L6	
JR1	1-216-295-91	METAL GLAZE 0 5% 1/10W		Q12	8-729-901-06	TRANSISTOR DTA144EK	
JR2	1-216-296-91	METAL GLAZE 0 5% 1/8W		Q13	8-729-120-28	TRANSISTOR 2SC1623-L5L6	
JR3	1-216-295-91	METAL GLAZE 0 5% 1/10W				< RESISTOR >	
JR4	1-216-295-91	METAL GLAZE 0 5% 1/10W		R1	1-216-073-00	METAL CHIP 10K 5% 1/10W	
JR5	1-216-295-91	METAL GLAZE 0 5% 1/10W		R2	1-216-133-00	METAL CHIP 3.3M 5% 1/10W (C733L)	
JR6	1-216-296-91	METAL GLAZE 0 5% 1/8W		R3	1-216-097-00	METAL CHIP 100K 5% 1/10W (C733L)	
JR7	1-216-296-91	METAL GLAZE 0 5% 1/8W		R4	1-216-097-00	METAL CHIP 100K 5% 1/10W	
JR9	1-216-295-91	METAL GLAZE 0 5% 1/10W		R5	1-216-097-00	METAL CHIP 100K 5% 1/10W	
JR10	1-216-295-91	METAL GLAZE 0 5% 1/10W		R6	1-216-061-00	METAL CHIP 3.3K 5% 1/10W	
JR11	1-216-295-91	METAL GLAZE 0 5% 1/10W		R7	1-216-081-00	METAL CHIP 22K 5% 1/10W	
JR12	1-216-296-91	METAL GLAZE 0 5% 1/8W		R8	1-216-033-00	METAL CHIP 220 5% 1/10W	
JR13	1-216-296-91	METAL GLAZE 0 5% 1/8W		R9	1-216-073-00	METAL CHIP 10K 5% 1/10W	
JR15	1-216-295-91	METAL GLAZE 0 5% 1/10W		R10	1-216-121-00	METAL CHIP 1M 5% 1/10W	
JR16	1-216-296-91	METAL GLAZE 0 5% 1/8W		R11	1-216-065-00	METAL CHIP 4.7K 5% 1/10W (C733L)	
JR17	1-216-296-91	METAL GLAZE 0 5% 1/8W		R12	1-216-049-00	METAL CHIP 1K 5% 1/10W	
JR18	1-216-295-91	METAL GLAZE 0 5% 1/10W		R13	1-216-017-00	METAL CHIP 47 5% 1/10W	
JR19	1-216-296-91	METAL GLAZE 0 5% 1/8W		R14	1-216-037-00	METAL CHIP 330 5% 1/10W	
JR20	1-216-296-91	METAL GLAZE 0 5% 1/8W		R15	1-216-057-00	METAL CHIP 2.2K 5% 1/10W	
JR21	1-216-296-91	METAL GLAZE 0 5% 1/8W		R16	1-216-089-91	METAL GLAZE 47K 5% 1/10W (C733L)	
JR22	1-216-296-91	METAL GLAZE 0 5% 1/8W		R17	1-216-029-00	METAL CHIP 150 5% 1/10W	
JR23	1-216-296-91	METAL GLAZE 0 5% 1/8W		R18	1-216-029-00	METAL CHIP 150 5% 1/10W	
JR24	1-216-296-91	METAL GLAZE 0 5% 1/8W		R19	1-216-029-00	METAL CHIP 150 5% 1/10W	
JR25	1-216-296-91	METAL GLAZE 0 5% 1/8W		R20	1-216-065-00	METAL CHIP 4.7K 5% 1/10W	
JR26	1-216-296-91	METAL GLAZE 0 5% 1/8W					
JR27	1-216-296-91	METAL GLAZE 0 5% 1/8W					

MAIN

POWER

Ref.No.	Part No.	Description	Remark
R21	1-216-097-00	METAL CHIP 100K 5% 1/10W	
R22	1-216-073-00	METAL CHIP 10K 5% 1/10W	
R23	1-216-025-00	METAL CHIP 100 5% 1/10W	
R24	1-216-013-00	METAL CHIP 33 5% 1/10W	
R25	1-216-073-00	METAL CHIP 10K 5% 1/10W	
R26	1-216-097-00	METAL CHIP 100K 5% 1/10W	
R27	1-216-073-00	METAL CHIP 10K 5% 1/10W	
R28	1-216-073-00	METAL CHIP 10K 5% 1/10W	
R29	1-216-071-00	METAL CHIP 8.2K 5% 1/10W	
R30	1-216-061-00	METAL CHIP 3.3K 5% 1/10W	
R31	1-216-097-00	METAL CHIP 100K 5% 1/10W	
R32	1-216-073-00	METAL CHIP 10K 5% 1/10W	
R33	1-216-049-00	METAL CHIP 1K 5% 1/10W (C733L)	
R34	1-216-065-00	METAL CHIP 4.7K 5% 1/10W	
R35	1-216-065-00	METAL CHIP 4.7K 5% 1/10W	
R36	1-216-065-00	METAL CHIP 4.7K 5% 1/10W	
R37	1-216-121-00	METAL CHIP 1M 5% 1/10W (C733L)	
R38	1-216-029-00	METAL CHIP 150 5% 1/10W	
R39	1-216-029-00	METAL CHIP 150 5% 1/10W	
R40	1-216-049-00	METAL CHIP 1K 5% 1/10W	
< SWITCH >			
S1	1-571-478-11	SWITCH, SLIDE (BRIGHT)	
S2	1-554-937-11	SWITCH, KEY BOARD (RADIO OFF/ALARM RESET)	
S3	1-554-937-11	SWITCH, KEY BOARD (RADIO ON/SLEEP)	
S4	1-554-937-11	SWITCH, KEY BOARD (TIME SET/TUNE -)	
S5	1-554-937-11	SWITCH, KEY BOARD (TIME SET/TUNE +)	
S6	1-554-937-11	SWITCH, KEY BOARD (3)	
S7	1-554-937-11	SWITCH, KEY BOARD (2/ALARM B BUZZER)	
S8	1-554-937-11	SWITCH, KEY BOARD (1/ALARM A RADIO)	
S9	1-554-937-11	SWITCH, KEY BOARD (CLOCK/ENTER)	
S10	1-554-937-11	SWITCH, KEY BOARD (SNOOZE/SLEEP OFF)	
S11	1-554-937-11	SWITCH, KEY BOARD (BAND)	
S12	1-554-937-11	SWITCH, KEY BOARD (5/ALARM MODE)	
S13	1-554-937-11	SWITCH, KEY BOARD (4)	
< TRANSFORMER >			
T1	1-404-790-11	TRANSFORMER, IF (C733)	
T1	1-404-902-21	TRANSFORMER, IF (C733L)	
< VIBRATOR >			
X1	1-567-769-11	VIBRATOR, CRYSTAL (75kHz)	

*	A-3662-027-A	POWER BOARD, COMPLETE *****	
< CAPACITOR >			
C101	1-163-038-00	CERAMIC CHIP 0.1uF	25V

Ref.No.	Part No.	Description	Remark
C102	1-124-472-11	ELECT 470uF	20% 10V
C103	1-126-926-11	ELECT 1000uF	20% 10V
C104	1-124-120-11	ELECT 220uF	20% 25V
C105	1-163-031-11	CERAMIC CHIP 0.01uF	50V
< DIODE >			
D101	8-719-200-02	DIODE 10E2	
D102	8-719-911-19	DIODE 1SS119	
D103	8-719-977-00	DIODE DTZ5.1C	
< TRANSISTOR >			
Q101	8-729-011-92	TRANSISTOR 2SC2001TP-K1K2	
< RESISTOR >			
R101	1-216-049-00	METAL CHIP 1K 5%	1/10W
R103	1-216-049-00	METAL CHIP 1K 5%	1/10W
R104	1-216-069-00	METAL CHIP 6.8K 5%	1/10W
< VARIABLE RESISTOR >			
RV101	1-241-542-11	RES, VAR, CRABON (VOL ∇)	
< TRANSFORMER >			
Δ T101	1-450-923-11	TRANSFORMER, POWER	
< TERMINAL >			
* TM101	1-535-771-11	TERMINAL	
* TM102	1-535-771-11	TERMINAL	

MISCELLANEOUS *****			
Δ 6	1-696-572-21	CORD, POWER (BLACK) (UK)	
Δ 6	1-751-112-11	CORD, POWER (WHITE) (UK)	
Δ 7	1-551-958-21	CORD, POWER (WHITE) (AEP, IT)	
Δ 7	1-555-795-00	CORD, POWER (BLACK) (AEP, IT)	
LCD1	1-809-711-31	DISPLAY PANEL, LIQUID CRYSTAL	
SP1	1-503-082-00	SPEAKER (6.6CM)	
Δ T101	1-405-923-11	TRANSFORMER, POWER	

The components identified by mark Δ or dotted line with mark Δ are critical for safety. Replace only with part number specified.

<u>Ref. No.</u>	<u>Part No.</u>	<u>Description</u>	<u>Remark</u>
		ACCESSORIES & PACKING MATERIALS *****	
	1-501-499-11	COUPLER, ANTENNA (C733:AEP/C733L:AEP, UK)	
	3-759-077-11	MANUAL, INSTRUCTION (AEP, UK) (ENGLISH, FRENCH, GERMAN, SPANISH)	
	3-759-077-41	MANUAL, INSTRUCTION (AEP, IT, UK) (DUTCH, SWEDISH, ITALIAN, PORTUGUESE)	
*	3-916-625-01	INDIVIDUAL CARTON (C733)	
*	3-917-962-01	INDIVIDUAL CARTON (C733L)	

		***** HARDWARE LIST *****	
#1	7-685-647-79	SCREW +P 3X10 TYPE2 NON-SLIT	
#2	7-685-649-79	SCREW +P 3X14 TYPE2 NON-SLIT	

