

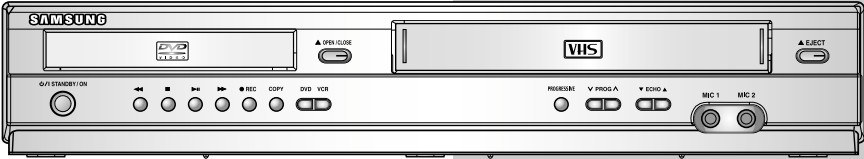

Instruction Manual

DVD-V940K



Remote Control Overview



Contents

◆ Foreword		
Safety Instructions	3	
Disc Type and Characteristics	4	
◆ DVD-VCR Overviews		
Front View of the DVD-VCR	5	
Rear View of the DVD-VCR	5	
Accessories	5	
Display Indicators	6	
◆ Connecting Your DVD-VCR		
Inserting Batteries in the Remote Control	6	
Connecting DVD-VCR to the TV using the Coaxial Cable	6	
Connecting DVD-VCR to the TV using the A/V Cable	7	
Connecting DVD-VCR to a Satellite Receiver or Other Equipment	7	
Plug & Auto Set up	8	
Basic TV Tuner Operations	8	
Tuning Your Television for the DVD-VCR	9	
Deck Control Keys	9	
Copying from DVD to VCR	10	
Setting the Date and Time	10	
◆ Setting Up Your DVD-VCR		
Presetting the Stations Automatically	11	
Presetting the Stations Manually	12	
Clearing a Preset Station	13	
Changing the Preset Station Table	13	
Selecting the RF OUT Sound Mode (G-K)	14	
Setting the DVD-VCR Output Channel	14	
Selecting the Colour Mode	15	
NICAM	15	
Intelligent Picture Control	16	
Auto Power off	16	
Screen Messages	16	
Selecting the Cassette Type	17	
Repeat Play	17	
◆ Recording Television Broadcasts		
Selecting the Recording Speed	17	
S-VHS Play	17	
Recording a Programme Immediately	18	
Protecting a Recorded Cassette	18	
Recording a Programme with Automatic Stop	18	
Using the Timer Programming Feature	19	
Checking a Preset Recording	19	
Cancelling a Preset Recording	20	
◆ Playing Back		
Playing a Cassette	20	
Adjusting Picture Alignment Manually	20	
Selecting the Audio Output Mode	20	
Playing a Cassette in Slow Motion	21	
Playing a Sequence Frame by Frame	21	
Playing a Sequence at Variable Speeds	21	
Searching for a Specific Sequence	21	
Using the Tape Counter	22	
Using the Assemble Edit Function	23	
Recording from Another VCR or Camcorder	23	
◆ KARAOKE Functions (VCR)		
Using the KARAOKE Function	24	
SCORE Function	24	
KARAOKE SEARCH Function	24	
◆ DVD Functions		
Choosing a Connection	25	
Setting Up the Language Features	25	
Setting Up the Audio Options	27	
Setting Up the Display Options	28	
Setting Up the Parental Control	29	
Special Playback Features	30	
A/V Receiver Connections	30	
Adjusting the Aspect Ratio (EZ View)	31	
Using the Display Function	32	
Changing the Camera Angle	33	
Selecting the Subtitle Language	33	
Repeat Play	34	
Selecting the Audio Language	34	
Using the Mark Function	35	
MP3/WMA Play	36	
Program Play & Random Play	37	
Picture CD Playback	38	
DivX/XviD/MPEG4 Special Playback Features	39	
DivX/XviD/MPEG4 Playback	40	
◆ KARAOKE Functions (DVD)		
Beginning Karaoke Functions	41	
Key Control	41	
Reserving a Song	41	
Cancellation of reservation	42	
Vocal Fader	42	
Guide Melody	42	
Score Function	42	
Types of Karaoke disc	42	
◆ Solving Problems		
Technical Specifications	43	
Problems and Solutions (VCR)	44	
Troubleshooting Guide (DVD)	45	

Safety Instructions

The following illustrations represent precautions.



The lightning bolt is a warning sign alerting you to dangerous voltage inside the product.

DO NOT OPEN THE DVD-VCR. Refer to service personnel.

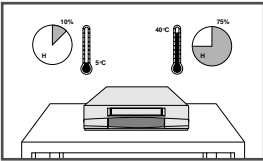

Do NOT expose the DVD-VCR to extreme temperature conditions (below 5°C and above 40°C) or to extreme humidity conditions (less than 10% and more than 75%).

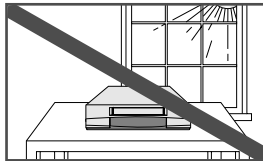

Do NOT expose the DVD-VCR to direct sunlight.

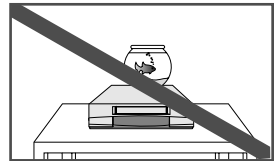

Do NOT expose the DVD-VCR to any liquids.

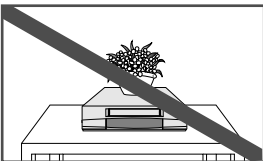

Do NOT place any objects on the DVD-VCR or remote control.

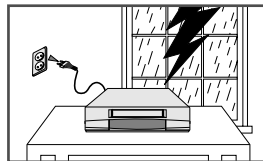

During a storm and/or lightning, unplug the DVD-VCR from the mains socket and aerial.

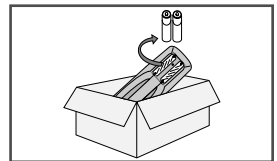

If the remote control is not used for a long period of time, remove the batteries and store it in a cool, dry place.



THIS DEVICE IS NOT FOR USE IN INDUSTRIAL ENVIRONMENTS

This product incorporates copyright protection technology that is protected by method claims of certain U.S. patents and other intellectual property rights owned by Macrovision Corporation and other rights owners.

Use of this copyright protection technology must be authorized by Macrovision Corporation, and is intended for home and other limited viewing uses only unless otherwise authorized by Macrovision Corporation. Reverse engineering or disassembly is prohibited.

Disc Type and Characteristics

This DVD player is capable of playing the following types of discs with the corresponding logos :





Disc Types (Logos)	Recording Types	Disc Size	Max. Playing Time	Characteristics
DVD 	Audio + Video	12 Cm	Single-sided 240 min. Double-sided 480 min.	<ul style="list-style-type: none"> • DVD contains excellent sound and video due to Dolby Digital and MPEG-2 system. • Various screen and audio functions can be easily selected through the on-screen menu.
		8 Cm	Single-sided 80 min. Double-sided 160 min.	
VIDEO-CD 	Audio + Video	12 Cm	74 min.	<ul style="list-style-type: none"> • Video with CD sound, VHS quality & MPEG-1 compression technology.
		8 Cm	20 min.	
AUDIO-CD 	Audio	12 Cm	74 min.	<ul style="list-style-type: none"> • An LP is recorded as an analog signal with more distortion. CD is recorded as a Digital Signal with better audio quality, less distortion and less deterioration of audio quality over time.
		8 Cm	20 min.	

* DO NOT play CD-ROM, CD-I and DVD-ROM in this player!

(CDGs play audio only, not graphics.)

* It may not be to play CD-R,CD-RW and DVD-R in all cases due to the type of disc or condition of the recording.

Disc Markings

	• Play Region Number
PAL	• PAL colour system in Australia, Newzealand, etc.
NTSC	• NTSC broadcast system in U.S.A, Canada, Korea, Japan, etc.
	• Dolby Digital disc
STEREO	• Stereo disc
DIGITAL SOUND	• Digital Audio disc
	• DTS disc
	• Disc contains a Divx software product

Play Region Number

Both the DVD player and the discs are coded by region. These regional codes must match in order for the disc to play. If the codes do not match, the disc will not play.

The Region Number for this player is described on the rear panel of the player.

Progressive Scan Outputs (525p/625p)

"Consumers should note that not all high definition television sets are fully compatible with this product and may cause artifacts to be displayed in the picture, in case of 525 or 625 progressive scan picture problems, it is recommended that the user switch the connection to the 'STANDARD DEFINITION' output. If there are questions regarding our TV set compatibility with this model 525p and 625P DVD player, please contact our customer service center."

Front View of the DVD-VCR

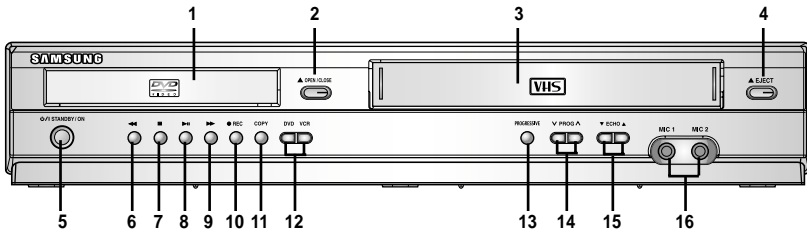

- | | | |
|------------------------------|----------------------------|------------------------------|
| 1 DVD DECK | 7 STOP BUTTON | 13 PROGRESSIVE BUTTON |
| 2 OPEN / CLOSE BUTTON | 8 PLAY / STILL BUTTON | 14 PROGRAME SELECTION BUTTON |
| 3 VIDEO CASSETTE COMPARTMENT | 9 F.F / SKIP NEXT BUTTON | 15 ECHO BUTTON |
| 4 EJECT BUTTON | 10 RECORD BUTTON | 16 MIC JACK |
| 5 D/V STANDBY/ON | 11 COPY BUTTON | |
| 6 REW / SKIP BACK BUTTON | 12 DVD / VCR SELECT BUTTON | |

Rear View of the DVD-VCR

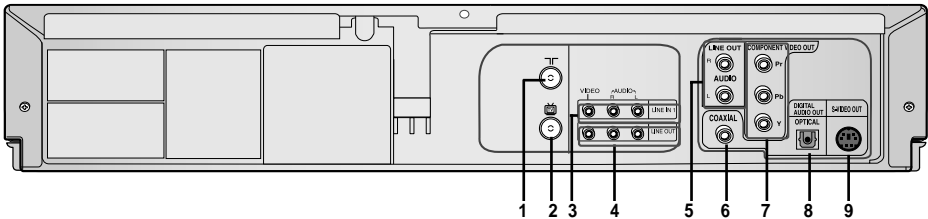

- | | | |
|------------------------------|--|---|
| 1 RF ANTENNA INPUT | 5 AUDIO LINE OUT TO TV
(S-VIDEO OR COMPONENT) | 7 COMPONENT VIDEO OUT |
| 2 RF OUT TO TV | 6 DIGITAL AUDIO OUT SOCKET
(COAXIAL) | 8 DIGITAL AUDIO OUT SOCKET
(OPTICAL) |
| 3 LINE IN 1 | | 9 S-VIDEO OUT JACK |
| 4 LINE OUT TO TV (COMPOSITE) | | |

Accessories

*You have just purchased a SAMSUNG Video Cassette Recorder (DVD-VCR).
Together with your DVD-VCR, you will find the following accessories in the box.*

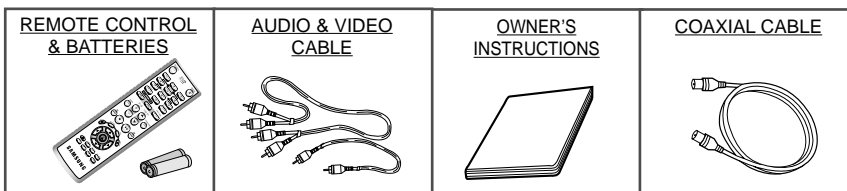

Display Indicators

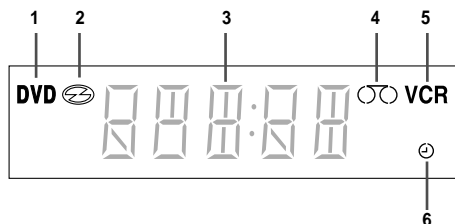

- 1 The DVD Deck is active
- 2 A DVD, CD, VCD, or SVCD is loaded
- 3 The time, counter position, time remaining or current deck status is displayed
- 4 VHS tape is inserted
- 5 The VCR Deck is active
- 6 A Timer Recording is programmed or in progress.

Inserting Batteries in the Remote Control

You must insert or replace the batteries in the remote control when you:

- ◆ Purchase the DVD-VCR
- ◆ Find that the remote control is no longer working correctly

- 1 Push the tab in the direction of the arrow to release the battery compartment cover on the rear of the remote control.
- 2 Insert two AAA, RO3 or equivalent batteries, taking care to respect the polarities:
 - ◆ + on the battery with + on the remote control
 - ◆ - on the battery with - on the remote control
- 3 Replace the cover by aligning it with the base of the remote control and pushing it back into place.

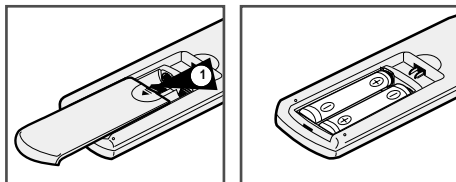



➤ Do not mix different battery types (manganese and alkaline for example).

Connecting DVD-VCR to the TV using the Coaxial Cable

To receive television programmes a signal must be received from one of the following sources:

- ◆ An outdoor aerial
- ◆ An indoor aerial
- ◆ A cable television network
- ◆ A satellite receiver

✎ Make sure that both the television and the DVD-VCR are switched off before connecting the cables.

- 1 Remove the aerial or network input cable from the television.
- 2 Connect this cable to the 75Ω coaxial socket marked  on the rear of your DVD-VCR.
- 3 Plug the coaxial cable supplied into the  socket on your DVD-VCR.
- 4 Plug the other end of the coaxial cable into the connector previously used for the aerial on the television.
- 5 To obtain better quality pictures and sound on your television, you can also connect your DVD-VCR to the television via the A/V cable (see next page) if your television is equipped with this type of connection.

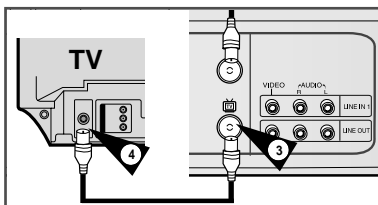
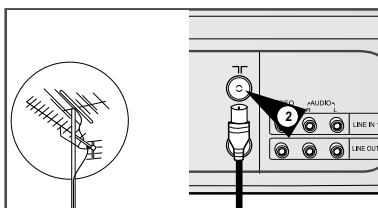

Connecting DVD-VCR to the TV using the A/V Cable

You can connect your DVD-VCR to the television using the A/V cable if the appropriate input is available on the television. You thus:

- ◆ Obtain better quality sound and pictures
- ◆ Simplify the setting up procedure of your DVD-VCR

☞ Regardless of the type of connection chosen, you must always connect the coaxial cable supplied. Otherwise, no picture will be visible on the screen when the DVD-VCR is switched off.

☞ Make sure that both the television and the DVD-VCR are switched off before connecting the cables.

- 1 Connect the coaxial cable as indicated on page 6.
- 2 Connect one end of the Audio/Video cable to the Video output and Audio L, R output socket on the rear of the DVD-VCR.
- 3 Plug the other end into the appropriate connector on the television.
- 4 To view DVD-VCR, you must select AV mode on your TV.

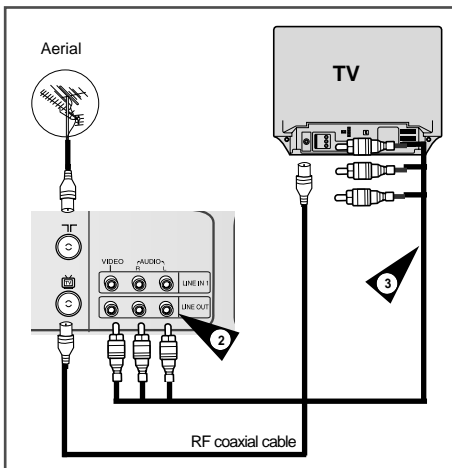

Connecting DVD-VCR to a Satellite Receiver or Other Equipment

You can connect other audio and/or video equipment to your DVD-VCR in different ways. The following illustrations give a few examples of the connection possibilities.

➤ The AV input/output connectors on the rear of the DVD-VCR are used for equipment, such as camcorders, VCRs or sound systems.

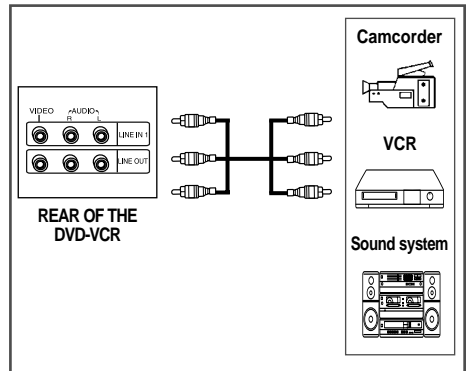

Plug & Auto Set up

Your DVD-VCR will automatically set itself up when it is plugged into the mains for the first time. TV stations will be stored in memory. The process takes a few minutes. Your DVD-VCR will then be ready for use.

- 1 Connect the coaxial cable as indicated on page 6. (Connecting Your DVD-VCR to the TV Using the Coaxial Cable)
- 2 Plug the DVD-VCR into the mains.
Result: The **Language Set** menu is displayed.

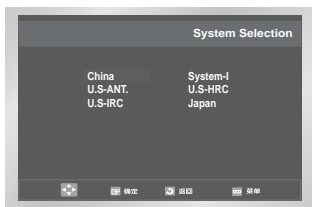

- 3 **Set menu Language**
Place the selection arrow next to your desired Language, then press the **确定(OK)** button.
- 4 Press OK to store the language selected.
Result: The System Selection menu is displayed.
- 5 Press the corresponding **▲**, **▼** or **◀**, **▶** buttons to select the your System Selection.
- 6 Press OK to start the auto scanning.
 - ◆ The number of stations automatically stored by the VCR depends on the number of stations that it has found.
- 7 The current time and date are displayed automatically. Check the date and time. if it is :
 - ◆ Correct, Press **返回(RETURN)** button twice to exit the menu.
 - ◆ incorrect, see page 10.

➤ *Auto preset can be performed by pressing **■** on the front panel continuously for 5 seconds or more with no tape inserted in VCR mode.*

Basic TV Tuner Operations

The following buttons are used when watching television via the DVD-VCR's built-in TV tuner.

- 1 **节目/磁迹跟踪(PROG ^/V) Button**
Press to change to the next or previous channel.
- 2 **0-9 Buttons**
Press to select channels directly.
- 3 **显示(INFO.)**
Press to display the channel you are watching.
 - ◆ Also works in DVD and VCR mode.

Tuning Your Television for the DVD-VCR

You must tune your television for the DVD-VCR only if you are not using a A/V cable.

➤ *To view pictures from your DVD-VCR when a A/V cable is used, the television must be set to the audio/video mode (AV).*

- 1 Switch on the television.
- 2 Switch on the DVD-VCR by pressing 待机(STANDBY/ON) on the front of the DVD-VCR or 待机(STANDBY/ON) on the remote control.
- 3 Select a programme position on the television to be reserved for use with your DVD-VCR.
- 4 Insert the video cassette in the DVD-VCR. Check that the DVD-VCR starts reading the cassette; if not, press ►|| button.
- 5 Start a scan on your television or set the television to UHF channel 36.
- 6 Fine tune the television until the pictures and sound are obtained clearly.
- 7 If you cannot find the pictures and sound, or there is interference from nearby channels, it may be necessary to change the setting of the DVD-VCR output channel (see Setting the DVD-VCR Output Channel on page 14 and Problems and Solutions on page 44).
- 8 When the picture and sound are perfectly clear, store this channel at the desired programme position on the television.
Result: That programme is now reserved for use with your DVD-VCR.

Deck Control Keys

The DVD-VCR uses one set of controls to operate both decks. The following keys are helpful in successfully controlling each deck.

- 1 **待机(STANDBY/ON) Button**
Press the 待机(STANDBY/ON) button on the remote control or front panel to turn on the DVD-VCR.
- 2 **DVD Button**
Press the DVD button on the remote control when you want to control the DVD deck.
 - ◆ The DVD indicator will light on the Front Panel Display to show that the DVD deck is selected.
- 3 **VCR Button**
Press the VCR button on remote control when you want to control the VCR deck.
 - ◆ The VCR indicator will light on the Front Panel Display to show that VHS deck is selected.
- 4 **输入选择(INPUT SEL.) Button**
Press the 输入选择(INPUT SEL.) button repeatedly to cycle through all of your input sources, including the Tuner (PR##), Line 1 (rear AV input).

➤ *Before using the VCR operation of 11~23 pages, press the VCR button on the remote control to select VCR mode.*

Before using the DVD operation of 25~40 pages, press the DVD button on the remote control to select and watch DVD.

Copying from DVD to VCR

The DVD-VCR allows you to copy the contents of a DVD to a VHS tape with a press of the COPY button.



If the DVD you are attempting to copy is copy protected, you will not be able to copy the disc. It is not permitted to copy Macrovision® encoded DVDs.

1 Insert Disc

Insert the disc you wish to copy in the DVD deck and close the drawer.

2 Insert VHS Tape

Insert a blank VHS videotape into the VCR deck.

3 Copy the DVD to VHS Tape

Press the COPY button on the DVD-VCR front panel.

- ◆ The DVD will go into Play mode and the VCR will go into Record mode.
- ◆ If the DVD disc menu appears, you may need to press the PLAY button manually to begin copying.

4 Stop the Copy Process

When the DVD is finished playing, press the VCR button on the remote control and then press the STOP button to end the copy.

- ◆ You must stop the Copy process manually when the DVD movie ends or the DVD may replay and record over and over again.

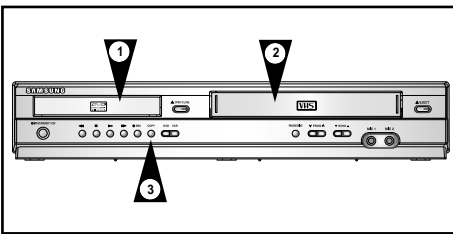

Setting the Date and Time

Your DVD-VCR contains a 24-hour clock and calendar used to:

- ◆ Automatically stop programme recording
- ◆ Preset your DVD-VCR to record a programme automatically

You must set the date and time when:

- ◆ You purchase the DVD-VCR



- ◆ Do not forget to reset the time when you change clocks from winter to summer time and vice versa.

- 1 After pressing the 菜单(MENU), press the 确定(OK) or ►.

Result: The Setup menu is displayed.

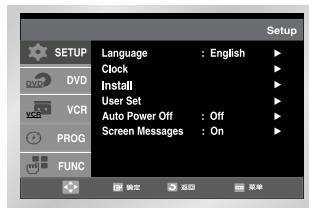

- 2 Press the corresponding ▲, ▼ buttons to select the **Clock** option.

- 3 Press the 确定(OK) or ► to select this option.

Result: The **Clock Set** menu is displayed.



- 4 Press ◀ or ▶ to select the hour, minutes, day, month and year.

Result: The option selected highlight.

- 5 Press the ▲ or ▼ buttons to increase or decrease the value.

Result: The day of the week is displayed automatically.

- You can hold the ▲, ▼ buttons down to scroll more quickly through the values.

- 6 On completion, press 返回(RETURN) to exit the menu.

Presetting the Stations Automatically

☞ You do not need to preset the stations if you have already set them automatically (see Plug & Auto Set Up on page 8).

Your DVD-VCR contains a built-in tuner used to receive television broadcasts.

You must preset the stations received through the tuner. This can be done:

- ◆ Plug & Auto Set up (see page 8)
- ◆ Automatically
- ◆ Manually (see page 12)

You can store up to 80 stations.

- 1 After pressing the 菜单(MENU), press the 确定(OK) or ▶.

Result: The Setup menu is displayed.

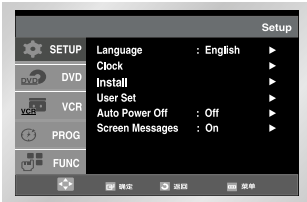

- 2 Press the corresponding ▲, ▼ buttons to select the **Install** option.
- 3 Press the 确定(OK) or ▶ to select this option.

Result: The **Install** menu is displayed.

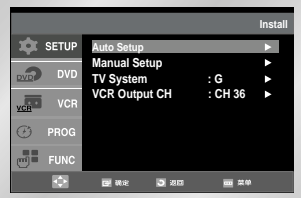

- 4 Press the corresponding ▲, ▼ buttons, until the **Auto Setup** is selected. And then press the 确定(OK) or ▶ to select this option.
Result: The System Selection menu is displayed.
- 5 Press the corresponding ▲, ▼ or ◀, ▶ buttons to select the your System Selection.
- 6 Press 确定(OK) to start the auto scanning.

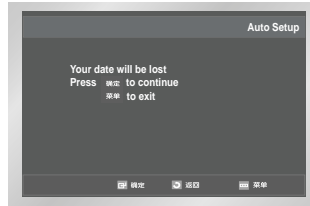

Result: ◆ The **Please Wait** indication highlight on the television screen.

- ◆ The first frequency band is scanned and the first station found is stored.
- ◆ The DVD-VCR then searches for the second station and so on.
- ◆ When the automatic scanning procedure has finished, the DVD-VCR switches automatically to programme 1.

➤ The number of stations automatically stored by the DVD-VCR depends on the number of stations that it has found.

- 7 If you wish to cancel the auto scanning before the end, press the 菜单(MENU) button to exit the menu.

➤ *Once the auto scanning procedure has finished, some stations may have been stored more than once; select the stations with the best reception and delete the ones no longer required. (See page 13)*

Presetting the Stations Manually

 You do not need to preset the stations manually if you have already set them automatically.

- After pressing the 菜单(MENU), press the 确定(OK) or ►.
- Result: The Setup menu is displayed.
- Press the corresponding ▲, ▼ buttons to select the **Install** option.
- Press the 确定(OK) or ► to select this option.
- Result: The **Install** menu is displayed.

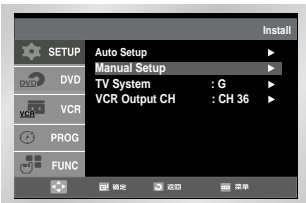

- Press the corresponding ▲, ▼ buttons, until the **Manual Setup** option is selected.
- Press the 确定(OK) or ► to select a **Manual Setup** option.
- Result: The **TV STATION TABLE** menu is displayed.

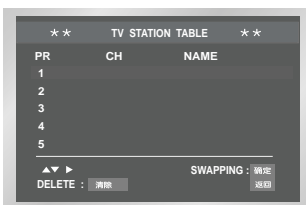

- Press the ▲, ▼ buttons to select a programme number as required.
- Press the ► button to preset the station.
- Result: The **MANUAL TUNING** menu is displayed.

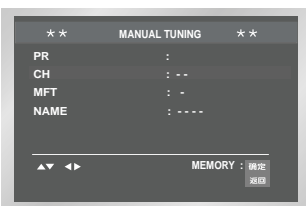

- Press the ◀ or ► buttons to start scanning the channels.
- Result: The frequency band is scanned and the first station found is displayed.

- Press the ▲, ▼ buttons until the **NAME** is selected. The station name is set automatically from the broadcast signal.
- To change the programme's name, press the ► button.
- Result: The first letter of the name flashes.

To...	Then...
Select a character in the name	Press the ▲, ▼ button until the required character is displayed (letters, numbers or “ ” character).
Move to the next or previous character	Press the ◀ or ► buttons respectively.

If you...	Then...
Wish to store the station displayed	<ul style="list-style-type: none"> Press the ▲, ▼ buttons until the MFT is selected. Press the ◀, ► buttons to adjust the picture, if necessary. Press 确定(OK) to store the station
Do not wish to store the station displayed	<ul style="list-style-type: none"> Press the ▲, ▼ buttons until the CH is selected. Press the ◀, ► buttons to go on scanning the frequency band and display the next station Go back to the beginning of Step 14

- Repeat this procedure from Step 6 onwards, until all the required stations have been stored.
- On completion, press the 返回(RETURN) button three times to exit the 菜单(MENU).

Clearing a Preset Station

☞ *If you have stored a TV station:*

- ◆ That you do not require
- ◆ At the wrong programme position you can cancel it.

- 1 After pressing the 菜单(MENU), press the 确定(OK) or ▶.
- Result: The Setup menu is displayed.
- 2 Press the corresponding ▲, ▼ buttons to select the **Install** option.
- 3 Press the 确定(OK) or ▶ to select this option.
Result: The **Install** menu is displayed.

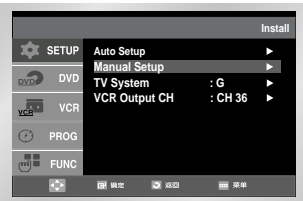

- 4 Press the corresponding ▲, ▼ buttons, until the **Manual Setup** option is selected.
- 5 Press the 确定(OK) or ▶ to select a **Manual Setup** option.
Result: The **TV STATION TABLE** menu is displayed.

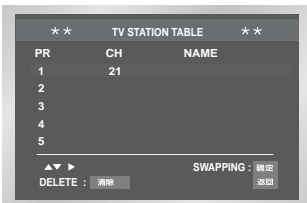

- 6 Press the corresponding ▲, ▼ buttons, until the required preset TV station (PR) is selected.
- 7 Press the 清除(CLEAR) button.
- 8 Repeat the same procedure from Step 6 onwards until all the required stations have been cleared.
- 9 On completion, press the 返回(RETURN) button four times to exit the menu.

Changing the Preset Station Table

You can rearrange the Station Table and give different programme numbers to the stations listed according to your own preferences.

- 1 After pressing the 菜单(MENU), press the 确定(OK) or ▶.
- Result: The Setup menu is displayed.
- 2 Press the corresponding ▲, ▼ buttons to select the **Install** option.
- 3 Press the 确定(OK) or ▶ buttons to select this option.
Result: The **Install** menu is displayed.

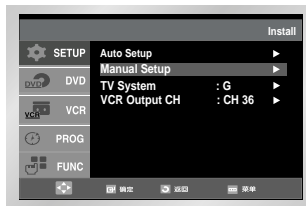

- 4 Press the corresponding ▲, ▼ buttons, until the **Manual Setup** option is selected.
- 5 Press the 确定(OK) or ▶ button to select this option.
Result: The **TV STATION TABLE** menu is displayed.

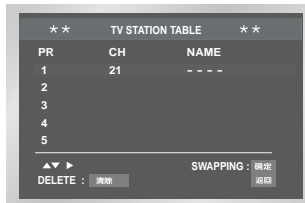

- 6 Press the corresponding ▲, ▼ buttons, until the required preset TV programme is selected.
Result: The selected station is displayed at the same time on the television screen.

Changing the Preset Station Table

- To change the programme number assigned to a station press the 确定(OK) button on the remote control. (For example, To move a TV station in programme 1 to programme 3)
- Press the ▲, ▼ buttons to select required position. And then press 确定(OK) again to swap the position.
- On completion, press the 返回(RETURN) button four times to exit the menu.

Selecting the RF OUT Sound Mode (G-I-K)

You can choose the sound mode (G, I or K) according to the TV set connected to your VCR.

- After pressing the 菜单(MENU), press the 确定(OK) or ► button.
Result: The Setup menu is displayed.
- Press the corresponding ▲, ▼ buttons to select the **Install** option.
- Press the 确定(OK) button to select this option.
Result: The **Install** menu is displayed.
- Press the 确定(OK) ▲ or ▼ buttons, until the **TV System** option is selected.

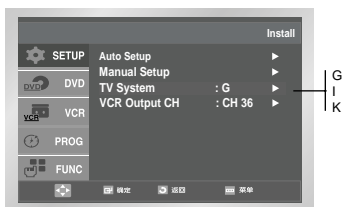

- Press the 确定(OK) or ► button to select G, I or K.
- On completion, press 返回(RETURN) to exit the menu.

Setting the DVD-VCR Output Channel

Your DVD-VCR output channel may need to be changed if the pictures suffer from interference or if your TV cannot find the pictures. Also, you can change the DVD-VCR output channel to adjust the frequency in which information is displayed on the screen.

- After pressing the 菜单(MENU), press the 确定(OK) or ► button.
Result: The Setup menu is displayed.
- Press the corresponding ▲, ▼ buttons to select the **Install** option.
- Press the 确定(OK) or ► to select this option.
Result: The **Install** menu is displayed.

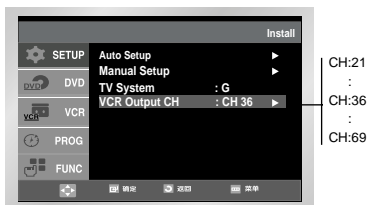

- Press the ▲, ▼ buttons, until the **VCR Output CH** option is selected.
 - Select the required output channel (CH21~CH69) by pressing the 确定(OK) or ► buttons. and ◀ buttons.
- CH21 ◀ ◀ .. CH36 ◀ ◀ .. CH69 ◀ ◀
- On completion, press 返回(RETURN) to exit the menu. Then tune your television again (see page 9).

Selecting the Colour Mode

Before recording or playing back a cassette, you can select the required system standard.

- When you playback an NTSC-recorded tape on this DVD-VCR make a setting on the colour system according to your TV. If your TV is a PAL system only TV, set NTPB. If your TV is Multi System TV (NTSC 4.43 compatible), set NT4.43 and you can record NT4.43.

- 1 After pressing the 菜单(MENU), press the 确定(OK) or ▶.
- Result: The Setup menu is displayed.
- 2 Press the corresponding ▲, ▼ buttons to select the **User Set** option.
- 3 Press the 确定(OK) or ▶ to select this option.
- Result: The **User Set** menu is displayed.

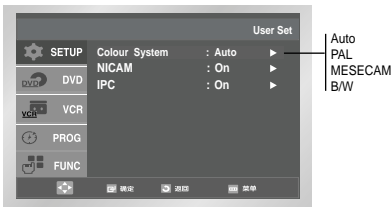

- 4 Press the corresponding ▲, ▼ buttons, until the **Colour System** option is selected.
- 5 Press the 确定(OK) or ▶ button to select **Auto** → **PAL** → **MESECAM** → **B/W**.

B/W	Black and White
-----	-----------------

- 6 On completion, press 返回(RETURN) three time to exit the menu.

NICAM

NICAM programmes are divided into 3 types. NICAM Stereo, NICAM Mono and Bilingual (transmission in another language). NICAM programmes are always accompanied by a standard mono sound broadcast and you can select the desired sound. Please refer to page 20.

- 1 After pressing the 菜单(MENU), press the 确定(OK) or ▶.
- Result: The Setup menu is displayed.
- 2 Press the corresponding ▲, ▼ buttons to select the **User Set** option.
- 3 Press the 确定(OK) or ▶ to select this option.
- Result: The **User Set** menu is displayed.

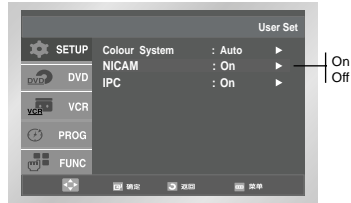

- 4 Press the corresponding ▲, ▼ buttons, until the **NICAM** option is selected.

5 To... Press 确定(OK) or ▶, until...

Mono mode	Off is displayed. Off: Only set at this position to record the standard mono sound during a NICAM broadcast if the stereo sound is distorted due to inferior reception conditions.
-----------	--

NICAM mode	On is displayed. On: Normally set at this position.
------------	---

- 6 On completion, press 返回(RETURN) three times to exit the menu.

Intelligent Picture Control

The Intelligent Picture Control Feature allows you to adjust the sharpness of the image automatically, according to your own preferences.

- 1 During playback, press the 菜单(MENU) button on the remote control.
- 2 Press the 确定(OK) or ►.
Result: The Setup menu is displayed.
- 3 Press the corresponding ▲, ▼ buttons to select the **User Set** option.
- 4 Press the 确定(OK) or ► buttons to select this option.
Result: The **User Set** menu is displayed.

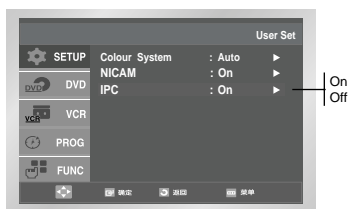

- 5 Press the corresponding ▲, ▼ buttons, until the **IPC** option is selected.
- 6 Press the 确定(OK) or ► buttons to select the IPC (intelligent picture control) option.
➤ When intelligent picture control mode is **ON**, the sharpness of the image is adjusted automatically.
- 7 To adjust the sharpness manually, press the ▼ button to turn the IPC mode **OFF**.
- 8 Press the ◀ or ▶ buttons until the picture is displayed according to your preferences.
➤ If you do not press a button within ten seconds, the **PICTURE** menu disappears automatically.
- 9 On completion, press the 返回(RETURN) button.
➤ You also can directly select this function using IPC button on the remote control.

Auto Power off

The Auto Power Off feature automatically turns off your DVD-VCR if no signal is received and you do not press any button for the selected time.

- 1 After pressing the 菜单(MENU), press the 确定(OK) or ►.
Result: The Setup menu is displayed.

- 2 Press the corresponding ▲, ▼ buttons, until the **Auto Power Off** option is selected.

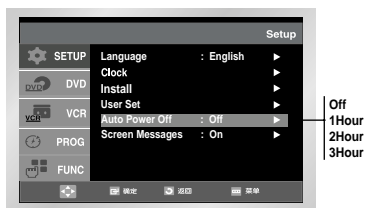

- 3 Press the 确定(OK) or ► buttons, until you select the time of Auto Power Off interval.
→ Off → 1Hour → 2Hour → 3Hour
- 4 On completion, press 返回(RETURN) twice to exit the menu.

Screen Messages

Your DVD-VCR displays most information both on the DVD-VCR and the television.

You can choose to display or hide this information on the television screen (except for the SEARCH, Programming MENU and Timer functions, which cannot be hidden).

- 1 After pressing the 菜单(MENU), press the 确定(OK) or ►.
- 2 Press the corresponding ▲, ▼ buttons, until the **Screen Messages** option is selected.

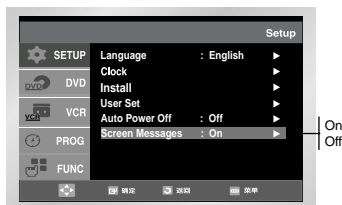

- 3 To... Press 确定(OK) or ►, until...

Display on-screen information **On** is displayed.

Hide on-screen information **Off** is displayed.

- 4 On completion, press 返回(RETURN) twice to exit the menu.

Selecting the Cassette Type

If you wish to use the tape counter to display the time remaining on a cassette, you must indicate the type of cassette inserted.

- 1 After pressing the 菜单(MENU) press the corresponding ▲, ▼ buttons to select the **VCR** option.
- 2 Press the 确定(OK) or ► buttons to select this option.
Result: The **VCR Setup** menu is displayed.
- 3 Press the corresponding ▲, ▼ buttons, until the **Tape Select** option is selected.



- 4 Press the 确定(OK) or ► buttons as many times as required, until the correct cassette length is displayed.

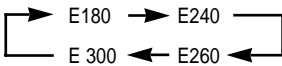

- 5 Press 返回(RETURN) twice to exit the menu.

Repeat Play

You can set repeat play to repeat the tape continuously from beginning to end.



To... Press 确定(OK) or ►, until...

- | | |
|----------------------------|-------------------|
| Repeat play | On is displayed. |
| Do not wish to repeat play | Off is displayed. |

Selecting the Recording Speed

You can record a cassette at two different speeds:

- ◆ SP (Standard Play)
- ◆ LP (Long Play)

In Long Play modes:

- ◆ Each cassette lasts twice as long
- ◆ The recording is of a slightly lower quality

To record a cassette... Press the 速度(SPEED) button on the remote control, until...

- | | |
|-----------------------|------------------|
| In standard play mode | SP is displayed. |
| In long play mode | LP is displayed. |

Type	Recording Time (in SP)
E-180	180 mins. or 3 hours
E-240	240 mins. or 4 hours
E-260	260 mins. or 4 hours and 20 mins.
E-300	300 mins. or 5 hours

S-VHS Play

The DVD-VCR allows you to playback high quality S-VHS tapes.



To... Press 确定(OK) or ►, until...

- | | |
|---------------------------|-------------------|
| S-VHS play | On is displayed. |
| Do not wish to S-VHS play | Off is displayed. |

Recording a Programme Immediately

Before recording a programme, you must have preset the corresponding station (unless you are recording via an external video source). If you have not done so, refer to pages 10 and 11.

- 1 Switch on the television.
 - 2 To monitor the programme being recorded, select the television channel reserved for use with your DVD-VCR (or the AV input if used).
 - 3 Insert the cassette on which the programme is to be recorded, with the window visible and the safety tab intact or the opening covered with adhesive tape.
Result: The DVD-VCR is switched on automatically.
 - 4 Select:
 - ◆ The station to be recorded using the 节目(PROG) (∧ or ∨) buttons
or
 - ◆ The LINE1 source using the 输入选择(INPUT SEL.) button for a satellite tuner or external video sourceResult: The station number is displayed and the programme can be seen on the television.
 - 5 Select the recording speed by pressing the 速度(SPEED) button as many times as required (see page 17).
 - 6 Hold 录像(REC) (●) down for a while to start recording.
Result: The record indicator appears on the television and DVD-VCR display. An index is recorded on the tape (see page 22).
 - 7 To stop recording, press ■ once.
- ◆ If your DVD-VCR ejects the cassette when you start recording, check to make sure that the cassette's safety tab is intact or that the opening (created by a broken safety tab) is covered with adhesive tape.
- ◆ If you reach the end of the tape while recording, the cassette rewinds automatically.

Protecting a Recorded Cassette

Video cassettes have a safety tab to prevent accidental erasure. When this tab has been removed, you cannot record on the tape.

- 1 If you wish to protect a cassette, break off the tab using a small screwdriver.
- 2 To re-record over a protected cassette (safety tab broken), cover the hole with adhesive tape.

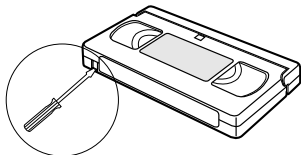

Recording a Programme with Automatic Stop

This function enables you to record up to nine hours (LP) of programmes.

Your DVD-VCR stops automatically after the requested length of time.

- 1 Switch on the television.
 - 2 To monitor the programme being recorded, select the television channel reserved for use with your DVD-VCR (or the AV input if used).
 - 3 Insert the cassette on which the programme is to be recorded, with the window visible and the safety tab intact or the opening covered with adhesive tape.
Result: The DVD-VCR is switched on automatically.
 - 4 Select:
 - ◆ The station to be recorded using the 节目(PROG) (∧ or ∨) buttons
or
 - ◆ The LINE1 source using the 输入选择(INPUT SEL.) button for a satellite tuner or external video sourceResult: The channel number is displayed and the programme can be seen on the television.
 - 5 Select the recording speed by pressing the 速度(SPEED) button as many times as required. (see page 17)
 - 6 Hold the 录像(REC) button (●) down for a while to start recording.
Result: The record indicator appears on the television screen and DVD-VCR display. An index is recorded on the tape. (see page 22)
 - 7 Press the 录像(REC) button (●) several times to increase the recording time in:
 - ◆ 30-minute intervals up to four hours
 - ◆ 1-hour intervals up to nine hoursResult: The length is displayed on the television displays. The selected programme is recorded for the length of time requested. At the end of that time, the DVD-VCR stops recording automatically and power off.
 - 8 If you wish to cancel the recording before the end, press 待机(STANDBY/ON).
- If the end of the tape is reached while recording:
 - ◆ The recording stops and power off.

LENGTH 2:30

SET LENGTH :
PRESS 录像 ●

Using the Timer Programming Feature

The **Timer Programming** feature allows you to preset the DVD-VCR to record a programme up to one month before that programme is to be broadcast. Up to six programmes can be preset.

☛ **Before presetting a recording, check that the date and time are correct.**

- 1 Insert the cassette and press **定时录像(TIMER)** on the remote control.
Result: The Timer Method is displayed.
- 2 Press the **确定(OK)** or **▶** button to select Standard.
Result: The Timer Programming is displayed.

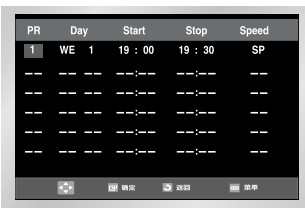

- 3 Select the required station by pressing the **▲**, **▼** buttons or **输入选择(INPUT SEL.)** to select the LINE1 input sources.
- 4 Press **▶** to select the recording day.
- 5 Select the required day by pressing the **▲**, **▼** buttons.
- 6 Press **▶** to select the recording start time.
- 7 Select the required hour value by pressing the **▲**, **▼** buttons.
- 8 Press **▶** to select the minutes.
- 9 Select the required minute value by pressing the **▲**, **▼** buttons.
- 10 Press **▶** to select the recording stop time.
- 11 Select the required recording stop time by pressing the **▲**, **▼** buttons, following the same procedure as when selecting the recording start time.
- 12 Press **▶** to select the recording speed.
- 13 Press the **▲**, **▼** buttons to select the **SP** (Standard Play), **LP** (Long Play), **Auto** (Auto Tape speed Select) recording speeds.
- 14 When you have finished, press the **返回(RETURN)** button.
- 15 Press the **待机(STANDBY/ON)** button to activate the timer.
Result: Before starting recording, the DVD-VCR compares the timer duration with the remaining time on the cassette.

➤ **Auto Tape Speed select.** The DVD-VCR's "Auto Tape Speed select" function compares the duration of the timer recording to the actual recording time remaining on the tape loaded. If there is insufficient tape to complete a timer recording in **AUTO** mode, the DVD-VCR automatically switches to **LP** mode to record the whole programme.

Checking a Preset Recording

You can check your preset recordings:

- ◆ **When you have finished presetting the DVD-VCR**
- ◆ **If you have forgotten which programmes will be recorded**

- 1 Insert the cassette and press **定时录像(TIMER)** on the remote control.
Result: The Timer Method is displayed.
- 2 Press the **确定(OK)** or **▶** button to select Standard.
Result: The Timer Programming is displayed.
- 3 Press the **◀** or **▶** button to select and change any values as required. For more details, refer to the previous page.
- 4 On completion, press **返回(RETURN)** twice.

Cancelling a Preset Recording

You can cancel any programmes that are:

- ◆ **Incorrect**
- ◆ **No longer required**

- 1 Insert the cassette and press 定时录像(TIMER) on the remote control.
Result: The Timer Method is displayed.
- 2 Press the 确定(OK) or ► button to select Standard.
Result: The Timer Programming is displayed.
- 3 Press the 清除(CLEAR) button to cancel the selected programme.
Result: All the recording information is deleted and the broadcast will not be recorded.
- 4 On completion, press 返回(RETURN) twice.

Playing a Cassette

This function allows you to play back any pre-recorded cassette.

- 1 Switch on both the television and your DVD-VCR.
- 2 Insert the video cassette to be played. If the safety tab on the cassette is intact, press ►II.
Otherwise, the cassette is played automatically.
 - When a cassette is loaded, the tape position is optimized automatically to reduce disturbance (Digital Auto Tracking).
When playing a cassette, if the end of the tape is reached, the cassette is rewound automatically.

To...	Then press...
Stop the playback	■ (STOP).
Eject the cassette	▲ (EJECT).

Adjusting Picture Alignment Manually

The Picture Adjustment feature allows you to adjust the alignment manually to obtain the best possible picture.

When noise bars or streaks appear during playback, adjust alignment manually by pressing the 磁迹跟踪 (TRK) buttons until the picture is clear and stable.

- Result:
- ◆ The tracking bar appears.
 - ◆ The image is adjusted.
 - ◆ The tracking bar disappears when you release the button.

Selecting the Audio Output Mode

You can select the mode in which the sound is reproduced on the loudspeakers and AV outputs. The following options are available.

Option	Description
L	Used to listen to the sound on the left Hi-Fi channel.
R	Used to listen to the sound on the right Hi-Fi channel.
MIX	Used to listen to the mixed sound of the Hi-Fi and normal channels.
MONO	Used to listen to the sound on the normal mono channel.
L R	Used to listen to Hi-Fi stereo sound on the left and right channels. <ul style="list-style-type: none">➤ When playing back tapes recorded in Hi-Fi, the sound switches to Hi-Fi after five seconds of Mono.

To select the sound mode, simply press the 声音 (AUDIO) button on the remote control until the required option is displayed.

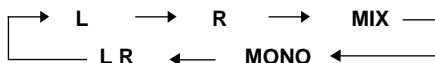

Playing a Cassette in Slow Motion

You can play a cassette in slow motion.

- No sound is heard when playing back a cassette in slow motion.

1 Press:

- ◆ ►|| to start playing the cassette
- ◆ ►|| button one more time to make still mode.
- ◆ ►► to start SLOW mode.
- ◆ ◀◀ or ►► button as many times as required to decrease or increase the speed respectively
- ◆ To 返回(return) to the normal speed, press the ►|| button twice.

2 When playing back in slow motion, picture interference may occur.

Press the 磁迹跟踪(TRK) buttons to minimize this effect.

- When you have been using the Slow Motion function for more than about two minutes, the DVD-VCR will automatically play to protect the:
 - ◆ Cassette
 - ◆ Video heads

Playing a Sequence at Variable Speeds

You can vary the playback speed using the Shuttle function (up to nine times the normal speed).

Example: You wish to analyse a sportsperson's technique, movement by movement.

The Shuttle function is available on the Remote control

- No sound is heard when playing a sequence at variable speeds.

1 Press:

- ◆ ►|| during playback
- ◆ 穿梭(SHUTTLE) (<<) to play the cassette backwards
- ◆ 穿梭(SHUTTLE) (>>) to play the cassette forwards

2 Each time you press a 穿梭(SHUTTLE) button, the speed is changed as shown in the following illustration.

REVERSE PLAY X9	REVERSE PLAY X5	REVERSE PLAY X3	STILL	SLOW MOTION X1/10	SLOW MOTION X1/5	PLAY X3	PLAY X5	PLAY X9
-----------------------	-----------------------	-----------------------	-------	-------------------------	------------------------	------------	------------	------------

Playing a Sequence Frame by Frame

You can

- ◆ Stop the cassette at a given frame (image)
- ◆ Advance one frame at a time

- No sound is heard when playing back frame by frame.

1 Press:

- ◆ ►|| to start playing the cassette
- ◆ ►|| button one more time to make still mode.
- ◆ 帧进(F.ADV/STEP) to advance frame by frame

2 To 返回(RETURN) to normal playback, press ►||.

- Vertical stability: When playing back frame by frame, interference may be seen on the screen. Press the 磁迹跟踪(TRK) buttons to minimize this effect.

Searching for a Specific Sequence

Each time you record a cassette on this DVD-VCR, an "index" is automatically marked on the tape when recording starts.

The Search function allows you to fast-forward or rewind to a specific index and start playback from that point. Depending on the direction selected, the indexes are numbered as follows:

↓

etc.	Prev Seq.	Seq. being played	Next Seq.	etc.
	2	1	1	2

- This DVD-VCR uses a standard indexing system (VISS). As a result, it will recognize any indexes marked by other VCRs using the same system and vice versa.

Go To [0:00:00] Stop

Use this feature when you want to search for the 0:00:00 counter position on a cassette. Press the CLEAR button at the point on the tape where you want to set the counter to 0:00:00.

The VCR will rewind or fast forward, searching for the 0:00:00 counter position, and then automatically stop at that position.

- 1 After pressing the SEARCH, press the corresponding ▲, ▼ buttons, until the Go To [0:00:00] option is selected.

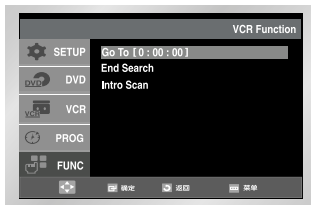

- 2 Press the 确定(OK) or ►.

End Search

Use this feature when you want to search for a blank position to record a program on a cassette. The VCR will fast forward, searching for a blank position, and then automatically stop at that position. If the VCR reaches the end of the tape during end search, the tape will be ejected.

- 1 After pressing the SEARCH, press the corresponding ▲ or ▼ buttons, until the End Search option is selected.
- 2 Press the 确定(OK) or ►.

Intro Scan

- 1 After pressing the SEARCH, press the corresponding ▲, ▼ buttons, until the Intro Scan option is selected.
- 2 Press the 确定(OK) or ►.
- 3 Press the ◀ or ▶ buttons depending on the direction where your desired programme is located.
- 4 When an Index mark is found the DVD-VCR will playback the tape for 5 seconds, after which it will continue searching for the next Index mark.
- 5 If you want to watch the tape from a particular Index, simply press ►|| twice.

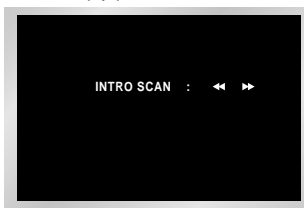

Index Skip Search

This feature will enable you to fast forward/rewind to a specific point on a tape: E.g. if you have recorded 3 different programmes on a tape and you have rewound the tape to the beginning, by using this feature you can go directly to the start of programme 2 simply by pressing the SEARCH button.

- 1 After pressing the SEARCH, press the corresponding ▲, ▼ buttons, until the Intro Scan option is selected.
- 2 Press the 确定(OK) or ►.
- 3 Press the ◀ or ▶ buttons twice more. This will take you directly to the start of the desired programme is located.
- 4 These Index searches can be made forwards: (press ▶▶) or backwards: (press ◀◀). (◀◀-20 . . 0 . . +20 ▶▶)
- 5 To cancel an Index search simply press the ►|| or ■ button.



Using the Tape Counter

The tape counter:

- ◆ Indicates the elapsed time in the play and record modes (hours, minutes and seconds)
- ◆ Is reset when a cassette is inserted in the DVD-VCR
- ◆ Allows you to find the beginning of a sequence easily

☞ *If the remaining time is to be calculated correctly, you must indicate the type of cassette being used.*

- 1 Insert a cassette in your DVD-VCR.
- 2 To set the tape counter to zero at the beginning of a sequence:
 - ◆ Press 显示(INFO.) twice to display the counter
 - ◆ Press 清除(CLEAR) when you want to set the tape counter to zero.

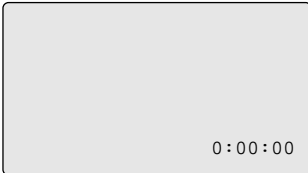

- 3 When you are ready,
 - ◆ Start playback or Recording.
 - ◆ Press the ■ button.
 - ◆ To fast-forward or rewind to the sequence at which the counter was set to zero, press ◀◀ or ▶▶.

➤ Some DVD-VCR information, such as the counter, can be displayed on the television screen (unless you have deactivated the Screen messages mode; refer to page 16).

Press 显示(INFO.):

- ◆ Once to display the current function, programme number, recording speed, date, time and counter
- ◆ Twice to display the counter only
- ◆ Three times to display the time remaining on the cassette
- ◆ Four times to clear the display

Using the Assemble Edit Function

This function allows you to start a new recording at a specific position on the cassette while maintaining a very smooth scene change.

- 1 Insert the cassette to be edited in your DVD-VCR.
- 2 Press the ►|| button to start playback.
- 3 When you reach the position from which you wish to start the new recording, press the ►|| button.
- 4 Press the 帧进(F.ADV/STEP) button again as often as necessary to advance frame by frame, until the exact recording position is located.
- 5 While the DVD-VCR is in still mode, hold the 录像(REC) button (●) down for a while to activate the Assemble Edit function.
- 6 Select the source from which you wish to record by pressing:
 - ◆ The 节目(PROG) buttons for television channels
 - ◆ The 输入选择(INPUT SEL.) button for the LINE input sources
- 7 Press the ►|| button to start recording.
- 8 When you have finished recording, press ■.

Recording from Another VCR or Camcorder

You can copy a cassette to your DVD-VCR from another video source, such as another VCR or a camcorder.

➤ *It is an infringement of copyright laws to copy prerecorded cassettes or to re-record them in any form without the permission of the owners of the corresponding copyright.*

- 1 Connect the DVD-VCR, from which the cassette is to be copied, to the appropriate A/V input connectors on the rear of your DVD-VCR, as indicated on page 7.
- 2 Insert a blank cassette in your DVD-VCR.
- 3 Insert the pre-recorded cassette in the other video source (VCR or camcorder).
- 4 Press the 输入选择 (INPUT SEL.) button to select the appropriate input on your DVD-VCR: LINE IN for the AV input.
- 5 Start playing back the cassette to be copied.
- 6 Hold 录像 (REC) (●) down for a while to start recording on your DVD-VCR.
- 7 When you have finished recording, press ■ on both VCR and DVD-VCR.

➤ If you wish to view the cassette being copied:

- ◆ Your DVD-VCR must be connected as usual to the television (see page 6-7 for further details)

Using the KARAOKE Function

- 1 Press the 待机 (STANDBY/ON) button and insert KARAOKE tape.
- 2 Connect Mic into MIC1 or MIC2 jack. Then the KARAOKE mode is transferred "ON" mode.
 - ◆ Disconnect the Mic makes the KARAOKE mode transfer to "OFF" mode automatically.
 - ◆ Press the 卡拉OK (KARAOKE) button on the remote control. Press the ◀ or ▶ button to select KARAOKE mode "ON".
- 3 Adjust the Mic volume and ECHO level.
- 4 Sing with accompaniment.

SCORE Function

- 1 Press the 卡拉OK (KARAOKE) button on the remote control.
- 2 Press the corresponding ▲ or ▼ buttons to select the SCORE mode.
- 3 Press the ◀ or ▶ buttons to select the SCORE mode "ON".
- 4 Score will pop up whenever a song is completed.

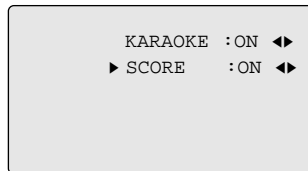

KARAOKE SEARCH Function

- 1 Press the 待机 (STANDBY/ON) button and insert KARAOKE tape.
- 2 Press the 卡拉OK (KARAOKE) button on the remote control. Press the ◀ or ▶ button to select KARAOKE mode "ON".
- 3 Press ▶|| to start playing the cassette.
- 4 When you want the next song during playing a song, press the 卡拉OK搜索 (KARAOKE SEARCH) ▶▶ or 卡拉OK搜索 (KARAOKE SEARCH) ◀◀ buttons on the remote control.

Choosing a Connection

The following show examples of connections commonly used to connect the DVD -VCR player with a TV and other components. It is only available for DVD. The VCR out can not watch by this connection.

Connection to an Audio System

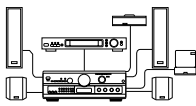

Dolby Digital Decoder Digital Audio Input Jack

Connection to a Television

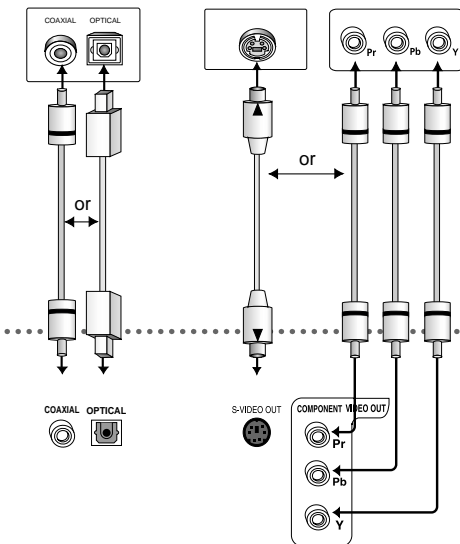

Digital Audio out Jack

S-Video Jack

Component Video Jack

Setting Up the Language Features

If you set the player menu's disc menu, audio and subtitle language in advance, they will come up automatically every time you watch a movie.

Using the Disc Menu Language

This function changes the text language only on the disc menu screens.

- 1 With the unit in Stop mode, press the 菜单(MENU) button.
- 2 Select DVD using ▲, ▼ buttons, then 确定(OK) or ► button



- 3 Select **Language Setup** using ▲, ▼ buttons, then press the 确定(OK) or ► button.

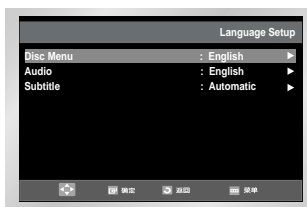

- 4 Select **Disc Menu** using ▲, ▼ buttons, then press the 确定(OK) or ► button.
- 5 Use the ▲, ▼ buttons to select 'English'.
- Select "Others" if the language you want is not listed.



- 6 Press the 确定(OK) button.
- English is selected and the screen returns to **Language Setup** menu.

Setting up the Language Features

Using the Audio Language

- 1 With the unit in Stop mode, press the 菜单(MENU) button.
- 2 Select **DVD** using ▲,▼ buttons, then 确定(OK) or ► button.
- 3 Select **Language Setup** using ▲,▼ buttons, then press the 确定(OK) or ► button.



- 4 Select **Audio** using ▲,▼ buttons, then press the 确定(OK) or ► button.
- 5 Press the ▲,▼ buttons to select **English**.
 - Select "Original" if you want the default soundtrack language to be the original language the disc is recorded in.
 - Select "Others" if the language you want is not listed.

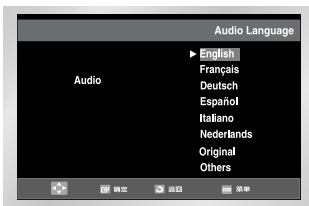

- 6 Press the 确定(OK) button.
 - English is selected and the screen returns to **Language Setup** menu.

Using the Subtitle Language

- 1 With the unit in Stop mode, press the 菜单(MENU) button.
- 2 Select **DVD** using ▲,▼ buttons, then 确定(OK) or ► button.
- 3 Select **Language Setup** using ▲,▼ buttons, then press the 确定(OK) or ► button.



- 4 Select **Subtitle** using ▲,▼ buttons, then press the 确定(OK) or ► button.
- 5 Use the ▲,▼ buttons to select **English**.
 - Select "Automatic" if you want the subtitle language to be the same as the language selected as the audio preference.



- Select "Others" if the language you want is not listed. Some discs may not contain the language you select as your initial language; in that case the disc will use its original language setting.
- 6 Press the 确定(OK) button.
 - English is selected and the screen returns to **Language Setup** menu.

Setting Up the Audio Options

- 1 With the unit in Stop mode, press the 菜单(MENU) button.
- 2 Select DVD using ▲, ▼ buttons, then 确定(OK) or ► button.

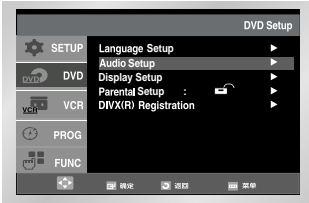

- 3 Select **Audio Setup** using ▲, ▼ buttons, then press the 确定(OK) or ► button.
- 4 Use the ▲, ▼ buttons to select the desired item. Then press the 确定(OK) or ► button.

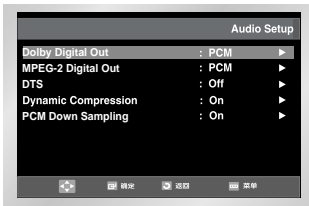

■ Dolby Digital Out

1. PCM : Converts to PCM(2CH) audio. Select PCM when using the Analog Audio Outputs.
 2. Bitstream : Converts to Dolby Digital Bitstream (5.1CH). Select Bitstream when using the Digital Audio Output.
- Be sure to select the correct Digital Output or no audio will be heard.

■ MPEG-2 Digital Out

1. PCM : Converts to PCM(2CH) audio. Select PCM when using the Analog Audio Outputs.
2. Bitstream : Converts to MPEG-2 Digital Bitstream (5.1CH or 7.1CH). Select Bitstream when using the Digital Audio Output.

■ DTS

1. Off : Doesn't output digital signal.
2. On : Outputs DTS Bitstream via digital output only. Select DTS when connecting to a DTS Decoder.

■ Dynamic Compression

1. On : To select dynamic compression.
2. Off : To select the standard range.

■ PCM Down Sampling

1. On : Select this when the amplifier connected to the player is not 96KHz compatible. In this case, the 96 Hz signals will be down converted to 48KHZ.
2. Off : Select this when the amplifier connected to the player is 96KHz compatible. In this case, all signals will be output without any changes.

- • How to make the SETUP menu disappear or return to menu screen during set up; Press 返回(RETURN) or ◀ button.
- Manufactured under license from Dolby Laboratories. "Dolby" and the double-D symbol are trademarks of Dolby Laboratories.
 - "DTS" and "DTS Digital Out" are trademarks of Digital Theater Systems, Inc.

Setting Up the Display Options

- 1 With the unit in Stop mode, press the 菜单(MENU) button.
- 2 Select DVD using ▲, ▼ buttons, then 确定(OK) or ► button.



- 3 Select **Display Setup** using ▲, ▼ buttons, then press the 确定(OK) or ► button.
- 4 Use the ▲, ▼ buttons to select the desired item. Then press the 确定(OK) or ► button.

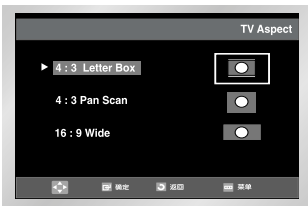
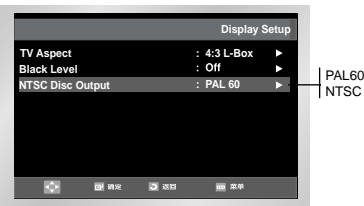

■ TV Aspect

Depending on the type of television you have, you may want to adjust the screen setting (aspect ratio).

1. 4:3 Letter Box : Select when you want to see the total 16:9 ratio screen DVD supplies, even though you have a TV with a 4:3 ratio screen. Black bars will appear at the top and bottom of the screen.
2. 4:3 Pan Scan : Select this for conventional size TVs when you want to see the central portion of the 16:9 screen. (Extreme left and right side of movie picture will be cut off.)
3. 16:9 Wide : You can view the full 16:9 picture on your widescreen TV.

■ Black Level

Adjusts the brightness of the screen.(On/Off)

■ NTSC Disc Output

“NTSC” if the screen only has one NTSC-video entrance. If this is not the case, you can choose to leave “PAL60” as is.

Setting Up the Parental Control

The Parental Control function works in conjunction with DVDs that have been assigned a rating - which helps you control the types of DVDs that your family watches.

There are up to 8 rating levels on a disc.

- 1 With the unit in Stop mode, press the 菜单(MENU) button.
- 2 Select DVD using ▲, ▼ buttons, then 确定(OK) or ► button.
- 3 Select **Parental Setup** using ▲, ▼ buttons, then press the 确定(OK) or ► button.



- 4 Use 确定(OK) or ► to select **Yes** if you want to use a password. The **Enter Password** screen appears.

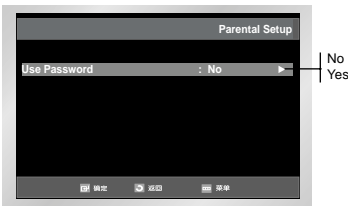

- 5 Enter your password. The **Re-Enter Password** screen appears to confirm the password. Enter your password again. The Parental Setup screen appears.



■ About the Rating Level ;

The Rating Level will work only when **Use Password** is set to Yes. To unlock the player, use ► or 确定(OK) to select No. Use ▲, ▼ to select **Rating Level**. Press OK.

- Use ▲, ▼ to select the level(e.g. Level 6) and press 确定(OK). Discs that contain Level 7 will now not play.
- To cancel the rating level, use ► or 确定(OK) to select No in Use Password.

■ About the Change Password ;

- Use ▲, ▼ to select Change Password. Press 确定(OK). The Change Password screen appears.
- Enter your new password. Re-Enter the new password again.

- How to make the SETUP menu disappear or return to menu screen during set up; Press 返回(RETURN) or ◀ button.
- If you have forgotten your password, see Forget Password in the Troubleshooting Guide.

During DVD/CD playback you can select from the following special playback options. To resume normal playback, press the ►II button.

1 Still

Press the ►II button on the remote control during playback.

- The picture will still and the audio will mute.
- To resume playback, press the ►II button.
- If the player is left in Still mode for 5 minutes, it will stop automatically.

2 Frame Advance (Step)

While in playback mode, press the 帧进(F.ADV/STEP) button on the remote control to advance one frame at a time.

- Audio is muted during Frame Advance mode.
- Press ►II to resume normal playback.

NOTE: Frame Advance operates only in the forward direction.

3 Skip Forward/Back

While a CD or DVD disc is in Play mode, press the Skip I◀◀ / ▶▶I buttons on the remote control or front panel to jump forward and backward through disc chapters/tracks.

- Skip Forward will jump to the next chapter/track.
- Skip Back will jump to the beginning of the current chapter/track.
- Press Skip Back again to jump to the beginning of the previous chapter/track.

Search Forward/Back

While a disc is in Play mode, press and hold the ◀◀ / ▶▶ buttons on the remote control or front panel to visually search forward/backward at 2X - 4X - 8X - 16X - 32X - 128X speed. Press ►II button to resume normal speed.

4 Slow Motion

During playback, press the ►II button to Still the image. Then use the Search ▶▶ to play in slow motion at variable speeds.

- Each press increases the slow motion speed playback to 1/8, 1/4 or 1/2 normal speed.
- Audio is muted during slow motion playback.

5 Stop/Resume

- Press the Stop button once to stop playback. To resume the DVD/CD from the point where the disc stopped, press the ►II button.
- Press the ■ button twice to completely stop playback. The next time you press ►II, the disc will start over from the beginning.

To take full advantage of the movie theater experience that DVD offers, you may want to connect your DVD-VCR to a complete Surround Sound system, including an A/V Receiver and six Surround Sound speakers.

Before You Begin...

- If your A/V receiver is equipped with a Dolby Digital Decoder, you have the option to bypass the DVD-VCR's built-in Dolby Digital Decoder. Use the Digital Audio Out connection below.

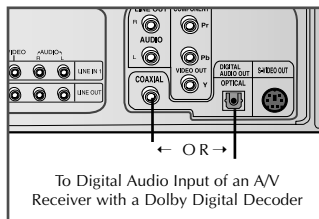

1 Digital Audio Out

Connect EITHER an optical cable OR a digital coaxial cable from the Digital Audio Out jacks on the back panel of the DVD-VCR to their corresponding Digital Audio Input jacks on your A/V Receiver:

- Optical
- Coaxial
- Use whichever connection is available on your A/V Receiver.

Adjusting the Aspect Ratio (EZ View)

To play back using aspect ratio (DVD)

- 1 Press the EZ VIEW button.
 - The screen size changes when the button is pressed repeatedly.
 - The screen zoom mode operates differently depending on the screen setting in the initial DVD menu.
 - To ensure correct operation of the EZ VIEW button, you should set the correct aspect ratio in the initial setup.

If you are using a 16:9 TV

■ For 16:9 aspect ratio discs

- **Wide Screen**
Displays the content of the DVD title in 16:9 aspect ratio.
- **Screen Fit**
The top and bottom of the screen are cut off. When playing a 2.35:1 aspect ratio disc, the black bars at the top and bottom of the screen will disappear. The picture will look vertically stretched. (Depending on the type of disc, the black bars may not disappear completely.)
- **Zoom Fit**
The top, bottom, left and right of the screen are cut off and the central portion of the screen is enlarged.

■ For 4:3 aspect ratio discs

- **Normal Wide**
Displays the content of the DVD title in 16:9 aspect ratio. The picture will look horizontally stretched.
- **Screen Fit**
The top and bottom of the screen are cut off and the full screen appears. The picture will look vertically stretched.
- **Zoom Fit**
The top, bottom, left and right of the screen are cut off and the central portion of the screen is enlarged.

If you are using a 4:3 TV

■ For 16:9 aspect ratio discs

- **4:3 Letter Box**
Displays the content of the DVD title in 16:9 aspect ratio.
The black bars will appear at the top and bottom of the screen.
- **4:3 Pan Scan**
The left and right of the screen are cut off and displays the central portion of the 16:9 screen.
- **Screen Fit**
The top and bottom of the screen are cut off and the full screen appears. The picture will look vertically stretched.
- **Zoom Fit**
When a 4:3 DVD is viewed on a 16:9 TV, black bars will appear at the left and right of the screen in order to prevent the picture from looking horizontally stretched.

■ For 4:3 aspect ratio discs

- **Normal Screen**
Displays the content of the DVD title in 4:3 aspect ratio.
- **Screen Fit**
The top and bottom of the screen are cut off and the full screen appears. The picture would look vertically stretched.
- **Zoom Fit**
The top, bottom, left and right of the screen are cut off and the central portion of the screen is enlarged.

➤ This function may behave differently depending on the type of disc.

Using the Display Function

When Playing a DVD/VCD/CD

- 1 During play, press the 显示(INFO.) button on the remote.
- 2 Use the ▲, ▼ buttons to select the desired item.
- 3 Use the ◀, ▶ buttons to make the desired setup.
 - You may use the number buttons of the remote control to directly access a title, chapter or to start the playback from the desired time.



- 4 To make the screen disappear, press the 显示 (INFO.) button again.

- • **What is a Chapter?**
Each Title on a DVD is usually divided into chapters (similar to tracks on an audio CD).
- **What is a Title?**
A DVD may contain several different titles. For example, if a disc contains four different movies, each might be considered a title.



To access the desired title when there is more than one in the disc. For example, if there is more than one movie on a DVD, each movie will be identified.



Most of DVD discs are recorded in chapters so that you can quickly find a specific passage.



Allows playback of the film from a desired time. You must ok the starting time as a reference.



Refers to the language of the film soundtrack. In the example, the soundtrack is played in English 5.1CH. A DVD disc can have up to eight different soundtracks.



Refers to the subtitle languages available in the disc. You will be able to choose the subtitles language or, if you prefer, turn them off from the screen. A DVD disc can have up to 32 different subtitles.



A surround sound effect is generated using only two front speakers.

* When in VCD 2.0 mode (MENU ON mode), this function does not work.

Use the DISC MENU button in VCD 2.0 mode to select MENU ON or OFF.

Changing the Camera Angle

Using the 角度(ANGLE) button

When a DVD contains multiple angles of a particular scene, you can select the Angle function.

Press the 角度(ANGLE) button to see if an 角度(ANGLE) (ⓐ) mark is present at the upper Right hand corner of the screen.

- 1 When an 角度(ANGLE) mark is shown, press the 角度(ANGLE) button, then an 角度(ANGLE) select icon will appear at the upper left hand corner of the screen.
- 2 Use the ◀, ▶ buttons to select the desired screen angle.
- 3 To turn off the display, press the 角度(ANGLE) button again.



Selecting the Subtitle Language

You can select a desired subtitle quickly and easily with the subtitle button.

Using the 字幕(SUBTITLE) button

- 1 Press the 字幕(SUBTITLE) button.
- 2 Use the ◀, ▶ buttons to select the desired subtitle language.
- 3 Use the ▲, ▼ buttons to determine whether or not the subtitle will be displayed.
 - The subtitle languages are represented by abbreviations.



- This function depends on what languages are encoded on the disc and may not work with all DVDs.
- A DVD disc can contain up to 32 subtitle languages.
- How to have the same subtitle language come up whenever you play a DVD; Refer to “Setting Up the Language Features” on page 26.

Repeat Play

Repeat the current track, chapter, title, a chosen section (A-B), or all of the disc.

When playing a DVD

- 1 Press the 重播(REPEAT) button on the remote. Repeat screen appears.
- 2 Select Chapter, Title or A-B using the ◀, ▶ buttons.
 - Press the 重播(REPEAT) button. Select A-B on screen with the ◀, ▶ buttons.
 - Press 确定(OK) at the point where you want the repeat play to start (A). The B is automatically highlighted.
 - Press 确定(OK) at the point where you want the repeat play to stop (B).
 - To terminate the function, press the 清除(CLEAR) button.
 - A-B REPEAT does not allow you to set point (B) until at least 5 seconds has elapsed after point (A) has been set.

DVD

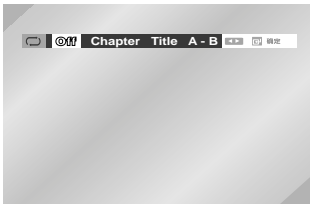

VCD / CD

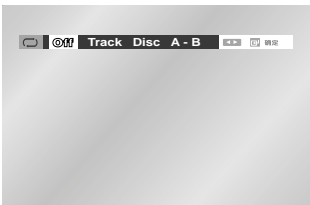

- 3 Press 确定(OK).
 - 4 To return to normal play, press 重播(REPEAT) again, then press the ◀, ▶ buttons to select Off and press 确定(OK).
 - It is available to press 清除(CLEAR) button on the remote controller in order to stop 重播(REPEAT) play.
- DVD repeats play by chapter or title, CD and VCD repeat play by disc or track.
- Depending on the disc, the Repeat function may not work.
 - When in VCD 2.0 mode (MENU ON mode), this function does not work.

Selecting the Audio Language

You can select a desired language quickly and easily with the 声音(AUDIO) button.

Using the 声音(AUDIO) button

- 1 Press the 声音(AUDIO) button.
- 2 Use the ◀, ▶ buttons to select the desired language on a DVD.
 - The audio languages are represented by abbreviations.
- 3 Use the ◀, ▶ buttons to select Stereo, ◀ or ▶ (On VCD/CD)

DVD



VCD / CD

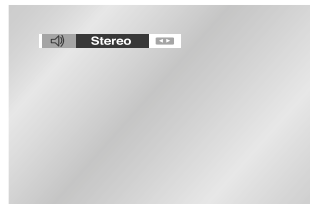

- This function depends on what languages are encoded on the disc and may not work with all DVDs.
- A DVD disc can contain up to 8 audio languages.
 - How to have the same audio language come up whenever you play a DVD ; Refer to "Setting Up the Language Features" on page 26.

Using the Mark Function

This feature lets you mark sections of a DVD or VCD (MENU OFF mode) so you can quickly find them at a later time.

Using the Mark Function (DVD/VCD)

- 1 During play, press the 书签(MARK) button on the remote. The Mark icons will be displayed.



- 2 Use the ◀, ▶ buttons to move to the desired Mark icon.
- 3 When you reach the scene you want to mark, press the 确定(OK) button. The icon will change to a number (1, 2, or 3).
- 4 Press the 书签(MARK) button to turn off the display.

Recalling a Marked Scene

- 1 During play, press the 书签(MARK) button on the remote.
- 2 Use the ◀, ▶ buttons to select a marked scene.
- 3 Press the ▶|| buttons to skip to the marked scene.

Clearing a Mark

- 1 During play, press the 书签(MARK) button on the remote.
 - 2 Use the ◀, ▶ buttons to select the mark number you want to delete.
 - 3 Press the 清除(CLEAR) button to delete a mark number. Press the 书签(MARK) button to turn off the display.
-
- Up to three scenes may be marked at a time.
 - When in VCD 2.0 mode (MENU ON mode), this function does not work.
 - Depending on the disc, the mark function may not work.

MP3/WMA Play

If you insert an MP3/WMA Disc into the DVD-VCR player, you can see the folder directory.

- Select the desired folder in the root directory.
- Use the 确定(OK) or ► button to select the desired folder.

MP3/WMA Play Function

- 1 Press the 确定(OK) or ► button, the selected music file will be played back.
Up to 8 music folders can be displayed at a time. If you have more than 8 folders on a disc, press the ▼ button to display them on the screen.

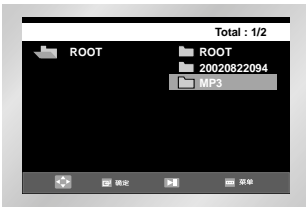

- 2 Use the ▲, ▼ buttons to select the desired music folder, then press 确定(OK). Press the ▲, ▼ buttons again to select a music file. Press the 确定(OK) button to begin playback of a music file.

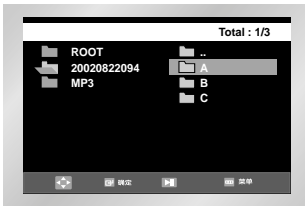

Program/Random playback

- 1 Press the 模式(MODE) button in STOP mode to switch between the RANDOM and PROGRAM modes.



- • Press the 重播(REPEAT) button in PLAY mode to hear only music continuously and press it once again to release.

CD-R MP3/WMA discs

When playing CD-R/MP3 or WMA discs, please follow all the recommendations for CD-R above, plus the comments below:

- Your MP3 or WMA files should be ISO 9660 or JOLIET format.

ISO 9660 format and Joliet MP3 or WMA files are compatible with Microsoft's DOS and Windows, and with Apple's Mac. These two formats are the most widely used.

- When naming your MP3 or WMA files do not exceed 8 characters, and place ".mp3, .wma" as the file extension.

General name format of: Title.mp3. or Title.wma.
When composing your title, make sure that you use 8 characters or less, have no spaces in the name, and avoid the use of special characters including: (.,/, \, =, +).

MP3/WMA Play

■ Use a decompression transfer rate of at least 128Kbps when recording MP3 files.

Sound quality with MP3 files basically depends on the rate of compression/decompression you choose. Getting audio CD quality sound requires an analog/digital sampling rate, that is conversion to MP3 format, of at least 128 Kbps and up to 160 Kbps. However, choosing higher rates, like 192 Kbps or more, only rarely give better sound quality. Conversely, files with decompression rates below 128 Kbps will not be played properly.

■ Use a decompression transfer rate of at least 64Kbps when recording WMA files.

Sound quality with WMA files basically depends on the rate of compression/decompression you choose. Getting audio CD quality sound requires an analog/digital sampling rate, that is conversion to WMA format, of at least 64Kbps and up to 192Kbps. Conversely, files with decompression rates below 64Kbps or over 192Kbps will not be played properly.

■ Do not try recording copyright protected MP3 files.

Certain "secured" files are encrypted and code protected to prevent illegal copying. These files are of the following types: Windows Media™ (registered trade mark of Microsoft Inc) and SDMITM (registered trade mark of The SDMI Foundation). You cannot copy such files.

■ Important :

The above recommendations cannot be taken as a guarantee that the DVD player will play MP3 recordings, or as an assurance of sound quality. You should note that certain technologies and methods for MP3 file recording on CD-Rs prevent optimal playback of these files on your DVD player (degraded sound quality and in some cases, inability of the player to read the files).

■ This unit can play a maximum of 500 files and 300 ... folders per disc.

Program Play & Random Play

Program Play (CD/MP3/WMA)

- 1 Press the 模式(MODE) button.
- 2 Use the ◀, ▶ buttons to select PROGRAM. Press the 确定(OK) button.



- 3 Use the ▲, ▼ / ◀, ▶ buttons to select the first track to add to the program. Press the 确定(OK) button. The selection numbers appear in the Program Order box.

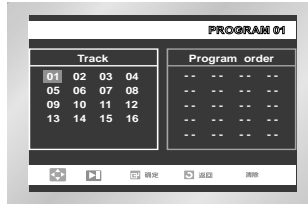

- 4 Press the ▶|| button. The disc will be played in programmed order.

Random Play (CD/MP3/WMA)





- 1 Press the 模式(MODE) button.
- 2 Use the ◀, ▶ buttons to select RANDOM. Press the 确定(OK) button. The disc will be played in random order.



- Depending on the disc, the Program and Random Play functions may not work.
- To resume normal play, press the 清除(CLEAR) button.
- This unit can support a maximum of 20 programmed order.



Picture CD Playback

- 1 Open the disc tray.
- 2 Load the disc on the tray.
Load the disc with the labeled side up.
- 3 Close the tray.
 - The tray closes and you should get a screen that looks like the one below.
 - Use the ▲, ▼ buttons on the remote controller to select the picture you want to view and then press the 确定(OK) button.
 - To see the next 6 pictures, press the ►► button.
 - To see the previous 6 pictures, press the ◀◀ button.

-  : Return to the Album Screen.
-  : Each time the 确定(OK) button is pressed, the picture rotates 90 degrees clockwise.
-  : Each time the 确定(OK) button is pressed, the picture is enlarged up to 4X. (Normal → 2X → 4X → Normal)
-  : The unit enters slide show mode.

* Press the 返回(RETURN) button to return to the album screen.

* Before the Slide Show can begin, the picture interval must be set.

-  : When this icon is selected and 确定(OK) is pressed, the pictures change automatically with about a 6 second interval.
-  : The pictures change automatically with about an 12 second interval.
-  : The pictures change automatically with about an 18 second interval.

* Depending on the file size, each interval between images may take longer or shorter than the manual suggests.

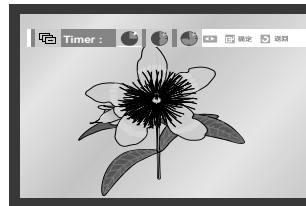
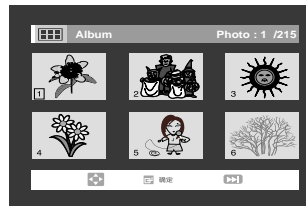
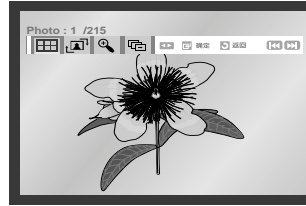
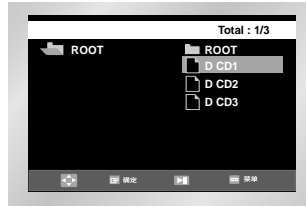

- • If no buttons on the remote control are pressed for 10 seconds, the menu will disappear. Press the 光盘菜单(DISC MENU) button on the remote control to display the menu again.

CD-R JPEG Discs

- Only files with the ".jpg" and ".JPG" extensions can be played.
- If the disc is not closed, it will take longer to start playing and not all of the recorded files may be played.
- Only CD-R discs with JPEG files in ISO 9660 or Joliet format can be played.
- The name of the JPEG file may not be longer than 8 characters and should contain no blank spaces or special characters (. / = +).
- Only a consecutively written multisession disc can be played. If there is a blank segment in the multisession disc, the disc can be played only up to the blank segment.
- A maximum of 500 images can be stored on a single CD.
- Only Kodak Picture CDs can be played.
- When playing a Kodak Picture CD, only the JPEG files in the pictures folder can be played.
- Picture discs other than Kodak Picture CD may take longer to start playing or may not play at all.
- If a number of files in 1 Disc is over 500, only 500 JPEG file can be played.
- If a number of folders in 1 Disc is over 300, only JPEG files in 300 folders can be played.

During DVD/CD playback you can select from the following special playback options. To resume normal playback, press the ►|| button.

1 Still

- Press the ►|| button on the remote control during playback.
- The picture will still and the audio will mute.
- To resume playback, press the ►|| button.
- If the player is left in Still mode for 5 minutes, it will stop automatically.

2 Frame Advance (Step)

While in playback mode, press the 帧进 (F.ADV/STEP) button on the remote control to advance one frame at a time.

- Audio is muted during Frame Advance mode.
- Press ►|| to resume normal playback.

NOTE: Frame Advance operates only in the forward direction.

3 Slow Motion

During playback, press the ►|| button to Still the image. Then use the Search ►► to play in slow motion at variable speeds.

- Each press increases the slow motion speed playback to 1/8, 1/4 or 1/2 normal speed.
- Audio is muted during slow motion playback.

4 Stop/Resume

- Press the ■ button twice to completely stop playback. The next time you press ►||, the disc will start over from the beginning.

5 Zoom





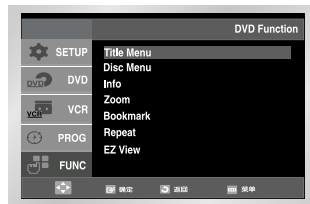

During play, press the 菜单(MENU) button on the remote. Then press the corresponding ▲, ▼ buttons to select the FUNC option.

➤ Auto Scaling : CIF(100kbps)~D1(784kbps) resolution.

If the file resolution is small, it scales up to 2 times automatically. So you can see the more larger screen.



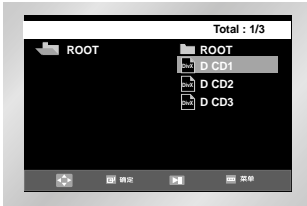

DivX/XviD/MPEG4 Playback

- When the disc is inserted, the file structure of the disc will be shown. Depending on the file format, a different icon will appear next to each file. The , , and  files will have been highlighted. Use ,  to select the movie file, and then press OK or .
Result : When the 'Reading Index.....' message is displayed, wait for a second or two. The movie will be played back.



If the "Codec. Not Supported" message is displayed, the selected file cannot be played back.

- To navigate to a specific time while viewing the movie, press the INFO. key. The file format of the current file (, , or ) and time information will be displayed.
- Use the numeric keys on the remote control to enter the time to jump to that time in the movie.



DivX/XviD/MPEG4 Feature Table

MPEG4 Supported

Avi files are used to contain the audio and video data; these must be stored on CD in the ISO 9660 format.

		SPEC
VIDEO Compatibility	DivX 3.11 upper	Up to the latest VERSION
	XviD	
	WMV(?)	WMV V1/V2/V3/V7
AUDIO Compatability	MP3	CBR : 80kbps~320kbps
	AC3	CBR : 128kbps~448kbps
	AAC(?)	
	WMA	CBR : 56kbps~160kbps

MPEGs containing DivX can be divided into Video and Audio.

- Video compatibility : All versions of DivX later than 3.11 (including the latest 5.1) are supported. In addition, XviD is supported. For WMV, V1, V2, V3, and V7 formats are possible.
- Audio compatibility : MP3s encoded at bitrates from 80kbps to 320kbps, AC3s from 128kbps to 448kbps, and WMAs from 56kbps to 160kbps are supported.
- In addition, for subtitles, Samsung will support Text format (SMI).

Beginning Karaoke Functions

- 1 Connect the Mixed Audio Out terminals with the TV or AMP.
 - 2 Press the STANDBY/ON button.
 - 3 Connect Mic into Mic 1 or Mic 2 jack. Then the karaoke mode is transferred to ON mode.
 - To disconnect the Mic makes the karaoke mode transfer to OFF mode automatically.
-
- This function operates only in DVD, VCD, and CD DISC.
 - This function cannot operate according to the disc type.

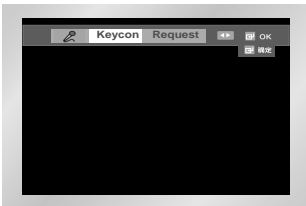

Key Control

- 1 Press the KARAOKE button.
 - 2 Select the "Keycon" using the ◀ or ▶ buttons.
 - 3 By use of the ◀ or ▶ buttons, change to the desired tone.
 - ♭ : To let 7 scales down by half scale.
 - ♮ : Original scale.
 - # : To let 7 scales up by half scale.
-
- This function operates only in DVD, VCD, and CD DISC.
 - This function cannot operate according to the disc type.

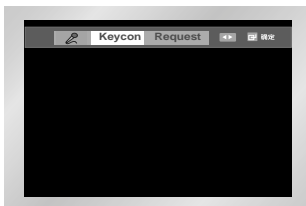

Reserving a Song

It is the function to reserve the desired song in advance by use of Karaoke function.

- 1 Playback the Karaoke Disc containing the wanted songs.
- 2 Press the KARAOKE button on the remote control.
- 3 Select the "Request" using the ◀ or ▶ buttons, then press 确定(OK) button.
- 4 Input the number (Track No.) of the desired song into the flickering part(--).
 - You can reserve up to 10 songs.
- 5 When you want the next reserved song during playing a song, press the ▶▶| button.

-
- When the request is ended, the mode changes to STOP mode.

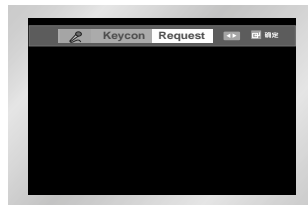

Cancellation of reservation

- 1 Cancel by pressing the 清除(CLEAR) button of the remote.
 - The last reserved song will be erased first.
 - 2 Continuous pressing of the 清除(CLEAR) button can cancel the next reserved song.
 - 3 If the reservation is required again, input the song number in the flickering part.
-
- Request function is available only when the Karaoke mode is "ON".
 - When using "▶▶I" button, it can not work at the last song.
 - When using Request function, the "REPEAT" function does not work.

Vocal Fader

Pressing the 卡拉OK (KARAOKE) button twice displays the following in Karaoke ON mode:

- This function can provide the only melody without specific vocal sound when playing a Karaoke disc.

VOCAL FADER	Remark
V1	CH1. Vocal Cancel
V2	CH2. Vocal Cancel
V1 V2	CH1, CH2. Vocal Cancel
OFF	Vocal Fader Off

- In VCD, CVD or CD, you can select only the L, R, OFF.

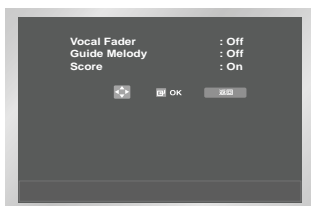

Guide Melody

- To guide melody through xylophone and piano help you sing easily.
- This function works only on the DVD Karaoke disc on which the guide melody is recorded.

Score Function

Press 卡拉OK (KARAOKE) button twice to turn the Score Mode On.

- Score will pop up whenever a song is completed.

Types of Karaoke disc

◆ DVD Karaoke Disc

Channel	Karaoke -Channel	5CH. DVD	2CH. DVD
1 CH	L	Left stereo music	Left stereo music + Vocal
2 CH	R	Right stereo music	Right stereo music + Vocal
3 CH	M	Guide melody	-
4 CH	V1	Vocal track	-
5 CH	V2	Vocal track	-

◆ CVD, VCD Karaoke Disc

Channel	Karaoke -Channel	CVD	VCD, CD
1 CH	CH1 LEFT	Left stereo music+Vocal	Left stereo music
1 CH	CH1 RIGHT	Right stereo music+Vocal	Right stereo music + Vocal
2 CH	CH2 LEFT	Left stereo music	-
2 CH	CH2 RIGHT	Right stereo music	-

* It cannot be done as above picture in accordance with the disc type.

CAUTIONS: Make sure to turn the KARAOKE MODE to OFF to play a movie disc or play in a general mode. If you play a movie disc with the KARAOKE ON, a score will show up every time when a chapter is over.

Technical Specifications

General	Rated voltage	110 - 240V, 50/60Hz
	Power consumption	19 Watts
	Weight	3.8 Kg
	Size	430mm X 282mm X 82mm
	Operating ambient temperature	+5°C ~ +35°C
	Installation conditions	Operation position : Horizontal, Relative humidity : Below 75%
Input	Video input (Rear)	A/V jack : 1.0Vp-p (unbalanced) 75Ω
	Audio input (Rear)	A/V jack : -8dBm, 47Kohm unbalanced
	Mic (front)	2 Mic Input
Output	RF out	UHF 21-69 (Initial CH38)
	Audio (DVD, VCR)	A/V jack
	Audio (DVD only)	Digital audio out (OPTICAL, COAXIAL)
	Video (DVD, VCR)	A/V jack
	Video (DVD only)	S-Video out COMPONENT out : A/V jack
VCR	Tape format	VHS type video tape, S-VHS type video tape (Playback only)
	Color system	PAL, MESECAM, NT 3.58, NTSC4.43, NTSC playback on PAL TV
	Tuning system	B/G, D/K, I
	Video S/N	Above 43dB (standard recording)
	Resolution	Above 240 lines (standard recording)
	Audio S/N	Above 68dB (Hi-Fi), 39dB (Mono)
	Audio frequency characteristics	20Hz - 20KHz (Hi-Fi)
DVD	Disc	DVD, CD (12cm), CD (8cm), VIDEO-CD (12cm)
	Audio S/N	95dB
	Audio dynamic range	105dB

Problems and Solutions (VCR)

Before contacting the Samsung after-sales service, perform the following simple checks.

Problem	Explanation/Solution
No power	<ul style="list-style-type: none"> ◆ Check that the power plug is connected to a wall outlet. ◆ Have you pressed the 待机(STANDBY/ON) button?
You cannot insert a video cassette	<ul style="list-style-type: none"> ◆ A video cassette can only be inserted with the window side up and the safety tab facing you.
The television programme was not recorded	<ul style="list-style-type: none"> ◆ Check the DVD-VCR aerial connections. ◆ Is the DVD-VCR tuner properly set? ◆ Check if the safety tab is intact on the cassette.
Timer recording was unsuccessful	<ul style="list-style-type: none"> ◆ Was the 待机(STANDBY/ON) button pressed to activate the timer? ◆ Re-check the recording start/stop time settings. ◆ If there was a power failure or interruption during timer recording, the recording will have been cancelled.
No playback picture or the picture is distorted	<ul style="list-style-type: none"> ◆ Check to see if you are using a prerecorded tape.
You cannot see normal broadcasts	<ul style="list-style-type: none"> ◆ Check the TUNER/EXTERNAL setting. It should be on TUNER. ◆ Check the TV/VCR aerial connections.
Noise bars or streaks on playback	<ul style="list-style-type: none"> ◆ Press the 磁迹跟踪(TRK) (∧ or ∨) buttons to minimize this effect.
When the ► button is pressed during playback, the still picture	<ul style="list-style-type: none"> ◆ A still picture may have “noise bars”, depending on the condition of the tape. Press the 磁迹跟踪(TRK) (∧ or ∨) buttons has severe “noise bars” streaks during SLOW motion to minimize this effect.
Video Head Cleaning	<ul style="list-style-type: none"> ◆ If poor pictures appear on a variety of cassettes, the video heads may need cleaning. This is not a common problem and unless it appears, the heads should not be cleaned. When cleaning the video heads, read all instructions provided with the head cleaning cassette. Incorrect head cleaning can permanently damage the video heads.
If when tuning in your TV to the DVD-VCR TV does not find the Screen or the pattern when found suffers from interference, it may be due to the DVD-VCR output channel clashing with the normal TV transmissions in your area. To prevent this you will need to change the DVD-VCR output channel in the following way	<ol style="list-style-type: none"> 1. Remove the aerial input plug from the socket marked (aerial symbol) on the rear of the DVD-VCR. 2. Carry out the instructions “Tuning Your Television for the DVD-VCR” (see page 9). 3. Carry out the instructions “Setting the DVD-VCR output Channel” (see page 14), move the channel number several channels down from the original setting. (example: from 36 to 37). 4. Replace the aerial plug into the socket marked (aerial symbol) on the rear of the DVD-VCR. 5. Re-tune your TV to the DVD-VCR again by following instructions “Tuning Your Television for the DVD-VCR” (page 9). 6. If the problem still exists repeat steps 1 to 5 moving several more channels away from the original setting.

If you are unable to solve the problem after reading the above instructions, note:

- ◆ The model and serial number on the rear of your DVD-VCR
- ◆ The warranty information
- ◆ A clear description of the problem

Then contact your nearest SAMSUNG after-sales service.

Troubleshooting Guide (DVD)

Before requesting service (troubleshooting)

Problem	Action	Page
Disc does not play.	<ul style="list-style-type: none"> ◆ Ensure that the disc is installed with the label side facing up. ◆ Check the region number of the DVD. ◆ This player cannot play CD-ROMs, DVD-ROMs, etc. Insert a DVD, a VIDEO-CD or a CD. 	P4
5.1 channel sound is not being reproduced.	<ul style="list-style-type: none"> ◆ 5.1 channel sound is reproduced only when the following conditions are met. : <ol style="list-style-type: none"> 1) The DVD-VCR player is connected with the proper amplifier 2) The disc is recorded with 5.1 channel sound. ◆ Check whether the disc being played has the "Dolby 5.1 ch" mark on the outside. ◆ Check if your audio system is connected and working properly. 	P27
The  icon appears on screen.	<ul style="list-style-type: none"> ◆ The features or action cannot be completed at this time because: <ol style="list-style-type: none"> 1. The DVD's software restricts it. 2. The DVD's software doesn't support the feature (e.g., angles). 3. The feature is not available at the moment. 4. You've requested a title or chapter number or search time that is out of range. 	P30-37
Playback mode differs from the Setup Menu selection.	<ul style="list-style-type: none"> ◆ Some of the functions selected in the Setup Menu may not work properly if the disc is not encoded with the corresponding function. 	P25-29
The screen ratio cannot be changed.	<ul style="list-style-type: none"> ◆ The Screen Ratio is fixed on your DVDs. 	P28
No audio.	<ul style="list-style-type: none"> ◆ Make sure you have selected the correct Digital Output in the Audio Options Menu. 	P27
Forgot password	<ul style="list-style-type: none"> ◆ Press STANDBY/ON from a cold start with no disc in the unit. Press the ◀ and ▶ buttons simultaneously on the front panel for five seconds. Switch off and on the DVD-VCR by pressing 待机(STANDBY/ON) button. The Parental Mode is now unlocked as indicated on the display. You can now set your rating level and change your password to a new number. 	
If you experience other problems.	<ul style="list-style-type: none"> ◆ Go to the contents and find the section of the instruction book that contains the explanations regarding the current problem, and follow the procedure once again. ◆ If the problem still cannot be solved, please contact your nearest authorized service center. 	

THIS APPLIANCE IS DISTRIBUTED BY

