



**DVD Player**  
**DVD-P4444**  
**DVD-P4545K**





## General Features

### Excellent Sound

Dolby Digital, a technology developed by Dolby Laboratories provides crystal clear sound reproduction.

### Screen

Video with MPEG-2 compression technology. Both regular and widescreen(16:9) pictures can be viewed.

### Slow Motion

An important scene can be viewed in slow motion.

### Programmed Play (CD)

You can program tracks to play in desired order.

### Parental Control (DVD)

The parental control allows users to set the level necessary to prohibit children from viewing harmful movies such as those with violence, adult subject matter, etc.

### Various On-Screen Menu Functions

You can select various languages (Audio/Subtitle) and screen angles while enjoying movies.

### EZ VIEW (DVD)

Easy View can convert Letter Box images to full screen viewing on your conventional TV.

### Digital Photo Viewer (JPEG)

You can view the Digital Photos on your TV.

### Repeat

You can repeat a song or movie simply by pressing the REPEAT button.

### MP3/WMA

This unit can play discs created from MP3/WMA files.

### Instant Replay (DVD)

This function is used to replay the previous 10 seconds of a movie from the current position.

### Instant Skip (DVD)

This function skips playback ahead 10 seconds.

### Note

\* Discs which cannot be played with this player.

- DVD-ROM
- DVD-RAM
- CD-ROM
- CDV
- CDI
- HD layer of super Audio CD
- CDGs play audio only, not graphics.

\* Ability to play back may depend on recording conditions.

- DVD-R, +R
- CD-RW
- DVD+RW, -RW

\* It may not play CD-R, CD-RW and DVD-R in all cases due to the type of disc or condition of the recording.

### COPY PROTECTION

Many DVD discs are encoded with copy protection. Because of this, you should only connect your DVD player directly to your TV, not to a VCR. Connecting to a VCR results in a distorted picture from copy-protected DVD discs.



This product incorporates copyright protection technology that is protected by methods claims of certain U.S. patents and other intellectual property rights owned by Macrovision Corporation and other rights owners. Use of this copyright protection technology must be authorized by Macrovision Corporation, and is intended for home and other limited viewing uses only unless otherwise authorized by Macrovision Corporation. Reverse engineering or disassembly is prohibited.

### PROGRESSIVE SCAN OUTPUTS (525p/625p)







"CONSUMERS SHOULD NOTE THAT NOT ALL HIGH DEFINITION TELEVISION SETS ARE FULLY COMPATIBLE WITH THIS PRODUCT AND MAY CAUSE ARTIFACTS TO BE DISPLAYED IN THE PICTURE, IN CASE OF 525 OR 625 PROGRESSIVE SCAN PICTURE PROBLEMS, IT IS RECOMMENDED THAT THE USER SWITCH THE CONNECTION TO THE 'STANDARD DEFINITION' OUTPUT. IF THERE ARE QUESTIONS REGARDING OUR TV SET COMPATIBILITY WITH THIS MODEL 525p AND 625p DVD PLAYER, PLEASE CONTACT OUR CUSTOMER SERVICE CENTER."

## Disc Type and Characteristics

This DVD player is capable of playing the following types of discs with the corresponding logos:

Disc Types (Logos)	Recording Types	Disc Size	Max. Playing Time	Characteristics
<b>DVD</b> 	Audio + Video	12 Cm	Single-sided 240 min. Double-sided 480 min.	<ul style="list-style-type: none"> <li>• DVD contains excellent sound and video due to Dolby Digital and MPEG-2 system.</li> <li>• Various screen and audio functions can be easily selected through the on-screen menu.</li> </ul>
		8 Cm	Single-sided 80 min. Double-sided 160 min.	
<b>VIDEO-CD</b> 	Audio + Video	12 Cm	74 min.	<ul style="list-style-type: none"> <li>• Video with CD sound, VHS quality &amp; MPEG-1 compression technology.</li> </ul>
		8 Cm	20 min.	
<b>AUDIO-CD</b> 	Audio	12 Cm	74 min.	<ul style="list-style-type: none"> <li>• CD is recorded as a Digital Signal with better audio quality, less distortion and less deterioration of audio quality over time.</li> </ul>
		8 Cm	20 min.	

### Disc Markings

	Play Region Number
	PAL broadcast system in U.K, France, Germany, etc.
	Dolby Digital disc
	Stereo disc
	Digital Audio disc
	DTS disc
	MP3 disc

### Play Region Number

Both the DVD player and the discs are coded by region. These regional codes must match in order for the disc to play. If the codes do not match, the disc will not play.

**The Region Number for this player is described on the rear panel of the player.**

## Description-Front Panel

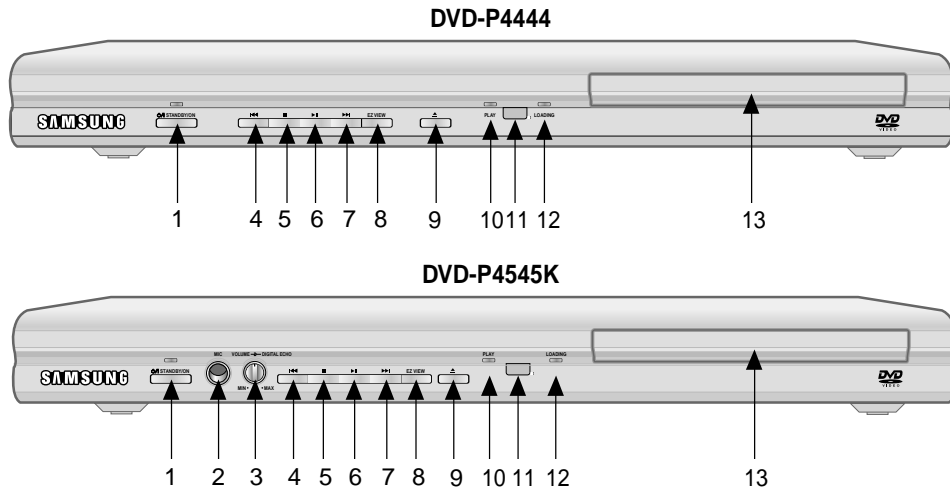

### Front Panel Controls

#### 1. STANDBY/ON ( ⏻ )

- When the player is plugged in, the Power LED lights. If you press the STANDBY/ON button to turn on the player, the LED goes out.

#### 2. MIC

- Connect Microphone for karaoke functions.

#### 3. MICROPHONE VOLUME / DIGITAL ECHO

- Use to adjust microphone volume level and echo delay.

#### 4. SKIP ( ⏮ ) / SEARCH

- Allow you to search backward through a disc. Use to skip the title, chapter or track.

#### 5. STOP ( ■ )

- Stops disc play.

#### 6. PLAY/PAUSE ( ⏪ )

- Begin or pause disc play.

#### 7. SKIP ( ⏭ ) / SEARCH

- Allow you to search forward through a disc. Use to skip the title, chapter or track.

#### 8. EZ VIEW

- Easy View can convert Letter Box images to full screen viewing on your conventional TV.

#### 8. OPEN/CLOSE ( ▲ )

- Press to open and close the disc tray.

#### 10. PLAY LED

- When playing the disc, the Play LED lights.

#### 11. REMOCON RECEIVER

#### 12. LOADING LED

- When loading the disc, the Loading LED lights.

#### 13. DISC TRAY

- Place the disc here.

Function \ LED	Power LED (Red)	Play LED (Green)	Loading LED (Orange)
Power off/Standby	O	X	X
No disc	X	X	O
Stop	X	X	O
Loading	X	X	Blinks
Play/Skip	X	O	X
Search/Pause	X	Blinks	X
Error	Blinks	Blinks	Blinks

## Description-Rear Panel

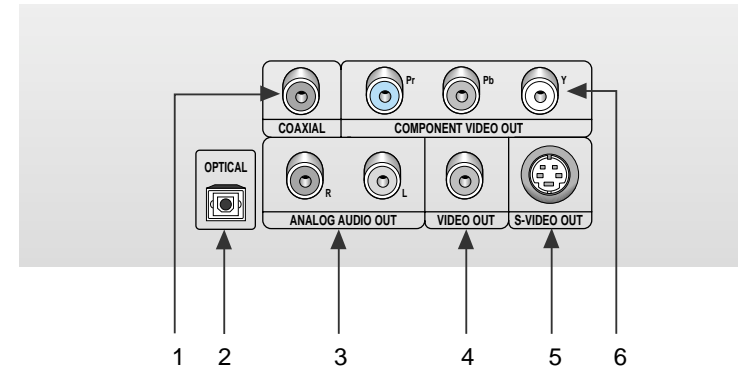

### Rear Panel

#### 1. DIGITAL AUDIO OUT JACKS

- Use either a coaxial digital cable to connect to a compatible Dolby Digital receiver. Use to connect to an A/V Amplifier that contains a Dolby Digital, MPEG-2 or DTS decoder.

#### 2. DIGITAL AUDIO OUT JACKS (DVD-P4545K only)

- Use either a optical cable to connect to a compatible Dolby Digital receiver. Use to connect to an A/V Amplifier that contains a Dolby Digital, MPEG-2 or DTS decoder.

#### 3. ANALOG AUDIO OUT JACKS

- Connect to the Audio input jacks of your television, audio/video receiver.

#### 4. VIDEO OUT JACK

- Use a video cable to connect to the Video input jack on your television.
- The Video Output in Setup Menu must be set to Component(I-SCAN) or S-Video.

#### 5. S-VIDEO OUT JACK

- Use the S-Video cable to connect this jack to the S-Video jack on your television for a higher picture quality.
- The Video Output in Setup Menu must be set to S-Video.

#### 6. COMPONENT VIDEO OUT JACKS

- Use these jacks if you have a TV with Component Video in jacks. These jacks provide Pr, Pb and Y video.
- If Component(P-SCAN) Video Output is selected in Setup Menu, progressive scan mode will work.
- If Component(I-SCAN) Video Output is selected in Setup Menu, interlaced scan mode will work.

### Important Note

- Consult your TV User's Manual to find out if your TV supports Progressive Scan. If Progressive Scan is supported, follow the TV User's Manual's instructions regarding Progressive Scan settings in the TV's menu system.
- If Component(P-SCAN) Video Output is selected in Setup Menu, Video and S-Video will not work.
- See page 31 to get more information on how to use the Setup Menu.

## Tour of the Remote Control

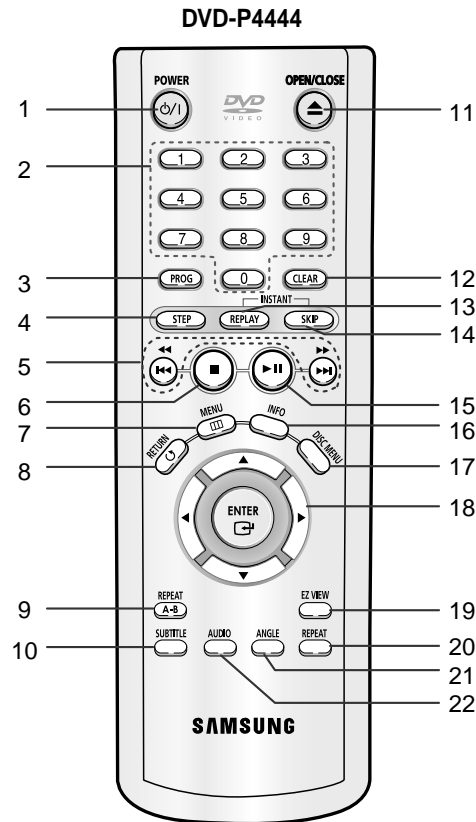

### 6. STOP Button ( ■ )

### 7. MENU Button

- Brings up the DVD player's menu.

### 8. RETURN Button

- Returns to a previous menu.

### 9. REPEAT A-B Button

- Use to mark a segment to repeat between A and B.

### 10. SUBTITLE Button

### 11. OPEN/CLOSE ( ▲ ) Button

- To open and close the disc tray.

### 12. CLEAR Button

- Use to remove menus or status displays from the screen.

### 13. INSTANT REPLAY Button

- This function is used to replay the previous 10 seconds of a movie from the current position.

### 14. INSTANT SKIP Button

- This function skips playback ahead 10 seconds.

### 15. PLAY/PAUSE Button ( ▶|| )

- Begin/Pause disc play.

### 16. INFO Button

- Displays the current disc mode.

### 17. DISC MENU Button

- Brings up the Disc menu.

### 18. ENTER/DIRECTION Button (UP/DOWN or LEFT/RIGHT Buttons)

- This button functions as a toggle switch.

### 19. EZ VIEW Button

- Easy View can convert Letter Box images to full screen viewing on your conventional TV.

### 20. REPEAT Button

- Allows you to repeat play a title, chapter, track, or disc.

### 21. ANGLE Button

- Use to access various camera angles on a DVD.

### 22. AUDIO Button

- Use this button to access various audio functions on a disc.

### DVD Function Buttons

#### 1. DVD POWER Button

- Turns the power on or off.

#### 2. NUMBER Buttons

#### 3. PROG Button

- Allows you to program a specific order.

#### 4. STEP Button

- Advances play one frame at a time.

#### 5. SEARCH/SKIP Buttons ( ◀ / ▶, ◀◀ / ▶▶ )

- Allow you to search forward/backward through a disc. Use to skip the title, chapter or track.

## Tour of the Remote Control

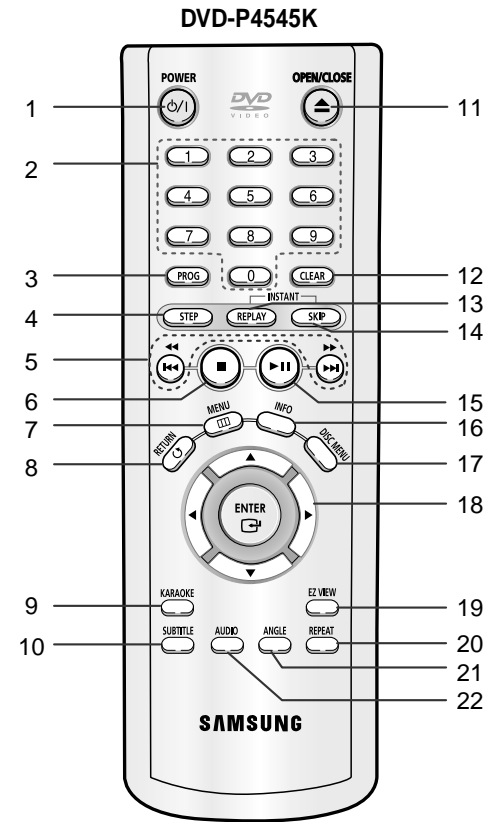

### 6. STOP Button ( ■ )

### 7. MENU Button

- Brings up the DVD player's menu.

### 8. RETURN Button

- Returns to a previous menu.

### 9. KARAOKE Button

- Use to begin Karaoke functions.

### 10. SUBTITLE Button

### 11. OPEN/CLOSE ( ▲ ) Button

- To open and close the disc tray.

### 12. CLEAR Button

- Use to remove menus or status displays from the screen.

### 13. INSTANT REPLAY Button

- This function is used to replay the previous 10 seconds of the movie from the current position.

### 14. INSTANT SKIP Button

- This function skips playback ahead 10 seconds.

### 15. PLAY/PAUSE Button ( ▶|| )

- Begin/Pause disc play.

### 16. INFO Button

- Displays the current disc mode.

### 17. DISC MENU Button

- Brings up the Disc menu.

### 18. ENTER/DIRECTION Button (UP/DOWN or LEFT/RIGHT Buttons)

- This button functions as a toggle switch.

### 19. EZ VIEW Button

- Easy View can convert Letter Box images to full screen viewing on your conventional TV.

### 20. REPEAT Button

- Allows you to repeat play a title, chapter, track, or disc.

### 21. ANGLE Button

- Use to access various camera angles on a DVD.

### 22. AUDIO Button

- Use this button to access various audio functions on a disc.

### DVD Function Buttons

#### 1. DVD POWER Button

- Turns the power on or off.

#### 2. NUMBER Buttons

#### 3. PROG Button

- Allows you to program a specific order.

#### 4. STEP Button

- Advances play one frame at a time.

#### 5. SEARCH/SKIP Buttons ( ◀ / ▶, ◀◀ / ▶▶ )

- Allows you to search forward/backward through a disc. Use to skip the title, chapter or track.

## Choosing a Connection

The following shows examples of connections commonly used to connect the DVD player with a TV and other components.

### Before Connecting the DVD Player

- Always turn off the DVD player, TV, and other components before you connect or disconnect any cables.
- Refer to the owner's manual of the additional components you are connecting for more information on those particular components.

### Connection to an Audio

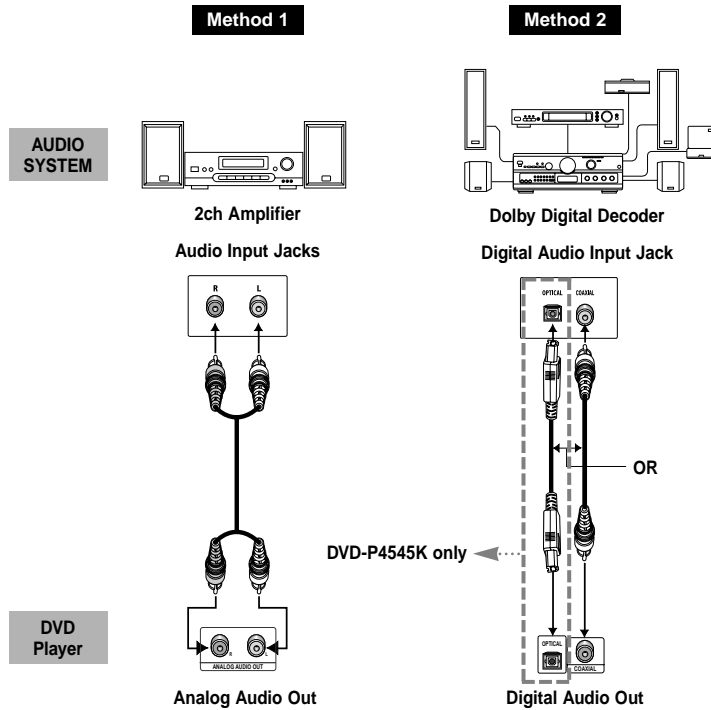

### An Example of Connecting DVD with Other Equipment

#### Method 1

DVD Player + 2ch Stereo Amplifier or Dolby Pro Logic Decoder

#### Method 2

DVD Player + Amplifier with Dolby Digital Decoder/DTS Decoder/MPEG-2

## Choosing a Connection

### Connection to a TV (For Video)

TV (Normal, Widescreen, Projection, etc..)

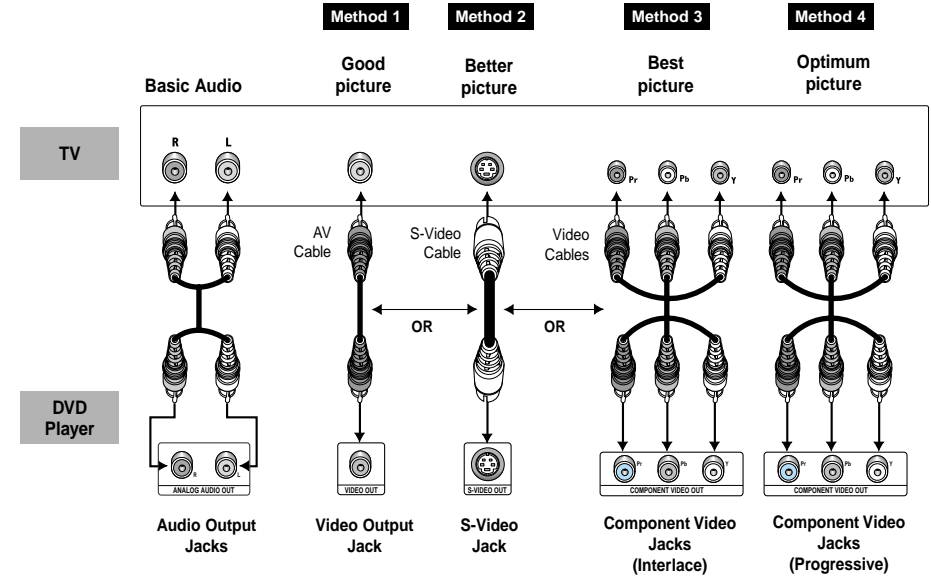

#### Method 1

DVD Player + TV with Video Input Jack  
(The Video Output in Setup Menu must be set to S-Video or Component(I-SCAN).)

#### Method 2

DVD Player + TV with S-Video Input Jack  
(The Video Output in Setup Menu must be set to S-Video.)

#### Method 3

DVD Player + TV with interlace Scan Component Video Jacks  
(The Video Output in Setup Menu must be set to Component(I-SCAN).)

#### Method 4

DVD Player + TV with Progressive Scan Component Video Jacks.  
(The Video Output in Setup Menu must be set to the Component(P-SCAN).)

- If you want to convert Video Output to Progressive Scan, you have to first connect Video or S-Video on your TV. Then select Component(P-SCAN)(480p) Video Output in Setup Menu. Within 10 seconds, change the TV's external input to 525p(480p or Component) and select "Yes" (See Page 31).
- If Component(P-SCAN) Video Output is selected in Setup Menu, Video(Composite) and S-Video will not work.

### Important Note

- Consult your TV User's Manual to find out if your TV supports Progressive Scan. If Progressive Scan is supported, follow the TV User's Manual's instructions regarding Progressive Scan settings in the TV's menu system.
- Depending on your TV, the Method of connection may differ from the illustration above.

## Playing a Disc

### Before Play

- Turn on your TV and set it to the correct Video Input by pressing TV/VIDEO button on the TV remote control.
- If you connected an external Audio System, turn on your Audio System and set it to the correct Audio Input.

After plugging in the player, the first time you press the DVD POWER button, this screen comes up : If you want to select the language, press a NUMBER button. (This screen will only appear when you plug in the player for the first time.) If you don't select language, at first time, setting value of Setup menu will be lost.



### Play

1. Press the OPEN/CLOSE button.  
The STANDBY indicator light goes out and the tray opens.
2. Place a disc gently into the tray with the disc's label facing up.
3. Press the PLAY/PAUSE (▶||) button or OPEN/CLOSE button to close the disc tray.
4. Stopping Play  
Press the STOP (■) button during play.
5. Removing Disc  
Press the OPEN/CLOSE button.
6. Pausing Play  
Press the PLAY/PAUSE (▶||) or STEP button on the remote during play.
  - Screen stops, no sound.
  - To resume, press the PLAY/PAUSE (▶||) button once again.

### 7. Step Motion Play (Except CD)

- Press the STEP button on the remote during play.
- Each time the button is pressed, a new frame will appear.
  - No sound is heard during STEP mode.
  - Press the PLAY/PAUSE (▶||) button to resume normal play. (You can only perform step motion play in the forward direction.)

### 8. Slow Motion Play (Except CD)

- Press and hold the ▶▶ button to choose the play speed between 1/8, 1/4 and 1/2 of normal during PAUSE or STEP mode.
- No sound is heard during slow mode.
  - Press the PLAY/PAUSE (▶||) button to resume normal play.
  - Reverse slow motion play will not work.

### RESUME function

When you stop disc play, the player remembers where you stopped, so when you press PLAY (▶||) again, it will pick up where you left off. (unless the disc is removed or the player is unplugged, or if you press the STOP (■) button twice.)

### Note

- If the player is left for about 5 minutes in pause mode, it will stop.
- If the player is left in the stop mode for more than about 30 minutes, the power will automatically shut off. (Automatic Power-Off Function) (DVD-P4444 Only)
- If the player is left in the stop mode for more than one minute without any user interaction, a screen saver will be activated. Press the PLAY/PAUSE (▶||) button to resume normal play.
- This ⓪ icon indicates an invalid button press.

## Using the Search & Skip Functions

During play, you can search quickly through a chapter or track or use the skip function to jump to the next selection.

### Searching through a Chapter or Track

Press the SEARCH (◀◀ or ▶▶) button on the remote for more than 1 second.  
If you want to search at a faster speed on the DVD, VCD or CD, press and hold the button.

DVD	2X, 8X, 32X, 128X
VCD	4X, 8X
CD	2X, 4X, 8X

### Skipping Tracks

During play, press the ◀◀ or ▶▶ button.

- When playing a DVD, if you press the ▶▶ button, it moves to the next chapter. If you press the ◀◀ button, it moves to the beginning of the chapter. One more press makes it move to the beginning of the previous chapter.
- When playing a VCD 2.0 in MENU OFF mode, a CD, if you press the ▶▶ button, it moves to the next track. If you press the ◀◀ button, it moves to the beginning of the previous track.
- When playing a VCD 2.0 in MENU OFF mode, if a track exceeds 15 minutes when playing a VCD and you press the ▶▶ button, it moves forward 5 minutes. If you press the ◀◀ button, it moves backward 5 minutes.

### Note

\* When playing a VCD 2.0, you can choose MENU ON or MENU OFF by using the DISC MENU button.

## Using the Display Function

### When Playing a DVD/VCD/CD

1. During play, press the INFO button on the remote.
2. Use the UP/DOWN buttons to select the desired item.
3. Use the LEFT/RIGHT buttons to make the desired setup and then press ENTER.
  - You may use the number buttons of the remote control to directly access a title, chapter or to start the playback from the desired time.
4. To make the screen disappear, press the INFO button again.

### DVD

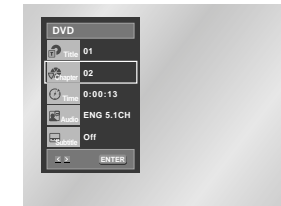

### VCD

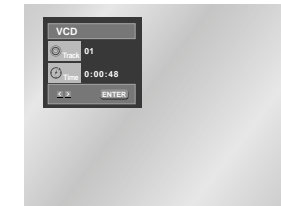

### CD



## Using the Display Function



To access the desired title when there is more than one in the disc. For example, if there is more than one movie on a DVD, each movie will be identified.



Most DVD discs are recorded in chapters so that you can quickly find a specific passage (similar to tracks on an audio CD).



Allows playback of the film from a desired time. You must enter the starting time as a reference.



Refers to the language of the film soundtrack. In the example, the soundtrack is played in English 5.1CH. A DVD disc can have up to eight different soundtracks.



Refers to the subtitle languages available in the disc. You will be able to choose the subtitle languages or, if you prefer, turn them off from the screen. A DVD disc can have up to 32 different subtitles.

### Note

\* When in VCD 2.0 mode (MENU ON mode), this function does not work. (See page 13)

## Using the Disc and Title Menu

### Using the Disc Menu

1. During the playback of a DVD disc, press the MENU button on the remote.
2. Select **Disc Menu** using the UP/DOWN buttons, then press the RIGHT or ENTER button.



### Using the Title Menu

1. During the playback of a DVD disc, press the MENU button on the remote.
2. Select **Title Menu** using the UP/DOWN buttons, then press the RIGHT or ENTER button.



### Note

- Depending on the disc, the Title and Disc Menus may not work.
- Title Menu will only be displayed if there are at least two titles in the disc.
- You can also use the Disc Menu, using the DISC MENU button on the remote.
- In VCD 2.0, the DISC MENU button is used to select Menu On or Menu Off mode.

## Using the Function Menu

### Using the Function Menu

1. Press the MENU button during playback.
2. Use the UP/DOWN buttons to highlight **Function**, then press the RIGHT or ENTER button.
3. Function selection screen appears: Info, Zoom, Bookmark, Repeat and EZ View.
  - Info (See Page 13-14)
  - Zoom (See Page 21)
  - Bookmark (See Page 20)
  - Repeat (See Page 15)
  - EZ View (See Page 17)
4. Use the UP/DOWN button to highlight one of the 5 functions. Then press the RIGHT or ENTER button to access the function.

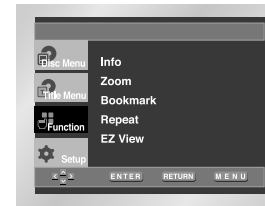

### Note

- You can also directly select the parts of these functions using their respective buttons on the remote.

## Repeat Play

Repeat the current track, chapter, title, a chosen section (A-B), or all of the disc.

### When playing a DVD/VCD/CD

1. Press the REPEAT button on the remote. Repeat screen appears.
2. Select Chapter, Title or A-B using the LEFT/RIGHT buttons.
  - Chapter (⌂) : repeats the chapter that is playing.
  - Title (📄) : repeats the title that is playing.
  - A-B : repeats a segment of the disc that you select.

### DVD



### VCD/CD



3. Press ENTER.
4. To return to normal play, press REPEAT again, then press the LEFT/RIGHT buttons to select Off and press ENTER.

- \* A-B REPEAT (DVD-P4444 only)
- Press the REPEAT A-B button to select the point where the function starts. (A)
- Press the REPEAT A-B button to select the point where the function ends. (B)
- To terminate the function, press the 'CLEAR' button or the 'REPEAT A-B' button again.
- A-B REPEAT does not allow you to set point (B) until at least 5 seconds has elapsed after point (A) has been set.

### Note

- DVD repeats play by chapter or title, CD and VCD repeat play by disc or track.
- Depending on the disc, the Repeat function may not work.
- When in VCD 2.0 mode (MENU ON mode), this function does not work. (See page 13)



## Program Play & Random Play

### Program Play (CD)

1. Press the PROG button.
2. Use the LEFT/RIGHT buttons to select PROGRAM. Press the ENTER button.
3. Use the LEFT/RIGHT/UP/DOWN buttons to select the first track to add to the program. Press the ENTER button. The selection numbers appear in the Program Order box.
4. Press the PLAY/PAUSE (▶||) button. The disc will be played in programmed order.

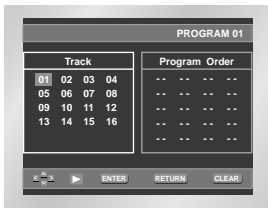

### Random Play (CD)

1. Press the PROG button.
2. Use the LEFT/RIGHT buttons to select RANDOM. Press the ENTER button.



### Note

- Depending on the disc, the Program and Random Play functions may not work.
- This unit can support a maximum of 20 programmed tracks.
- While in playback mode, press the CLEAR button on the remote control to cancel Programmed Play or Random Play.

## Slow Repeat play

This feature allows you slowly to repeat scenes containing sports, dancing, musical instruments being played etc. so you can study them more closely.

### When playing a DVD/VCD

1. During play, press the PLAY/PAUSE (▶||) button.
2. Press and hold the ▶▶ button to choose the play speed between 1/8, 1/4, and 1/2 of normal during PAUSE or STEP mode.
3. Press the REPEAT button on the remote. Repeat screen appears.
4. Select A-B using the LEFT/RIGHT buttons.
5. Press the ENTER button to select the point where the function starts. (A)
6. Press the ENTER button to select the point where the function ends. (B)
7. To return to normal play, press REPEAT again, then press the LEFT/RIGHT buttons to select Off and press ENTER.

\* REPEAT A-B (DVD-P4444 only)

- Press the REPEAT A-B button to select the point where the function starts. (A)
- Press the REPEAT A-B button to select the point where the function ends. (B)
- To terminate the function, press the 'CLEAR' button or the 'REPEAT A-B' button again.

### Note

- The disc will play from A to B repeatedly at the speed you chose.
- To terminate the function, press the CLEAR button.
- A-B REPEAT does not allow you to set point (B) until at least 5 seconds has elapsed after point (A) has been set.
- When in VCD 2.0 mode (MENU ON mode), this function does not work. (See page 13)

## Adjusting the Aspect Ratio (EZ View)

### To play back using aspect ratio (DVD)

Press the EZ VIEW button.

- The screen size changes when the button is pressed repeatedly.
- The screen zoom mode operates differently depending on the screen setting in the initial setup menu.
- To ensure correct operation of the EZ VIEW button, you should set the correct aspect ratio in the initial setup (See page 30).

### If you are using a 16:9 TV

#### 1. For 16:9 aspect ratio discs

- **Wide Screen**  
Displays the content of the DVD title in 16:9 aspect ratio.
- **Screen Fit**  
The top and bottom of the screen are cut off. When playing a 2.35:1 aspect ratio disc, the black bars at the top and bottom of the screen will disappear. The picture will look vertically stretched. (Depending on the type of disc, the black bars may not disappear completely.)
- **Zoom Fit**  
The top, bottom, left and right of the screen are cut off and the central portion of the screen is enlarged.

#### 2. For 4:3 aspect ratio discs

- **Normal Wide**  
Displays the content of the DVD title in 16:9 aspect ratio. The picture will look horizontally stretched.
- **Screen Fit**  
The top and bottom of the screen are cut off and the full screen appears. The picture will look vertically stretched.
- **Zoom Fit**  
The top, bottom, left and right of the screen are cut off and the central portion of the screen is enlarged.
- **Vertical Fit**  
When a 4:3 DVD is viewed on a 16:9 TV, black bars will appear at the left and right of the screen in order to prevent the picture from looking horizontally stretched.

### If you are using a 4:3 TV

#### 1. For 16:9 aspect ratio discs

- **4:3 Letter Box**  
Displays the content of the DVD title in 16:9 aspect ratio. The black bars will appear at the top and bottom of the screen.
- **4:3 Pan Scan**  
The left and right of the screen are cut off and displays the central portion of the 16:9 screen.
- **Screen Fit**  
The top and bottom of the screen are cut off and the full screen appears. The picture will look vertically stretched.
- **Zoom Fit**  
The top, bottom, left and right of the screen are cut off and the central portion of the screen is enlarged.

#### 2. For 4:3 aspect ratio discs

- **Normal Screen**  
Displays the content of the DVD title in 4:3 aspect ratio.
- **Screen Fit**  
The top and bottom of the screen are cut off and the full screen appears. The picture would look vertically stretched.
- **Zoom Fit**  
The top, bottom, left and right of the screen are cut off and the central portion of the screen is enlarged.

### Note

- This function may behave differently depending on the type of disc.

## Selecting the Audio Language

You can select a desired language quickly and easily with the AUDIO button.

### **Using the AUDIO button**

1. Press the AUDIO button.
2. The Audio changes when the button is pressed repeatedly.
  - The audio languages are represented by abbreviations.
3. Press the AUDIO button to select Stereo, Left or Right. (On VCD/CD)

#### DVD



#### VCD/CD

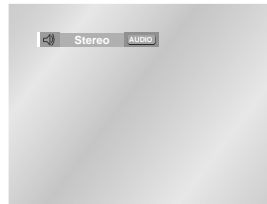

### **Note**

- This function depends on what languages are encoded on the disc and may not work with all DVDs.
- A DVD disc can contain up to 8 audio languages.
- **How to have the same audio language come up whenever you play a DVD;** Refer to "Setting Up the Language Features" on page 28.

## Selecting the Subtitle Language

You can select a desired subtitle quickly and easily with the SUBTITLE button.

### **Using the SUBTITLE button**

1. Press the SUBTITLE button.
2. The subtitle changes when the button is pressed repeatedly.
3. To turn off the display, press the CLEAR or RETURN button.
  - Initially, the subtitle will not appear on screen.
  - The subtitle languages are represented by abbreviations.



### **Note**

- This function depends on what languages are encoded on the disc and may not work with all DVDs.
- A DVD disc can contain up to 32 subtitle languages.
- **How to have the same subtitle language come up whenever you play a DVD;** Refer to "Setting Up the Language Features" on page 28.

## Changing the Camera Angle

When a DVD contains multiple angles of a particular scene, you can select the Angle function.

### **Using the ANGLE button**

If the disc contains multiple angles, the ANGLE mark appears on the screen.

1. Press the ANGLE button, then ANGLE icon will appear with the current angle number and the number of angles available.
2. Press the ANGLE button repeatedly to the desired angle.
3. To remove the ANGLE icon, press the CLEAR or RETURN button.

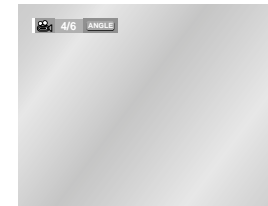

### **Note**

- If the disc has only one angle, this feature won't work. Currently, very few discs have this feature.

## Using the Instant Replay/Skip Function

### **Using the Instant Replay function (DVD)**

**If you miss a scene, you can see it again using this function.**

If you press the INSTANT REPLAY button, the current scene moves backward about 10 seconds, and plays back.

\* Depending on the disc, the Instant Replay function may not work.

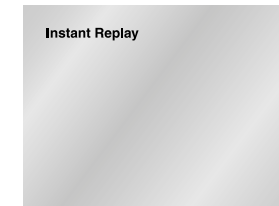

### **Using the Instant Skip function (DVD)**

**Use this function to skip playback about 10 seconds ahead of the current scene.**

Press the INSTANT SKIP button.

- Playback will skip ahead 10 seconds.
- Depending on the disc, this function may not work.

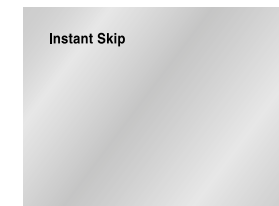

## Using the Bookmark Function

This feature lets you bookmark sections of a DVD or VCD (Menu Off mode) so you can quickly find them at a later time.

### Using the Bookmark Function (DVD/VCD)

1. During play, press the MENU button on the remote.
2. Use the UP/DOWN buttons to highlight **Function**, then press the RIGHT or ENTER button.
3. Select **Bookmark** using the UP/DOWN buttons, then press the RIGHT or ENTER button.
4. Use the LEFT/RIGHT buttons to move to the desired bookmark icon.
5. When you reach the scene you want to mark, press the ENTER button. The icon will change to a number (1, 2, or 3).

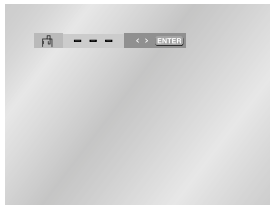
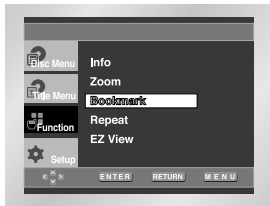

### Recalling a Marked Scene

1. During play, press the MENU button on the remote and select the **Bookmark**.
2. Use the LEFT/RIGHT buttons to select a marked scene.
3. Press the PLAY/PAUSE (▶||) buttons to skip to the marked scene.



### Clearing a Bookmark

1. During play, press the MENU button on the remote and select the **Bookmark**.
2. Use the LEFT/RIGHT buttons to select the bookmark number you want to delete.
3. Press the CLEAR button to delete a bookmark number.

### Note

- Up to three scenes may be marked at a time.
- When in VCD 2.0 mode (MENU ON mode), this function does not work. (See page 13)
- Depending on the disc, the Bookmark function may not work.

## Using the Zoom Function

### Using the Zoom Function (DVD/VCD)

1. During play or pause mode, press the MENU button on the remote.
2. Use the UP/DOWN buttons to highlight **Function**, then press the RIGHT or ENTER button.
3. Select **Zoom** using the UP/DOWN buttons, then press the RIGHT or ENTER button.
4. Use the UP/DOWN or LEFT/RIGHT buttons to select the part of the screen you want to zoom in on.
5. Press the ENTER button.
  - During DVD play, press ENTER to zoom in 2X/4X/2X/Normal in order.
  - During VCD play, press ENTER to zoom in 2X/Normal in order.

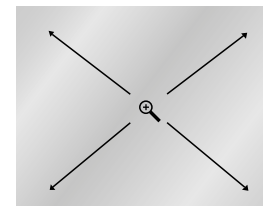

## Clips Menu for MP3/WMA/JPEG

Discs with MP3/WMA/JPEG contain individual songs or pictures that can be organized into folders as shown below. They are similar to how you use your computer to put files into different folders.

1. Open the disc tray.
2. Place the disc on the tray.
  - Place the disc with the labeled side up.
3. Close the tray.
  - The tray closes and you should get a screen that looks like the one below.



Parent Folder, Current Folder and Peer Folders  
Folders and Files in Current Folder

- : Name of currently playing file.
- : Current Playback Time.
- : Current Playback Mode : There are 4 modes. They can be selected in order by pressing the REPEAT button.
  - Off : Normal Playback
  - Track : Repeats the current track.
  - Folder : Repeats the current folder.
  - Random : Files in the disc will be played in random order.

• : MP3 file icon.

• : WMA file icon.

• : JPEG file icon.

• : Folder icon.

• : Current Folder icon.

## Folder Selection

The folder can only be selected in the Stop mode.

### • To select the Parent Folder

Press the RETURN button to go to parent folder, or use the UP/DOWN buttons to select "." and press ENTER to go to the parent folder.

### • To select the Peer Folder

Use the LEFT/RIGHT buttons to highlight left window. Use the UP/DOWN buttons to select the desired folder, then press ENTER.

### • To select the Sub-Folder

Use the LEFT/RIGHT buttons to highlight right window. Use the UP/DOWN buttons to select the desired folder, then press ENTER.

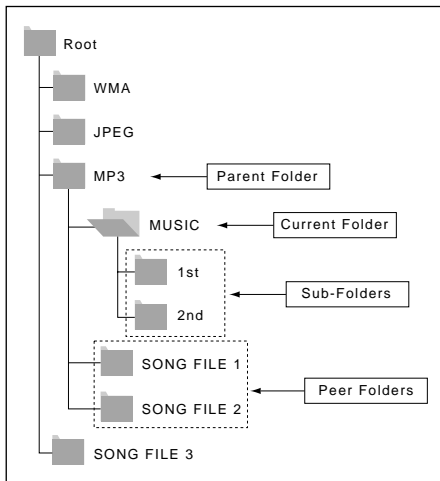

## MP3/WMA Playback

1. Open the disc tray.
2. Place the disc on the tray.
  - Place the disc with the labeled side up.
3. Close the tray.
  - The tray closes and you should get a screen that looks like the one below.

### MP3/WMA Play Function

1. Select the desired folder.
2. Use the UP/DOWN or LEFT/RIGHT buttons to select a song file.
3. Press ENTER to begin playback of the song file.



### Repeat/Random playback

Press the REPEAT button to change playback mode. There are 4 modes, Such as Off, Track, Folder and Random.

- Off : Normal Playback
- Track : Repeats the current song file.
- Folder : Repeats the song files which have the same extension in the current folder.
- Random : Song files which have the same extension will be played in random order.

\* To resume normal play, press the CLEAR button.

## MP3/WMA Playback

### CD-R MP3/WMA discs

When you record MP3 or WMA files on CD-R, please refer to the following.

#### • Your MP3 or WMA files should be ISO 9660 or JOLIET format.

ISO 9660 format and Joliet MP3 or WMA files are compatible with Microsoft's DOS and Windows, and with Apple's Mac. This format is the most widely used.

#### • When naming your MP3 or WMA files, do not exceed 8 characters, and enter ".mp3, .wma" as the file extension.

General name format of: Title.mp3. or Title.wma. When composing your title, make sure that you use 8 characters or less, have no spaces in the name, and avoid the use of special characters including: (.,\,=,+).

#### • Use a decompression transfer rate of at least 128 Kbps when recording MP3 files.

Sound quality with MP3 files basically depends on the rate of compression/decompression you choose. Getting CD audio sound requires an analog/digital sampling rate, that is conversion to MP3 format, of at least 128 Kbps and up to 160 Kbps. However, choosing higher rates, like 192 Kbps or more, only rarely give better sound quality. Conversely, files with decompression rates below 128 Kbps will not be played properly.

#### • Use a decompression transfer rate of at least 64Kbps when recording WMA files.

Sound quality with WMA files basically depends on the rate of compression/decompression you choose. Getting CD audio sound requires an analog/digital sampling rate, that is conversion to WMA format, of at least 64Kbps and up to 192Kbps. Conversely, files with decompression rates below 64Kbps or over 192Kbps will not be played properly.

#### • Do not try recording copyright protected MP3 files.

Certain "secured" files are encrypted and code protected to prevent illegal copying. These files are of the following types: Windows Media™ (registered trade mark of Microsoft Inc) and SDMI™ (registered trade mark of The SDMI Foundation). You cannot copy such files.

• **Important:** The above recommendations cannot be taken as a guarantee that the DVD player will play MP3 recordings, or as an assurance of sound quality. You should note that certain technologies and methods for MP3 file recording on CD-Rs prevent optimal playback of these files on your DVD player (degraded sound quality and in some cases, inability of the player to read the files).

• This unit can play a maximum of 3000 files and 300 folders per disc.

## Picture CD Playback

1. Select the desired folder. (See page 22 to select the folder)
2. Use the UP/DOWN buttons to select a Picture file in clips menu and then press the ENTER button. You should get a screen that looks like the one below.

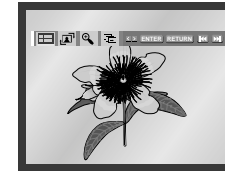

• Use the INFO button on the remote control to select the menu you want to view and then press the ENTER button.

• : Returns to the Album Screen.

• To see the next 6 pictures, press the button.

• To see the previous 6 pictures, press the button.

• : Each time the ENTER button is pressed, the picture rotates 90 degrees clockwise.

• : Each time the ENTER button is pressed, the picture is enlarged up to 4X. (Normal → 2X → 4X → 2X → Normal)

• : The unit enters slide show mode.

\*Before beginning the Slide Show, the picture interval must be set.

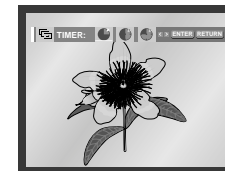

• : When this icon is selected and ENTER is pressed, the pictures change automatically with about 6 seconds interval.

• : The pictures change automatically with about 12 seconds interval.

• : The pictures change automatically with about 18 seconds interval.

\*Depending on a file size, the amount of time between each picture may be different from the manual.

\*If you don't press any button, the slide show will start automatically in about 10 seconds by default.

## Picture CD Playback

### Note

- If no buttons on the remote control pressed for 10 seconds, the menu will disappear. Press the INFO button on the remote control to display the menu again.
- Press the STOP button to return to the clips menu.
- When playing a Kodak Picture CD, the unit displays the Photo directly, not the clips menu.

### CD-R JPEG Discs

- Only files with the ".jpg" and ".JPG" extensions can be played.
- If the disc is not closed, it will take longer to start playing and not all of the recorded files may be played.
- Only CD-R discs with JPEG files in ISO 9660 or Joliet format can be played.
- The name of the JPEG file may not be longer than 8 characters and should contain no blank spaces or special characters (. / = +).
- Only a consecutively written multisession disc can be played. If there is a blank segment in the multisession disc, the disc can be played only up to the blank segment.
- A maximum of 3000 images can be stored on a single CD.
- Kodak Picture CDs are recommended.
- When playing a Kodak Picture CD, only the JPEG files in the pictures folder can be played.
- Kodak Picture CD : The JPEG files in the pictures folder can be played automatically.
- Konica Picture CD : If you want to see the Picture, select the JPEG files in the clips menu.
- Fuji Picture CD : If you want to see the Picture, select the JPEG files in the clips menu.
- QSS Picture CD : The unit cannot play QSS Picture CD.
- If the number of files in 1 Disc is over 3000, only 3000 JPEG files can be played.
- If the number of folders in 1 Disc is over 300, only JPEG files in 300 folders can be played.

## Beginning Karaoke Functions (DVD-P4545K Only)

### Operation Sequence

1. Connect the Mixed Audio Out terminals with the TV or AMP.
2. Connect Mic into Mic jack.
  - When the MIC should be connected, karaoke function can operate.

### Key Control

1. Press the KARAOKE button.
2. Select the "Keycon" using the LEFT/RIGHT buttons.
3. By use of the LEFT/RIGHT buttons, change to the desired tone.
  - ⌵: To let 7 scales down by half scale.
  - 1: Original scale.
  - ⌴: To let 7 scales up by half scale.

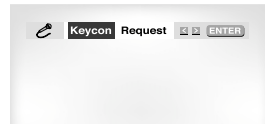

### Note

- If you hear strange noises(squealing or howling) while using the karaoke feature, move the microphone away from the speakers. Turning down the microphone volume or the speaker volume is also effective.
- When playing MP3, WMA and LPCM disc, karaoke functions are not operate.
- When the MIC is connected, Digital Out does not work.

## Reserving a Song (DVD-P4545K Only)

It is the function to reserve the desired song in advance by use of Karaoke function.

### Sequence of reservation

1. Playback the Karaoke Disc containing the wanted songs.
2. Press the KARAOKE button.
3. Select the "Request" using the LEFT/RIGHT buttons.

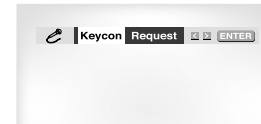

4. Input the number (Track No.) of the desired song into the flickering part(--).
  - You can reserve up to 10 songs.



5. When you want the next reserved song during playing a song, press the SKIP(▶▶) button.

### Cancellation of reservation

1. Press the KARAOKE button.
2. Select the "Request" using the LEFT/RIGHT buttons.
3. Cancel by pressing the CLEAR button of the remote.
  - The last reserved song will be erased first.
4. Continuous pressing of the CLEAR button can cancel the next reserved song.
5. If the reservation is required again, input the song number in the flickering part.

### Note

- When using "SKIP(▶▶)" button, it can not work at the last song.
- When using Request function, the "INFO" and "REPEAT" function does not work.

## Vocal Function (DVD-P4545K Only)

When pressing the KARAOKE button twice, this screen displays.

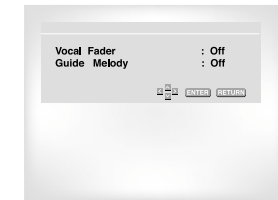

### Vocal Fader

- This function can provide the only melody without vocal sound when playing a Karaoke disc.

	VOCAL FADER	Remark
↓	V1	CH1. Vocal Cancel
↓	V2	CH2. Vocal Cancel
↓	V1 + V2	CH1, CH2. Vocal Cancel
↓	OFF	Vocal Fader Off

- In VCD, CVD or CD, you can select only the L, R or Off.

### Guide Melody

- To guide melody through xylophone and piano help you sing easily.

- This function works only on the DVD Karaoke disc on which the guide melody is recorded.

## Vocal Function (DVD-P4545K Only)

### Types of Karaoke disc

#### • DVD Karaoke Disc

Channel	Karaoke -Channel	5CH. DVD	2CH. DVD
1 CH	L	Left stereo music	Left stereo music + Vocal
2 CH	R	Right stereo music	Right stereo music + Vocal
3 CH	M	Guide melody	-
4 CH	V1	Vocal track	-
5 CH	V2	Vocal track	-

#### • CVD, VCD Karaoke Disc

Channel	Karaoke -Channel	CVD	VCD, CD
1 CH	CH1 LEFT	Left stereo music + Vocal	Left stereo music
1 CH	CH1 RIGHT	Right stereo music + Vocal	Right stereo music + Vocal
2 CH	CH2 LEFT	Left stereo music	-
2 CH	CH2 RIGHT	Right stereo music	-

## Using the Setup Menu

The Setup menu lets you customize your DVD player by allowing you to select various language preferences, set up a parental level, even adjust the player to the type of television screen you have.

1. With the unit in Stop mode, press the MENU button on the remote. Select **Setup** using UP/DOWN buttons, then press the RIGHT or ENTER button.

- ❶ **Language Setup** : Setup of the Language.
- ❷ **Audio Setup** : Setup of the Audio Options
- ❸ **Display Setup** : Setup of the Display Options  
Use to select which type of screen you want to watch and several display options.
- ❹ **Parental Setup** : Setup of the Parental Level  
Allows users to set the level necessary to prevent children from viewing unsuitable movies such as those with violence, adult subject matter, etc.



2. Use the UP/DOWN buttons on the remote to access the different features.
3. Press the ENTER or RIGHT button to access the sub features.

To make the setup screen disappear after setting up, press the MENU button again.

#### Note

Depending on the disc, some Setup Menu selections may not work.

## Setting Up the Language Features

If you set the player menu, disc menu, audio and subtitle language in advance, they will come up automatically every time you watch a movie.

### Using the Player Menu Language

1. With the unit in Stop mode, press the MENU button.
2. Select **Setup** using UP/DOWN buttons, then press the RIGHT or ENTER button.
3. Select **Language Setup** using UP/DOWN buttons, then press the RIGHT or ENTER button.

e.g) Setting up in English.



4. Select **Player Menu** using UP/DOWN buttons, then press the RIGHT or ENTER button.

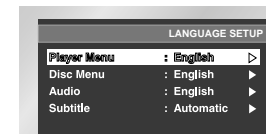

5. Use the UP/DOWN buttons to select 'English'.



6. Press the ENTER button.
  - English is selected and the screen returns to SETUP menu.
  - To make the Language Setup menu disappear, press the RETURN or LEFT button.

### Using the Disc Menu Language

This function changes the text language only on the disc menu screens.

1. With the unit in Stop mode, press the MENU button.
2. Select **Setup** using UP/DOWN buttons, then press the RIGHT or ENTER button.
3. Select **Language Setup** using UP/DOWN buttons, then press the RIGHT or ENTER button.
4. Select **Disc Menu** using UP/DOWN buttons, then press the RIGHT or ENTER button.
5. Use the UP/DOWN buttons to select 'English'.  
- Select "Others" if the language you want is not listed.

e.g) Setting up in English.



6. Press the ENTER button.
  - English is selected and the screen returns to Language Setup menu.

## Setting Up the Language Features

### Using the Audio Language

1. With the unit in Stop mode, press the MENU button.
2. Select **Setup** using UP/DOWN buttons, then press the RIGHT or ENTER button.
3. Select **Language Setup** using UP/DOWN buttons, then press the RIGHT or ENTER button.
4. Select **Audio** using UP/DOWN buttons, then press the RIGHT or ENTER button.
5. Press the UP/DOWN buttons to select '**English**'.
  - Select "Original" if you want the default soundtrack language to be the original language the disc is recorded in.
  - Select "Others" if the language you want is not listed.



6. Press the ENTER button.
  - English is selected and the screen returns to Language Setup menu.

### Using the Subtitle Language

1. With the unit in Stop mode, press the MENU button.
2. Select **Setup** using UP/DOWN buttons, then press the RIGHT or ENTER button.
3. Select **Language Setup** using UP/DOWN buttons, then press the RIGHT or ENTER button.
4. Select **Subtitle** using UP/DOWN buttons, then press the RIGHT or ENTER button.
5. Use the UP/DOWN buttons to select '**English**'.
  - Select "Automatic" if you want the subtitle language to be the same as the language selected as the audio preference.
  - Select "Others" if the language you want is not listed. Some discs may not contain the language you select as your initial language; in that case the disc will use its original language setting.



6. Press the ENTER button.
  - English is selected and the screen returns to Language Setup menu.

#### Note

- If the selected language is not recorded on the disc, the original pre-recorded language is selected.
- **How to make the SETUP menu disappear or return to menu screen during set up;** Press RETURN or LEFT button.

## Setting Up the Audio Options

1. With the unit in Stop mode, press the MENU button.
2. Select **Setup** using UP/DOWN buttons, then press the RIGHT or ENTER button.
3. Select **Audio Setup** using UP/DOWN buttons, then press the RIGHT or ENTER button.



4. Use the UP/DOWN buttons to select the desired item. Then press the RIGHT or ENTER button.

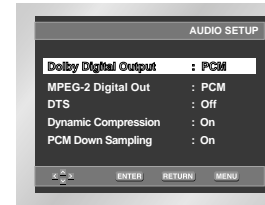

### 1 Dolby Digital Output

1. PCM : Converts to PCM(2CH) 48kHz audio. Select PCM when using the Analog Audio Outputs.
2. Bitstream : Converts to Dolby Digital Bitstream (5.1CH). Select Bitstream when using the Digital Audio Output.

- Note**
- Be sure to select the correct Digital Output or no audio will be heard.
  - When Multi Channel Output select Digital. Dolby & MPEG-2 Digital Out works.

### 2 MPEG-2 Digital Out

1. PCM : Converts to PCM(2CH) audio. Select PCM when using the Analog Audio Outputs.
2. Bitstream : Converts to MPEG-2 Digital Bitstream (5.1CH or 7.1CH). Select Bitstream when using the Digital Audio Output.

### 3 DTS

1. Off : Doesn't output digital signal.
2. On : Outputs DTS Bitstream via digital output only. Select DTS when connecting to a DTS Decoder.

- Note** There is no analog audio output when you play DTS sound disc.

### 4 Dynamic Compression

1. On : To select dynamic compression.
2. Off : To select the standard range.

### 5 PCM Down Sampling

1. On : Select this when the amplifier connected to the player is not 96KHz compatible. In this case, the 96KHz signals will be down converted to 48KHZ.
2. Off : Select this when the amplifier connected to the player is 96KHz compatible. In this case, all signals will be output without any changes.

#### Note

- **How to make the SETUP menu disappear or return to menu screen during set up;** Press RETURN or LEFT button.
- Manufactured under license from Dolby Laboratories. "Dolby" and the double-D symbol are trademarks of Dolby Laboratories.
- "DTS" and "DTS Digital Out" are trademarks of Digital Theater Systems, Inc.

## Setting Up the Display Options

1. With the unit in Stop mode, press the MENU button.
2. Select **Setup** using UP/DOWN buttons, then press the RIGHT or ENTER button.
3. Select **Display Setup** using UP/DOWN buttons, then press the RIGHT or ENTER button.



4. Use the UP/DOWN buttons to select the desired item. Then press the RIGHT or ENTER button.

### 1 TV Aspect

Depending on the type of television you have, you may want to adjust the screen setting (aspect ratio).

1. 4:3 Letter Box : Select when you want to see the total 16:9 ratio screen DVD supplies, even though you have a TV with a 4:3 ratio screen. Black bars will appear at the top and bottom of the screen.
2. 4:3 Pan Scan : Select this for conventional size TVs when you want to see the central portion of the 16:9 screen. (Extreme left and right side of movie picture will be cut off.)
3. 16:9 Wide : You can view the full 16:9 picture on your widescreen TV.

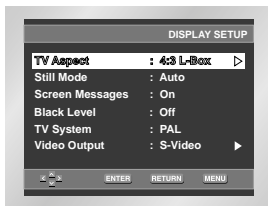

### 2 Still Mode

These options will help prevent picture shake in still mode and display small text clearer.

1. Auto : When selecting Auto, Field/Frame mode will be automatically converted.
2. Field : Select this feature when the screen shakes in the Auto mode.
3. Frame : Select this feature when you want to see small letters more clearly in the Auto mode.

### 3 Screen Messages

Use to turn on-screen messages On or Off.

### 4 Black Level

Adjusts the brightness of the screen.(On/Off)

### 5 TV System

1. NTSC Disc : In case of using NTSC disc
  - If your TV system only has PAL-Video input you must choose "PAL". When you choose "PAL", Interface output format is PAL 60 Hz output.
  - If your TV system only has NTSC, input you must choose "NTSC Output".
2. PAL Disc : In case of using PAL disc
  - If your TV system only has NTSC-Video input, you must choose "NTSC Output".
  - If your TV system only has PAL input, you must choose "PAL 50 Hz Output".

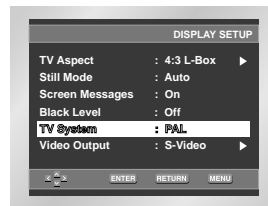

## Setting Up the Display Options

### 6 Video Output

Select Video Output.

1. S-Video : Select when you want to use Video and S-Video Out.
2. Component (I-SCAN) : Select when you want to use Video and Component (Interlace) Out
3. Component (P-SCAN) : Select when you want to use Component (Progressive) Out.

\* If there is no Yes/No selection for 10 seconds at Display in the sub Menu, Video system returns to the previous menu.



### Important Note

- Consult your TV User's Manual to find out if your TV supports Progressive Scan. If Progressive Scan is supported, follow the TV User's Manual's instructions regarding Progressive Scan settings in the TV's menu system.
- If the screen is blocked by setting the wrong Video Output, See page 33.

## Setting Up the Parental Control

The Parental Control function works in conjunction with DVDs that have been assigned a rating - which helps you control the types of DVDs that your family watches. There are up to 8 rating levels on a disc.

1. With the unit in Stop mode, press the MENU button.
2. Select **Setup** using UP/DOWN buttons, then press the RIGHT or ENTER button.
3. Select **Parental Setup** using UP/DOWN buttons, then press the RIGHT or ENTER button.



4. Use RIGHT or ENTER to select **Yes** if you want to use a password. The **Enter Password** screen appears.

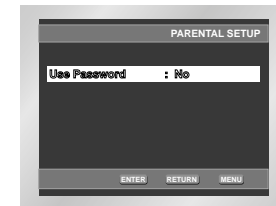

5. Enter your password. The **Re-enter Password** screen appears to confirm the password. Enter your password again. The player is locked ( ).

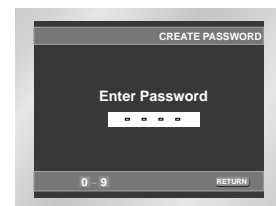



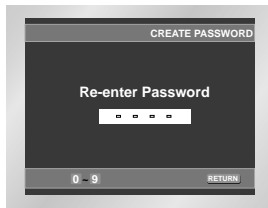

5. Select **Rating Level** using UP/DOWN buttons, and press ENTER or RIGHT button.

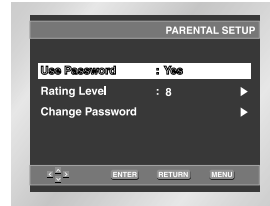

6. Select Rating Level you want using UP/DOWN buttons. For example, if you select up to Level 6, discs that contain Level 7, 8 will not play.  
- To cancel the Rating Level, select No using RIGHT or ENTER in Use Password.

e.g) Setting up in LEVEL6.

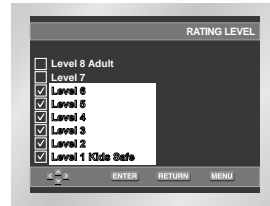

### About the Change Password;

- Highlight **Change Password** using UP/DOWN buttons.
- Press ENTER button.
- The **Change Password** screen appears.
- Enter your new password. Enter the new password again.

### Note

- **How to make the SETUP menu disappear or return to menu screen during set up;** Press RETURN or LEFT button.
- If you have forgotten your password, see Forgot Password in the Troubleshooting Guide.

### Setting Up the Rating Level

1. With the unit in Stop mode, press the MENU button.
2. Select **Setup** using UP/DOWN buttons, then press the RIGHT or ENTER button.  
The player is locked (🔒).



3. Select **Parental Setup** using UP/DOWN buttons, then press the RIGHT or ENTER button.
4. Enter your password.  
The Parental Setup screen appears.

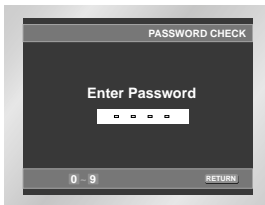

Before requesting service (troubleshooting), please check the following.

Problem	Action	Page
No operations can be performed with remote.	<ul style="list-style-type: none"> <li>• Check the batteries in the remote. They may need replacing.</li> <li>• Operate the remote control at a distance of no more than 20 feet.</li> <li>• Remove batteries and hold down one or more buttons for several minutes to drain the microprocessor inside the remote to reset it. Reinstall batteries and try to operate the remote again.</li> </ul>	P3
Disc does not play.	<ul style="list-style-type: none"> <li>• Ensure that the disc is installed with the label side facing up.</li> <li>• Check the region number of the DVD.</li> </ul>	P5
5.1 channel sound is not being reproduced.	<ul style="list-style-type: none"> <li>• 5.1 channel sound is reproduced only when the following conditions are met : 1) The DVD player is connected with the proper amplifier 2) The disc is recorded with 5.1 channel sound.</li> <li>• Check whether the disc being played has the "Dolby 5.1 ch" mark on the outside.</li> <li>• Check if your audio system is connected and working properly.</li> <li>• In a SETUP Menu, is the Audio Output set to Bitstream?</li> </ul>	P10 P29
The ⓪ icon appears on screen.	<ul style="list-style-type: none"> <li>• The features or action cannot be completed at this time because: 1. The DVD's software restricts it. 2. The DVD's software doesn't support the feature (e.g., angles). 3. The feature is not available at the moment. 4. You've requested a title or chapter number or search time that is out of range.</li> </ul>	P12
Disc Menu doesn't appear.	<ul style="list-style-type: none"> <li>• Check if the disc has a Menu.</li> </ul>	P26~32
Play mode differs from the Setup Menu selection.	<ul style="list-style-type: none"> <li>• Some of the functions selected in the Setup Menu may not work properly if the disc is not encoded with the corresponding function.</li> </ul>	P30~31
The screen ratio cannot be changed.	<ul style="list-style-type: none"> <li>• The Screen Ratio is fixed on your DVDs.</li> </ul>	P29
No audio.	<ul style="list-style-type: none"> <li>• Make sure you have selected the correct Digital Output in the Audio Options Menu.</li> </ul>	P31
The screen is blocked	<ul style="list-style-type: none"> <li>• Press power on from a cold start with no disc in the unit. Press the STOP (■) and PLAY (▶) buttons simultaneously on the front panel for three seconds. The SELECT MENU LANGUAGE display will appear. Select the number button of the desired language.</li> </ul>	P31~32
Forgot password	<ul style="list-style-type: none"> <li>• Press power on from a cold start with no disc in the unit. Press the STOP (■) and PLAY (▶) buttons simultaneously on the front panel for three seconds. The SELECT MENU LANGUAGE display will appear. Select the number button of the desired language. Press the MENU button, and then press DOWN button to select Setup, then press RIGHT or ENTER. Press UP or DOWN to Select Parental Setup. The Parental Setup is now unlocked as indicated on the display. You can change your password.</li> </ul>	P31~32
If you experience other problems.	<ul style="list-style-type: none"> <li>• Go to the contents and find the section of the instruction book that contains the explanations regarding the current problem, and follow the procedure once again.</li> <li>• If the problem still cannot be solved, please contact your nearest authorized service center.</li> </ul>	

## Specifications

General	Power Requirements	AC 110~240 V, 50/60 Hz
	Power Consumption	12 W
	Weight	1.8 Kg
	Dimensions	430mm (W) X 207mm (D) X 46mm (H)
	Operating Temperature Range	+5°C to +35°C
	Operating Humidity Range	10 % to 75 %
Disc	DVD (DIGITAL VERSATILE DISC)	Reading Speed : 3.49 ~ 4.06 m/sec. Approx. Play Time (Single Sided, Single Layer Disc) : 135 min.
	CD : 12Cm (COMPACT DISC)	Reading Speed : 4.8 ~ 5.6 m/sec. Maximum Play Time : 74 min.
	CD : 8Cm (COMPACT DISC)	Reading Speed : 4.8 ~ 5.6 m/sec. Maximum Play Time : 20 min.
	VCD : 12Cm	Reading Speed : 4.8 ~ 5.6 m/sec. Maximum Play Time : 74 min. (Video + Audio)
Video Output	Composite Video	1 channel : 1.0 Vp-p (75 Ω load)
	Component Video	Y : 1.0 Vp-p (75 Ω load) Pr : 0.70 Vp-p (75 Ω load) Pb : 0.70 Vp-p (75 Ω load)
	S-Video	Luminance Signal : 1.0 Vp-p (75 Ω load) Chrominance Signal : 0.3 Vp-p (75 Ω load)
Audio Output	2 channel	L(1/L), R(2/R)
	*Frequency Response	48 kHz Sampling : 4 Hz to 22 kHz 96 kHz Sampling : 4 Hz to 44 kHz
	*S/N Ratio	110 dB (DVD-P4444) 105dB (Karaoke off Mode DVD-P4545K)
	*Dynamic Range	100 dB (DVD-P4444) 96 dB (Karaoke off Mode DVD-P4545K)
	*Total Harmonic Distortion	0.004 % (DVD-P4444) 0.004 % (Karaoke off Mode DVD-P4545K)

\*: Nominal specification

- Samsung Electronics Co., Ltd reserves the right to change the specifications without notice.
- Weight and dimensions are approximate.