

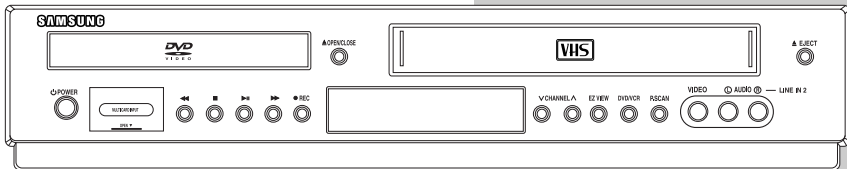



Instruction Manual

DVD-V8500



Safety Instructions

| | | |
|---|---|---|
| <p>CAUTION</p> <p>RISK OF ELECTRIC SHOCK DO NOT OPEN</p> <p>CAUTION: TO REDUCE THE RISK OF ELECTRIC SHOCK, DO NOT REMOVE COVER (OR BACK). NO USER SERVICEABLE PARTS INSIDE. REFER SERVICING TO QUALIFIED SERVICE PERSONNEL.</p> |  | <p>This symbol is intended to alert the user to the presence of uninsulated “dangerous voltage” within the product’s enclosure that may be of sufficient magnitude to constitute a risk of fire or electric shock to persons.</p> |
| |  | <p>This symbol is intended to alert the user to the presence of important operating and maintenance (servicing) instructions in the literature accompanying the appliance.</p> |

Note to CATV system installer: This reminder is provided to call CATV system installer’s attention to Article 820-40 of the National Electrical Code (Section 54 of Canadian Electrical Code, Part I) that provides guidelines for proper grounding and, in particular, specifies that the cable ground shall be connected to the grounding system of the building as close to the point of cable entry as practical.

Caution: FCC regulations state that any unauthorized changes or modifications to this equipment may void the user’s authority to operate it.

Caution: To prevent electric shock, match wide blade of plug to wide slot, fully insert.

Attention: Pour éviter les chocs électriques, introduire la lame le plus large de la fiche dans la borne correspondante de la prise et pousser jusqu’au fond.

Important: One Federal Court has held that unauthorized recording of copyrighted TV programs is an infringement of U.S. copyright laws. Certain Canadian programs may be copyrighted and any unauthorized recording in whole or in part may be a violation of these rights.

**To prevent damage which may result in fire or electric shock hazard,
do not expose this appliance to rain or moisture.**

Important Safety Instructions

1. Read these instructions.
2. Keep these instructions.
3. Heed all warnings.
4. Follow all instructions.
5. Do not use this apparatus near water.
6. Clean only with dry cloth.
7. Do not block any ventilation openings. Install in accordance with the manufacturer’s instructions.
8. Do not install near any heat sources such as radiators, heat registers, stoves, or other apparatus (including amplifiers) that produce heat.
9. Do not defeat the safety purpose of the polarized or grounding-type plug. A polarized plug has two blades with one wider than the other. A grounding type plug has two blades and a third grounding prong. The wide blade or the third prong is provided for your safety. If the provided plug does not fit into your outlet, consult an electrician for replacement of the obsolete outlet.
10. Protect the power cord from being walked on or pinched particularly at plugs, convenience receptacles, and the point where they exit from the apparatus.
11. Only use attachments/accessories specified by the manufacturer.
12. Use only with cart, stand, tripod, bracket, or table specified by the manufacturer, or sold with the apparatus. When a cart is used, use caution when moving the cart/apparatus combination to avoid injury from tip-over.
13. Unplug this apparatus during lightning storms or when unused for long periods of time.
14. Refer all servicing to qualified service personnel. Servicing is required when the apparatus has been damaged in any way, such as power-supply cord or plug is damaged, liquid has been spilled or objects have fallen into the apparatus, the apparatus has been exposed to rain or moisture, does not operate normally, or has been dropped.

Before you start

Accessories



Remote Control
(AK59-00008X)



Batteries-2EA
1.5V(AAA)
(AC43-12002H)



Video/Audio Cable
(AC97-01746A)



Antenna Cable
(AC39-42001J)

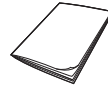

User's Guide

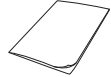

Registration Card

Install Batteries in the Remote Control

1

Open the battery cover on the back of the remote control.

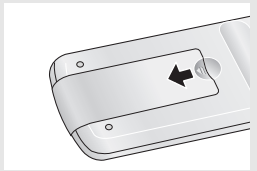

2

Insert two AAA batteries. Make sure that the polarities (+ and -) are aligned correctly.

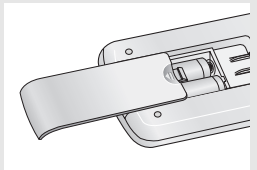

3

Replace the battery cover.

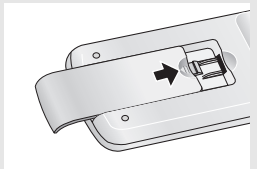

If the remote control doesn't operate properly:

- Check the polarity +, - of the batteries (Dry-Cell)
- Check if the batteries are drained.
- Check if remote control sensor is blocked by obstacles.
- Check if there is any fluorescent lighting nearby.

Table of Contents

| | |
|---|---|
| Safety Instructions | 2 |
| Important Safety Instructions | 2 |
| Before you start | 3 |
| Accessories..... | 3 |
| Install Batteries in the Remote Control | 3 |

Chapter 1: Setup

| | |
|-------------------------------------|----|
| General Features..... | 6 |
| Disc Type and Characteristics | 7 |
| Description..... | 8 |
| Tour of the Remote Control..... | 10 |

Chapter 2: Connections

| | |
|--|----|
| Connecting the Antenna Cable | 11 |
| Method1: Antenna + DVD-VCR + TV: No Cable box | 11 |
| Method2: Antenna + DVD-VCR + TV: Cable box with many scrambled channels | 12 |
| Method3: Antenna + DVD-VCR + TV: Cable box with a few scrambled channels | 12 |
| Before Connecting the DVD-VCR | 13 |
| Connection to a TV | 13 |
| Connection to a TV (Video)..... | 13 |
| Connection to a TV (S-Video) | 14 |
| Connection to a TV (Interlace) | 15 |
| Connection to a TV (Progressive)..... | 16 |
| Connection to an Audio System | 17 |
| Connection to an Audio System (2 Channel Amplifier) | 17 |
| Connection to an Audio System (Dolby digital, MPEG2 or DTS Amplifier) | 18 |
| Connecting a Power Cord & Auto Setup | 19 |

Chapter 3: Initial Setup

| | |
|---|----|
| Selecting a Menu Language | 20 |
| Setting the Clock | 21 |
| Setting the Clock Automatically..... | 21 |
| Setting the Clock Manually | 23 |
| Memorizing the Channel | 24 |
| Selecting the Video Signal-source | 24 |
| Storing Channels in Memory (Automatic Method) | 25 |
| Adding and Erasing Channels (Manual Method) | 25 |
| Selecting the RF Output Channel | 26 |
| Setting the Front Panel Display | 27 |
| Setting the Power Off Automatically | 28 |

Chapter 4: DVD Operations

| | |
|----------------------|----|
| Playing a Disc | 29 |
|----------------------|----|

TABLE OF CONTENTS

| | |
|--|----|
| Using the Search and Skip Functions | 31 |
| Using the Display Function | 32 |
| Using the Disc and Title Menu (DVD) | 34 |
| Using the Function Menu (DVD) | 35 |
| Repeat Play | 36 |
| Slow Repeat Play | 38 |
| Adjusting the Aspect Ratio (EZ View) | 39 |
| Selecting the Audio Language | 41 |
| Selecting the Subtitle Language | 42 |
| Changing the Camera Angle | 43 |
| Using the Bookmark Function | 43 |
| Using the Zoom Function (DVD) | 45 |
| How to insert a Memory Card | 46 |
| Clips Menu for MP3/WMA/JPEG | 47 |
| Folder Selection | 47 |
| MP3/WMA Playback | 48 |
| Program Play & Random Play..... | 50 |
| Picture CD Playback | 51 |
| Using the Setup Menu | 53 |
| Setting Up the Language Features | 54 |
| Setting Up the Audio Options | 56 |
| Setting Up the Display Options | 58 |
| Setting Up the Parental Control | 60 |

Chapter 5: VCR Operations

| | |
|--|----|
| Inserting and Ejecting a Video Cassette Tape | 63 |
| Playing a Pre-Recorded Video Cassette Tape | 64 |
| Special VCR Playback Features | 65 |
| Using Automatic Tracking | 66 |
| Selecting the Cassette Type | 67 |
| Setting the Auto Play | 68 |
| Setting the Auto Repeat | 69 |
| Using the Tape Counter | 70 |
| Using the Assemble Edit Function | 71 |
| Selecting the Audio Output Mode | 72 |
| Searching for a Specific Sequence | 73 |
| Basic Recording | 75 |
| Special Recording Features | 76 |
| Using One-Touch Recording | 77 |
| Selecting the Recording Speed | 78 |
| Using a Timer Recording | 79 |

Chapter 6: Reference

| | |
|--|----|
| Using the TV Buttons on the Remote Control | 81 |
| Troubleshooting | 82 |
| Technical Specifications | 84 |

Chapter 1

SETUP

General Features

DVD-VCR Features

- Perfect compatibility to play back DVDs, audio CDs or VHS Tapes.
- Enjoy a DVD movie while recording a TV show to the VCR.
- Auto Setup instantly finds the time and runs channel search.
- RF inputs and outputs for all kinds of TVs available.
- Composite, S-Video, and Component Video outputs.
- Remote control provides full operation on DVD-VCR.
- On-Screen Program (English/French/Spanish).

DVD Features

- 10-bit video digital to analog converter and 54MHz advanced digital filter.
- Playback of 96KHz/24-bit sources.
- DTS digital output for DTS-enhanced DVDs.
- 2 slots to support 10 types of memory cards: MMC, SD, Smart Media Card, Compact Flash, Micro Drive, Memory Stick, Memory Stick-Pro, Memory Stick Duo, Mini SD Card and XD-Picture Card.
- Play back MP3-CDs.

VCR Features

- Hi-Fi Stereo VCR.
- Superior slow motion and stop action (with 4 heads).
- Playback of S-VHS tapes with a better than standard resolution.
- INTRO Scan, Zero Return, and END Search.
- 7-event/1 month timer recording.
- Time remaining counter, real time counter.

Note

- Discs which cannot be played with this player.
 - DVD-ROM/DVD-RAM/VCD
 - CDI/CDV
 - Super Audio CD (CD, HD layer)
 - CDGs play audio only, not graphics.
 - DVD-RW (VR mode)
 - Non-finalizing DVD-RW, -R, DVD+RW, and +R disc.

- Ability to play back may depend on recording conditions.
 - DVD-RW, -R/CD-RW/DVD+RW, +R/CD-ROM

Note

This product incorporates copyright protection technology that is protected by U.S. patents and other intellectual property rights. Use of this copyright protection technology must be authorized by Macrovision, and is intended for home and other limited viewing uses only unless otherwise authorized by Macrovision. Reverse engineering or disassembly is prohibited.

COPY PROTECTION

Many DVD discs are encoded with copy protection. Because of this, you should only connect your DVD-VCR directly to your TV, not to a VCR. Connecting to a VCR results in a distorted picture from copy-protected DVD discs.



This product incorporates copyright protection technology that is protected by methods claims of certain U.S. patents and other intellectual property rights owned by Macrovision Corporation and other rights owners. Use of this copyright protection technology must be authorized by Macrovision Corporation, and is intended for home and other limited viewing uses only unless otherwise authorized by Macrovision Corporation. Reverse engineering or disassembly is prohibited.

PROGRESSIVE SCAN OUTPUTS (525p)

“CONSUMERS SHOULD NOTE THAT NOT ALL HIGH DEFINITION TELEVISION SETS ARE FULLY COMPATIBLE WITH THIS PRODUCT AND MAY CAUSE ARTIFACTS TO BE DISPLAYED IN THE PICTURE, IF 525 PROGRESSIVE SCAN PICTURE PROBLEMS OCCUR, IT IS RECOMMENDED THAT THE USER SWITCH THE CONNECTION TO THE ‘STANDARD DEFINITION’ OUTPUT. IF THERE ARE QUESTIONS REGARDING YOUR TV SET COMPATIBILITY WITH THIS MODEL 525p DVD-VCR, PLEASE CONTACT SAMSUNG’S CUSTOMER SERVICE CENTER.”

Disc Type and Characteristics

This DVD-VCR is capable of playing the following types of discs with the corresponding logos:

| Disc Types (Logos) | Recording Types | Disc Size | Max. Playing Time | Characteristics |
|--|---------------------|-----------|--|---|
| DVD  | Audio + Video | 5" | Single-sided 240 min. Double-sided 480 min. | <ul style="list-style-type: none"> - DVD contains excellent sound and video due to Dolby Digital and MPEG-2 system. - Various screen and audio functions can be easily selected through the on-screen menu. |
| | | 3 1/2" | Single-sided 80 min. Double-sided 160 min. | |
| AUDIO-CD  | Audio | 5" | 74 min. | <ul style="list-style-type: none"> - CD is recorded as a Digital Signal with better audio quality, less distortion and less deterioration of audio quality over time. |
| | | 3 1/2" | 20 min. | |

- CD-R, CD-RW and DVD-RW, -R, DVD+RW, +R discs may not be playable in all cases due to the disc type or condition of the recording.

Disc Markings

| | |
|--|--|
|  | Play Region Number |
|  | NTSC broadcast system in U.S.A, Canada, Korea, Japan, etc. |
|  | Dolby Digital disc |
|  | Stereo disc |
|  | Digital Audio disc |
|  | DTS disc |
|  | MP3 disc |

Region Number

Both the DVD-VCR and the discs are coded by region. These regional codes must match in order for the disc to play. If the codes do not match, the disc will not play.

The Region Number for this player is described on the rear panel of the player. North America is Region 1.



You must only insert one DVD disc at a time. Inserting two or more discs will not allow playback and may cause damage to the DVD-VCR.

Description

Front Panel Controls

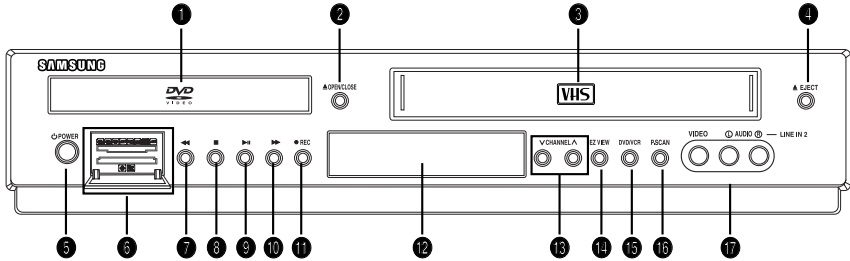

- | | |
|--|--|
| <p>1 DISC TRAY Place the disc here.</p> <p>2 OPEN/CLOSE Press to open and close the disc tray.</p> <p>3 VCR Deck Insert a standard VHS video tape.</p> <p>4 EJECT Press to eject a video tape if the tape is stopped.</p> <p>5 POWER Press to turn the DVD-VCR on and off.</p> <p>6 MULTI CARD INPUT Insert a Memory Card</p> <p>7 ◀◀ (Reverse/Rewind) Press to reverse/rewind a disc/video tape.</p> <p>8 ■ (STOP) Press to stop a disc/video tape during playback or record (VCR).</p> <p>9 ▶▶ (Play/Pause) Press to play or pause the disc/video tape.</p> | <p>10 ▶▶ (Forward/Fast Forward) Press to forward/fast forward a disc/videotape.</p> <p>11 REC (VCR) Press to begin recording.</p> <p>12 Front Panel Display Operation indicators are displayed here.</p> <p>13 CHANNEL ▾ and ▲ Press to change channels.</p> <p>14 EZ VIEW The aspect ratio of a picture can easily be adjusted to your TV's screen size.</p> <p>15 DVD/VCR Press to view DVD or VCR mode.</p> <p>16 P.SCAN Press to select component video out progressive scan mode.</p> <p>17 LINE IN 2 Connect to the Video/Audio output jack of your external device.</p> |
|--|--|

Front Panel Display

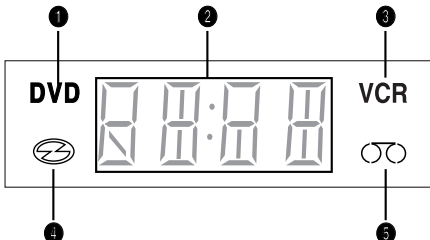

- 1 DVD is activated.
- 2 The time, counter position, time remaining or current deck status is indicated.
- 3 VCR is activated.
- 4 DVD or CD media is loaded.
- 5 VHS videotape is loaded.

Rear Panel

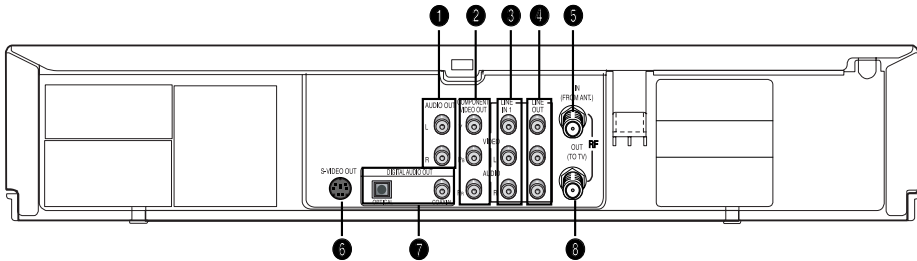

- | | |
|---|---|
| <p>1 AUDIO OUT Connect to the Audio input jacks of your television.</p> <p>2 COMPONENT VIDEO OUT - Use these jacks if you have a TV with Component Video in jacks. These jacks provide P_R, P_B and Y video. - If Component (Progressive Scan) Video Output is selected in the Alt Video Out menu or by using the P.SCAN button on the front panel, progressive scan mode will be enabled. - If Component (Interlace Scan) Video Output is selected in the Alt Video Out menu or by using the P.SCAN button on the front panel, interlaced scan mode will be enabled.</p> <p>3 LINE IN 1 (VIDEO/AUDIO) Connect to the Video/Audio output jack of your external device.</p> <p>4 LINE OUT (VIDEO/AUDIO) Use a Video/Audio cables to connect to the Video/Audio input jacks on your television.</p> | <p>5 RF IN (FROM ANT.) Connect the RF Antenna cable to your DVD-VCR</p> <p>6 S-VIDEO OUT Use the S-Video cable to connect this jack to the S-Video input jack on your television for higher picture quality.</p> <p>7 DIGITAL AUDIO OUT (OPTICAL/COAXIAL) - Use either an optical or coaxial digital audio cable to connect to a compatible Dolby Digital receiver. - Use either an optical or coaxial digital audio cable to connect to an A/V Amplifier that contains a Dolby Digital, MPEG2 or DTS decoder.</p> <p>8 RF OUT (TO TV) Connect your DVD-VCR to a TV</p> |
|---|---|

Notes

- Consult your TV User's Manual to find out if your TV supports Progressive Scan. If Progressive Scan is supported, follow the TV User's Manual regarding Progressive Scan settings in the TV's menu system.
- If Component (Progressive Scan) Output is selected in Alt Video Out menu, S-Video will not work.
- See pages 58 ~ 59 to get more information on how to use the Alt Video Out menu.

Tour of the Remote Control

- 1 **POWER button**
Turns the DVD-VCR's power on and off.
- 2 **NUMBER buttons**
- 3 **100+ button**
- 4 **DVD button**
Use to operate DVD.
- 5 **VCR button**
Use to operate VCR.
- 6 **DVD/M.CARD button**
Use to select DVD or M.CARD mode.
- 7 **VOL (+, -) buttons**
- 8 **Playback-related buttons**
Search/Skip/Stop/Play/Pause
- 9 **SUBTITLE button**
Use to display the DVD's subtitle language.
- 10 **MENU button**
Brings up the DVD-VCR player's menu.
- 11 **ENTER/▲▼◀▶ buttons**
This button functions as a toggle switch.
- 12 **REC button**
Use to begin recording. (VCR)
- 13 **CLEAR button**
Use to remove menus or status displays from the screen.
- 14 **EZVIEW/SPEED button**
The aspect ratio of a picture can easily be adjusted according to the screen size of your TV (16:9 or 4:3).

Use to select the tape recording speed. (VCR)
- 15 **MODE button**
Use to select the program or random play.

REPEAT button
Allows you to repeat play a title, chapter, track, or disc. (DVD)

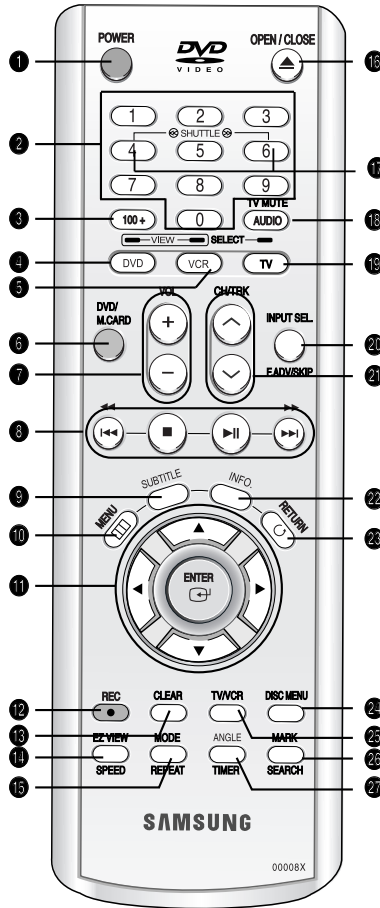

- 16 **OPEN/CLOSE button**
- 17 **SHUTTLE (↺/↻) buttons**
Use to play a sequence at variable speeds. (VCR)
- 18 **AUDIO/TV MUTE button**
Use this to access various audio functions on a disc. (DVD mode)
This operates as Sound Mute. (TV mode)
- 19 **TV button**
Use to operate TV.
- 20 **F.ADV/SKIP/INPUT SEL. button**
Use to advance play one frame at a time. (DVD and VCR)
Use to fast forward a video tape. (VCR)
Use to select a external signal source.
- 21 **CH/TRK button**
Use to change channels. (TV)
Use to adjust tape tracking. (VCR)
- 22 **INFO. button**
Displays the current disc mode. (DVD)
- 23 **RETURN button**
Returns to a previous menu.
- 24 **DISC MENU button**
Brings up the Disc menu. (DVD)
- 25 **TV/VCR button**
Use to switch between TV and VCR mode.
- 26 **MARK/SEARCH button**
Use to memorize scenes for replay. (DVD)
Displays the VCR Function menu. (VCR)
- 27 **ANGLE/TIMER button**
Use to access various camera angles on a disc. (DVD)
Displays the Manual Clock menu.

Chapter 2

CONNECTIONS

Connecting the Antenna Cable

There are several ways to connect your DVD-VCR. Select one of the following antenna connections that best suits you below.

- Method 1: Antenna + DVD-VCR + TV: No Cable box
- Method 2: Antenna +Cable box + DVD-VCR + TV: Cable box with many scrambled channels
- Method 3: Antenna + DVD-VCR + Cable box +TV: Cable box with a few scrambled channels

- If you are using an off-air antenna that has 300-ohm twin flat leads, use an external antenna connector (300-75 ohm adaptor: not supplied) to connect the antenna to the DVD-VCR.
- If you have two separate antennas (one VHF and the other UHF), use a UHF/VHF combiner-adaptor (available at most electronics shops) to connect the antenna to the DVD-VCR.
- The RF OUT(TO TV) jack of this product sends signals received through the antenna and outputs Audio/Video signals.

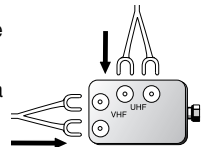
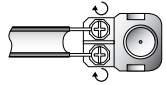

Method1: Antenna + DVD-VCR + TV: No Cable box

You can record non-scrambled channels by selecting the channel on the DVD-VCR. Also use this Method if you watch channels without cable box.

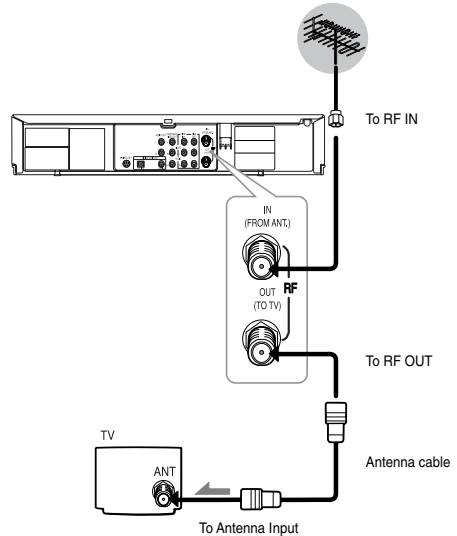

Before Connecting the DVD-VCR

- Always turn off the DVD-VCR, TV, and other components before you connect or disconnect any cables.
- Refer to the user's manual of the additional components (such as a TV) you are connecting for more information on those particular components.

Connection to a TV

The following shows examples of connections commonly used to connect the DVD-VCR with a TV and other components.

Connection to a TV (Video)

1

Using video/audio cables, connect the **VIDEO (yellow)/AUDIO (red and white) OUT** terminals on the rear of the DVD-VCR to the **VIDEO (yellow)/AUDIO (red and white) IN** terminals of your TV.

2

Turn on the DVD-VCR and TV.

3

Press the input selector on your TV remote control until the Video signal from the DVD-VCR appears on the TV screen.

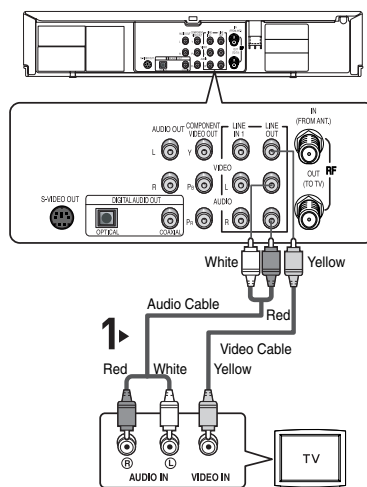

Notes

- **Noise may be generated if the audio cable is placed too close to the power cable.**
- If you want to connect to an Amplifier, please refer to the Amplifier connection page. (See pages 17 to 18)
- The number and position of terminals may vary depending on your TV set. Please refer to the user's manual of your TV.
- If there is one audio input terminal on the TV, connect it to the AUDIO OUT Left (white) terminal of the DVD-VCR.
- If you press the P.SCAN button when DVD-VCR is in stop mode or no disc is inserted, the Alt Video Out mode changes in the following sequence: (S-Video - Interlace - Progressive)
- When the Alt Video Output in Display Setup menu is set to Progressive, the S-Video Output does not work.

Connection to a TV (S-Video)

- Connecting to your TV using an S-Video cable.
- You will enjoy high quality images. S-Video separates the picture element into black and white(Y) and color(C) signals to present clearer images than regular video input mode. (Audio signals are delivered through the audio output.)

1

Using an S-Video cable (not included), connect the **S-VIDEO OUT** terminal on the rear of the DVD-VCR to the **S-VIDEO IN** terminal of your TV.

2

Using the audio cables, connect the **AUDIO (red and white) OUT** terminals on the rear of the DVD-VCR to the **AUDIO (red and white) IN** terminals of your TV.

Turn on the DVD-VCR and TV.

3

With the unit in stop mode, set the Alt video output to **S-Video** in the Display Setup menu (see pages 58~59) or press the **P.SCAN** button on the front panel until S-Video is output.

4

Press the input selector on your TV remote control until the S-Video signal from the DVD-VCR appears on your TV screen.

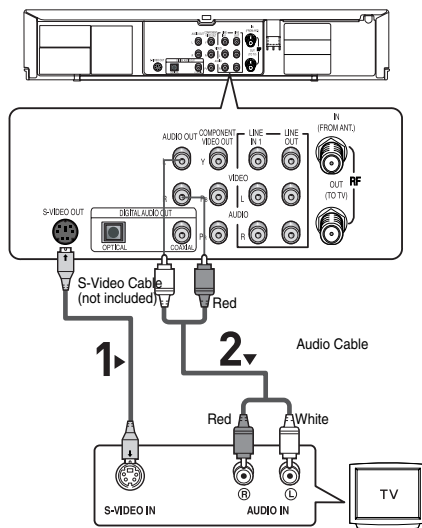

Notes

- If you want to connect to an Amplifier, please refer to the Amplifier connection page. (See pages 17 to 18)
- The number and position of terminals may vary depending on the TV set. Please refer to the user's manual of your TV.

Connection to a TV (Interlace)

- Connecting to your TV using Component video cables.
- You will enjoy high quality and accurate color reproduction images. Component video separates the picture element into black and white(Y), blue(P_B), red(P_R) signals to present clear and clean images. (Audio signals are delivered through the audio output.)

1

Using component video cables (not included), connect the **COMPONENT VIDEO OUT** terminal on the rear of the DVD-VCR to the **COMPONENT IN** terminal of your TV.

2

Using the audio cables, connect the **AUDIO (red and white) OUT** terminals on the rear of the DVD-VCR to the **AUDIO (red and white) IN** terminals of your TV.

Turn on the DVD-VCR and TV.

3

With the unit in stop mode, set the Alt video output to **Component: Interlace** in the Display Setup menu (see pages 58~59) or press the **P.SCAN** button on the front panel until Interlace is output.

4

Press the input selector on your TV remote control until the Component signal from the DVD-VCR appears on the TV screen.

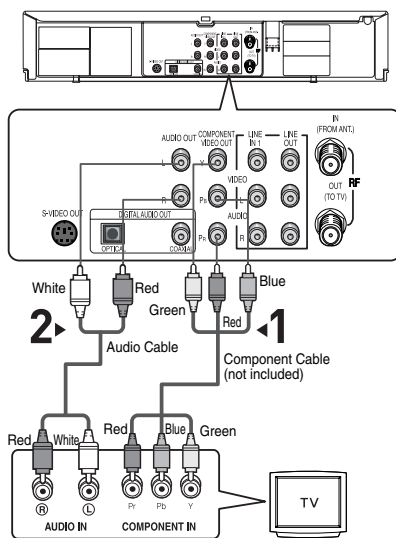

Notes

- If Video output is incorrectly set to S-Video with the Component cables connected, the screen will turn red.
- If you want to connect to an Amplifier, please refer to the Amplifier connection page. (See pages 17 to 18)
- The component terminal of your TV may be marked "R-Y, B-Y, Y" or "Cr, Cb, Y" instead of "P_R, P_B, Y" depending on the manufacturer. The number and position of terminals may vary depending on the TV set. Please refer to the user's manual of your TV.

Connection to a TV (Progressive)

1

Using component video cables (not included), connect the **COMPONENT VIDEO OUT** terminal on the rear of the DVD-VCR to the **COMPONENT IN** terminal of your TV.

2

Using the audio cables, connect the **AUDIO (red and white) OUT** terminals on the rear of the DVD-VCR to the **AUDIO (red and white) IN** terminals of your TV.

Turn on the DVD-VCR and TV.

3

With the unit in stop mode, set the Alt video output to **Component: Progressive** in the Display Setup menu (see pages 58–59) or press the **P.SCAN** button on the front panel until the Progressive Scan mode prompt screen appears.

Then press **ENTER** and progressive will be output.

4

Press the input selector on your TV remote control until the **Component signal** from the DVD-VCR appears on the TV screen.

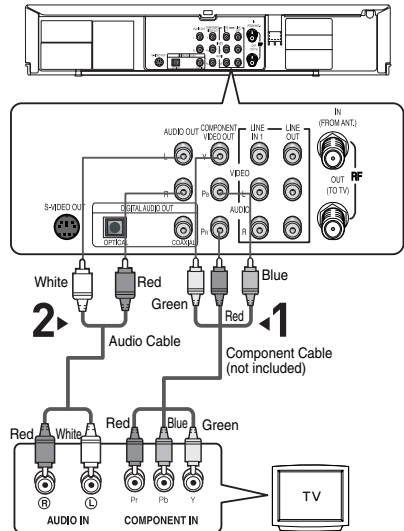

To see the progressive video output,

- Consult your TV User's Manual to find out if your TV supports Progressive Scan. If Progressive Scan is supported, follow the TV User's Manual regarding Progressive Scan settings in the TV's menu system.
- Depending on your TV, the connection method may differ from the illustration above.

Note

What is "Progressive Scan"?

Progressive scan has twice as many scanning lines as the interlace output method.

Progressive scanning method provides better and clearer picture quality.

Progressive scan only works in DVD mode, not VCR.

Connection to an Audio System

Connection to an Audio System (2 Channel Amplifier)

1

Using the audio cables, connect the (LINE) **AUDIO (red and white) OUT** terminals on the rear of the DVD-VCR to the **AUDIO (red and white) IN** terminals of the Amplifier.

2

Using the video signal cable(s), connect the **VIDEO, S-VIDEO** or **COMPONENT OUT** terminals on the rear of the DVD-VCR to the **VIDEO, S-VIDEO** or **COMPONENT IN** terminal of your TV as described on pages 14 to 16.

3

Turn on the DVD-VCR, TV, and Amplifier.

4

Press the input select button of the Amplifier to select external input in order to hear sound from the DVD-VCR.

Refer to your Amplifier's user manual to set the Amplifier's audio input.

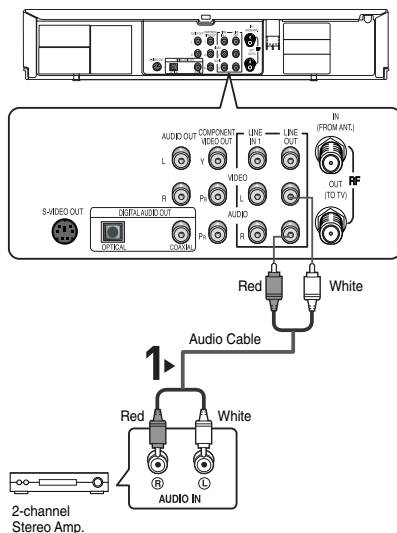

Notes

- Please turn the volume down when you turn on the Amplifier. Sudden loud sound may cause damage to the speakers and your ears.
- Please set the audio in the menu screen according to the Amplifier. (See pages 56 to 57)
- The position of terminals may vary depending on the Amplifier. Please refer to your Amplifier's user manual .

Connection to an Audio System (Dolby digital, MPEG2 or DTS Amplifier)

1

Using a coaxial cable (not included), connect the **DIGITAL AUDIO OUT (COAXIAL)** or **DIGITAL AUDIO OUT (OPTICAL)** terminal on the rear of the DVD-VCR to the **DIGITAL AUDIO IN (COAXIAL)** or **DIGITAL AUDIO OUT (OPTICAL)** terminal of the Amplifier.

2

Using the video signal cable(s), connect the **VIDEO**, **S-VIDEO** or **COMPONENT OUT** terminals on the rear of the DVD-VCR to the **VIDEO**, **S-VIDEO** or **COMPONENT IN** terminal of your TV as described on pages 14 to 16.

3

Turn on the DVD-VCR, TV, and Amplifier.

4

Press the input select button of the Amplifier to select external input in order to hear sound from the DVD-VCR.

Refer to your Amplifier's user manual to set the Amplifier's audio input.

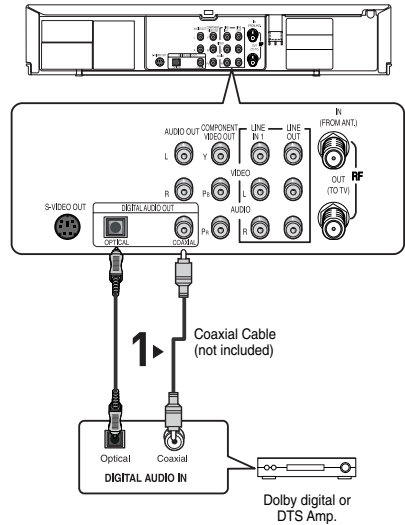

Notes

- When you connect the DVD-VCR to DTS Amplifier and play a DTS disc, set the DTS to On in Audio Setup menu. If it is set to Off, sound will not be heard, or there will be a loud sound.
- Please turn the volume down when you turn on the Amplifier. Sudden loud sound may cause damage to the speakers and your ears.
- Please set the audio in the menu screen according to the Amplifier. (See pages 56 to 57)
- The position of terminals may vary depending on the Amplifier. Please refer to the user's manual of the Amplifier.
- Only audio from the DVD player can be heard when connection is made via the Optical or Coaxial jack. You must have the analog L and R Audio Out connected to hear VCR audio (see page 17).

Connecting a Power Cord & Auto Setup

1

Your DVD-VCR's power cord should be plugged into a standard 120V/60Hz wall outlet. Avoid pressing any buttons on the remote control or on the unit during Auto Setup. While your DVD-VCR is running Auto Setup, "Auto" will blink. When Auto Setup is complete, the current time will be displayed on the front panel. If Auto Setup fails to locate a channel to set the clock, you should set the clock manually. (See page 22 to 23.)

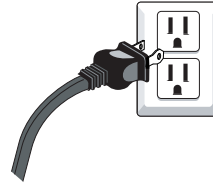

You must have the antenna connected to set the Auto Clock (See pages 11~12)

2

Turn on the power by pressing the **POWER** button on the remote control or on the front panel.

3

Turn on your TV by pressing the **POWER** button on the TV remote control.

Chapter 3

INITIAL SETUP

Selecting a Menu Language

To change the on-screen MENU language to English, French or Spanish, follow these steps.

1

Press the **MENU** button.



2

Press the **▲/▼** buttons to select **Setup**, then press the **▶** or **ENTER** button.



3

Press the **▲/▼** buttons to select **Language**, then press the **▶** or **ENTER** button.

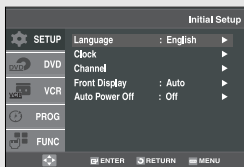

4

Press the **▲/▼** buttons to select the appropriate language: English, Français or Español.
Press the **ENTER** button.

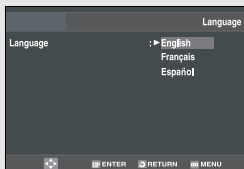

5

Press the **MENU** button to exit.

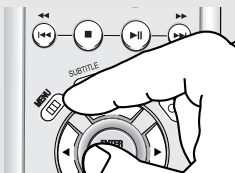

Setting the Clock

This menu is used to set the current time. You need to set the time to use timer recording.

Setting the Clock Automatically

1

Press the **MENU** button.

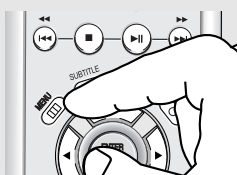

2

Press the **▲/▼** buttons to select **Setup**, then press the **▶** or **ENTER** button.

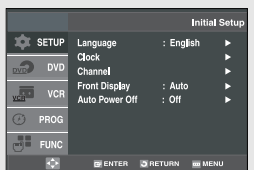

3

Press the **▲/▼** buttons to select **Clock**, then press the **▶** or **ENTER** button.

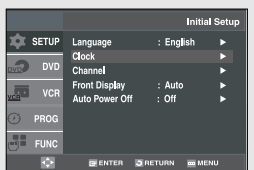

4

Press the **▲/▼** buttons to select **Auto Clock**, then press the **▶** or **ENTER** button.

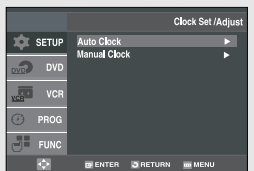

5

Select a channel that carries a time signal by using the **▶** or **ENTER** button.
(Auto, 1, 2, ..., 125)

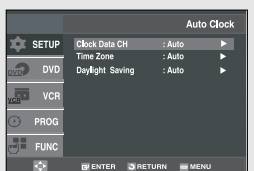

Notes

You must have the antenna connected to set the Auto Clock. (See pages 11~12)

The Clock will be automatically set when you turn off the DVD-VCR.

INITIAL SETUP

6

Press the ▲/▼ buttons to select **Time Zone**, then press the ► or **ENTER** button.

Select the time zone of your area by using the ▲/▼/◀/▶ buttons, then press the **ENTER** button. Select **Automatic** to set the time zone automatically.

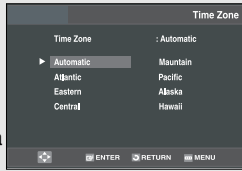

Note

If your clock is set to the wrong Time Zone or Daylight Saving, you can adjust these settings without turning off the Auto Clock Set function.

7

Press the ▲/▼ buttons to select **Daylight Saving**, then press the ► or **ENTER** button to select **Yes**, **No** or **Auto**.



8

Press the **MENU** button to exit.

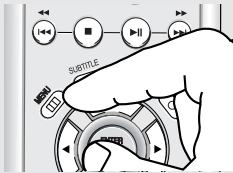

INITIAL SETUP

Setting the Clock Manually

If Auto Setup fails to set the DVD-VCR's internal clock by locating a local TV station, follow these steps to set the date and time manually.

Note: For accurate Timer Recording, your DVD-VCR's internal clock must be set correctly.

1

Press the **MENU** button.

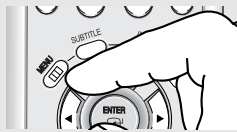

2

Press the **▲/▼** buttons to select **Setup**, then press the **▶** or **ENTER** button.

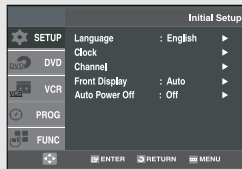

3

Press the **▲/▼** buttons to select **Clock**, then press the **▶** or **ENTER** button.

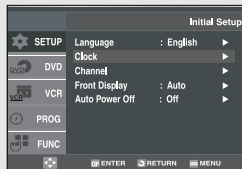

4

Press the **▲/▼** buttons to select **Manual Clock**, then press the **▶** or **ENTER** button.

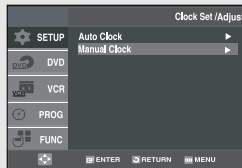

5

Use the **◀/▶** buttons to select each of the following options, then use the **▲/▼** buttons to set each option. Press the **ENTER** button to set the clock.

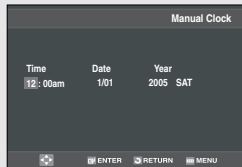

6

Press the **MENU** button to exit.

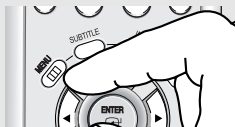

Memorizing the Channels

Selecting the Video Signal-source

This feature allows you to manually set the DVD-VCR's tuner band to Antenna or Cable, whichever you connected to the Antenna In jack during initial setup.

1

Press the **MENU** button.

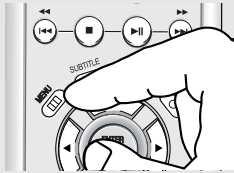

2

Press the ▲/▼ buttons to select **Setup**, then press the ► or **ENTER** button.

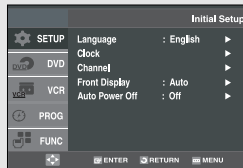

3

Press the ▲/▼ buttons to select **Channel**, then press the ► or **ENTER** button.

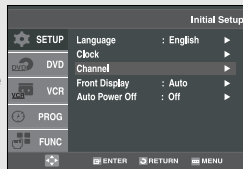

4

Press the ► or **ENTER** button to select **Antenna** or **Cable TV**.

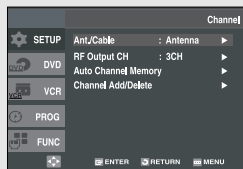

- ◀ - Antenna: Select this if the DVD-VCR is connected to an indoor or outdoor VHF/UHF antenna.
- Cable TV: Select this if the DVD-VCR is connected to Cable TV.

INITIAL SETUP

Storing Channels in Memory (Automatic Method)

Auto Channel Memory will automatically seek and store all active channels in your area.

5

Press the ▲/▼ buttons to select **Auto Channel Memory**, then press the ► or ENTER button.

The DVD-VCR will automatically search for all available channels.

This procedure may take a few minutes to complete.

When finished, the lowest channel found will be displayed.

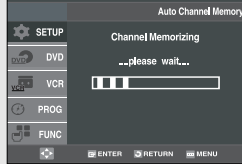
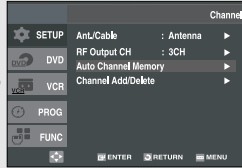

Note

Do not turn the power off when Auto Channel Memory function is proceeding as not all channels will be memorized.

Adding and Erasing Channels (Manual Method)

Use this feature if Auto Channel Search missed a channel that you would like to add, delete a channel you wish to remove.

6

Press the ▲/▼ buttons to select **Channel Add/Delete**, then press the ► or ENTER button.

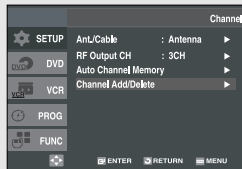

7

Press the CH ▲/▼ buttons to tune in the channel number you wish to add or delete. Use the number button to select the channel directly.



8

Press the ◀ or ▶ button to delete the channel from your channel list or to add.

Repeat steps 7 to add or to delete additional channels.

Press the **MENU** button to exit.



Note

Use the number button to move the channel directly.

Selecting the RF Output Channel

Use this feature if DVD-VCR is connected to TV using RF antenna cable.

1

Press the **MENU** button.

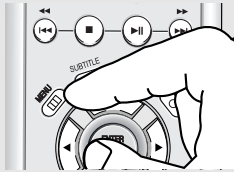

2

Press the ▲/▼ buttons to select **Setup**, then press the ► or **ENTER** button.



3

Press the ▲/▼ buttons to select **Channel**, then press the ► or **ENTER** button.

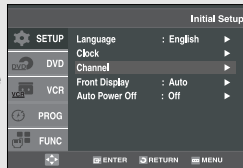

4

Press the ▲/▼ buttons to select **RF Output CH**, then press the ► or **ENTER** button to select **3CH** or **4CH**.

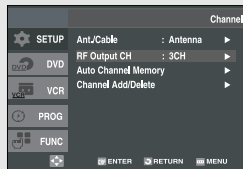

5

Press the **MENU** button to exit.



Setting the Front Panel Display

You can set the Front Panel Display to be bright all the time, dim all the time, or to automatically dim during power off.

1

Press the **MENU** button.

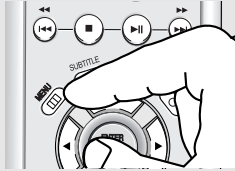

2

Press the ▲/▼ buttons to select **Setup**, then press the ► or **ENTER** button.

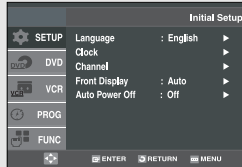

3

Press the ▲/▼ buttons to select **Front Display**, then press the ► or **ENTER** button to select **Auto**, **Bright** or **Dim**.



4

Press the **MENU** button to exit.

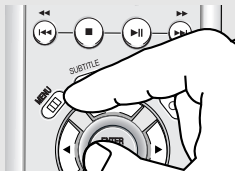

- **Auto:** Front Panel Display will dim automatically during power off.
- **Bright:** Front Panel Display will be bright all the time.
- **Dim:** Front Panel Display will be dim all the time.

Setting the Power Off Automatically

This feature automatically turns off your DVD-VCR if no signal is received and you do not press any buttons for the selected time.

1

Press the **MENU** button.

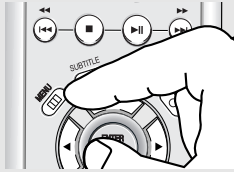

2

Press the ▲/▼ buttons to select **Setup**, then press the ► or **ENTER** button.



3

Press the ▲/▼ buttons to select **Auto Power Off**, then press the ► or **ENTER** button to select **Off**, **1Hr** or **2Hr**.

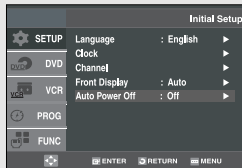

4

Press the **MENU** button to exit.



- Off: Auto power off is disabled.
- 1Hr: DVD-VCR will auto shut off 1 hour after the last button is pressed or no signal is received.
- 2Hr: DVD-VCR will auto shut off 2 hours after the last button is pressed or no signal is received.

Chapter 4

DVD OPERATIONS

Playing a Disc

Before Play

- Turn on your TV and set it to the correct Video Input on your TV's remote control.
- If you connected an external Audio System, turn on your Audio System and set it to the correct Audio Input.

Playback

1

Press the **OPEN/CLOSE** (▲) button.

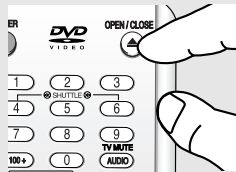

2

Place a disc gently into the tray with the disc's label facing up.

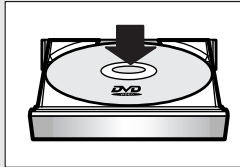

3

Press the **▶||** (Play/Pause) button on your remote control or on the front panel.

Most discs will start to play back as soon as the tray closes.



4

Stopping Play

Press the **■** (Stop) button during play.



◀ Stop/Resume

- Press the **■** (Stop) button once to stop playback. To resume the DVD/CD from the point where the disc stopped, press the **▶||** (Play/Pause) button.
- Press the **■** (Stop) button twice to completely stop playback. The next time you press the **▶||** (Play/Pause), the disc will start over from the beginning.

DVD OPERATIONS

5

Pausing Play

Press the **▶||** (Play/Pause) button on your remote control or on the front panel during play.

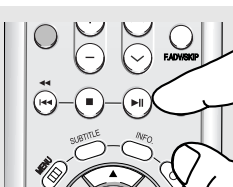

- ◀ - Screen stops, no sound.
- To resume, press the **▶||** (Play/Pause) button once again.

Note

If the player is left for about 5 minutes in pause mode, it will stop.

6

Step Motion Play (Except CD)

Press the **F.ADV** button on the remote control during play.

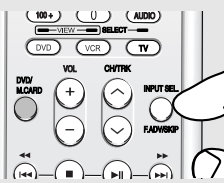

- ◀ - Each time the button is pressed, a new frame will appear.
- No sound is heard during STEP mode.
- Press the **▶||** (Play/Pause) button to resume normal play.
- You can only perform step motion play in the forward direction.

7

Slow Motion Play (Except CD)

Press and hold the **▶▶** (Forward) button to choose the play speed between 1/8, 1/4 and 1/2 of normal during PAUSE or STEP mode.

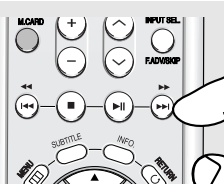

- ◀ - No sound is heard during slow mode.
- Press the **▶||** (Play/Pause) button to resume normal play.
- Reverse slow motion play will not work.

Note

This (⊙) icon indicates an invalid button press.

8

To remove the Disc

Press the **OPEN/CLOSE** (▲) button.

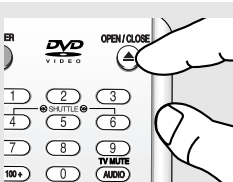

Using the Search and Skip Functions

During play, you can search quickly through a chapter or track, and use the skip function to jump to the next selection.

Searching through a Chapter or Track

During play, press and hold the ◀◀ / ▶▶ (Search) buttons on the remote control for more than 1 second.

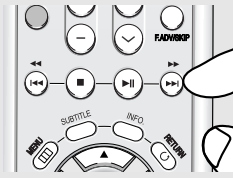

◀ If you want to search at a faster speed on the DVD or CD, press and hold the button.

| | |
|-----|-------------------|
| DVD | 2X, 8X, 32X, 128X |
| CD | 2X, 4X, 8X |

Notes

- The speed marked in this function may be different from the actual playback speed.
- No sound is hearing during search mode (Except CD).

Skipping Tracks

During play, press the ◀◀ / ▶▶ (Skip) buttons.

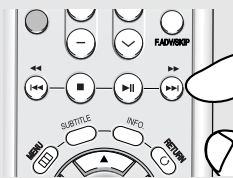

- When playing a DVD, if you press the ▶▶ (Skip) button, it moves to the next chapter. If you press the ◀◀ (Skip) button, it moves to the beginning of the current chapter. One more press makes it move to the beginning of the previous chapter.

Using the Display Function

When Playing a DVD/CD

1

During play, press the **INFO.** button on the remote control.

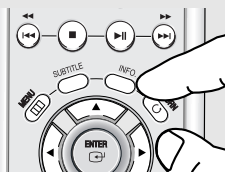

◀ You can select information in the DVD Function menu by pressing the **INFO** button.

2

Press the **▲/▼** buttons to select the desired item.

DVD

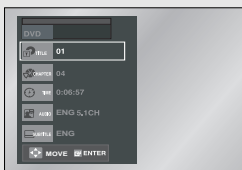

CD



3

Press the **◀▶** buttons to make the desired setup and then press the **ENTER** button.

◀ You may use the number buttons of the remote control to directly access a title, chapter or to start the playback from a desired time.





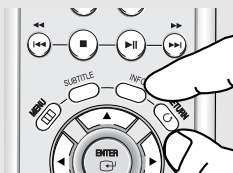

4

To exit the menu, press the **INFO.** button again.



DVD OPERATIONS

Note

| | |
|--|---|
|  | To access the desired title when there is more than one in the disc. For example, if there is more than one movie on a DVD, each movie will be identified. |
|   | Most DVD discs are recorded in chapters so that you can quickly find a specific passage (similar to tracks on an audio CD). |
|  | Allows playback of the film from a desired time. You must enter the starting time as a reference. The time search function does not operate on some discs. |
|  | Refers to the film's soundtrack language. In the example, the soundtrack is played in English 5.1CH. A DVD disc can have up to eight different soundtracks. |
|  | Refers to the subtitle languages available in the disc. You will be able to choose the subtitle languages or, if you prefer, turn them off from the screen. A DVD disc can have up to 32 different subtitles. |

Using the Disc and Title Menu (DVD)

1

During playback of a DVD disc, press the **MENU** button on the remote control.

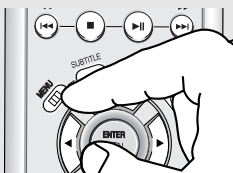

◀ MENU button can be used to access Disc and title menus on a DVD during playback.

2

Press the ▲/▼ buttons to select **Function**, then press the ► or **ENTER** button.



3

Press the ▲/▼ buttons to select **DVD Function**, then press the ► or **ENTER** button.



4

Press the ▲/▼ buttons to select **Title Menu** or **Disc Menu** then press the ► or **ENTER** button.

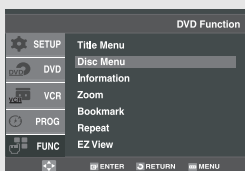

Notes

- Depending on the disc, the Disc Menu or Title Menu may not be available.
- You can also use the Disc Menu by using the DISC MENU button on the remote control.
- Title Menu will only be displayed if there are at least two titles in the disc.

Using the Function Menu (DVD)

1

During the playback of a DVD disc, press the **MENU** button on the remote control.

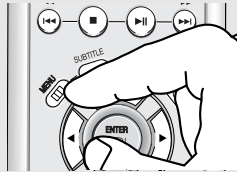

◀ MENU button can be used to access DVD functions such as Information, Zoom, Bookmark, Repeat and EZ view menu during DVD playback.

2

Press the ▲/▼ buttons to select **Function**, then press the ► or **ENTER** button.

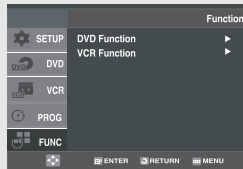

3

Press the ▲/▼ buttons to select **DVD Function**, then press the ► or **ENTER** button.

- Information
(See pages 32 to 33)
- Zoom (See page 45)
- Bookmark
(See pages 43 to 44)
- Repeat (See pages 36 to 37)
- EZ View
(See pages 39 to 40)

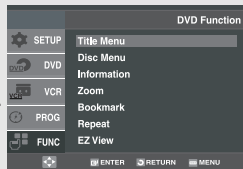

4

Press the ▲/▼ buttons to select one of the five functions. Then press the ► or **ENTER** button to access the function.

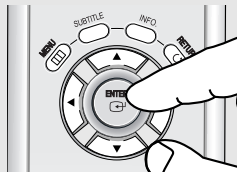

◀ You can also directly select these functions using their respective buttons on the remote control.

- Info
- MARK
- REPEAT

Repeat Play

Repeat the current track, chapter, title, a chosen section (A-B), or all of the disc.

When playing a DVD/CD

1

During play, press the **REPEAT** button on the remote control. Repeat screen appears.

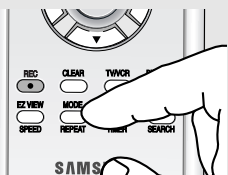

2

Press the ◀▶ buttons to select **Chapter**, **Title** or **A-B**, then press the **ENTER** button.

DVD

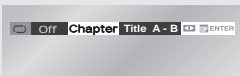

CD

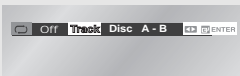

- ◀ DVD repeats play by chapter or title, and CD repeats play by track or disc.
- Chapter: repeats the chapter that is playing.
 - Title: repeats the title that is playing.
 - Track: repeats the track that is playing.
 - Disc: repeats the disc that is playing.
 - A-B: repeats a segment of the disc that you select.

3

To return to normal play, press the **REPEAT** button again, then press the ◀▶ buttons to select **Off** and press **ENTER** button.

It's available to press the **CLEAR** button in order to stop repeat play.

DVD

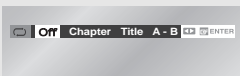

CD

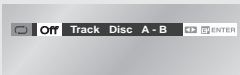

Note

Depending on a disc, the Repeat function may not work.

Using the A-B Repeat function

1

During play, press the **REPEAT** button on the remote control. Repeat screen appears.

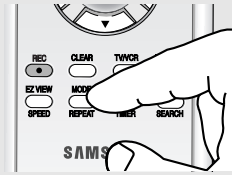

2

Press the ◀▶ buttons to select **A**.

DVD

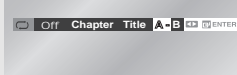

CD

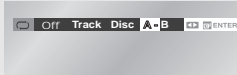

3

Mark the Starting Point

Press the **ENTER** button at the beginning of the segment you want to repeat (Point A). Once you select point **A**, **B** will be selected.

DVD

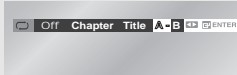

CD

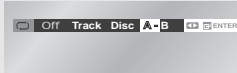

Note

The minimum A-B Repeat time is 5 seconds.

4

Mark the Ending Point

Press the **ENTER** button again at the end of the segment you want to repeat (Point B).

The segment will begin repeating in a continuous loop.

DVD

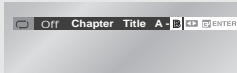

CD

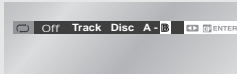

5

Cancel A-B Repeat

Press the **REPEAT** button, then press the ◀▶ buttons to select **Off** and press **ENTER** button.

DVD

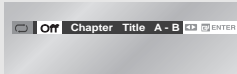

CD

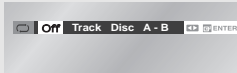

Slow Repeat Play

This feature allows you to slowly to repeat scenes containing sports, dancing, musical instruments being played etc., so you can study them more closely.

When playing a DVD

1

During play, press the **▶||** (Play/Pause) button.

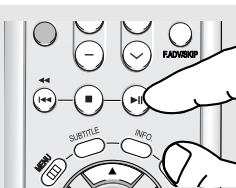

2

Press and hold the **▶▶** (Forward) button to choose the play speed between 1/8, 1/4 and 1/2 of normal during PAUSE or STEP mode.

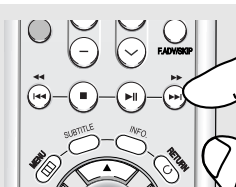

3

Press the **REPEAT** button on the remote control. Press the **◀▶** buttons to select **A-**.

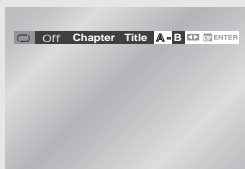

4

Press the **ENTER** button at the point where you want repeat play to start (A). **B** is automatically selected. Press the **ENTER** button at the point where you want the repeat play to stop (B).

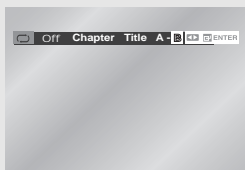

5

To return to normal play, press the **REPEAT** button, then press the **◀▶** buttons to select **Off** and press **ENTER** button.

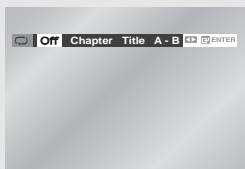

- ◀ To set A-B repeat, set (A) first, then set (B) after the following slow play time has elapsed:
1/8x: wait 40 seconds, then press B
1/4x: wait 20 seconds, then press B
1/2x: wait 10 seconds, then press B

- ◀ The disc will play from A to B repeatedly at the speed you chose.

Adjusting the Aspect Ratio (EZ View)

Set the aspect ratio (length x width) of your TV screen so the DVD-VCR will display movies at the appropriate size for your television.

To Playback using Aspect Ratio (DVD)

Press the **EZ VIEW** button.

- The screen size changes when the button is pressed repeatedly.
- The screen zoom mode operates differently depending on the screen setting in the Display Setup menu.
- To ensure correct operation of the **EZ VIEW** button, you should set the correct aspect ratio in the Display Setup menu. (See pages 58 to 59).

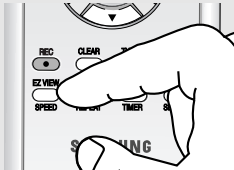

◀ The EZ View feature is not available when the A-B Repeat function is activated.

If you are using a 16:9 TV

For 16:9 aspect ratio discs

- **WIDE SCREEN**
Displays the content of the DVD title in 16:9 aspect ratio.
- **SCREEN FIT**
The top and bottom portions of the screen are cut off. When playing a 2.35:1 aspect ratio disc, the black bars at the top and bottom of the screen will disappear. The picture will look vertically stretched. (Depending on a type of disc, the black bars may not disappear completely.)
- **ZOOM FIT**
The top, bottom, left and right of the screen are cut off and the central portion of the screen is enlarged.

For 4:3 aspect ratio discs

- **NORMAL WIDE**
Displays the content of the DVD title in 16:9 aspect ratio. The picture will look horizontally stretched.
- **SCREEN FIT**
The top and bottom portions of the screen are cut off and the full screen appears. The picture will look vertically stretched.

- **ZOOM FIT**

The top, bottom, left and right portions of the screen are cut off and the central portion of the screen is enlarged.

- **VERTICAL FIT**

When a 4:3 DVD is viewed on a 16:9 TV, black bars will appear at the left and right of the screen in order to prevent the picture from looking horizontally stretched.

If you are using a 4:3 TV

For 16:9 aspect ratio discs

- **4:3 Letter Box**

Displays the content of the DVD title in 16:9 aspect ratio. The black bars will appear at the top and bottom of the screen.

- **4:3 Pan Scan**

The left and right portions of the screen are cut off and the central portion of the 16:9 screen is displayed.

- **SCREEN FIT**

The top and bottom portions of the screen are cut off and a full screen appears. The picture will look vertically stretched.

- **ZOOM FIT**

The top, bottom, left and right of the screen are cut off and the central portion of the screen is enlarged.

For 4:3 aspect ratio discs

- **NORMAL SCREEN**

Displays the content of the DVD title in 4:3 aspect ratio.

- **SCREEN FIT**

The top and bottom portions of the screen are cut off and the full screen appears. The picture will look vertically stretched.



- **ZOOM FIT**

The top, bottom, left and right portions of the screen are cut off and the central portion of the screen is enlarged.

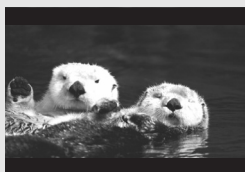

Note

This function may behave differently depending on the type of disc.

Selecting the Audio Language

You can select a desired audio language quickly and easily with the AUDIO button.

Using the AUDIO button (DVD/CD)

1

During play, press the **AUDIO** button. Audio languages changes when the ◀▶ button is pressed repeatedly.

The audio languages are represented by abbreviations.



DVD



CD



When playing a CD, you can select among **Stereo**, **Right** or **Left**.

Notes

- To change the desired audio in the Disc Menu, press the **DISC MENU** button.
- This function depends on what audio languages are encoded on the disc and may not work on all DVDs.
- A DVD disc can contain up to 8 audio languages.
- To have the same audio language come up whenever you play a DVD, see pages 54 to 55.

2

To remove the AUDIO icon, press the **AUDIO**, **CLEAR** or **RETURN** button.

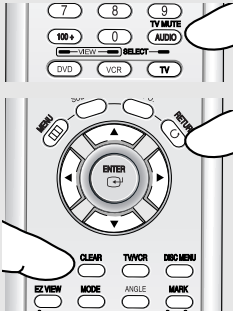

Selecting the Subtitle Language

You can select a desired subtitle quickly and easily with the SUBTITLE button.

Using the SUBTITLE button (DVD)

1

During play, press the **SUBTITLE** button.

The subtitle changes when the ◀/▶ button is pressed repeatedly.

The subtitle languages are represented by abbreviations.



2

To remove the **SUBTITLE** icon, press the **SUBTITLE**, **CLEAR** or **RETURN** button.

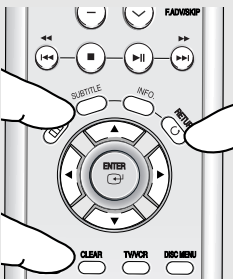

Notes

- To change the desired subtitle in the Disc Menu, press the **DISC MENU** button.
- This function depends on what subtitles are encoded on the disc and may not be available on all DVDs.
- A DVD disc can contain up to 32 subtitle languages.
- To have the same subtitle language come up whenever you play a DVD, see pages 54 to 55.

Changing the Camera Angle

When a DVD contains multiple angles of a particular scene, you can use the ANGLE function.

Using the ANGLE button (DVD)

If the disc contains multiple angles, the ANGLE (⌂) icon appears on the screen.

1

Press the **ANGLE** button, then the ANGLE icon will appear with the current angle number and the number of angles available.

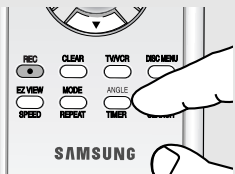

2

Press the ◀/▶ buttons repeatedly to select the desired angle. To remove the ANGLE icon, press the **CLEAR** or **RETURN** button.



Note

If the disc has only one angle, this feature won't work. Currently, very few discs have this feature.

Using the Bookmark Function

This feature lets you bookmark sections of a DVD so you can quickly find them at a later time.

Using the MARK button (DVD)

1

During play, press the **MARK** button on the remote control.

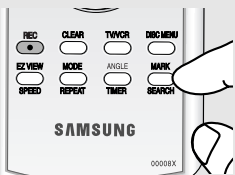

2

When you reach the scene you want to mark, press the **ENTER** button. Up to three scenes may be marked at a time.



Note

Depending on a disc, the Bookmark function may not work.

Recalling a Marked Scene

1

During play, press the **MARK** button on the remote control.

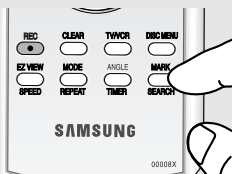

2

Press the ◀▶ buttons to select a marked scene.



3

Press the ▶◻▶ (Play/Pause) button to skip to the marked scene.

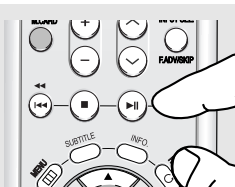

Clearing a Bookmark

1

During play, press the **MARK** button on the remote control.

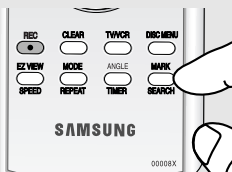

2

Press the ◀▶ buttons to select the bookmark number you want to delete.



3

Press the **CLEAR** button to delete a bookmark number.

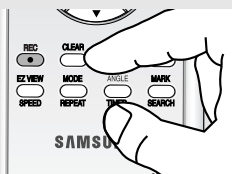

Using the Zoom Function (DVD)

1

During the playback of a DVD disc, press the **MENU** button on the remote control.

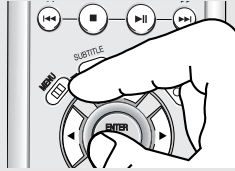

2

Press the **▲/▼** buttons to select **Function**, then press the **▶** or **ENTER** button.



3

Press the **▲/▼** buttons to select **DVD Function**, then press the **▶** or **ENTER** button.

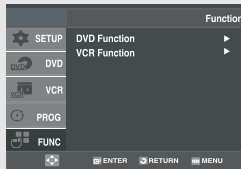

4

Press the **▲/▼** buttons to select **Zoom**, then press the **▶** or **ENTER** button.



5

Press the **▲/▼** or **◀▶** buttons to select the part of the screen you want to zoom in on.

Press the **ENTER** button.

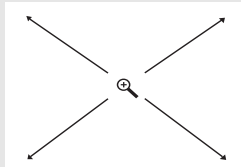

◀ During DVD play, press **ENTER** to zoom in 2X/4X/2X/Normal in order.

Note

Depending on a disc, the Zoom function may not be available.

How to insert a Memory Card

This unit accepts 10 different types of Memory Cards

Insert the Memory Card correctly with the label facing up, otherwise it may not work.

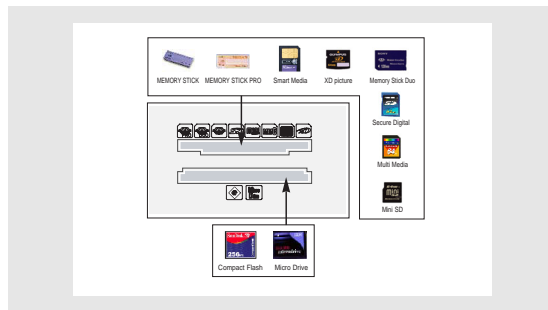

This device supports 10 types of memory cards :MMC, SD, Smart Media Card, Memory Stick, Memory Stick-Pro, Memory Stick Duo, Mini SD Card ,XD-Picture Card. through the upper slot and Compact Flash, Micro Drive through the lower slot.

If cards are inserted in both slots, the Compact Flash or Micro Drive in the the lower slot has priority. We recommend you only insert one Memory Card at a time in the unit.

Notes

- Memory Cards over 4GB use FAT 32, which may not be compatible with this unit.
- If it is not fully inserted, the Memory Card will not be detected.
- If you remove the Memory Card during Memory Card operation, the recorded data may become corrupted. It is better to remove it after pressing DVD/M.CARD button to return to DVD/CD Mode.
- Some memory cards may not be compatible.

When playing a Memory Card

1

Insert a Memory Card.

2

Press the **DVD/M.CARD** button on the remote control.

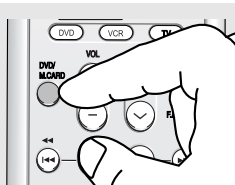

3

Depending on the file type stored on the Memory card, audio files will be played the same way as MP3/WMA files and picture files will be played the same way as Picture CD files.(See pages 47 to 52)

Clips Menu for MP3/WMA/JPEG

Discs with MP3/WMA/JPEG contain individual songs and/or pictures that can be organized into folders as shown below. They are similar to how you use your computer to put files into different folders.

1
Open the disc tray.

2
Place the disc on the tray.

3
Close the tray.
The tray closes and this screen displays.

- : Name of currently playing file.
- : Current Playback Time.
- : Current Playback Mode : There are four modes. They can be selected in order by pressing the REPEAT button.
 - Off: Normal Playback
 - Track: Repeats the current track.
 - Folder: Repeats the current folder.
 - Random: Files in the disc will be played in random order.
- : MP3 file icon.
- : WMA file icon.
- : JPEG file icon.
- : Folder icon.
- : Current Folder icon.
- : Disc mode (: Memory Card Mode)

Folder Selection

The folder can only be selected in the Stop mode.

- **To select the Parent Folder**
Press the **RETURN** button to go to the parent folder, or press the **▲/▼** buttons to select “..” and press the **ENTER** button to go to the parent folder.
- **To select the Peer Folder**
Press the **◀/▶** buttons to highlight the left window. Press the **▲/▼** buttons to select the desired folder, then the **ENTER** button.
- **To select the Sub-Folder**
Press the **◀/▶** buttons to highlight the right window. Press the **▲/▼** buttons to select the desired folder, then press the **ENTER** button.

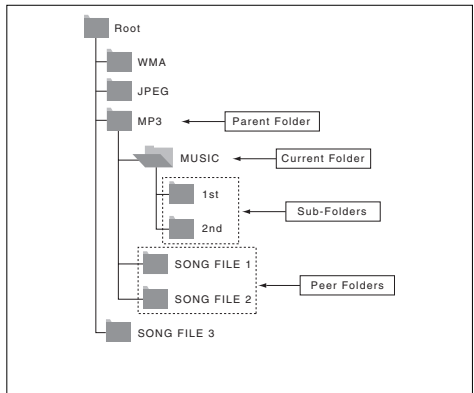

MP3/WMA Playback

1

Open the disc tray.

2

Place the disc on the tray.

3

Close the tray.

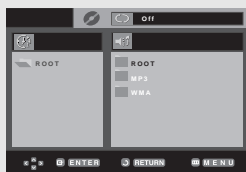

4

Press the ▲/▼ or ◀▶ buttons to select a song file.

Press the **ENTER** button to begin playback of the song file.



◀ When a disc or a folder contains both MP3 and WMA files, only one type will be played, not both.

Notes

- A DVD/CD cannot be played in the Memory Card mode. If you push the DVD/M.CARD or OPEN button in M.CARD mode, the system will automatically enter the DVD/CD mode.
- Depending on the recording method, some MP3 CD-Rs may not be played.
- When pushing the DVD/M.CARD button to play disc again, the player doesn't remember where you stopped.
- It is impossible to write MP3 or JPEG files to a Memory Card in this unit as it is read only.
- Only MP3/WMA Format files with the “.mp3 and .wma” extensions can be played.

Repeat/Random playback

During play, press the **REPEAT** button to change the playback mode. There are four modes.

Off, Track, Folder and Random.

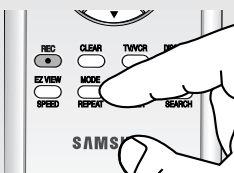

- Off: Normal Playback
- Track: Repeats the current song file.
- Folder: Repeats the song files which have the same extension in the current folder.
- Random: Song files which have the same extension will be played in random order.

To resume normal play, press the **CLEAR** button.

MP3/WMA file

When you record MP3 or WMA files on CD-R/Memory Card, please refer to the following.

- **Your MP3 or WMA files should be ISO 9660 or JOLIET format.**

ISO 9660 format and Joliet MP3 or WMA files are compatible with Microsoft's DOS and Windows, and with Apple's Mac. This format is the most widely used. Memory Cards over 4GB use FAT32, which may not be compatible with this unit.

- **When naming your MP3 or WMA files, do not exceed 8 characters, and enter ".mp3, .wma" as the file extension.**

General name format : Title.mp3. or Title.wma. When composing your title, make sure that you use 8 characters or less, have no spaces in the name, and avoid the use of special characters including: (,/, \, =, +).

- **Use a decompression transfer rate of at least 128 Kbps when recording MP3 files.**

Sound quality with MP3 files basically depends on the rate of compression/decompression you choose. Getting CD audio sound requires an analog/digital sampling rate, that is conversion to MP3 format, of at least 128 Kbps and up to 160 Kbps. However, choosing higher rates, like 192

Kbps or more, only rarely give better sound quality. Conversely, files with decompression rates below 128 Kbps will not be played properly.

- **Use a decompression transfer rate of at least**

- **64Kbps when recording WMA files.**

Sound quality with WMA files basically depends on the rate of compression/decompression you choose.

Getting CD audio sound requires an analog/digital sampling rate, that is conversion to WMA format, of at least 64Kbps and up to 192Kbps.

Conversely, files with decompression rates below 64Kbps or over 192Kbps will not be played properly.

- **Do not try recording copyright protected MP3 files.**

Certain "secured" files are encrypted and code protected to prevent illegal copying. These files are of the following types: Windows Media™ (registered trade mark of Microsoft Inc) and SDMITM (registered trade mark of The SDMI Foundation). You cannot copy such files.

- **Important:**

The above recommendations cannot be taken as a guarantee that the DVD-VCR will play MP3 recordings, or as an assurance of sound quality. You should note that certain technologies and methods for MP3 file recording on CD-Rs prevent optimal playback of these files on your DVD-VCR (degraded sound quality and in some cases, inability of the player to read the files).

- This unit can play a maximum of 3000 files and 300 folders per disc.

Program Play & Random Play

You can listen to songs randomly or in the desired sequence.

Up to 20 tracks can be programmed.

This function is available only with Audio CDs.

Program Play

1

With the unit in stop mode, press the **REPEAT** button.

- The play mode menu will appear.

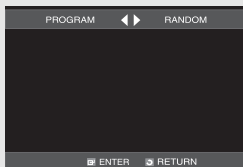

2

Press the ◀ or ▶ buttons to select **PROGRAM**, then press the **ENTER** button.

- The program play screen will appear.

3

Press the ▲/▼ or ◀▶ buttons to select the desired track, then press the **ENTER** button.

- The selected track will be added to the Program order.
- If you delete the track, press the **CLEAR** button.
The track added last will be deleted from the Program order.

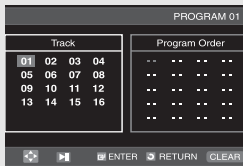

4

To finish programming and start playback, press the ▶|| button.

The disc will be played in programmed order.

Note

Random Play

- With the unit in stop mode, press the **REPEAT** button.
- The play mode menu will appear.
- Press the ◀ or ▶ buttons to select Random, then press the **ENTER** button.
- The disc will be played in random order.

Note

If the disc tray is opened during programming, program play will be canceled.

• To Cancel Programming

- Press the **REPEAT** button.
The program will not be saved and the program screen will disappear.

• To Cancel Program Play

- During playback or in Stop mode, press the **CLEAR** button.

Picture CD Playback

1

Select the desired folder, then press the **ENTER** button.



2

Press the **▲/▼** buttons to select a Picture file in the clips menu, then press the **ENTER** button.



3

Press the **INFO.** button to display the menu.

Press the **◀/▶** buttons to select the menu you want to view, then press the **ENTER** button.

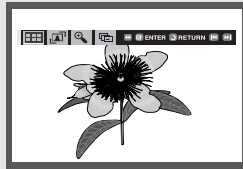

Notes

- If no buttons on the remote control are pressed for 10 seconds, the menu will disappear.
- Press the **■** (Stop) button to return to the clips menu.
- When playing a Kodak Picture CD, the unit displays the Photo directly, not the clips menu.

Album Screen

- : Returns to the Album Screen.
- To see the next six pictures, press the **▶▶** (Skip) button.
- To see the previous six pictures, press the **◀◀** (Skip) button.

Rotation

- : Each time the **ENTER** button is pressed, the picture rotates 90 degrees clockwise.

Zoom

- : Press the **▲/▼** or **◀/▶** buttons to select the part of the screen you want to zoom in on. Press the **ENTER** button. Each time the **ENTER** button is pressed, the picture is enlarged up to 4X. (2X → 4X → 2X → Normal)

Slide Show

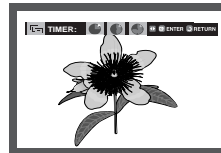

- : The unit enters slide show mode.
- Before beginning the Slide Show, the picture interval must be set.
- : When this icon is selected and **ENTER** is pressed, the pictures change automatically with about a 6 second interval.
- : The pictures change automatically with about a 12 second interval.
- : The pictures change automatically with about a 18 second interval.

Notes

- Depending on a file size, the amount of time between each picture may be different from the set interval time.
- If you don't press any button, the slide show will start automatically in about 10 seconds by default.

JPEG Discs

When playing a CD-R/Memory Card/Picture CD

- Only files with the “.jpg” and “.JPG” extensions can be played.
- If the disc is not closed, it will take longer to start playing and not all of the recorded files may be played.
- Only CD-R discs with JPEG files in ISO 9660 or Joliet format can be played.
- Memory Cards over 4GB use FAT32, which may not be compatible with this unit.
- Some memory cards may not perform correctly.
- The name of the JPEG file may not be longer than 8 characters and should contain no blank spaces or special characters (. / = +).
- Only a consecutively written multi-session disc can be played. If there is a blank segment in the multi-session disc, the disc can be played only up to the blank segment.
- A maximum of 3000 images can be stored on a single CD.
- Kodak Picture CDs are recommended.
- When playing a Kodak Picture CD, only the JPEG files in the pictures folder can be played.
- Kodak Picture CD: The JPEG files in the pictures folder can be played automatically.
- Konica Picture CD: If you want to see the Picture, select the JPEG files in the clips menu.
- Fuji Picture CD: If you want to see the Picture, select the JPEG files in the clips menu.
- QSS Picture CD: The unit may not play QSS Picture CD.
- If the number of files in 1 Disc is over 3000, only the first 3000 JPEG files can be played.
- If the number of folders in 1 Disc is over 300, only JPEG files in the first 300 folders can be played.

Using the Setup Menu

The Setup menu lets you customize your DVD-VCR by allowing you to select various language preferences, set up a parental level, even adjust the player to the type of television screen you have.

1

With the unit in Stop mode, press the **MENU** button on the remote control.

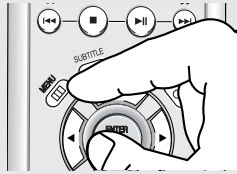

2

Press the ▲/▼ buttons to select **DVD**, then press the ► or **ENTER** button.

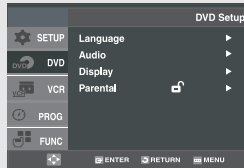

- ❶ Language: Setup of the Language.
- ❷ Audio: Setup of the Audio Options.
- ❸ Display: Setup of the Display Options. Used to select which type of screen you want to watch and several display options.
- ❹ Parental: Setup of the Parental Level. Allows users to set the level necessary to prevent children from viewing unsuitable movies such as those with violence, adult subject matter, etc.

3

Press the ▲/▼ buttons to access the different features. Press the ► or **ENTER** button to access the sub features.

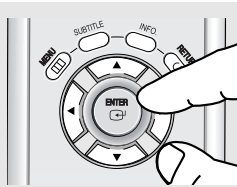

4

To make the DVD setup screen disappear after setting up, press the **MENU** button again.

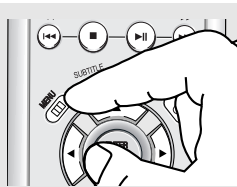

Note

Depending on the disc, some DVD Setup menu selections may not be available.

Setting Up the Language Features

If you set the audio and subtitle language in advance, they will come up automatically every time you watch a movie.

1

With the unit in Stop mode, press the **MENU** button on the remote control.

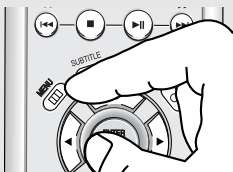

2

Press the ▲/▼ buttons to select **DVD**, then press the ► or **ENTER** button.

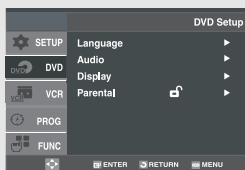

3

Press the ▲/▼ buttons to select **Language**, then press the ► or **ENTER** button.

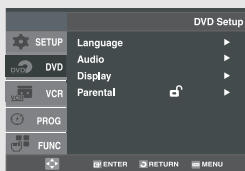

4

Press the ▲/▼ buttons to select the desired item, then press the ► or **ENTER** button.

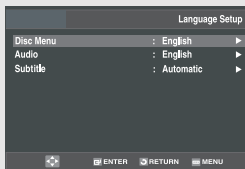

5

Press the ▲/▼ buttons to select the desired language, then press the ► or **ENTER** button.



- ◀ - The language is selected and the screen returns to Language Setup menu.
- To make the DVD Setup menu disappear, press the MENU button.

Language Function

Disc Menu

To set the Disc Menu Language to your preferred language, follow these steps. If your preferred language is available on a DVD, your Disc Menu Language will automatically be set to the language you choose.



- ◀ - Select “Others” if the language you want is not listed.
- If the selected language is not recorded on the disc, the original pre-recorded language is selected.

Audio

To set the Audio Language to your preferred language, follow these steps. If your preferred language is available on a DVD, your Audio Language will automatically be set to the language you choose.



- ◀ - Select “Original” if you want the default soundtrack language to be the original language the disc is recorded in.
- Select “Others” if the language you want is not listed.
- If the selected language is not recorded on the disc, the original pre-recorded language is selected.

Subtitle

To set the Subtitle Language to your preferred language, follow these steps. If your preferred language is available on a DVD, your Subtitle Language will automatically be set to the language you choose.

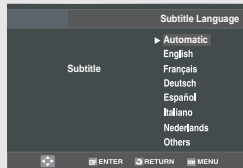

- ◀ - Select “Automatic” if you want the subtitle language to be the same as the language selected as the audio language.
- Select “Others” if the language you want is not listed. Some discs may not contain the language you select as your initial language; in that case the disc will use its original language setting.

Setting Up the Audio Options

Audio Options allows you to set up sound for use with your external audio system.

1

With the DVD in Stop mode, press the **MENU** button on the remote control.

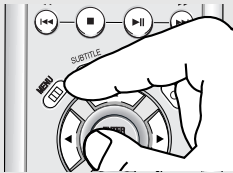

2

Press the ▲/▼ buttons to select **DVD**, then press the ► or **ENTER** button.



3

Press the ▲/▼ buttons to select **Audio**, then press the ► or **ENTER** button.



4

Press the ▲/▼ buttons to select the desired item, then press the ► or **ENTER** button.

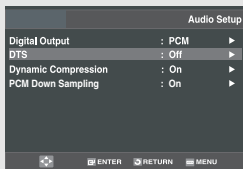

◀ - To make the DVD Setup menu disappear, press the MENU button.

Audio Options

Digital Output

- PCM: Converts to PCM(2CH) audio.
- Bitstream: Outputs Dolby Digital via the digital output. Select Bitstream when connecting to a Dolby Digital Decoder.

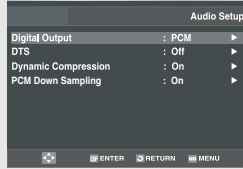

Note

There is no analog audio output when you play a DTS disc.

Manufactured under license from Dolby Laboratories. "Dolby" and the double-D symbol are trademarks of Dolby Laboratories.
 "DTS" and "DTS Digital Out" are trademarks of Digital Theater Systems, Inc.

DTS

Select On when connecting to a DTS Decoder.

- Off: Doesn't output digital signal.
- On: Outputs DTS Bitstream via digital output.

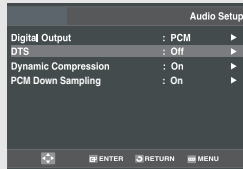

Note

There is no analog audio output when you play a DTS sound disc.

Dynamic Compression

- On: To select dynamic compression.
- Off : To select the standard range.

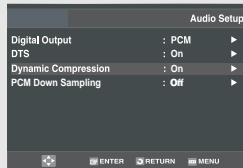

- ◀ - Dynamic compression restrains the dynamic range of the sound, i.e. the difference between the loud and quiet passages of a DVD audio track. This is useful when watching a DVD late at night.

PCM Down Sampling

- On: Select this when the Amplifier connected to the player is not 96KHz compatible. In this case, the 96KHz signals will be down converted to 48KHZ.
- Off: Select this when the Amplifier connected to the player is 96KHz compatible. In this case, all signals will be output without any changes.

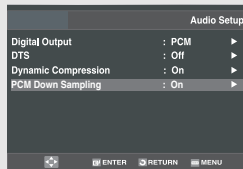

Note

Even when PCM Down sampling is Off, some discs will still output down sampled (48KHZ) audio through the digital outputs.

Setting Up the Display Options

Display options enable you to set various video functions of the player.

1

With the unit in Stop mode, press the **MENU** button on the remote control.

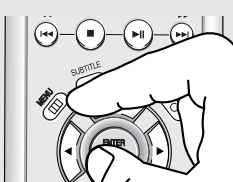

2

Press the ▲/▼ buttons to select **DVD**, then press the ► or **ENTER** button.

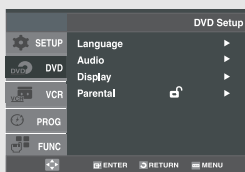

3

Press the ▲/▼ buttons to select **Display**, then press the ► or **ENTER** button.



4

Press the ▲/▼ buttons to select the desired item, then press the ► or **ENTER** button.

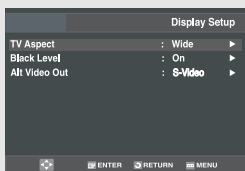

◀ - To make the DVD Setup menu disappear, press the MENU button.

Display Options

TV Aspect

Depending on the type of television you have, you may want to adjust the screen setting (aspect ratio).

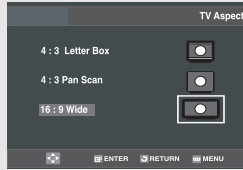

- 4:3 Letter Box: Select when you want to see the total 16:9 ratio screen DVD supplies, even though you have a TV with a 4:3 ratio screen. Black bars will appear at the top and bottom of the screen.
- 4:3 Pan Scan: Select this for conventional size TVs when you want to see the central portion of the 16:9 screen. (Extreme left and right side of movie picture will be cut off.)
- 16:9 Wide: You can view the full 16:9 picture on your wide screen TV.

Black Level

The Black Level feature adjusts black reference level in the video signal to one of two choices:



- On: This will enhance the Black Level for increased brightness/contrast when viewing DVDs.
- Off: This is the Standard NTSC reference Black Level for consistent brightness/contrast across all sources.

Alt Video Out

The "Alt Video Out" option must be set in the on-screen menu if you have connected your DVD-VCR to a TV using the S-VIDEO OUT or COMPONENT VIDEO OUT jacks.

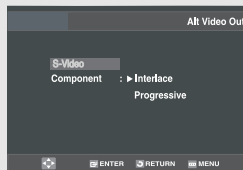

- S-Video: Select when you want to use S-Video output.
- Component: Select when you want to use Component interlace(525i) Out or Progressive(525p) Out.

Note

It cannot be adjusted when Alt Video Out is set to Progressive.

- ◀ - See your TV owner's manual to determine what type of TV you have.
- Interlace: Interlaced Scan mode will work.
- Progressive: Progressive Scan mode will work, and Video and S-Video will not work.
- Press the **P.SCAN** button on the front panel in stop mode. Be sure to set the correct Video output for the proper picture.

Setting Up the Parental Control

The Parental Control function works in conjunction with DVDs that have been assigned a rating, which helps you control the types of DVDs that your family watches. There are up to 8 rating levels on a disc.

1

With the DVD in Stop mode, press the **MENU** button on the remote control.

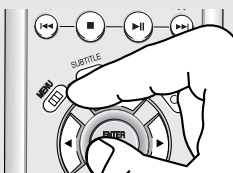

2

Press the **▲/▼** buttons to select **DVD**, then press the **▶** or **ENTER** button.

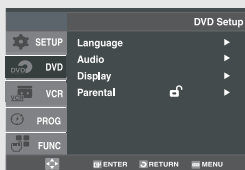

3

Press the **▲/▼** buttons to select **Parental**, then press the **▶** or **ENTER** button.

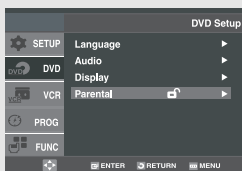

4

Press the **▶** or **ENTER** button to select **Yes** if you want to use a password. The Enter Password screen appears.

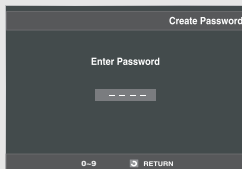

5

Enter your password. The Re-enter Password screen appears to confirm the password. Enter your password again.

The player is locked (🔒).

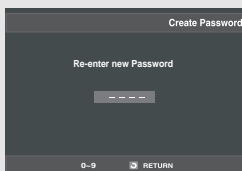

◀ - To make the DVD Setup menu disappear, press the MENU button.

Note

There is no default password.

DVD OPERATIONS

Setting Up the Rating Level

1

With the unit in stop mode, press the **MENU** button on the remote control.

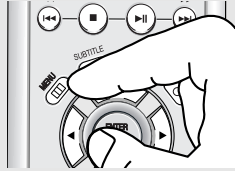

2

Press the **▲/▼** buttons to select **DVD**, then press the **▶** or **ENTER** button.



3

Press the **▲/▼** buttons to select **Parental**, then press the **▶** or **ENTER** button.

Enter your password.

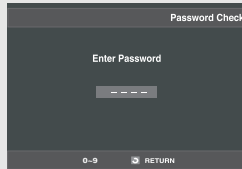

4

Press the **▲/▼** buttons to select **Rating Level**, then press the **▶** or **ENTER** button.

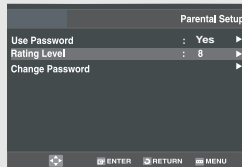

5

Press the **▲/▼** buttons to select the Rating Level you want, then press the **▶** or **ENTER** button.

e.g) Setting up in Level 6.



- ◀ - To make the DVD setup menu disappear, press the MENU button.
- For example, if you select up to Level 6, discs that contain Level 7, 8 will not play.

DVD OPERATIONS

Changing the Password

1

With the unit in stop mode, press the **MENU** button on the remote control.

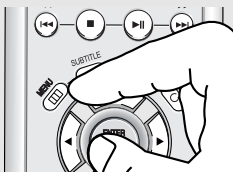

2

Press the ▲/▼ buttons to select **DVD**, then press the ► or **ENTER** button.

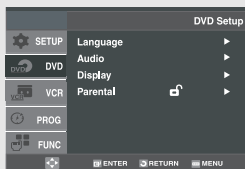

3

Press the ▲/▼ buttons to select **Parental**, then press the ► or **ENTER** button.

Enter your password.

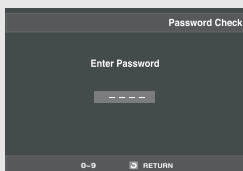

4

Press the ▲/▼ buttons to select **Change Password**, then press the ► or **ENTER** button.

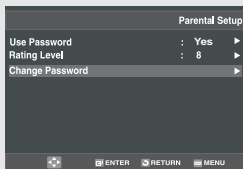

5

Enter your new password.
Re-enter the new password again.

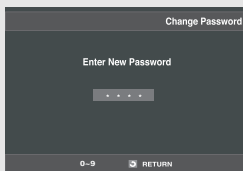

◀ - To make the DVD setup menu disappear, press the MENU button.

Note

If you forgot your password, press power on from a cold start with no disc in the unit. Press the ◀/▶ (Skip) buttons simultaneously on the front panel for 5 seconds. The "Reset Ok" message will appear. Press the **POWER** button.

Chapter 5

VCR OPERATIONS

In this chapter, you will learn how to play a video cassette tape, how to use the time counter and memory stop features, and how to record a program as you are watching TV.

Inserting and Ejecting a Video Cassette Tape

To Insert a Video Cassette Tape

1

Hold the video cassette tape window-side up with the arrow pointing away from you.

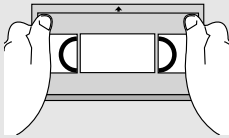

2

Gently push the tape through the compartment door until you feel the VCR pull it.

The VCR loads the tape automatically.

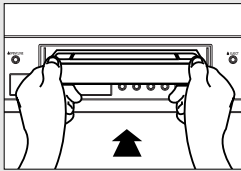

- ◀ - Don't try to insert a tape upside down or backwards.
- Use only video tapes labeled "VHS." European PAL VHS video tapes and S-VHS pre-recorded tapes aren't compatible with this unit. Choose brand name, high quality tapes for best results.
- ◀ - If the safety tab of your video tape has been removed, the tape begins to play automatically. You don't have to press PLAY. For more information on the safety tab, see page 75.

To Eject a Video Cassette Tape

1

Press the ■ (Stop) button to stop playing the tape.

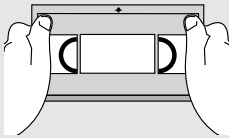

2

Press the **EJECT** button on the front panel to eject the tape.

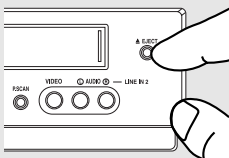

- ◀ When you're finished playing a pre-recorded video tape, it's best to rewind it to the beginning and remove it from the VCR to protect it from wear and tear.
- ◀ After ejecting a tape, you should remove it completely from the compartment and turn off the VCR.

Playing a Pre-Recorded Video Cassette Tape

Playing the Tape

1

Insert the video cassette tape.

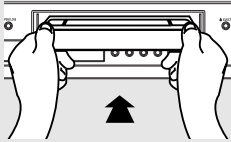

◀ - For more information on the safety tab, see page 75.

2

If the tape doesn't begin to play automatically, press the ►|| (Play/Pause) button.

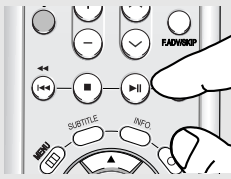

3

Pausing Play

While a tape is playing, press the ►|| (Play/Pause) button when you want to interrupt play. The tape pauses temporarily.

Press the ►|| (Play/Pause) button to resume playing the tape.

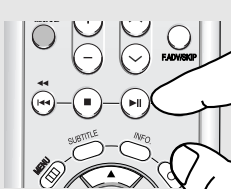

◀ - The VCR does not play sound while a video tape is paused.

- If you see white lines on the screen, see "Using Automatic Tracking" on page 66.

Special VCR Playback Features

While a videotape is playing, you can enjoy a variety of special playback features, including Still, Frame Advance, Skip, Repeat, and more. Press the Play/Pause button again to resume normal playback.

Frame Advance

In the pause mode, press **F.ADV** to advance to the next frame.

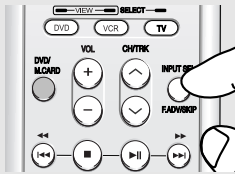

Fps/Rps Review

In Play mode, press the **>>>** (Forward) or **<<<** (Rewind) to review at two speeds:

- Picture Search: Press and release to advance the tape forward or backward at 5 times normal speed.
- Jet Search: Press and hold down the **SEARCH** button, then release it to play back at the normal speed.

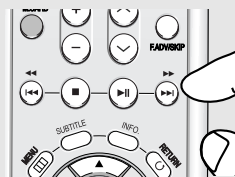

Skip

In Play mode, press the **SKIP** button to move ahead exactly 30 seconds. Press the **SKIP** button repeatedly up to 4 times to move ahead 2 minutes.

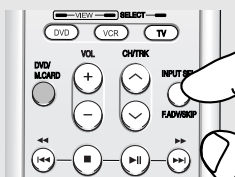

Repeat

- In Play mode, press the **REPEAT** button to review the last 5 seconds of tape (SP mode).
- In Play mode, press the **REPEAT** button to review the last 15 seconds of tape (SLP mode).

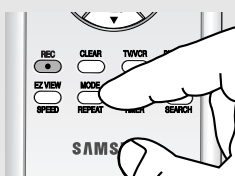

VCR OPERATIONS

Shuttle

In Play mode, **Shuttle >>** gradually increases the cue speed: Double Speed playback → Picture Search → Jet Search.

Shuttle << gradually slows down the tape, then goes into Slow mode, Still mode, Reverse Picture Search and Reverse Jet Search.

Each time you press the **SHUTTLE** button, the playback speed is different accordingly.



Using Automatic Tracking

The Tracking adjustment removes the white lines that sometimes appear during playback because of slight differences in recording decks. The TRK button will automatically align the recorded tracks with the playback heads to solve this problem. You may also set tracking manually.

1

Insert and play a video cassette tape.

As soon as the tape begins to play, the VCR begins automatic tracking.

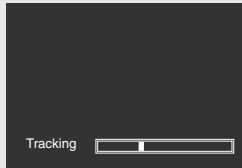

2

If automatic tracking doesn't remove the streaks from the picture, press and hold the TRK (↔) or TRK (☑) button until the streaks disappear.



Selecting the Cassette Type

If you wish to use the tape counter to display the time remaining on a cassette, you must indicate the type of cassette inserted.

1

Press the **MENU** button on the remote control.

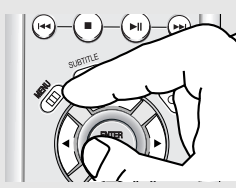

2

Press the **▲/▼** buttons to select **VCR**, then press the **▶** or **ENTER** button.



3

Press the **▲/▼** buttons to select **Tape Length**, then press the **▶** or **ENTER** button to select the correct cassette length.

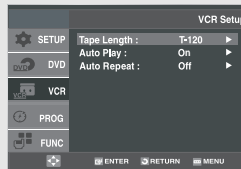

Note

This information is usually printed on the tape box. The menu cycles through: T-120, T-160 or T-180.

Once the type of cassette is set, the VCR can display the amount of time remaining on the tape when you press the INFO. button.

4

Press the **MENU** button to exit.

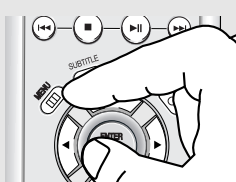

Setting the Auto Play

If you want your videotapes to play automatically when you insert them, turn on Auto Play.

1

Press the **MENU** button on the remote control.

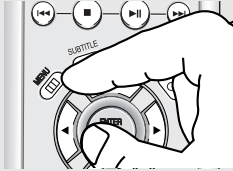

Note

Only tapes that are missing the Record Safety Tab will play automatically when inserted (See page 75).

2

Press the ▲/▼ buttons to select **VCR**, then press the ► or **ENTER** button.



3

Press the ▲/▼ buttons to select **Auto Play**, then press the ► or **ENTER** button to select **On** or **Off**.



- ◀ - On: The VCR will automatically begin playing a video tape when it is inserted, as long as the safety tab of the cassette has been removed.
- Off: Auto play is disabled.

4

Press the **MENU** button to exit.

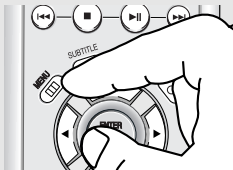

Setting the Auto Repeat

If you want your videotapes to play repeatedly, turn on Auto Repeat.

1

Press the **MENU** button on the remote control.

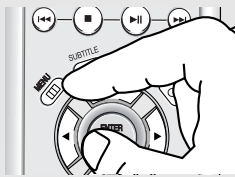

2

Press the ▲/▼ buttons to select **VCR**, then press the ► or **ENTER** button.



3

Press the ▲/▼ buttons to select **Auto Repeat**, then press the ► or **ENTER** button to select **On** or **Off**.



- ◀ - On: The VCR will play a tape repeatedly [unless a tape control is activated (stop, fast forward or rewind)].
- Off: Auto Repeat is disabled.

4

Press the **MENU** button to exit.

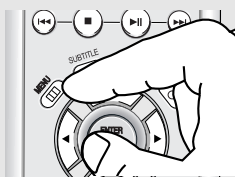

Using the Tape Counter

The tape counter:

- Indicates the elapsed time in the play and record modes (hours, minutes and seconds).
- Is reset when a cassette is inserted in the DVD-VCR.
- Allows you to easily find the beginning of a sequence.
- If the remaining time is to be calculated correctly, you must indicate the type of cassette being used.

1

Insert a cassette in your DVD-VCR. To set the tape counter to zero at the beginning of a sequence:

- Press the **INFO.** button twice to display the counter
- Press the **CLEAR** button when you want to set the tape counter to zero.

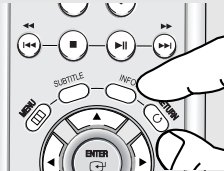

2

When you are ready,

- Start playback or Recording.
- Press the **■** (Stop) button.
- To fast-forward or rewind to the sequence at which the counter was set to zero, press the **▶▶** (Forward) or **◀◀** (Rewind) button.
- Some DVD-VCR information, such as the counter, can be displayed on the television screen.

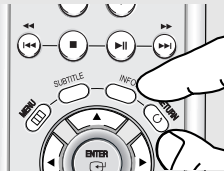

Press the **INFO.** button:

- Once to display the current function, recording speed and counter.
- Twice to display the counter only.
- Three times to display the time remaining on the cassette.
- Four times to clear the display.

Using the Assemble Edit Function

This function allows you to start a new recording at a specific position on the cassette while maintaining a very smooth scene change.

1

Insert the cassette to be edited in your DVD-VCR.

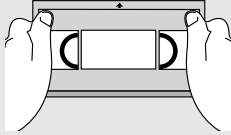

2

Press the ►|| (Play/Pause) button to start playback.



3

When you reach the position from which you wish to start the new recording, press the ►|| (Play/Pause) button.



4

Press the **F.ADV** button as often as necessary to advance the frame by frame, until the exact recording position is located.



5

While the DVD-VCR is in pause mode, press the **REC** button. The pause mode is displayed on the screen.

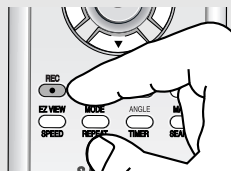

VCR OPERATIONS

6

Select the source from which you wish to record by pressing:

- The **CH** \wedge or \vee buttons for television channel.
- The **INPUT SEL.** button for the **LINE1** or **LINE2** input source.

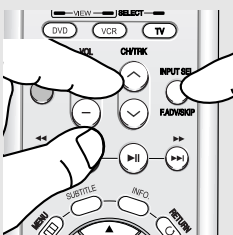

7

Press the **REC** button to start recording. When you have finished recording, press the **■** (Stop) button.

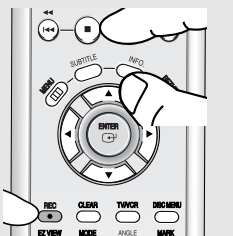

Selecting the Audio Output Mode

You can select the mode in which the sound is reproduced on the loudspeakers and AV outputs. The following options are available.

Press the **AUDIO** button on the remote control until the required option is displayed.



Audio output mode

- Left: Used to listen to the sound on the left Hi-Fi channel.
- Right: Used to listen to the sound on the right Hi-Fi channel.
- Mono: Used to listen to the sound on the normal mono channel.
- Hi-Fi: Used to listen to Hi-Fi stereo sound on the left and right channels. When playing back tapes recorded in Hi-Fi, the sound switches to Hi-Fi after five seconds of Mono.

Searching for a Specific Sequence

Each time you record a cassette on this DVD-VCR, an “index” is automatically marked on the tape when recording starts.

The Search function allows you to fast-forward or rewind to a specific index and start playback from that point. Depending on the direction selected, the indexes are numbered as follows:

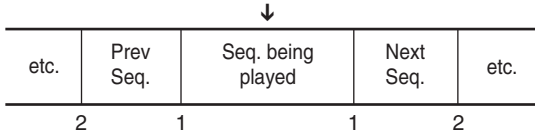

This DVD-VCR uses a standard indexing system (VISS). As a result, it will recognize any indexes marked by other VCRs using the same system and vice versa.

1

Press the **MENU** button on the remote control.

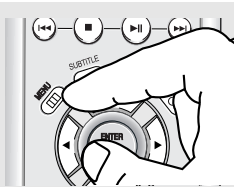

2

Press the ▲/▼ buttons to select **Function**, then press the ► or **ENTER** button.

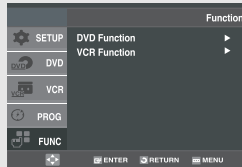

3

Press the ▲/▼ buttons to select **VCR Function**, then press the ► or **ENTER** button.

VCR Function can be displayed simply by pressing the **SEARCH** button.

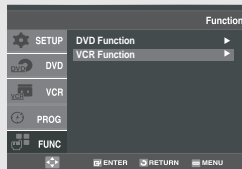

4

Press the ▲/▼ buttons to select the desired item, then press the ► or **ENTER** button.

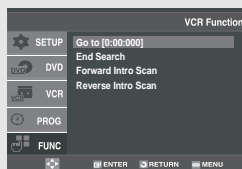

Variable Search System

Go To [0:00:00] Stop

Use this feature when you want to search for the 0:00:00 counter position on a cassette.

Press the **CLEAR** button at the point on the tape where you want to set the counter to [0:00:00].

The VCR will rewind or fast forward, searching for the 0:00:00 counter position, and then automatically stop at that position.

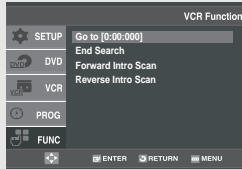

End Search

Use this feature when you want to search for a blank position to record a program on a cassette.

The VCR will fast forward, searching for a blank position, and then automatically stop at that position.

If the VCR reaches the end of the tape during end search, the tape will be ejected.

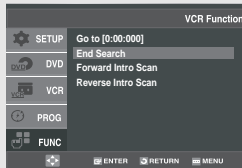

Scan and play

Use scan and play when you don't know exactly where a program is located on a cassette tape.

- **Forward Intro Scan**
Select "Forward Intro Scan", then press the **ENTER** button.
- **Reverse Intro Scan**
Select "Reverse Intro Scan", then press the **ENTER** button.

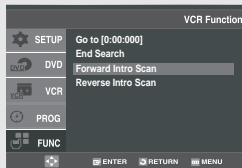

Basic Recording

You can record a TV show in progress by inserting a blank tape and pressing the REC button. You can even add time in 30-minute increments up to 4 hours by pressing the REC button repeatedly; see page 77.

Note

Be sure your videotape has a Record Safety Tab. If the tab is missing, you can cover the opening with a small piece of tape. Warning: Do not cover this opening unless you are sure you want to record over the tape.

Before You Begin...

- Power on the DVD-VCR
- Power on the TV

Protecting a Recorded Cassette

Video cassettes have a safety tab to prevent accidental erasure. When this tab has been removed, you cannot record on the tape.

If you wish to protect a cassette, break off the tab using a small screwdriver.

To re-record over a protected cassette (safety tab broken), cover the hole with adhesive tape.



Recording

1

Insert a blank VHS tape into the VCR deck. Make sure the tape is long enough to record the entire program. Press the SPEED button to set to the record speed. (See page 78)

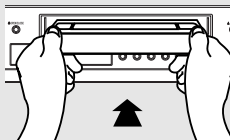

2

Use the Number buttons or the CH ▲ or ▼ buttons to select the desired channel, or press the INPUT SEL. button to select **Line 1** or **2** if recording from an external device connected to the front or rear jacks, respectively.

VCR OPERATIONS

3

Press the **REC** button on the remote control or front panel.

For options while recording is in progress, see "Special Recording Features" on this page.

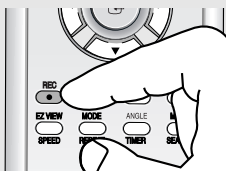

Note

Recording from the DVD-VCR to the VCR is not possible.

4

Pause/Resume Recording

Press the **▶||** (Play/Pause) button.

Press the **REC** button again to resume.



5

Stop Recording

Press the **■** (Stop) button.



Special Recording Features

While a recording is in progress, you can watch a different channel or a DVD, or add recording time in 30-minute increments.

To Watch a different Channel while Recording

Make sure that you connect the DVD-VCR to the TV using an RF cable.

- When you watching through the Antenna input during recording, press the TV/VCR button on the remote control. Using your TV remote control, change the channel you want to watch.
- When you watching through Line input during recording, change the input of your TV from Line to Antenna. Using your TV remote control, change the channel you want to watch.

VCR OPERATIONS

To Watch a DVD while Recording

Insert a DVD in the DVD tray and press the ►|| (Play/Pause). The output will automatically change to the DVD.

To Add Recording Time

See One-Touch Recording (OTR) below.

Using One-Touch Recording

One-Touch Recording (OTR) allows you to add recording time in 30-minute increments up to 4 hours at the touch of a button.

1

Insert a blank VHS tape into the VCR deck.

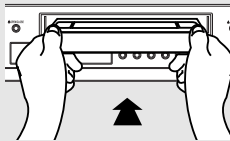

2

Use the Number buttons or the **CH ▲** or **▼** buttons to select the desired channel, or press the **INPUT SEL.** button to select **Line 1** or **2** if recording from an external device connected to the front or rear jacks, respectively.

3

Press the **REC** button on the remote control or front panel.

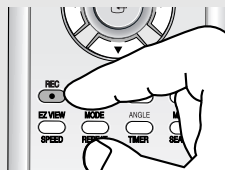

VCR OPERATIONS

4

While in Record mode, press the **REC** button again to activate One-Touch Recording (OTR).

Record length 0:30 appears on the On-screen display and the DVD-VCR will record for exactly 30 minutes.

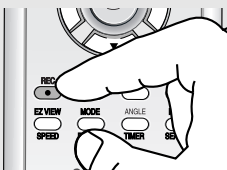

5

Add Recording Time

Continue pressing **REC** button to add recording time in 30 minute increments up to 4 hours.

The DVD-VCR stops recording automatically when the time has elapsed. The DVD-VCR will automatically be turned off when the OTR finished.

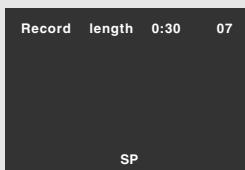

Selecting the Recording Speed

You can slow down the recording speed from SP to SLP in order to fit six hours of programming on a T-120 tape.

Press the **SPEED** button on the remote control to select the Record Speed.

- SP: Standard Play, for best quality.
- SLP: Super Long Play, for maximum recording time (3 times SP).

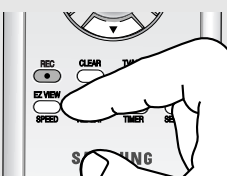

Note

The selected Record Speed will appear on the front panel display and on-screen display.

Maximum Recording Time - SP vs. SLP

| Tape Length | SP (Standard Play) | SLP (Super Long Play) |
|-------------|--------------------|-----------------------|
| T-120 | 2 hrs | 6 hrs |
| T-160 | 2hrs 40 mins | 8 hrs |
| T-180 | 3 hrs | 9 hrs |

Using a Timer Recording

Insert a blank videotape into the VCR deck. Be sure to leave the Record Safety Tab intact. With the Timer Recording function, you can program up to 7 events at a time to record up to a month in advance.

To Begin Setting the Timer Recording,

- Power On your DVD-VCR.
- Power On your TV.

1

Press the **MENU** button on the remote control.

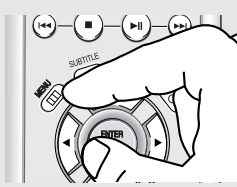

2

Press the ▲/▼ buttons to select **PROG**, then press the ► or **ENTER** button.

It can be displayed simply by pressing the **TIMER** button.

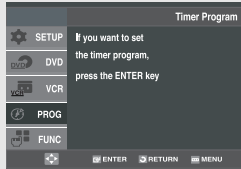

3

Select Channel Number

Press the ► button, then press the ▲/▼ buttons to set the channel.

Press the ► button to move to the next setting.

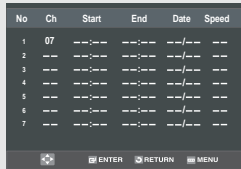

4

Set Time/Date/Speed

Repeat Step 3 above to set start time, end time, date and record speed.

Date can be set for one time, daily or weekly recording.

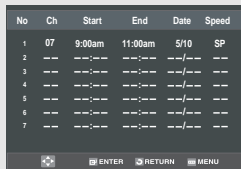

Note

You can select external input directly (L1 or L2) using INPUT SEL. button.

VCR OPERATIONS

Selecting Auto Speed

If the length of the videotape is not long enough for a timer recording in the SP mode, set the recording tape speed to "Auto". Recording will start in the SP mode. If the length is not long enough, the tape speed will automatically change from SP mode to SLP mode.

Daily/Weekly Date Programming

Weekly [sun's~sat's]: Use this to record TV programs on the same channel at the same time every week. Daily [MO - FR] : Use this to record TV programs on the same channel at the same time every day Monday through Friday.

5

Save Timer Recording

Press the **RETURN** button to finish setting the timer recording.

Stop the DVD-VCR or turn the power off. Then the DVD-VCR will automatically turn on and begin recording at the time you set.

To stop the timer recording, press the **POWER** button or press the **■** (Stop) button twice.

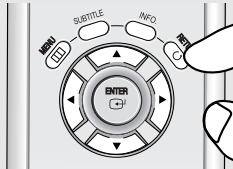

Chapter 6

REFERENCE

Using the TV Buttons on the Remote Control

Your DVD-VCR remote control will work with Samsung televisions and compatible brands.

To determine whether your television is compatible, follow the instructions below.

- 1 Switch your television on.
- 2 Point the remote control towards the television.
- 3 Hold down the TV button and enter the two-figure code corresponding to the brand of your television, by pressing the appropriate numeric buttons.

| TV Codes | |
|------------|----------------|
| BRAND | CODE |
| SAMSUNG | 01, 14, 15, 23 |
| DAEWOO | 19 |
| EMERSON | 21 |
| HITACHI | 10 |
| LG | 06, 08, 18 |
| LOEWE | 28 |
| MAGNAVOX | 04 |
| NEWSAN | 27 |
| NOBLEX | 25 |
| PANASONIC | 12, 24 |
| RCA | 07, 29 |
| SANYO | 05, 20 |
| SHARP | 02, 16, 22 |
| SONY | 03 |
| TELEFUNKEN | 26 |
| TOSHIBA | 09 |
| ZENITH | 17 |

Note

- If your television is compatible with the remote control, it will switch off. It is now programmed to operate with the remote control.
- If several codes are indicated for your television brand, try each one in turn until you find one that works.

You can then control the television using the following buttons.

| Button | Function |
|---------------|--|
| POWER | Used to switch the television on and off. |
| INPUT SEL. | Used to select an external source. |
| VOL + or - | Used to adjust the volume of the television. |
| CH (^ or v) | Used to select the required channel. |
| TV MUTE | Used to toggle the sound on and off. |

The various functions will not necessarily work on all televisions. If you encounter problems, operate the television directly.

Troubleshooting

Before contacting a Samsung authorized service center, perform the following simple checks.

If you are unable to solve the problem after reading the above instructions, note:

- The model and serial number on the rear of your DVD-VCR
- The warranty information
- A clear description of the problem

Then contact your nearest SAMSUNG service center.

Identifying DVD Problems

| Problem | Action | Page |
|---|---|--------|
| No operations can be performed with the remote control. | <ul style="list-style-type: none"> • Check the batteries in the remote control. They may need replacing. • Operate the remote control at a distance of no more than 20 feet. • Remove batteries and hold down one or more buttons for several minutes to drain the microprocessor inside the remote control to reset it. Reinstall batteries and try to operate the remote control again. | P3 |
| Disc does not play. | <ul style="list-style-type: none"> • Ensure that the disc is installed with the label side facing up. • Check the region number of the DVD. | P7 |
| 5.1 channel sound is not being reproduced. | <ul style="list-style-type: none"> • 5.1 channel sound is reproduced only when the following conditions are met: <ol style="list-style-type: none"> 1) The DVD-VCR is connected with the proper Amplifier 2) The disc is recorded with 5.1 channel sound. • Check whether the disc being played has the "5.1 ch" mark on the outside. • Check if your audio system is connected and working properly. • In a DVD Setup Menu, is the Audio Output set to Bitstream? | P18 |
| The  icon appears on screen. | <ul style="list-style-type: none"> • The features or action cannot be completed at this time because: <ol style="list-style-type: none"> 1. The DVD's software restricts it. 2. The DVD's software doesn't support the feature (e.g., angles). 3. The feature is not available at the moment. 4. You've requested a title or chapter number or search time that is out of range. | - |
| Disc Menu doesn't appear. | <ul style="list-style-type: none"> • Check if the disc has a Menu. | - |
| Play mode differs from the Setup Menu selection. | <ul style="list-style-type: none"> • Some of the functions selected in the Setup Menu may not work properly if the disc is not encoded with the corresponding function. | - |
| The screen ratio cannot be changed. | <ul style="list-style-type: none"> • The Screen Ratio is fixed on your DVDs. | P40~41 |
| No audio. | <ul style="list-style-type: none"> • Make sure you have selected the correct Digital Output in the Audio Options Menu. | P56~57 |

| |
|-----------|
| REFERENCE |
|-----------|

| Problem | Action | Page |
|-----------------------------------|---|--------|
| The screen is blocked | <ul style="list-style-type: none"> Press the ◀▶ buttons simultaneously for more than 5 seconds with no disc in the unit. All settings will revert to the factory settings. | - |
| Forgot password | <ul style="list-style-type: none"> Press the ◀▶ buttons simultaneously for more than 5 seconds with no disc in the unit. All settings including the password will revert to the factory settings. Don't use this unless absolutely necessary. | P60-62 |
| If you experience other problems. | <ul style="list-style-type: none"> Go to the contents and find the section of the instruction book that contains the explanations regarding the current problem, and follow the procedure once again. If the problem still cannot be solved, please contact your nearest authorised service center. | |
| The picture is noisy or distorted | <ul style="list-style-type: none"> Make sure that the disc is not dirty or scratched. Clean the disc. | |

Identifying VCR Problems

| Problem | Action | Page |
|--|---|--------|
| No power | <ul style="list-style-type: none"> Check that the power plug is connected to a wall outlet. | - |
| You cannot insert a video cassette | <ul style="list-style-type: none"> A video cassette can only be inserted with the window side up and the safety tab facing you. | P63 |
| The television program was not recorded | <ul style="list-style-type: none"> Check the DVD-VCR antenna/cable connections. Is the DVD-VCR tuner properly set? Check if the safety tab is intact on the cassette. | - |
| Timer recording was unsuccessful | <ul style="list-style-type: none"> Re-check the recording start/stop time settings. If there was a power failure or interruption during timer recording, the recording will have been cancelled. | P79-80 |
| No playback picture or the picture is distorted | <ul style="list-style-type: none"> Check to see if you are using a prerecorded tape. | P75 |
| You cannot see normal broadcasts | <ul style="list-style-type: none"> Check the tuner or external setting. It should be on tuner. Check the TV or VCR antenna connections. | - |
| Noise bars or streaks on playback | <ul style="list-style-type: none"> Press the TRK buttons to minimize this effect. | P66 |
| When the ▶/ll button is pressed during playback, the still picture has severe "noise bars" streaks | <ul style="list-style-type: none"> A still picture may have "noise bars", depending on the condition of the tape. Press the TRK buttons during slow motion to minimize this effect. | - |
| Video Head Cleaning | <ul style="list-style-type: none"> If poor pictures appear on a variety of cassettes, the video heads may need cleaning. This is not a common problem and unless it appears, the heads should not be cleaned. When cleaning the video heads, read all instructions provided with the head cleaning cassette. Incorrect head cleaning can permanently damage the video heads. | - |

Technical Specifications

| | | |
|----------------|--------------------|--|
| Inputs | AUDIO | 2 Stereo audio inputs, RCA Connector, -8dbm, 47K Ω , front and rear |
| | VIDEO | 2 Composite video inputs, RCA Connector, 75 Ω , 1Vp-p |
| | RF | Antenna or CATV Input, F-Connector, 75 Ω |
| Outputs | AUDIO | 1 Stereo audio outputs, RCA Connector, -8dbm, 1.5K Ω |
| | AUDIO (DVD only) | 1 Digital audio output (1 coaxial) 1 pair Stereo audio outputs |
| | VIDEO | 1 Composite video output, RCA Connector, 75 Ω , 1Vp-p |
| | VIDEO (DVD only) | 1 S-Video output, S-Connector, 75 Ω , Y=1.0Vp-p, C=0.286Vp-p 1 Component video output, 75 Ω , Y=1.0Vp-p, Pb=0.7Vp-p, Pr=0.7Vp-p |
| VCR | RF | Channel 3 or 4 |
| | VIDEO SYSTEM | 1/2-inch VHS system, 4 rotary head helical scanning; FM azimuth luminance;chrominance: converted sub system phase shift |
| | AUDIO TRACK | Normal: 1 track; Hi-Fi: 2 track |
| | PLAY/RECORD TIME | T-180 tape: SP 3 hours, SLP 9 hours |
| | FF/REW TIME | T-120 tape: <2 minutes |
| | HEADS | Video: DA 4 rotary Audio: 2 rotary heads (Hi-Fi); 1 stationary head (Linear) Control: 1 stationary head Erase: 1 full track, 1 audio track |
| | WOW & FLUTTER | Less than 0.005% (Hi-Fi) |
| | FREQ. RESPONSE | 20-20,000 Hz (Hi-Fi) |
| DVD | DISC COMPATIBILITY | CD, CD-R, CD-RW DVD-Video, CD-Digital Audio (5" and 3.5") |
| | FREQ. RESPONSE | 96/48 kHz Sampling: 4 Hz-22kHz |
| | S/N RATIO | 110 dB |
| | DYNAMIC RANGE | 96 dB |
| | THD | 0.003 % |
| SYSTEM | POWER REQUIREMENT | 120V AC, 60 Hz, 25 watts |
| | ENVIRONMENT | 41-104°F (5-40°C); 10%-75% humidity |
| | WEIGHT | 13.8 lbs. |

- Samsung Electronics Co., Ltd reserves the right to change the specifications with out notice.
- Weight and dimensions are approximate.

MEMO

Warranty

LIMITED WARRANTY TO ORIGINAL PURCHASER

THIS SAMSUNG BRAND PRODUCT, AS SUPPLIED AND DISTRIBUTED BY SAMSUNG ELECTRONICS AMERICA, INC. (SAMSUNG) AND DELIVERED NEW, IN THE ORIGINAL CARTON TO THE ORIGINAL CONSUMER PURCHASER, IS WARRANTED BY SAMSUNG AGAINST MANUFACTURING DEFECTS IN MATERIALS AND WORKMANSHIP FOR THE FOLLOWING LIMITED WARRANTY PERIOD:

One (1) Year Parts / Ninety (90) days Labor

This limited warranty begins on the original date of purchase, and is valid only on products purchased and used in the United States, and does not include transportation, installation, removal or reinstallation. WARRANTY REPAIRS MUST BE PERFORMED BY SAMSUNG'S AUTHORIZED SERVICE CENTER. TO RECEIVE WARRANTY SERVICE, THE ORIGINAL DATED BILL OF SALE MUST BE PRESENTED UPON REQUEST AS PROOF OF PURCHASE TO SAMSUNG OR SAMSUNG'S AUTHORIZED SERVICE CENTER. TRANSPORTATION TO AND FROM THE SERVICE CENTER IS THE RESPONSIBILITY OF THE PURCHASER.

SAMSUNG WILL REPAIR OR REPLACE THIS PRODUCT, AT OUR OPTION AND AT NO CHARGE WITH NEW OR RECONDITIONED PARTS, IF FOUND TO BE DEFECTIVE DURING THE LIMITED WARRANTY PERIOD SPECIFIED ABOVE. The product must be returned during the warranty period with transportation charges prepaid to SAMSUNG's designated service center. Prior to returning any product for warranty service, the purchaser must contact SAMSUNG for problem determination and service procedures. SAMSUNG DOES NOT WARRANT UNINTERRUPTED OR ERROR-FREE OPERATION OF THE PRODUCT. All replaced parts and products become the property of SAMSUNG and must be returned to SAMSUNG. Replacement parts and products assume the remaining original warranty, or ninety (90) days, whichever is longer.

This limited warranty covers manufacturing defects in materials and workmanship encountered in normal, noncommercial use of this product and shall not apply to the following, including, but not limited to: damage which occurs in shipment; applications and uses for which this product was not intended; failures or problems which are caused by products or equipment not supplied by SAMSUNG; accidents, misuse, abuse, neglect, misapplication, fire, water, lightning or other acts of nature; incorrect electrical line voltage, fluctuations or surges; damage caused by improper or faulty installation; improper connection with any peripheral; product alteration or modification; improper or unauthorized repair; cosmetic damage or exterior finish; product with altered serial numbers; failure to follow operating instructions, customer adjustments, maintenance and environmental instructions that are covered and prescribed in the instruction book; use of non-SAMSUNG or unauthorized parts, supplies, accessories or equipment which damage this product or result in service problems; failures or problems due to incompatibility with other equipment.



ELECTRONICS

HEADQUARTERS
105 Challenger Road
Ridgefield Park, NJ 07660-0511
TEL: 1-800-SAMSUNG

SERVICE DIVISION
400 Valley Road, Suite 201
Mount Arlington, NJ 07856
1-800-SAMSUNG (1-800-726-7864)
www.samsung.com