

SAMSUNG

DVD Player

DVD-P250K

DVD-P255K

DVD-P256K



Precautions

1. Setting up

- Refer to the identification label located on the rear of your player for its proper operating voltage.
- Install your player in a cabinet with adequate ventilation holes. (7~10cm) Do not block ventilation holes on any of the components for air circulation.
- Do not push the disc tray in by hand.
- Do not stack components.
- Be sure to turn all components off before moving the player.
- Before connecting other components to this player, be sure to turn them off.
- Be sure to remove the disc and turn off the player after use, especially if you don't use it for a long time.

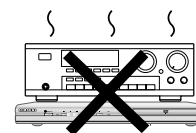
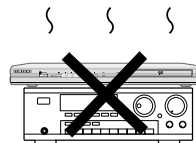
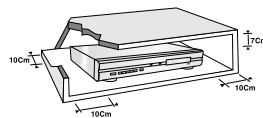

2. For your safety

- This product utilizes a laser. Use of controls or adjustments or performance of procedures other than those specified herein may result in hazardous radiation exposure.
- Do not open covers and do not repair yourself. Refer servicing to qualified personal.

CAUTION	LASER RADIATION WHEN OPEN DO NOT STARE INTO BEAM
ATTENTION	RAYONNEMENT LASER EN CAS D'OUVERTURE. NE PAS REGARDER DANS LE FASCEAU.
VORSICHT	LASERSTRALUNG, WENN ABDECKUNG GEOFFNET, NICHT IN DEN STRAHL BLICKEN.
ADVARSEL	LASERSTRÅLING VED ÅBNING. SE IKKE IND I STRÅLEN.
WARNING	LASERSTRÅLING NÄR DENNA DEL ÄR ÖPPNAD. STIRRA EJ IN STRÅLEN.
VARO!	AVANTAGESI OLET ÄLTYMÄ LASERSÄTELYLLE, ÄLÄ TULIOTA SÄTEESEEN.
WAARSCHYING	LASERSTRALING INDIEN GEOPEND. NIJK NIET IN DE STRAAL.

CLASS 1
LASER PRODUCT

3. Caution

- Your player is not intended for industrial use but for domestic purposes. Use of this product is for personal use only.
- Do not put any container filled with liquid or any small metal objects on the player.
- Exterior influences such as lightning and static electricity can affect normal operation of this player. If this occurs, turn the player off and on again with the POWER button, or disconnect and then reconnect the AC power cord to the AC power outlet. The player will operate normally.
- When condensation forms inside the player due to sharp changes in temperature, the player may not operate correctly. If this occurs, leave the player at room temperature until the inside of the player becomes dry and operational.

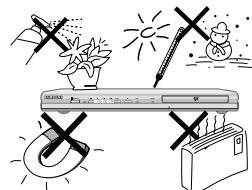

4. Disc

- Do not clean record-cleaning sprays, benzene, thinner, or other volatile solvents that may cause damage to the disc surface.
- Do not touch the disc's signal surface. Hold by the edges or by one edge and the hole in the center.
- Wipe the dirt away gently; never wipe a cloth back and forth over the disc.

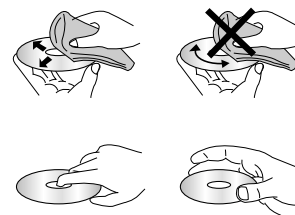

5. Environmental info

- The battery used in this product contains chemicals that are harmful to the environment.
- So, dispose of batteries in the proper manner, according to federal, state, and local regulations.

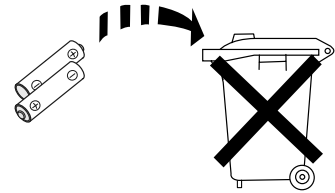

The product unit accompanying this user manual is licensed under certain intellectual property rights of certain third parties. This license is limited to private non-commercial use by end-user consumers for licensed contents. No rights are granted for commercial use. The license does not cover any product unit other than this product unit and the license does not extend to any unlicensed product unit or process conforming to ISO/OUR 11172-3 or ISO/OUR 13818-3 used or sold in combination with this product unit. The license only covers the use of this product unit to encode and/or decode audio files conforming to the ISO/OUR 11172-3 or ISO/OUR 13818-3. No rights are granted under this license for product features or functions that do not conform to the ISO/OUR 11172-3 or ISO/OUR 13818-3.

CAUTION: USE OF ANY CONTROLS, ADJUSTMENTS, OR PROCEDURES OTHER THAN SPECIFIED HEREIN MAY RESULT IN HAZARDOUS RADIATION EXPOSURE.

Before you start

Accessories



Remote Control



Batteries for Remote Control (AAA Size)

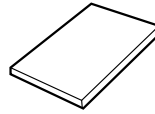

User's Manual

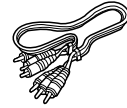

Video/Audio Cable

Install Batteries in the Remote control

1

Open the battery cover on the back of the remote control.

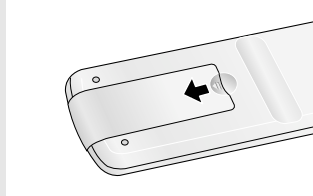

2

Insert two AAA batteries. Make sure that the polarities (+ and -) are aligned correctly.

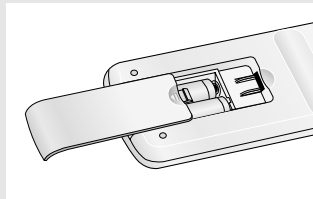

3

Replace the battery cover.

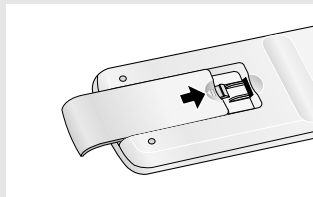

If remote control doesn't operate properly:

- Check the polarity + - of the batteries (Dry-Cell)
- Check if the batteries are drained.
- Check if remote control sensor is blocked by obstacles.
- Check if there is any fluorescent lighting nearby.

TABLE OF CONTENTS

Precautions	2
Before you start	4
Chapter 1: Setup	
General Features	6
Disc Type and Characteristics	7
Description	8
Tour of the Remote Control	10
Chapter 2: Connections	
Choosing a Connection	11
Chapter 3: Basic Functions	
Playing a Disc	17
Using the Search and Skip Functions	19
Using the Display Function	20
Using the Disc and Title Menu	22
Using the Function Menu	23
Repeat Play	24
Slow Repeat Play	25
Program Play & Random Play	26
Chapter 4: Advanced Functions	
Adjusting the Aspect Ratio (EZ View)	27
Selecting the Audio Language	29
Selecting the Subtitle Language	30
Changing the Camera Angle	31
Using the Instant Replay/Skip Function	31
Using the Bookmark Function	32
Using the Zoom Function	34
Clips Menu for MP3/WMA/JPEG	35
MP3/WMA Playback	36
Picture CD Playback	38
Chapter 5: Karaoke Functions	
Karaoke Functions	40
Reserving a Song	41
Vocal Function	42
Chapter 6: Changing Setup Menu	
Using the Setup Menu	43
Setting Up the Language Features	44
Setting Up the Audio Options	48
Setting Up the Display Options	50
Setting Up the Parental Control	52
Chapter 7: Reference	
Troubleshooting	55
Specifications	56

Chapter 1

SETUP

General Features

Excellent Sound

Dolby Digital, a technology developed by Dolby Laboratories, provides crystal clear sound reproduction.

Screen

Both regular and widescreen(16:9) pictures can be viewed.

Slow Motion

An important scene can be viewed in slow motion.

Program Play (CD)

You can program tracks to play in desired order.

Parental Control (DVD)

The parental control allows users to set the level necessary to prohibit children from viewing harmful movies such as those with violence, adult subject matter, etc.

Various On-Screen Menu Functions

You can select various languages (Audio/Subtitle) and screen angles while enjoying movies.

Progressive Scan

Progressive scanning creates an improved picture with double the scan lines of a conventional interlaced picture.

EZ VIEW (DVD)

Easy View enables picture adjustment to match your TV's screen size (16:9 or 4:3).

Digital Photo Viewer (JPEG)

You can view Digital Photos on your TV.

Repeat

You can repeat a song or movie simply by pressing the REPEAT button.

MP3/WMA

This unit can play discs created from MP3/WMA files.

Instant Replay (DVD)

This function is used to replay the previous 10 seconds of a movie from the current position.

Instant Skip (DVD)

This function skips playback ahead 10 seconds.

Note

- Discs which cannot be played with this player.
- DVD-ROM • DVD-RAM
- CD-ROM • CDV
- CDI • CVD
- CDGs play audio only, not graphics.
- Ability to play back may depend on recording conditions.
- DVD-R, +R
- CD-RW
- DVD+RW, -RW (V mode)
- The unit may not play certain CD-R, CD-RW and DVD-R due to the disc type or recording conditions.

COPY PROTECTION

Many DVD discs are encoded with copy protection. Because of this, you should only connect your DVD player directly to your TV, not to a VCR. Connecting to a VCR results in a distorted picture from copy-protected DVD discs.

This product incorporates copyright protection technology that is protected by methods claims of certain U.S. patents and other intellectual property rights owned by Macrovision Corporation and other rights owners. Use of this copyright protection technology must be authorized by Macrovision Corporation, and is intended for home and other limited viewing uses only unless otherwise authorized by Macrovision Corporation. Reverse engineering or disassembly is prohibited.



PROGRESSIVE SCAN OUTPUTS (525p/625p)

"CONSUMERS SHOULD NOTE THAT NOT ALL HIGH DEFINITION TELEVISION SETS ARE FULLY COMPATIBLE WITH THIS PRODUCT AND MAY CAUSE ARTIFACTS TO BE DISPLAYED IN THE PICTURE, IN CASE OF 525 OR 625 PROGRESSIVE SCAN PICTURE PROBLEMS, IT IS RECOMMENDED THAT THE USER SWITCH THE CONNECTION TO THE 'STANDARD DEFINITION' OUTPUT. IF THERE ARE QUESTIONS REGARDING YOUR TV SET COMPATIBILITY WITH THIS MODEL 525p AND 625p DVD PLAYER, PLEASE CONTACT SAMSUNG'S CUSTOMER SERVICE CENTER."





SETUP

Disc Type and Characteristics

This DVD player is capable of playing the following types of discs with the corresponding logos:

Disc Types (Logos)	Recording Types	Disc Size	Max. Playing Time	Characteristics
DVD 	Audio + Video	12 Cm	Single-sided 240 min. Double-sided 480 min.	<ul style="list-style-type: none"> - DVD contains excellent sound and video due to Dolby Digital and MPEG-2 system. - Various screen and audio functions can be easily selected through the on-screen menu.
		8 Cm	Single-sided 80 min. Double-sided 160 min.	
VIDEO-CD 	Audio + Video	12 Cm	74 min.	<ul style="list-style-type: none"> - Video with CD sound, VHS quality & MPEG-1 compression technology.
		8 Cm	20 min.	
AUDIO-CD 	Audio	12 Cm	74 min.	<ul style="list-style-type: none"> - CD is recorded as a Digital Signal with better audio quality, less distortion and less deterioration of audio quality over time.
		8 Cm	20 min.	

Disc Markings

	Play Region Number
PAL	PAL broadcast system in U.K, France, Germany, etc.
	Dolby Digital disc
STEREO	Stereo disc
DIGITAL SOUND	Digital Audio disc
	DTS disc
	MP3 disc

You must only insert one DVD disc at a time. Inserting two or more discs will not allow to play them back and it may cause damage to the DVD player.

Region Number

Both the DVD player and the discs are coded by region. These regional codes must match in order for the disc to play. If the codes do not match, the disc will not play.

The Region Number for this player is described on the rear panel of the player.

SETUP

Description

Front Panel Controls

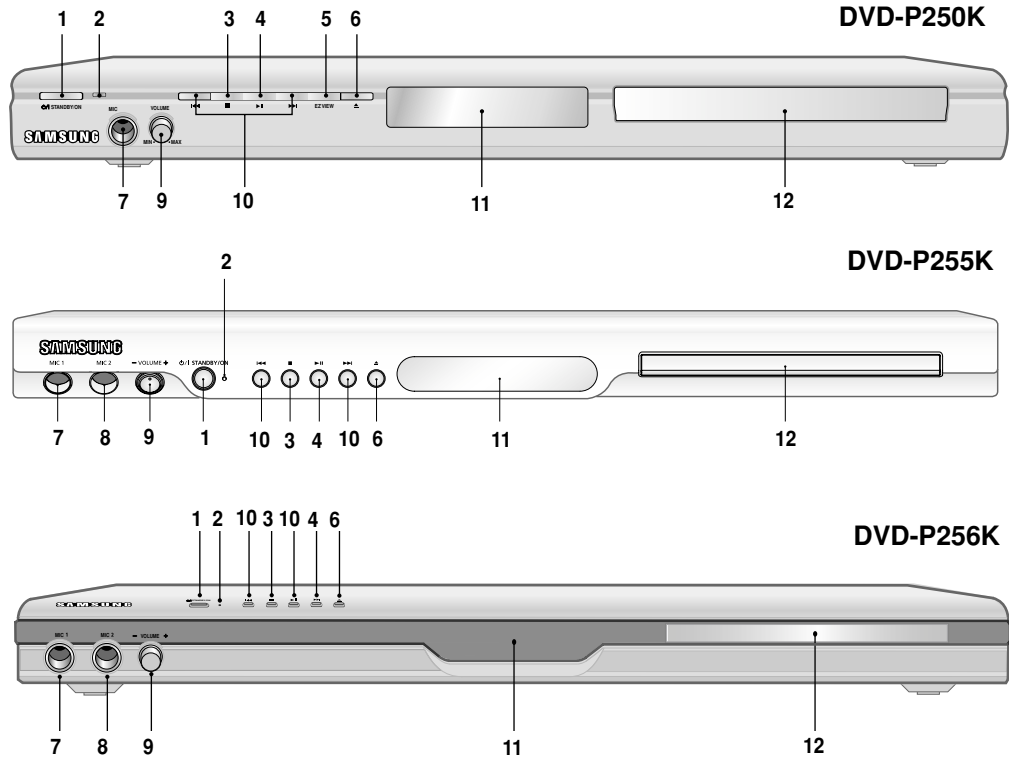

- 1. STANDBY/ON (⏻/⏻)**
When STANDBY/ON is pressed on, the indicator goes out and the player is turned on.
- 2. STANDBY indicator**
When the unit is first plugged in, this indicator lights.
- 3. STOP (■)**
Stops disc play.
- 4. PLAY/PAUSE (▶▶/▶▶)**
Begin or pause disc play.
- 5. EZ VIEW**
The aspect ratio of a picture can easily be adjusted to your TV's screen size (16:9 or 4:3).
- 6. OPEN/CLOSE (▲)**
Press to open and close the disc tray.

- 7. MIC 1**
Connect Microphone 1 for karaoke functions.
- 8. MIC 2**
Connect Microphone 2 for karaoke functions
- 9. MICROPHONE VOLUME**
Use to adjust microphone volume level. Use the button by pressing it. Turn it to the left or right to control the volume.
- 10. SKIP (◀◀/▶▶) SEARCH**
Allow you to search forward/backward through a disc. Use to skip the title, chapter or track.
- 11. DISPLAY**
Operation indicators are displayed here.
- 12. DISC TRAY**
Place the disc here.

Front Panel Display

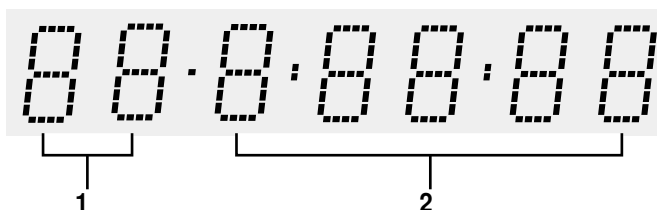

1. **Chapter/Track number indicator**
2. **Total playing time/Displays various messages concerning operations such as PLAY, STOP, LOAD ...**

no dISC: No disc loaded.
 OPEn: The disc tray is open.
 LOAd: Player is loading disc information.

Rear Panel

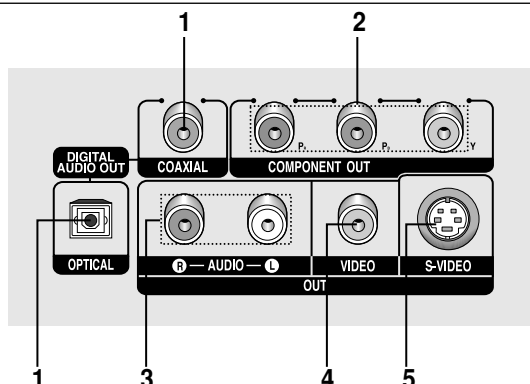

1. DIGITAL AUDIO OUT JACKS

- Use either an optical or coaxial digital cable to connect to a compatible Dolby Digital receiver.
- Use to connect to an A/V Amplifier that contains a Dolby Digital, MPEG2 or DTS decoder.

2. COMPONENT VIDEO OUT JACKS

- Use these jacks if you have a TV with Component Video in jacks. These jacks provide P_R, P_B and Y video.
- If Component(P-SCAN) Video Output is selected in Setup Menu, progressive scan mode will work.
- If Component(I-SCAN) Video Output is selected in Setup Menu, interlaced scan mode will work.

3. AUDIO OUT JACKS

Connect to the Audio input jacks of your television or audio/video receiver.

4. VIDEO OUT JACK

- Use a video cable to connect to the Video input jack on your television.
- The Video Output in Setup Menu must be set to Component(I-SCAN) or S-Video.

5. S-VIDEO OUT JACK

- Use the S-Video cable to connect this jack to the S-Video jack on your television for higher picture quality.
- The Video Output in Setup Menu must be set to S-Video.

Note

- Consult your TV User's Manual to find out if your TV supports Progressive Scan.
 If Progressive Scan is supported, follow the TV User's Manual regarding Progressive Scan settings in the TV's menu system.
- If Component (P-SCAN) Video Output is selected in Setup Menu, Video and S-Video will not work.
- See pages 50 ~ 51 to get more information on how to use the setup menu.

SETUP

Tour of the Remote Control

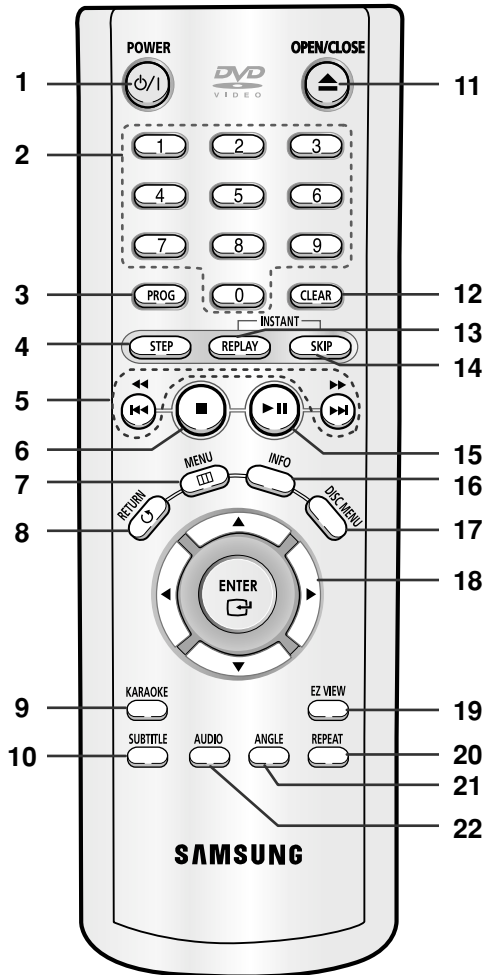

- 1. DVD POWER Button**
Turns the power on or off.
- 2. NUMBER Buttons**
- 3. PROG Button**
Allows you to program a specific order.
- 4. STEP Button**
Advances play one frame at a time.
- 5. SEARCH/SKIP Buttons (◀ / ▶, ◀◀ / ▶▶)**
Allow you to search forward/backward through a disc.
Use to skip the title, chapter or track.
- 6. STOP Button (■)**
- 7. MENU Button**
Brings up the DVD player's menu.
- 8. RETURN Button**
Returns to a previous menu.
- 9. KARAOKE Button**
Use to begin Karaoke functions.
- 10. SUBTITLE Button**
- 11. OPEN/CLOSE (▲) Button**
To open and close the disc tray.
- 12. CLEAR Button**
Use to remove menus or status displays from the screen.
- 13. INSTANT REPLAY Button**
This function is used to replay the previous 10 seconds of a movie from the current position.
- 14. INSTANT SKIP Button**
This function skips playback ahead 10 seconds.
- 15. PLAY/PAUSE Button (▶▶)**
Begin/Pause disc play.
- 16. INFO Button**
Displays the current disc mode.
- 17. DISC MENU Button**
Brings up the Disc menu.
- 18. ENTER/▲/▼,◀/▶ Buttons**
This button functions as a toggle switch.
- 19. EZ VIEW Button**
The aspect ratio of a picture can easily be adjusted according to the screen size of your TV (16:9 or 4:3).
- 20. REPEAT Button**
Allows you to repeat play a title, chapter, track, or disc.
- 21. ANGLE Button**
Use to access various camera angles on a DVD.
- 22. AUDIO Button**
Use this button to access various audio functions on a disc.

Chapter 2

CONNECTION

Choosing a Connection

The following shows examples of connections commonly used to connect the DVD player with a TV and other components.

Before Connecting the DVD Player

- Always turn off the DVD player, TV, and other components before you connect or disconnect any cables.
- Refer to the user's manual of the additional components you are connecting for more information on those particular components.

Connection to a TV (For Video)

1

Using video/audio cables, connect the **VIDEO (yellow)/AUDIO (red and white) OUT** terminals on the rear of the DVD player to the **VIDEO (yellow)/AUDIO (red and white) IN** terminals of TV.

2

Turn on the DVD player and TV.

3

Press the **TV/VIDEO** button on the TV's remote control to select **Video**.

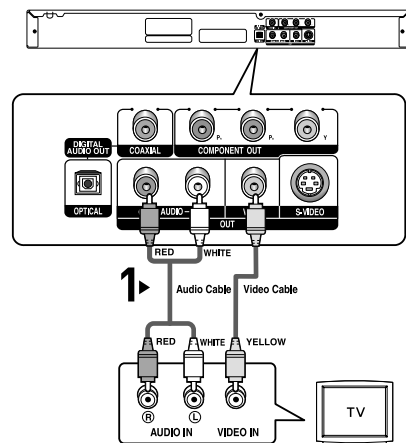

Note

- **Noise may be generated if the audio cable is too close to the power cable.**
- If you want to connect to an Amplifier, please refer to the Amplifier connection page. (See pages 15 to 16)
- The number and position of terminals can vary depending on your TV set. Please refer to the user's manual of the TV.
- If there is one audio input terminal on the TV, connect it to the [AUDIO OUT][left] (white) terminal of the DVD player.

CONNECTION

Connection to a TV (S-Video)

- Connecting to your TV using an S-Video cable.
- You will enjoy high quality images. S-Video separates the picture element into black and white(Y) and color(C) signals to present clearer images than regular video input mode. (Audio signals are delivered through the audio output.)

1

Using an S-Video cable (not included), connect the **S-VIDEO OUT** terminal on the rear of the DVD player to the **S-VIDEO IN** terminal of TV.

2

Using the audio cables, connect the **AUDIO (red and white) OUT** terminals on the rear of the DVD player to the **AUDIO (red and white) IN** terminals of TV. Turn on the DVD player and TV.

3

Press the **TV/VIDEO** button on the TV's remote control to select **S-Video**.

4

Set the Video Output to **S-Video** in the Display Setup menu. (See pages 50 to 51)

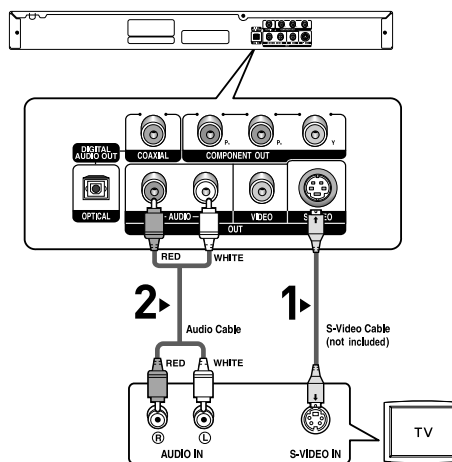

Note

- If you want to connect to an Amplifier, please refer to the Amplifier connection page. (See pages 15 to 16)
- The number and position of terminals can vary depending on the TV set. Please refer to the user's manual of the TV.

CONNECTION

Connection to a TV (Interlace)

- Connecting to your TV using Component video cables.
- You will enjoy high quality and accurate color reproduction images. Component video separates the picture element into black and white(Y), blue(P_B), red(P_R) signals to present clear and clean images. (Audio signals are delivered through the audio output.)

1

Using component video cables (not included), connect the **COMPONENT VIDEO OUT** terminal on the rear of the DVD player to the **COMPONENT IN** terminal of TV.

2

Using the audio cables, connect the **AUDIO (red and white) OUT** terminals on the rear of the DVD player to the **AUDIO (red and white) IN** terminals of TV.
Turn on the DVD player and TV.

3

Press the **TV/VIDEO** button on the TV's remote control to select **Component** or **DVD**.

4

Set the Video Output to **Component (I-SCAN)** in the Display Setup menu. (See pages 50 to 51)

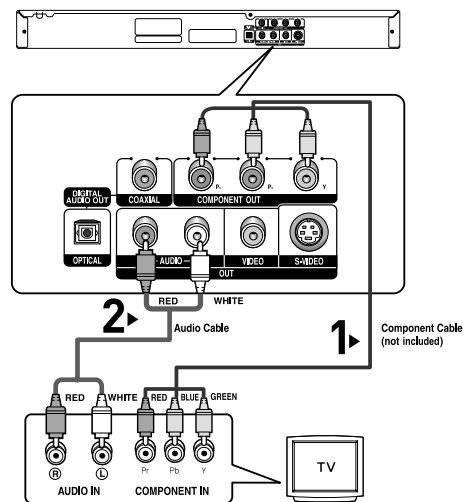

Note

- **If Video output is incorrectly set to S-Video, the screen will turn red.**
- If you want to connect to an Amplifier, please refer to the Amplifier connection page. (See pages 15 to 16)
- The component terminal of TV can be marked by "R-Y, B-Y, Y" or "Cr, Cb, Y" instead of "P_R, P_B, Y" depending on the manufacturer. The number and position of terminals can vary depending on the TV set. Please refer to the user's manual of the TV.

CONNECTION

Connection to a TV (Progressive)

1

Using component video cables (not included), connect the **COMPONENT VIDEO OUT** terminal on the rear of the DVD player to the **COMPONENT IN** terminal of TV.

2

Using the audio cables, connect the **AUDIO (red and white) OUT** terminals on the rear of the DVD player to the **AUDIO (red and white) IN** terminals of TV. Turn on the DVD player and TV.

3

Press the **TV/VIDEO** button on the TV's remote control to select **Component** or **DVD**.

4

Set the Video Output to **Component (P-SCAN)** in the Display Setup menu. (See pages 50 to 51)

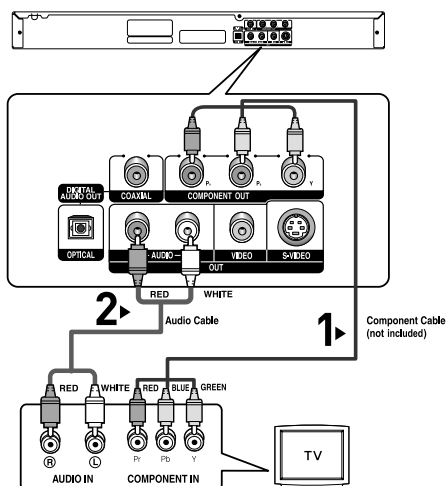

To see the progressive video output,

- Consult your TV User's Manual to find out if your TV supports Progressive Scan. If Progressive Scan is supported, follow the TV User's Manual regarding Progressive Scan settings in the TV's menu system.
- Depending on your TV, the connection method may differ from the illustration above.

Note

- What is "Progressive Scan"?
Progressive scan has twice as many scanning lines as the interlace output method has. Progressive scanning method can provide better and clearer picture quality.

CONNECTION

Connection to an Audio System (2 Channel Amplifier)

1

Using the audio cables, connect the **AUDIO (red and white) OUT** terminals on the rear of the DVD player to the **AUDIO (red and white) IN** terminals of the Amplifier.

2

Using the video signal cable(s), connect the **VIDEO, S-VIDEO** or **COMPONENT OUT** terminals on the rear of the DVD player to the **VIDEO, S-VIDEO** or **COMPONENT IN** terminal of your TV.

3

Turn on the DVD player, TV, and Amplifier.

4

Press the input select button of the Amplifier to select **external input** in order to hear sound from the DVD player.

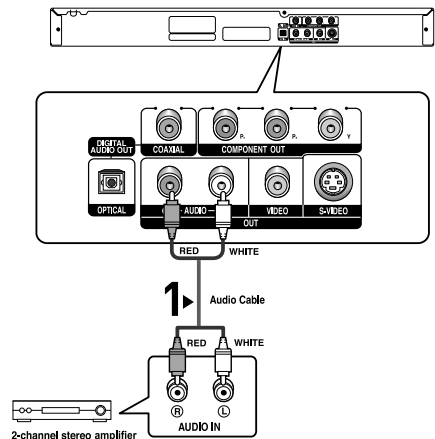

Note

- Please turn the volume down when you turn on the Amplifier. Sudden loud sound may cause damage to the speakers and your ears.
- Please set the audio in the menu screen according to the Amplifier. (See pages 48 to 49)
- The position of terminals can vary depending on the Amplifier. Please refer to the user's manual of the Amplifier.

CONNECTION

Connection to an Audio System (Dolby digital, MPEG2 or DTS Amplifier)

1

If using an optical cable (not included), connect the **DIGITAL AUDIO OUT (OPTICAL)** terminal on the rear of the DVD player to the **DIGITAL AUDIO IN (OPTICAL)** terminal of the Amplifier.
If using a coaxial cable (not included), connect the **DIGITAL AUDIO OUT (COAXIAL)** terminal on the rear of the DVD player to the **DIGITAL AUDIO IN (COAXIAL)** terminal of the Amplifier.

2

Using the video signal cable(s), connect the **VIDEO, S-VIDEO** or **COMPONENT OUT** terminals on the rear of the DVD player to the **VIDEO, S-VIDEO** or **COMPONENT IN** terminal of TV.

3

Turn on the DVD player, TV, and Amplifier.

4

Press the input select button of the Amplifier to select **external input** in order to hear sound from the DVD player.

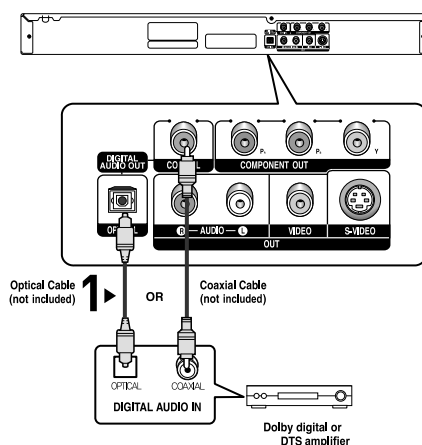

Note

- When you connect the DVD player to DTS Amplifier and play a DTS disc, set the DTS to On in Audio Setup menu. If it is set to Off, sound doesn't come out or there will be a big noise.
- Please turn the volume down when you turn on the Amplifier. Sudden loud sound may cause damage to the speakers and your ears.
- Please set the audio in the menu screen according to the Amplifier. (See pages 48 to 49)
- The position of terminals can vary depending on the Amplifier. Please refer to the user's manual of the Amplifier.
- Please remove the dust cover before using the optical cable (not included) and put the cover on the cable again when it's not used.

Chapter 3

BASIC FUNCTIONS

Playing a Disc

Before Play

- Turn on your TV and set it to the correct Video Input by pressing TV/VIDEO button on the TV remote control.
- If you connected an external Audio System, turn on your Audio System and set it to the correct Audio Input.

After plugging in the player, the first time you press the DVD **POWER** button, this screen comes up: If you want to select a language, press a **NUMBER** button. (This screen will only appear when you plug in the player for the first time.)

If the language for the startup screen is not set, the settings may change whenever you turn the power on or off. Therefore, make sure that you select the language you want to use.

Once you select a menu language, you can change it by pressing the **▶▶** button on the front panel of the unit for more than 5 seconds with no disc in the unit. Then the **SELECT MENU LANGUAGE** window appears again where you can reset your preferred language.



Playback

1

Press the **OPEN/CLOSE** (**▲**) button. The **STANDBY** indicator light goes out and the tray opens.

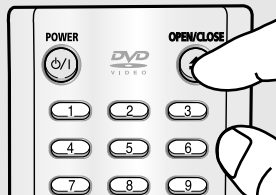

2

Place a disc gently into the tray with the disc's label facing up.



- ◀ You must only insert one DVD disc at a time. Inserting two or more discs will not allow to play them back and it may cause damage to the DVD player.

3

Press the **PLAY/PAUSE** (**▶||**) button or **OPEN/CLOSE** (**▲**) button to close the disc tray.

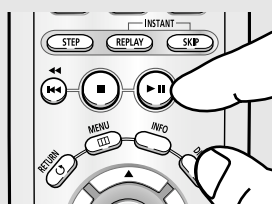

◀ RESUME function

When you stop disc play, the player remembers where you stopped, so when you press **PLAY/PAUSE** (**▶||**) button again, it will pick up where you left off. (unless the disc is removed or the player is unplugged, or if you press the **STOP** (**■**) button twice.)

BASIC FUNCTIONS

4

Stopping Play

Press the **STOP** (■) button during play.

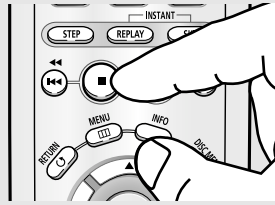

Note

- If the player is left in the stop mode for more than one minute without any user interaction, a screen saver will be activated. Press the PLAY/PAUSE (▶||) button to resume normal play.
- If the player is left in the stop mode for more than about 30 minutes, the power will automatically shut off except when the MIC is connected. (Automatic Power-Off Function)

5

Removing Disc

Press the **OPEN/CLOSE** (▲) button.

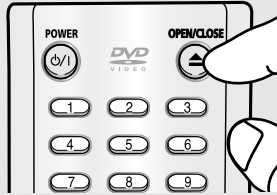

6

Pausing Play

Press the **PLAY/PAUSE** (▶||) or **STEP** button on the remote control during play.

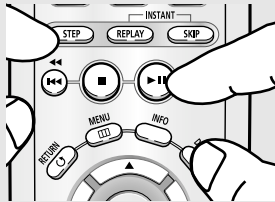

- ◀ Screen stops, no sound.
To resume, press the PLAY/PAUSE (▶||) button once again.

Note

If the player is left for about 5 minutes in pause mode, it will stop.

7

Step Motion Play (Except CD)

Press the **STEP** button on the remote control during play.

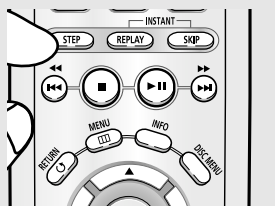

- ◀ Each time the button is pressed, a new frame will appear.
No sound is heard during STEP mode.
Press the PLAY/PAUSE (▶||) button to resume normal play.
You can only perform step motion play in the forward direction.

8

Slow Motion Play (Except CD)

Press and hold the **SEARCH** (▶▶) button to choose the play speed between 1/8, 1/4 and 1/2 of normal during PAUSE or STEP mode.

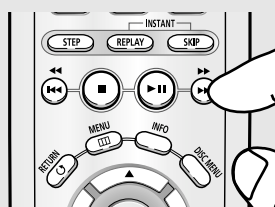

- ◀ No sound is heard during slow mode.
Press the PLAY/PAUSE (▶||) button to resume normal play.
Reverse slow motion play will not work.

Note

This (⊘) icon indicates an invalid button press.

Using the Search and Skip Functions

During play, you can search quickly through a chapter or track, and use the skip function to jump to the next selection.

Searching through a Chapter or Track

During play, press the **SEARCH** (◀◀ or ▶▶) button on the remote control for more than 1 second.

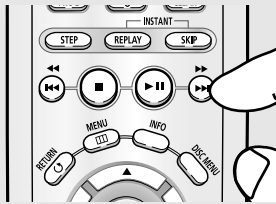

◀ If you want to search at a faster speed on the DVD, VCD or CD, press and hold the button.

DVD	2X, 8X, 32X, 128X
VCD	4X, 8X
CD	2X, 4X, 8X

Note

- The speed marked in this function may be different from the actual speed of playback.
- No sound is hearing during search mode (Except CD).

Skipping Tracks

During play, press the **SKIP** (◀◀ or ▶▶) button.

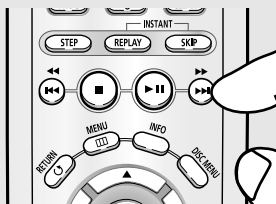

- When playing a DVD, if you press the SKIP (▶▶) button, it moves to the next chapter. If you press the SKIP (◀◀) button, it moves to the beginning of the chapter. One more press makes it move to the beginning of the previous chapter.
- When playing a VCD 2.0 in Menu Off mode, or a VCD 1.1 or a CD, if you press the SKIP (▶▶) button, it moves to the next track. If you press the SKIP (◀◀) button, it moves to the beginning of the track. One more press makes it move to the beginning of the previous track.
- If a track exceeds 15 minutes when playing a VCD and you press the ▶▶ button, it moves forward 5 minutes. If you press the ◀◀ button, it moves backward 5 minutes.

Note

Only Menu Off is available for VCD2.0.
Each press of the DISC MENU button toggles between Menu On and Menu Off.

BASIC FUNCTIONS

Using the Display Function

When Playing a DVD/VCD/CD

1

During play, press the **INFO** button on the remote control.

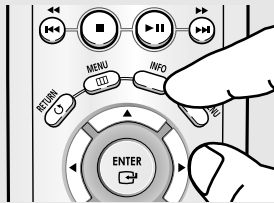

◀ You can select Info in the function menu by pressing the MENU button.

2

Press the **▲/▼** buttons to select the desired item.

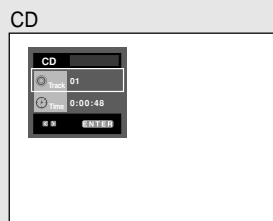
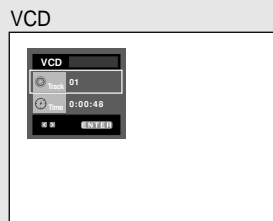

◀ Only Menu Off is available for VCD2.0. Each press of the DISC MENU button toggles between Menu On and Menu Off.

3

Press the **◀/▶** buttons to make the desired setup and then press the **ENTER** button.

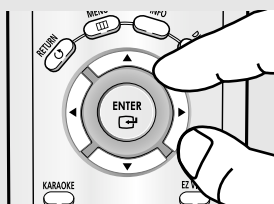

◀ You may use the number buttons of the remote control to directly access a title, chapter or to start the playback from the desired time.





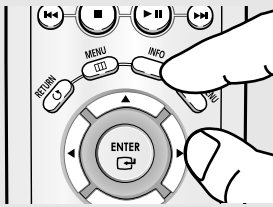

BASIC FUNCTIONS

4

To make the screen disappear, press the **INFO** button again.



Note

 Title	<p>To access the desired title when there is more than one in the disc. For example, if there is more than one movie on a DVD, each movie will be identified.</p>
 Chapter  Track	<p>Most DVD discs are recorded in chapters so that you can quickly find a specific passage (similar to tracks on an audio CD).</p>
 Time	<p>Allows playback of the film from a desired time. You must enter the starting time as a reference. The time search function does not operate on some disc.</p>
 Audio	<p>Refers to the language of the film soundtrack. In the example, the soundtrack is played in English 5.1CH. A DVD disc can have up to eight different soundtracks.</p>
 Subtitle	<p>Refers to the subtitle languages available in the disc. You will be able to choose the subtitle languages or, if you prefer, turn them off from the screen. A DVD disc can have up to 32 different subtitles.</p>

BASIC FUNCTIONS

Using the Disc and Title Menu

Using the Disc Menu

1

During the playback of a DVD disc, press the **MENU** button on the remote control.

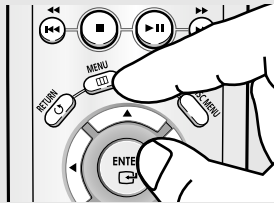

2

Press the ▲/▼ buttons to select **Disc Menu**, then press the ► or **ENTER** button.



Note

- Depending on a disc, the Disc Menu may not work.
 - You can also use the Disc Menu, using the DISC MENU button on the remote control.
 - Only Menu Off is available for VCD2.0.
- Each press of the DISC MENU button toggles between Menu On and Menu Off.

Using the Title Menu

1

During the playback of a DVD disc, press the **MENU** button on the remote control.

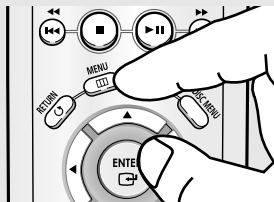

2

Press the ▲/▼ buttons to select **Title Menu**, then press the ► or **ENTER** button.



Note

- Depending on a disc, the Title Menu may not work.
- Title Menu will only be displayed if there are at least two titles in the disc.

Using the Function Menu

Using the Function Menu

1

Press the **MENU** button during playback.

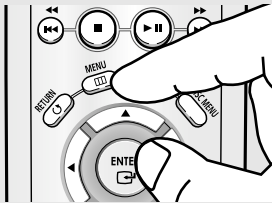

2

Press the ▲/▼ buttons to select **Function**, then press the ► or **ENTER** button.

- Info (See pages 20 to 21)
- Zoom (See page 34)
- Bookmark (See pages 32 to 33)
- Repeat (See pages 24 to 25)
- EZ View (See pages 27 to 28)

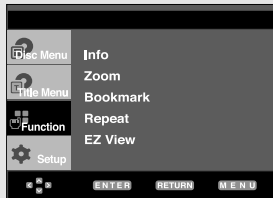

3

Press the ▲/▼ buttons to select one of the five functions. Then press the ► or **ENTER** button to access the function.

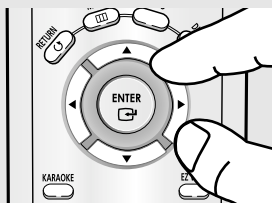

◀ You can also directly select these functions using their respective buttons on the remote control.

- INFO
- EZ VIEW
- REPEAT

BASIC FUNCTIONS

Repeat Play

Repeat the current track, chapter, title, a chosen section (A-B), or all of the disc.

When playing a DVD/VCD/CD

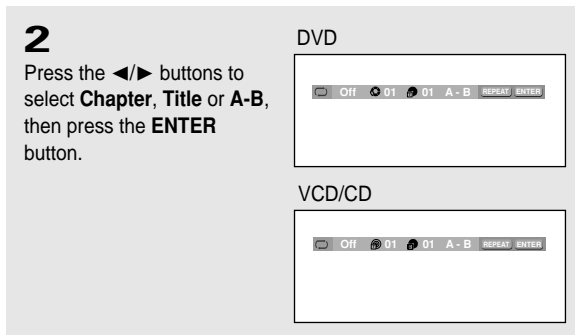
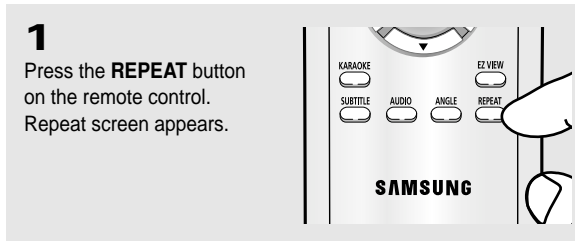

◀ DVD repeats play by chapter or title, CD and VCD repeat play by disc or track.

Chapter (📀): repeats the chapter that is playing.

Title (🎵): repeats the title that is playing.

Disc (📀): repeats the disc that is playing.

Track (🎵): repeats the track that is playing.

A-B: repeats a segment of the disc that you select.

Using the A-B Repeat function

1. Press the **REPEAT** button on the remote control.
2. Press the ◀/▶ buttons to Select **A-B** button.
3. Press the **ENTER** button at the point where you want repeat play to start (A).
B is automatically highlighted.
4. Press the **ENTER** button at the point where you want the repeat play to stop (B).
- To return to normal play, press the **CLEAR** button.

Note

A-B REPEAT does not allow you to set point (B) until at least 5 seconds of playback time has elapsed after point (A) has been set.

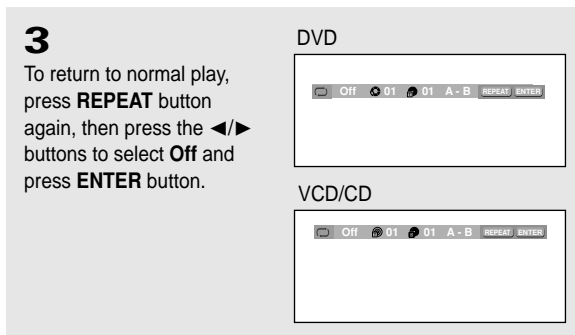

Note

- Depending on a disc, the Repeat function may not work.
- Only Menu Off is available for VCD2.0. Each press of the DISC MENU button toggles between Menu On and Menu Off.

BASIC FUNCTIONS

Slow Repeat Play

This feature allows you slowly to repeat scenes containing sports, dancing, musical instruments being played etc., so you can study them more closely.

When playing a DVD/VCD

1

During play, press the **PLAY/PAUSE (▶||)** button.

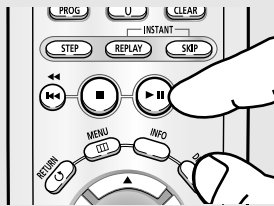

2

Press and hold the **SEARCH (▶▶)** button to choose the play speed between 1/8, 1/4 and 1/2 of normal during PAUSE or STEP mode.

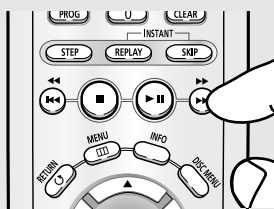

3

Press the **REPEAT** button on the remote control. Press the **◀/▶** buttons to select **A-B**.

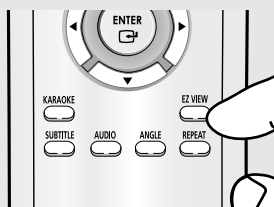

◀ The disc will play from A to B repeatedly at the speed you chose.

4

Press the **ENTER** button at the point where you want repeat play to start (A). **B** is automatically highlighted. Press the **ENTER** button at the point where you want the repeat play to stop (B).

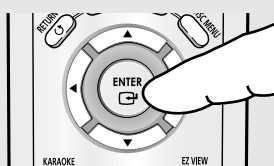

◀ To set A-B REPEAT, set (A) position first and then set (B) position after specified delay regarding the playback speed as followings:
 1/8x: after 40 seconds
 1/4x: after 20 seconds
 1/2x: after 10 seconds

5

To return to normal play, press the **CLEAR** button and then press the **PLAY/PAUSE (▶||)** button.



Note

Only Menu Off is available for VCD2.0. Each press of the DISC MENU button toggles between Menu On and Menu Off.

BASIC FUNCTIONS

Program Play & Random Play

Program Play (CD)

Program Play allows you to select the order in which you want tracks to play.

1
During play, press the **PROG** button.

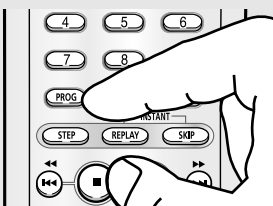

2
Press the ◀/▶ buttons to select **PROGRAM**.
Press the **ENTER** button.

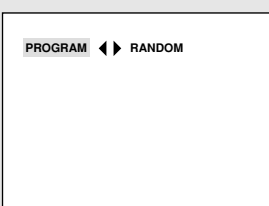

3
Press the ▲/▼/◀/▶ buttons to select the first track to add to the program.
Press the **ENTER** button.
The selection numbers appear in the Program Order box.

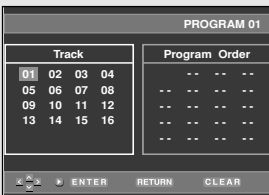

Track	Program Order
02 03 04	-- -- --
05 06 07 08	-- -- --
09 10 11 12	-- -- --
13 14 15 16	-- -- --

- ◀ - To return to the previous menu screen, press the **RETURN** button.
- To cancel the selected program order, press the **CLEAR** button.
- This unit can support a maximum of 20 programmed tracks.

4
Press the **PLAY/PAUSE** (▶||) button.
The disc will be played in programmed order.

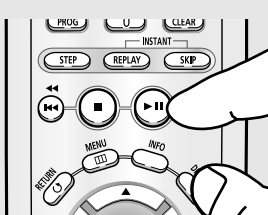

Random Play (CD)

Random Play plays a disc's tracks in random order.

1
Press the **PROG** button.

2
Press the ◀/▶ buttons to select **RANDOM**.
Press the **ENTER** button.

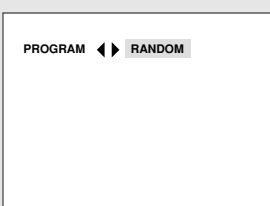

Note

- Depending on a disc, the Program and Random Play functions may not work.
- While in playback mode, press the **CLEAR** button on the remote control to cancel Program Play or Random Play.

Chapter 4

ADVANCED FUNCTIONS

Adjusting the Aspect Ratio (EZ View)

To play back using aspect ratio (DVD)

Press the **EZ VIEW** button.

- The screen size changes when the button is pressed repeatedly.
- The screen zoom mode operates differently depending on the screen setting in the Display Setup menu.
- To ensure correct operation of the **EZ VIEW** button, you should set the correct aspect ratio in the Display Setup menu. (See pages 50 to 51).

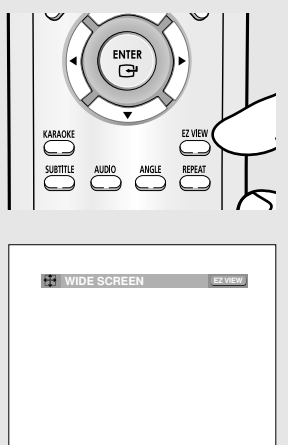

If you are using a 16:9 TV

For 16:9 aspect ratio discs

- **WIDE SCREEN**
Displays the content of the DVD title in 16:9 aspect ratio.
- **SCREEN FIT**
The top and bottom portions of the screen are cut off. When playing a 2.35:1 aspect ratio disc, the black bars at the top and bottom of the screen will disappear. The picture will look vertically stretched. (Depending on a type of disc, the black bars may not disappear completely.)
- **ZOOM FIT**
The top, bottom, left and right of the screen are cut off and the central portion of the screen is enlarged.

For 4:3 aspect ratio discs

- **Normal Wide**
Displays the content of the DVD title in 16:9 aspect ratio. The picture will look horizontally stretched.
- **SCREEN FIT**
The top and bottom portions of the screen are cut off and the full screen appears. The picture will look vertically stretched.
- **ZOOM FIT**
The top, bottom, left and right portions of the screen are cut off and the central portion of the screen is enlarged.
- **Vertical Fit**
When a 4:3 DVD is viewed on a 16:9 TV, black bars will appear at the left and right of the screen in order to prevent the picture from looking horizontally stretched.

ADVANCED FUNCTIONS

If you are using a 4:3 TV

For 16:9 aspect ratio discs

- 4:3 Letter Box

Displays the content of the DVD title in 16:9 aspect ratio.
The black bars will appear at the top and bottom of the screen.

- 4:3 Pan Scan

The left and right portions of the screen are cut off and the central portion of the 16:9 screen is displayed.

- SCREEN FIT

The top and bottom portions of the screen are cut off and a full screen appears.
The picture will look vertically stretched.

- ZOOM FIT

The top, bottom, left and right of the screen are cut off and the central portion of the screen is enlarged.

For 4:3 aspect ratio discs

- Normal Screen

Displays the content of the DVD title in 4:3 aspect ratio.

- SCREEN FIT

The top and bottom portions of the screen are cut off and the full screen appears.
The picture will look vertically stretched.

- ZOOM FIT

The top, bottom, left and right portions of the screen are cut off and the central portion of the screen is enlarged.

Note

This function may behave differently depending on the type of disc.

Selecting the Audio Language

You can select a desired audio language quickly and easily with the AUDIO button.

Using the AUDIO button

1

Press the **AUDIO** button.
The Audio changes when the button is pressed repeatedly.
The audio languages are represented by abbreviations.

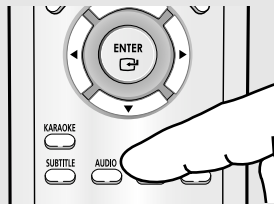

DVD



When playing a VCD or CD, you can select among **Stereo**, **Right** or **Left**.

VCD/CD



2

To remove the **AUDIO** icon, press the **CLEAR** or **RETURN** button.



Note

- This function depends on audio languages are encoded on the disc and may not work.
- A DVD disc can contain up to 8 audio languages.
- To have the same audio language come up whenever you play a DVD; Refer to "Using the Audio Language" on page 46.

ADVANCED FUNCTIONS

Selecting the Subtitle Language

You can select a desired subtitle quickly and easily with the SUBTITLE button.

Using the SUBTITLE button (DVD)

1

Press the **SUBTITLE** button.

The subtitle languages are represented by abbreviations. The subtitle changes when the button is pressed repeatedly.

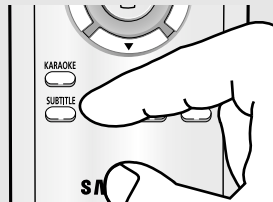

DVD



2

To remove the **SUBTITLE** icon, press the **CLEAR** or **RETURN** button.

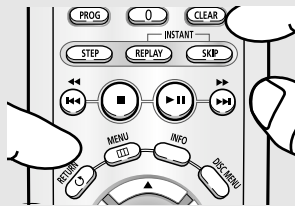

Note

- You have to change the desired subtitle in the Disc Menu, according to discs. Press the DISC MENU button.
- This function depends on what subtitles are encoded on the disc and may not work on all DVDs.
- A DVD disc can contain up to 32 subtitle languages.
- To have the same subtitle language come up whenever you play a DVD; Refer to "Using the Subtitle Language" on page 47.

Changing the Camera Angle

When a DVD contains multiple angles of a particular scene, you can use the ANGLE function.

Using the ANGLE button (DVD)

If the disc contains multiple angles, the ANGLE appears on the screen.

1

Press the **ANGLE** button, then the ANGLE icon will appear with the current angle number and the number of angles available.

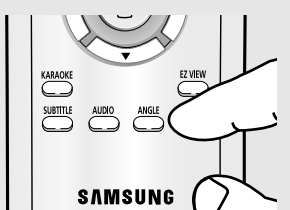

2

Press the **ANGLE** button repeatedly to select the desired angle. To remove the ANGLE icon, press the **CLEAR** or **RETURN** button.



Note

If the disc has only one angle, this feature won't work. Currently, very few discs have this feature.

Using the Instant Replay/Skip Function

Using the Instant Replay function (DVD)

If you miss a scene, you can see it again using this function.

If you press the **INSTANT REPLAY** button, the current scene moves backward about 10 seconds, and plays back.

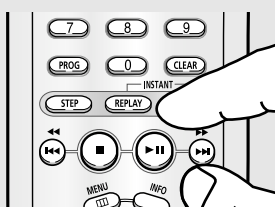

Using the Instant Skip function (DVD)

Use this function to skip playback about 10 seconds ahead of the current scene.

Press the **INSTANT SKIP** button.

- Playback will skip ahead 10 seconds.

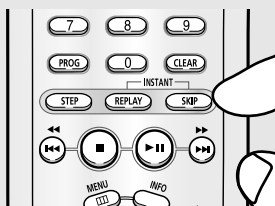

Note

Depending on the disc, these functions may not work.

ADVANCED FUNCTIONS

Using the Bookmark Function

This feature lets you bookmark sections of a DVD or VCD (Menu Off mode) so you can quickly find them at a later time.

Using the Bookmark Function (DVD/VCD)

1

During play, press the **MENU** button on the remote control.

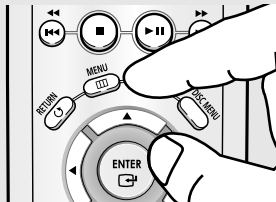

2

Press the **▲/▼** buttons to select **Function**, then press the **▶** or **ENTER** button.



3

Press the **▲/▼** buttons to select **Bookmark**, then press the **▶** or **ENTER** button.



4

When you reach the scene you want to mark, press the **ENTER** button. Up to three scenes may be marked at a time.



Note

- Only Menu Off is available for VCD2.0. Each press of the DISC MENU button toggles between Menu On and Menu Off.
- Depending on a disc, the Bookmark function may not work.

ADVANCED FUNCTIONS

Recalling a Marked Scene

1~3

The first 1~3 steps are the same as those for "Using the Bookmark Function" on page 32.

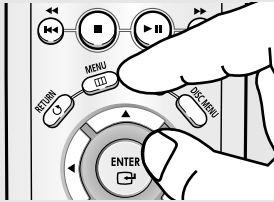

4

Press the ◀/▶ buttons to select a marked scene.

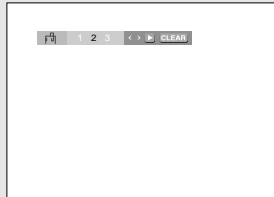

5

Press the **PLAY/PAUSE** (▶||) button to skip to the marked scene.

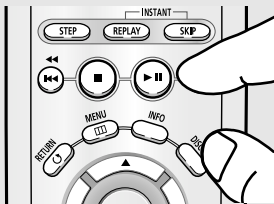

Clearing a Bookmark

1~3

The first 1~3 steps are the same as those for "Using the Bookmark Function" on page 32.

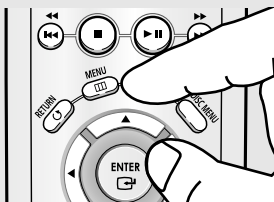

4

Press the ◀/▶ buttons to select the bookmark number you want to delete.



5

Press the **CLEAR** button to delete a bookmark number.

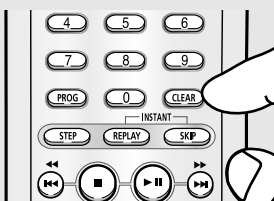

ADVANCED FUNCTIONS

Using the Zoom Function

Using the Zoom Function (DVD/VCD)

1

During play or pause mode, press the **MENU** button on the remote control.

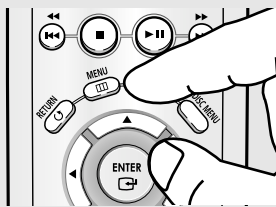

2

Press the **▲/▼** buttons to select **Function**, then press the **▶** or **ENTER** button.



3

Press the **▲/▼** buttons to select **Zoom**, then press the **▶** or **ENTER** button.

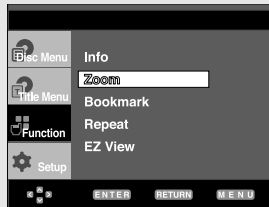

4

Press the **▲/▼** or **◀/▶** buttons to select the part of the screen you want to zoom in on. Press the **ENTER** button.

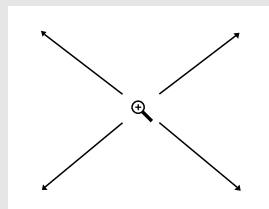

◀ During DVD play, press ENTER to zoom in 2X/4X/2X/Normal in order.
During VCD play, press ENTER to zoom in 2X/Normal in order.

ADVANCED FUNCTIONS

Clips Menu for MP3/WMA/JPEG

Discs with MP3/WMA/JPEG contain individual songs and/or pictures that can be organized into folders as shown below. They are similar to how you use your computer to put files into different folders.

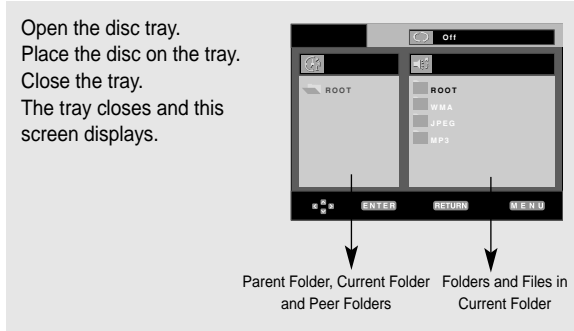

- : Name of currently playing file.
- : Current Playback Time.
- : Current Playback Mode : There are four modes. They can be selected in order by pressing the **REPEAT** button.
 - Off: Normal Playback
 - Track: Repeats the current track.
 - Folder: Repeats the current folder.
 - Random: Files in the disc will be played in random order.
- : MP3 file icon.
- : WMA file icon.
- : JPEG file icon.
- : Folder icon.
- : Current Folder icon.

Folder Selection

The folder can only be selected in the Stop mode.

- **To select the Parent Folder**
Press the **RETURN** button to go to parent folder, or press the **▲/▼** buttons to select “..” and press **ENTER** to go to the parent folder.
- **To select the Peer Folder**
Press the **◀/▶** buttons to highlight left window. Press the **▲/▼** buttons to select the desired folder, then press **ENTER**.
- **To select the Sub-Folder**
Press the **◀/▶** buttons to highlight right window. Press the **▲/▼** buttons to select the desired folder, then press **ENTER**.

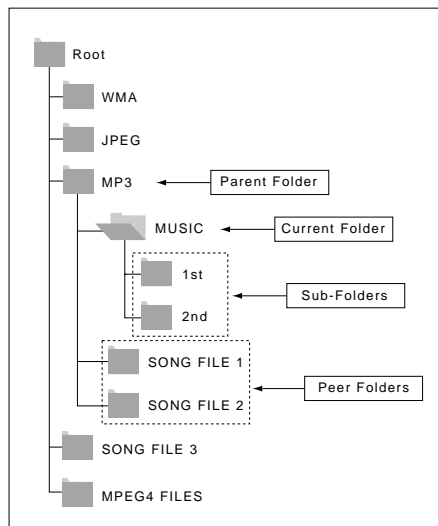

ADVANCED FUNCTIONS

MP3/WMA Playback

1

Open the disc tray.
Place the disc on the tray.
Close the tray.



◀ Only one kind of file is played back when a disc or a folder contains both MP3 and WMA files.

2

Press the ▲/▼ or ◀/▶ buttons to select a song file.
Press **ENTER** to begin playback of the song file.

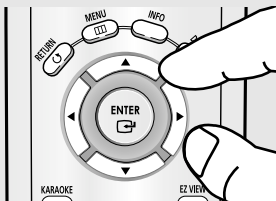

Repeat/Random playback

1

Press the **REPEAT** button to change the playback mode. There are four modes, such as **Off**, **Track**, **Folder** and **Random**.

- Off: Normal Playback
- Track: Repeats the current song file.
- Folder: Repeats the song files which have the same extension in the current folder.
- Random: Song files which have the same extension will be played in random order.

To resume normal play, press the **CLEAR** button.

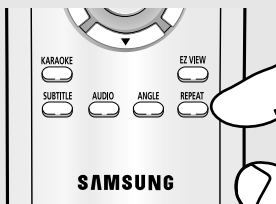

CD-R MP3/WMA file

When you record MP3 or WMA files on CD-R, please refer to the following.

- Your MP3 or WMA files should be ISO 9660 or JOLIET format.

ISO 9660 format and Joliet MP3 or WMA files are compatible with Microsoft's DOS and Windows, and with Apple's Mac. This format is the most widely used.

- When naming your MP3 or WMA files, do not exceed 8 characters, and enter ".mp3, .wma" as the file extension.

General name format : Title.mp3. or Title.wma. When composing your title, make sure that you use 8 characters or less, have no spaces in the name, and avoid the use of special characters including: (,.,\,=,+).

- Use a decompression transfer rate of at least 128 Kbps when recording MP3 files.

Sound quality with MP3 files basically depends on the rate of compression/decompression you choose. Getting CD audio sound requires an analog/digital sampling rate, that is conversion to MP3 format, of at least 128 Kbps and up to 160 Kbps. However, choosing higher rates, like 192 Kbps or more, only rarely give better sound quality. Conversely, files with decompression rates below 128 Kbps will not be played properly.

- Use a decompression transfer rate of at least 64Kbps when recording WMA files.

Sound quality with WMA files basically depends on the rate of compression/decompression you choose.

Getting CD audio sound requires an analog/digital sampling rate, that is conversion to WMA format, of at least 64Kbps and up to 192Kbps.

Conversely, files with decompression rates below 64Kbps or over 192Kbps will not be played properly.

- Do not try recording copyright protected MP3 files.

Certain "secured" files are encrypted and code protected to prevent illegal copying. These files are of the following types: Windows Media™ (registered trade mark of Microsoft Inc) and SDMI™ (registered trade mark of The SDMI Foundation). You cannot copy such files.

- Important:

The above recommendations cannot be taken as a guarantee that the DVD player will play MP3 recordings, or as an assurance of sound quality. You should note that certain technologies and methods for MP3 file recording on CD-Rs prevent optimal playback of these files on your DVD player (degraded sound quality and in some cases, inability of the player to read the files).

- This unit can play a maximum of 3000 files and 300 folders per disc.

ADVANCED FUNCTIONS

Picture CD Playback

1

Select the desired folder.



2

Press the ▲/▼ buttons to select a Picture file in the clips menu and then press the **ENTER** button.



3

Press the **INFO** button on the remote control to select the menu you want to view and then press the **ENTER** button.

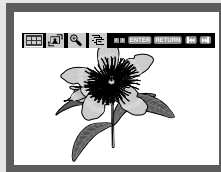

Note

- If no buttons on the remote control are pressed for 10 seconds, the menu will disappear.
- Press the **STOP** button to return to the clips menu.
- When playing a Kodak Picture CD, the unit displays the Photo directly, not the clips menu.

Album Screen

-  : Returns to the Album Screen.
- To see the next six pictures, press the **▶▶** button.
- To see the previous six pictures, press the **◀◀** button.

Rotation

-  : Each time the **ENTER** button is pressed, the picture rotates 90 degrees clockwise.

Zoom





-  : Press the ▲/▼ or ◀/▶ buttons to select the part of the screen you want to zoom in on. Press the **ENTER** button. Each time the **ENTER** button is pressed, the picture is enlarged up to 4X. (2X → 4X → 2X → Normal)

Note

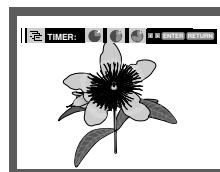
- Depending on a file size, the amount of time between each picture may be different from the manual.
- If you don't press any button, the slide show will start automatically in about 10 seconds by default.

Slide Show



-  : The unit enters slide show mode.
- Before beginning the Slide Show, the picture interval must be set.
-  : When this icon is selected and **ENTER** is pressed, the pictures change automatically with about a 6 second interval.
-  : The pictures change automatically with about a 12 second interval.
-  : The pictures change automatically with about a 18 second interval.

ADVANCED FUNCTIONS

CD-R JPEG Discs

- Only files with the ".jpg" and ".JPG" extensions can be played.
- If the disc is not closed, it will take longer to start playing and not all of the recorded files may be played.
- Only CD-R discs with JPEG files in ISO 9660 or Joliet format can be played.
- The name of the JPEG file may not be longer than 8 characters and should contain no blank spaces or special characters (. / = +).
- Only a consecutively written multi-session disc can be played. If there is a blank segment in the multi-session disc, the disc can be played only up to the blank segment.
- A maximum of 3000 images can be stored on a single CD.
- Kodak Picture CDs are recommended.
- When playing a Kodak Picture CD, only the JPEG files in the pictures folder can be played.
- Kodak Picture CD: The JPEG files in the pictures folder can be played automatically.
- Konica Picture CD: If you want to see the Picture, select the JPEG files in the clips menu.
- Fuji Picture CD: If you want to see the Picture, select the JPEG files in the clips menu.
- QSS Picture CD: The unit may not play QSS Picture CD.
- If the number of files in 1 Disc is over 3000, only 3000 JPEG files can be played.
- If the number of folders in 1 Disc is over 300, only JPEG files in 300 folders can be played

Chapter 5

KARAOKE FUNCTIONS

Karaoke Functions

Operation Sequence

1

Connect the Mixed Audio Out terminals with the TV or Amplifier.
(see page 11 to 15)

2

Connect Mic into Mic 1 or Mic 2 jack (DVD-P255K).
When a MIC is connected, the karaoke functions can be used.

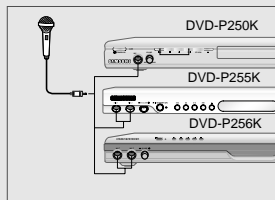

Key Control

1

Playback the Karaoke Disc containing the wanted songs.
Press the **KARAOKE** button.

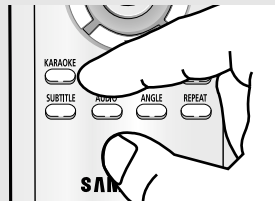

2

Press the ◀/▶ buttons to select **Keycon**, then press the **ENTER** button.

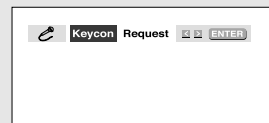

3

Press the ◀/▶ buttons to change the desired tone.
- To let 7 scales down by half scale.
- Original scale.
- To let 7 scales up by half scale.

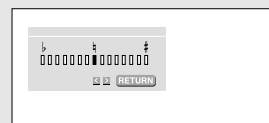

Note

- If you hear feedback (squealing or howling) while using the karaoke feature, move the microphone away from the speakers or turn down the microphone volume or the speaker volume.
- When playing MP3, WMA, DTS and LPCM disc, the karaoke functions will not operate.
- When the MIC is connected, Digital Out does not work.
- If the MIC is connected in VCD 2.0, Playback is selected to Menu off mode automatically.
- The MIC sound outputs only from Analog Audio Out.

KARAOKE FUNCTIONS

Reserving a Song

It is the function to reserve the desired song in advance by use of Karaoke function.

Sequence of reservation

1

Playback the Karaoke Disc containing the wanted songs. Press the **KARAOKE** button.

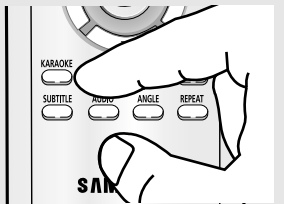

2

Press the ◀/▶ buttons to select **Request**, then press the **ENTER** button.

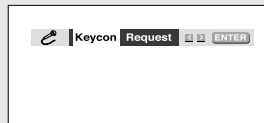

3

Input the number (Track or Chapter No.) of the desired song into the flickering part (-). You can reserve up to 10 songs.



◀ When you want the next reserved song during playing a song, press the SKIP (▶▶) button. When using SKIP (▶▶) button, it can not work at the last song.

Cancellation of reservation

1

Press the **KARAOKE** button.

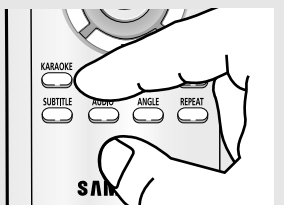

2

Press the ◀/▶ buttons to select **Request**, then press the **ENTER** button.

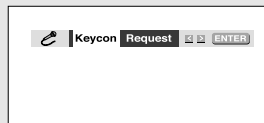

3

Press the **CLEAR** button to cancel the reserved song. The last reserved song will be erased first.

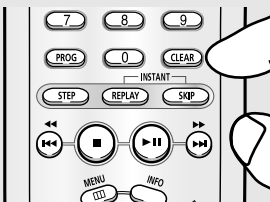

Note

- If the reservation is required again, input the song number in the flickering part.
- When using Request function, the "INFO" and "REPEAT" function does not work.
- Pressing the CLEAR button when the cursor is located on the number of the last song reserved will cancel all reservations.

KARAOKE FUNCTIONS

Vocal Function

When pressing the **KARAOKE** button twice, this screen displays.

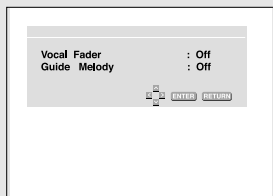

Vocal Fader

- In VCD, SVCD or CD, you can select only the L, R or Off.

	VOCAL FADER	Remark
↓	V1	CH1. Vocal Cancel
↓	V2	CH2. Vocal Cancel
↓	V1 + V2	CH1, CH2. Vocal Cancel
↓	OFF	Vocal Fader Off

Guide Melody

- The guide melody through xylophone and piano helps you sing easily.

Types of Karaoke disc

- DVD Karaoke Disc

Channel	Karaoke -Channel	5CH. DVD	2CH. DVD
1 CH	L	Left stereo music	Left stereo music + Vocal
2 CH	R	Right stereo music	Right stereo music + Vocal
3 CH	M	Guide melody	-
4 CH	V1	Vocal track	-
5 CH	V2	Vocal track	-

- CVD, VCD Karaoke Disc

Channel	Karaoke -Channel	CVD	VCD, CD
1 CH	CH1 LEFT	Left stereo music + Vocal	Left stereo music
1 CH	CH1 RIGHT	Right stereo music + Vocal	Right stereo music + Vocal
2 CH	CH2 LEFT	Left stereo music	-
2 CH	CH2 RIGHT	Right stereo music	-

Note

- This function works only on the DVD Karaoke disc on which the vocal fader or guide melody is recorded.

Chapter 6

CHANGING SETUP MENU

Using the Setup Menu

The Setup menu lets you customize your DVD player by allowing you to select various language preferences, set up a parental level, even adjust the player to the type of television screen you have.

1

With the unit in Stop mode, press the **MENU** button on the remote control.

Use the **▲/▼** buttons to select Setup, then press the **▶** or **ENTER** button.

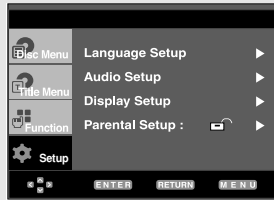

- ❶ Language Setup: Setup of the Language.
- ❷ Audio Setup : Setup of the Audio Options.
- ❸ Display Setup : Setup of the Display Options. Use to select which type of screen you want to watch and several display options.
- ❹ Parental Setup :Setup of the Parental Level. Allows users to set the level necessary to prevent children from viewing unsuitable movies such as those with violence, adult subject matter, etc.

2

Press the **▲/▼** buttons to access the different features. Press the **▶** or **ENTER** button to access the sub features.

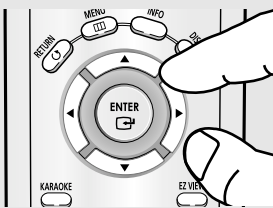

3

To make the setup screen disappear after setting up, press the **MENU** button again.

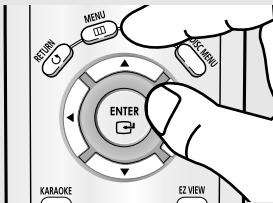

Note

Depending on the disc, some Setup Menu selections may not work.

CHANGING SETUP MENU

Setting Up the Language Features

If you set the player menu, disc menu, audio and subtitle language in advance, they will come up automatically every time you watch a movie.

Using the Player Menu Language

1

With the unit in Stop mode, press the **MENU** button.

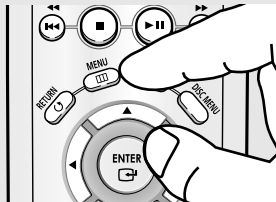

2

Press the **▲/▼** buttons to select **Setup**, then press the **▶** or **ENTER** button.



3

Press the **▲/▼** buttons to select **Language Setup**, then press the **▶** or **ENTER** button.



4

Press the **▲/▼** buttons to select **Player Menu**, then press the **▶** or **ENTER** button.



5

Press the **▲/▼** buttons to select the desired language, then press the **▶** or **ENTER** button.



- ◀ - The language is selected and the screen returns to Language Setup menu.
- To make the setup menu disappear, press the MENU button.

CHANGING SETUP MENU

Using the Disc Menu Language

This function changes the text language only on the disc menu screens.

1

With the unit in Stop mode, press the **MENU** button.

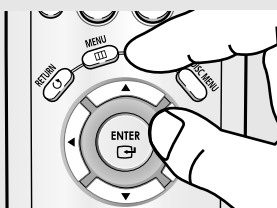

2

Press the ▲/▼ buttons to select **Setup**, then press the ► or **ENTER** button.

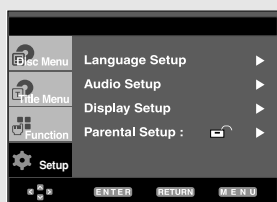

3

Press the ▲/▼ buttons to select **Language Setup**, then press the ► or **ENTER** button.



4

Press the ▲/▼ buttons to select **Disc Menu**, then press the ► or **ENTER** button.



5

Press the ▲/▼ buttons to select the desired language, then press the ► or **ENTER** button.



- ◀ - Select "Others" if the language you want is not listed.
- If the selected language is not recorded on the disc, the original pre-recorded language is selected.
- The language is selected and the screen returns to Language Setup menu.
- To make the setup menu disappear, press the MENU button.

CHANGING SETUP MENU

Using the Audio Language

1

With the unit in Stop mode, press the **MENU** button.

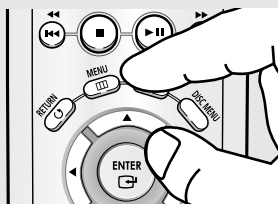

2

Press the ▲/▼ buttons to select **Setup**, then press the ► or **ENTER** button.

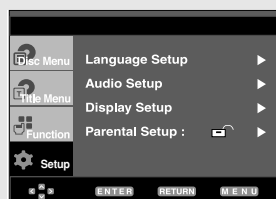

3

Press the ▲/▼ buttons to select **Language Setup**, then press the ► or **ENTER** button.



4

Press the ▲/▼ buttons to select **Audio**, then press the ► or **ENTER** button.



5

Press the ▲/▼ buttons to select the desired language, then press the ► or **ENTER** button.



- ◀ - Select "Original" if you want the default soundtrack language to be the original language the disc is recorded in.
- Select "Others" if the language you want is not listed.
- If the selected language is not recorded on the disc, the original pre-recorded language is selected.
- The language is selected and the screen returns to Language Setup menu.
- To make the setup menu disappear, press the MENU button.

CHANGING SETUP MENU

Using the Subtitle Language

1

With the unit in Stop mode, press the **MENU** button.

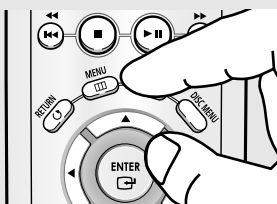

2

Press the ▲/▼ buttons to select **Setup**, then press the ► or **ENTER** button.



3

Press the ▲/▼ buttons to select **Language Setup**, then press the ► or **ENTER** button.



4

Press the ▲/▼ buttons to select **Subtitle**, then press the ► or **ENTER** button.



5

Press the ▲/▼ buttons to select the desired language, then press the ► or **ENTER** button.



- ◀ - Select "Automatic" if you want the subtitle language to be the same as the language selected as the audio language.
- Select "Others" if the language you want is not listed. Some discs may not contain the language you select as your initial language; in that case the disc will use its original language setting.
- The language is selected and the screen returns to setup menu.
- To make the setup menu disappear, press the MENU button.

CHANGING SETUP MENU

Setting Up the Audio Options

Audio Options allows you to setup the audio device and sound status settings depending on the audio system in use.

1

With the unit in Stop mode, press the **MENU** button.

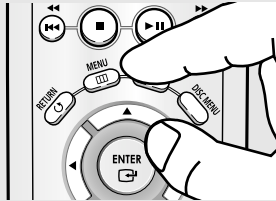

2

Press the **▲/▼** buttons to select **Setup**, then press the **▶** or **ENTER** button.



3

Press the **▲/▼** buttons to select **Audio Setup**, then press the **▶** or **ENTER** button.



4

Press the **▲/▼** buttons to select the desired item, then press the **▶** or **ENTER** button.

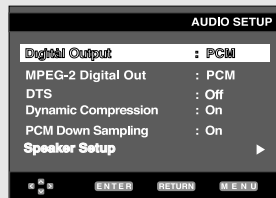

CHANGING SETUP MENU

❶ Dolby Digital Out

- PCM : Converts to PCM(2CH) audio.
- Bitstream : Outputs Dolby Digital via the digital output. Select Bitstream when connecting to a Dolby Digital Decoder.

❷ MPEG-2 Digital Out

- PCM : Converts to PCM(2CH) audio.
- Bitstream : Converts to MPEG-2 Digital Bitstream (5.1CH or 8CH). Select Bitstream when using the Digital Audio Output.

❸ DTS

- Select On when connecting to a DTS Decoder.
- Off : Doesn't output digital signal.
- On : Outputs DTS Bitstream via digital output.

Note

- There is no analog audio output when you play a DTS sound disc.

❹ Dynamic Compression

- On : To select dynamic compression.
- Off : To select the standard range.

❺ PCM Down Sampling

- On : Select this when the Amplifier connected to the player is not 96KHz compatible. In this case, the 96KHz signals will be down converted to 48KHZ.
- Off : Select this when the Amplifier connected to the player is 96KHz compatible. In this case, all signals will be output without any changes.

Note

Even when PCM Down sampling is Off

- Some discs will only output down sampled audio through the digital outputs.

Note

- To make the Setup menu disappear, press the MENU button.

Manufactured under license from Dolby Laboratories. "Dolby" and the double-D symbol are trademarks of Dolby Laboratories.

"DTS" and "DTS Digital Out" are trademarks of Digital Theater Systems, Inc.

CHANGING SETUP MENU

Setting Up the Display Options

Display options enable you to set various video functions of the player.

1

With the unit in Stop mode, press the **MENU** button.

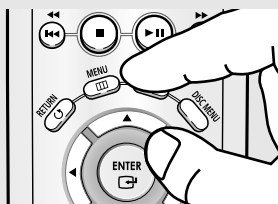

2

Press the ▲/▼ buttons to select **Setup**, then press the ► or **ENTER** button.



3

Press the ▲/▼ buttons to select **Display Setup**, then press the ► or **ENTER** button.



4

Press the ▲/▼ buttons to select the desired item, then press the ► or **ENTER** button.

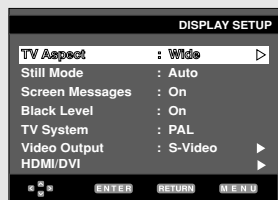

CHANGING SETUP MENU

1 TV Aspect

Depending on a type of television you have, you may want to adjust the screen setting (aspect ratio).

- 4:3 Letter Box : Select when you want to see the total 16:9 ratio screen DVD supplies, even though you have a TV with a 4:3 ratio screen. Black bars will appear at the top and bottom of the screen.
- 4:3 Pan Scan : Select this for conventional size TVs when you want to see the central portion of the 16:9 screen. (Extreme left and right side of movie picture will be cut off.)
- 16:9 Wide : You can view the full 16:9 picture on your wide screen TV.

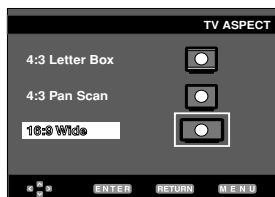

2 Still Mode

These options will help prevent picture shake in still mode and display small text clearer.

- Auto : When selecting Auto, Field/Frame mode will be automatically converted.
- Field : Select this feature when the screen shakes in the Auto mode.
- Frame : Select this feature when you want to see small letters more clearly in the Auto mode.

3 Screen Messages

Use to turn on-screen messages On or Off.

4 Black Level

Adjusts the brightness of the screen.(On or Off) It does not function in Progressive mode.

5 TV System

- NTSC : In case of using NTSC disc
- If your TV system only has PAL-Video input, you must choose "PAL". When you choose "PAL", Interlace output format is PAL 60 Hz output.
- If your TV system only has NTSC, input you must choose "NTSC".
- PAL : In case of using PAL disc

- If your TV system only has NTSC-Video input, you must choose "NTSC".
- If your TV system only has PAL input, you must choose "PAL".

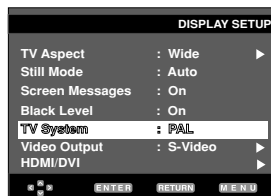

6 Video Output

Select Video Output.

- S-Video : Select when you want to use Video and S-Video Out.
- Component (I-SCAN) : Select when you want to use Component Interlace (625i/525i) Out.
- Component (P-SCAN) : Select when you want to use Component Progressive (625p/525p) Out.
- If the Yes/No selection in the Display Setup sub Menu is not made within 10 seconds, the screen returns to the previous menu.

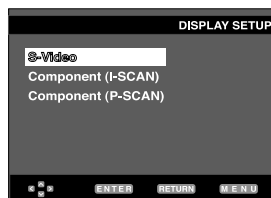
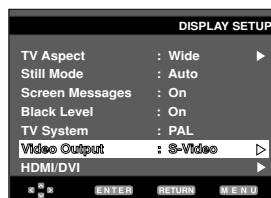

- Consult your TV User's Manual to find out if your TV supports Progressive Scan. If Progressive Scan is supported, follow the TV User's Manual regarding Progressive Scan settings in the TV's menu system.
- If Video Output is set incorrectly, the screen may be blocked.

CHANGING SETUP MENU

Setting Up the Parental Control

The Parental Control function works in conjunction with DVDs that have been assigned a rating, which helps you control the types of DVDs that your family watches. There are up to 8 rating levels on a disc.

1

With the unit in Stop mode, press the **MENU** button.

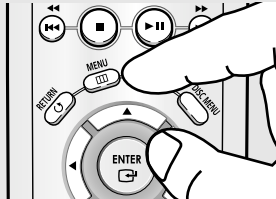

2

Press the **▲/▼** buttons to select **Setup**, then press the **▶** or **ENTER** button.



3

Press the **▲/▼** buttons to select **Parental Setup**, then press the **▶** or **ENTER** button.

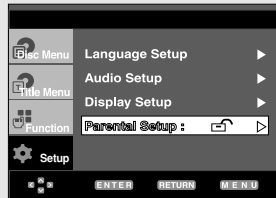

4

Press the **▶** or **ENTER** button to select **Yes** if you want to use a password. The Enter Password screen appears.

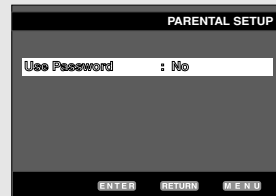

5

Enter your password. The Re-enter Password screen appears to confirm the password. Enter your password again. The player is locked (🔒).

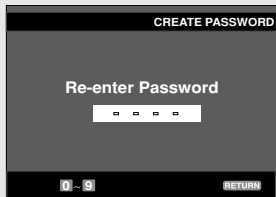
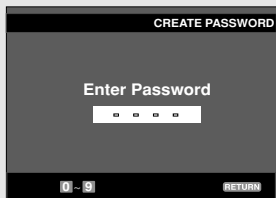

CHANGING SETUP MENU

Setting Up the Rating Level

1

With the unit in Stop mode, press the **MENU** button.

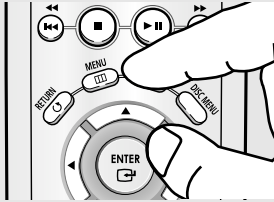

2

Press the ▲/▼ buttons to select **Setup**, then press the ► or **ENTER** button.



3

Press the ▲/▼ buttons to select **Parental Setup**, then press the ► or **ENTER** button.



4

Enter your password.

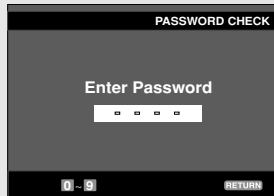

5

Press the ▲/▼ buttons to select **Rating Level**, then press the ► or **ENTER** button.

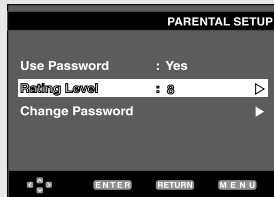

6

Press the ▲/▼ buttons to select the Rating Level you want, then press the ► or **ENTER** button.
e.g) Setting up in **Level 6**.



◀ To make the setup menu disappear, press the **MENU** button.

For example, if you select up to Level 6, discs that contain Level 7,8 will not play.

CHANGING SETUP MENU

Changing the Password

1

With the unit in Stop mode, press the **MENU** button.

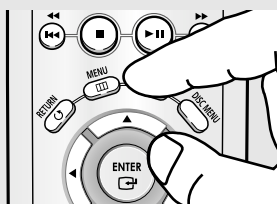

2

Press the ▲/▼ buttons to select **Setup**, then press the ► or **ENTER** button.



3

Press the ▲/▼ buttons to select **Parental Setup**, then press the ► or **ENTER** button.
The Enter Password screen appears.
Enter your password.



4

Press the ▲/▼ button to select **Change Password**, then press the ► or **ENTER** button.
Enter your new password.
Re-enter the new password again.

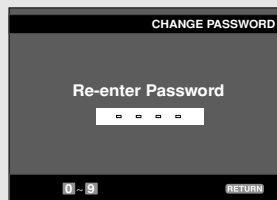
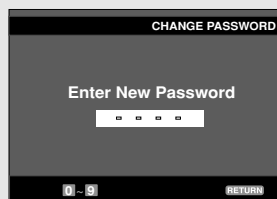
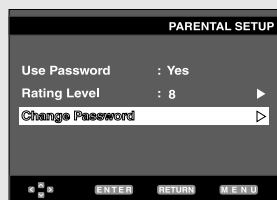

Note



If you have forgotten your password, see “Forgot Password” in the Troubleshooting Guide.

Chapter 7

REFERENCE

Troubleshooting

Before requesting service (troubleshooting), please check the following.

Problem	Action	Page
No operations can be performed with the remote control.	<ul style="list-style-type: none"> • Check the batteries in the remote control. They may need replacing. • Operate the remote control at a distance of no more than 20 feet. • Remove batteries and hold down one or more buttons for several minutes to drain the microprocessor inside the remote control to reset it. Reinstall batteries and try to operate the remote control again. 	P4
Disc does not play.	<ul style="list-style-type: none"> • Ensure that the disc is installed with the label side facing up. • Check the region number of the DVD. 	P7
5.1 channel sound is not being reproduced.	<ul style="list-style-type: none"> • 5.1 channel sound is reproduced only when the following conditions are met. : <ol style="list-style-type: none"> 1) The DVD player is connected with the proper Amplifier 2) The disc is recorded with 5.1 channel sound. • Check whether the disc being played has the "5.1 ch" mark on the outside. • Check if your audio system is connected and working properly. • In a SETUP Menu, is the Audio Output set to Bitstream? 	P16 P48-49
The  icon appears on screen.	<ul style="list-style-type: none"> • The features or action cannot be completed at this time because: <ol style="list-style-type: none"> 1. The DVD's software restricts it. 2. The DVD's software doesn't support the feature (e.g., angles). 3. The feature is not available at the moment. 4. You've requested a title or chapter number or search time that is out of range. 	
Disc Menu doesn't appear.	<ul style="list-style-type: none"> • Check if the disc has a Menu. 	
Play mode differs from the Setup Menu selection.	<ul style="list-style-type: none"> • Some of the functions selected in the Setup Menu may not work properly if the disc is not encoded with the corresponding function. 	P43-54
The screen ratio cannot be changed.	<ul style="list-style-type: none"> • The Screen Ratio is fixed on your DVDs. 	P50-51
No audio.	<ul style="list-style-type: none"> • Make sure you have selected the correct Digital Output in the Audio Options Menu. 	P48-49
The screen is blocked	<ul style="list-style-type: none"> • Press the  button for more than 5 seconds under no disc inside. All settings will revert to the factory settings. 	P17
Forgot password	<ul style="list-style-type: none"> • Press the  button for more than 5 seconds under no disc inside. All settings including the password will revert to the factory settings. Don't use this unless absolutely necessary. 	P52-54
If you experience other problems.	<ul style="list-style-type: none"> • Go to the contents and find the section of the instruction book that contains the explanations regarding the current problem, and follow the procedure once again. • If the problem still cannot be solved, please contact your nearest authorized service center. 	
The picture is noisy or distorted	<ul style="list-style-type: none"> • Make sure that the disc is not dirty or scratched. • Clean the disc. 	P2

REFERENCE

Specifications

General	Power Requirements	AC 110-240 V, 60/50 Hz
	Power Consumption	10 W
	Weight	1.7 Kg
	Dimensions	430mm (W) X 205mm (D) X 42mm (H) (DVD-P250K)
		430mm (W) X 212mm (D) X 42mm (H) (DVD-P255K)
	Operating Temperature Range	+5°C to +35°C
Operating Humidity Range	10 % to 75 %	
Disc	DVD (DIGITAL VERSATILE DISC)	Reading Speed : 3.49 ~ 4.06 m/sec. Approx. Play Time (Single Sided, Single Layer Disc) : 135 min.
	CD : 12Cm (COMPACT DISC)	Reading Speed : 4.8 ~ 5.6 m/sec. Maximum Play Time : 74 min.
	CD : 8Cm (COMPACT DISC)	Reading Speed : 4.8 ~ 5.6 m/sec. Maximum Play Time : 20 min.
	VCD : 12Cm	Reading Speed : 4.8 ~ 5.6 m/sec. Maximum Play Time : 74 min. (Video + Audio)
Video Output	Composite Video	1 channel : 1.0 Vp-p (75 Ω load)
	Component Video	Y : 1.0 Vp-p (75 Ω load) Pr : 0.70 Vp-p (75 Ω load) Pb : 0.70 Vp-p (75 Ω load)
		S-Video
Audio Output	2 Channel	L(1/L), R(2/R)
	*Frequency Response	48 kHz Sampling : 4 Hz to 22 kHz 96 kHz Sampling : 4 Hz to 44 kHz
		*S/N Ratio
	*Dynamic Range	100 dB
	*Total Harmonic Distortion	0.004 %

*: Nominal specification

- Samsung Electronics Co., Ltd reserves the right to change the specifications with out notice.
- Weight and dimensions are approximate.

MEMO

