

Veriton Series

User's Guide

Copyright © 2006. Acer Incorporated.
All Rights Reserved.

Veriton Series User's Guide
Original Issue: 08 / 2006

Changes may be made periodically to the information in this publication without obligation to notify any person of such revisions or changes. Such changes will be incorporated in new editions of this manual or supplementary documents and publications. This company makes no representations or warranties, either expressed or implied, with respect to the contents hereof and specifically disclaims the implied warranties of merchantability or fitness for a particular purpose.

Record the model number, serial number, purchase date, and place of purchase information in the space provided below. The serial number and model number are recorded on the label affixed to your computer. All correspondence concerning your unit should include the serial number, model number, and purchase information.

No part of this publication may be reproduced, stored in a retrieval system, or transmitted, in any form or by any means, electronically, mechanically, by photocopy, recording, or otherwise, without the prior written permission of Acer Incorporated.

Veriton Series Desktop Computer

Model number: _____

Serial number: _____

Purchase date: _____

Place of purchase: _____

Acer and the Acer logo are registered trademarks of Acer Incorporated. Other companies' product names or trademarks are used herein for identification purposes only and belong to their respective companies.

Information for your safety and comfort

Safety instructions

Read these instructions carefully. Keep this document for future reference. Follow all warnings and instructions marked on the product.

Turning the product off before cleaning

Unplug this product from the wall outlet before cleaning. Do not use liquid cleaners or aerosol cleaners. Use a damp cloth for cleaning.

Warnings

- Do not use this product near water.
- Do not place this product on an unstable cart, stand or table. If the product falls, it could be seriously damaged.
- Slots and openings are provided for ventilation to ensure reliable operation of the product and to protect it from overheating. These openings must not be blocked or covered. The openings should never be blocked by placing the product on a bed, sofa, rug or other similar surface. This product should never be placed near or over a radiator or heat register, or in a built-in installation unless proper ventilation is provided.
- Never push objects of any kind into this product through cabinet slots as they may touch dangerous voltage points or short-out parts that could result in a fire or electric shock. Never spill liquid of any kind onto or into the product.
- To avoid damage of internal components and to prevent battery leakage, do not place the product on a vibrating surface.

Using electrical power

- This product should be operated from the type of power indicated on the marking label. If you are not sure of the type of power available, consult your dealer or local power company.
- Do not allow anything to rest on the power cord. Do not locate this product where people will walk on the cord.
- If an extension cord is used with this product, make sure that the total ampere rating of the equipment plugged into the extension cord does not exceed the extension cord ampere rating. Also, make sure that the total rating of all products plugged into the wall outlet does not exceed the fuse rating.
- Do not overload a power outlet, strip or receptacle by plugging in too many devices. The overall system load must not exceed 80% of the branch

circuit rating. If power strips are used, the load should not exceed 80% of the power strip's input rating.

- This product's AC adapter is equipped with a three-wire grounded plug. The plug only fits in a grounded power outlet. Make sure the power outlet is properly grounded before inserting the AC adapter plug. Do not insert the plug into a non-grounded power outlet. Contact your electrician for details.



.....
Warning! The grounding pin is a safety feature. Using a power outlet that is not properly grounded may result in electric shock and/or injury.



.....
Note: The grounding pin also provides good protection from unexpected noise produced by other nearby electrical devices that may interfere with the performance of this product.

- Use the product only with the supplied power supply cord set. If you need to replace the power cord set, make sure that the new power cord meets the following requirements: detachable type, UL listed/CSA certified, type SPT-2, rated 7 A 125 V minimum, VDE approved or its equivalent, 4.6 meters (15 feet) maximum length.

Product servicing

Do not attempt to service this product yourself, as opening or removing covers may expose you to dangerous voltage points or other risks. Refer all servicing to qualified service personnel.

Unplug this product from the wall outlet and refer servicing to qualified service personnel when:

- the power cord or plug is damaged, cut or frayed
- liquid was spilled into the product
- the product was exposed to rain or water
- the product has been dropped or the case has been damaged
- the product exhibits a distinct change in performance, indicating a need for service
- the product does not operate normally after following the operating instructions



.....
Note: Adjust only those controls that are covered by the operating instructions, since improper adjustment of other controls may result in damage and will often require extensive work by a qualified technician to restore the product to normal condition.

Replacing the battery pack

The notebook uses lithium batteries. Replace the battery with the same type as that which came bundled with your product. Use of another battery may present a risk of fire or explosion.



Warning! Batteries may explode if not handled properly. Do not disassemble or dispose of them in fire. Keep them away from children. Follow local regulations when disposing of used batteries.

Telephone line safety

- Disconnect all telephone lines from the equipment when not in use and/or before servicing.
- To avoid the remote risk of electric shock from lightning, do not connect the telephone line to this equipment during lightning or thunderstorms.

Disposal instructions

Do not throw this electronic device into the trash when discarding. To minimize pollution and ensure utmost protection of the global environment, please recycle. For more information on the Waste from Electrical and Electronics Equipment (WEEE) regulations, visit <http://global.acer.com/about/sustainability.htm>.



Mercury advisory

For projectors or electronic products containing an LCD/CRT monitor or display: Lamp(s) inside this product contain mercury and must be recycled or disposed of according to local, state or federal laws. For more information, contact the Electronic Industries Alliance at www.eiae.org. For lamp-specific disposal information, check www.lamprecycle.org.



Tips and information for comfortable use

Computer users may complain of eyestrain and headaches after prolonged use. Users are also at risk of physical injury after long hours of working in front of a computer. Long work periods, bad posture, poor work habits, stress, inadequate working conditions, personal health and other factors greatly increase the risk of physical injury.

Incorrect computer usage may lead to carpal tunnel syndrome, tendonitis, tenosynovitis or other musculoskeletal disorders. The following symptoms may appear in the hands, wrists, arms, shoulders, neck or back:

- numbness, or a burning or tingling sensation
- aching, soreness or tenderness
- pain, swelling or throbbing
- stiffness or tightness
- coldness or weakness

If you have these symptoms, or any other recurring or persistent discomfort and/or pain related to computer use, consult a physician immediately and inform your company's health and safety department.

The following section provides tips for more comfortable computer use.

Finding your comfort zone

Find your comfort zone by adjusting the viewing angle of the monitor, using a footrest, or raising your sitting height to achieve maximum comfort. Observe the following tips:

- refrain from staying too long in one fixed posture
- avoid slouching forward and/or leaning backward
- stand up and walk around regularly to remove the strain on your leg muscles
- take short rests to relax your neck and shoulders
- avoid tensing your muscles or shrugging your shoulders
- install the external display, keyboard and mouse properly and within comfortable reach
- if you view your monitor more than your documents, place the display at the center of your desk to minimize neck strain

Taking care of your vision

Long viewing hours, wearing incorrect glasses or contact lenses, glare, excessive room lighting, poorly focused screens, very small typefaces and low-contrast displays could stress your eyes. The following sections provide suggestions on how to reduce eyestrain.

Eyes

- Rest your eyes frequently.
- Give your eyes regular breaks by looking away from the monitor and focusing on a distant point.
- Blink frequently to keep your eyes from drying out.

Display

- Keep your display clean.
- Keep your head at a higher level than the top edge of the display so your eyes point downward when looking at the middle of the display.
- Adjust the display brightness and/or contrast to a comfortable level for enhanced text readability and graphics clarity.
- Eliminate glare and reflections by:
 - placing your display in such a way that the side faces the window or any light source
 - minimizing room light by using drapes, shades or blinds
 - using a task light
 - changing the display's viewing angle
 - using a glare-reduction filter
 - using a display visor, such as a piece of cardboard extended from the display's top front edge
- Avoid adjusting your display to an awkward viewing angle.
- Avoid looking at bright light sources, such as open windows, for extended periods of time.

Developing good work habits

Develop the following work habits to make your computer use more relaxing and productive:

- Take short breaks regularly and often.
- Perform some stretching exercises.
- Breathe fresh air as often as possible.
- Exercise regularly and maintain a healthy body.



.....

Warning! We do not recommend using the computer on a couch or bed. If this is unavoidable, work for only short periods, take breaks regularly, and do some stretching exercises.



.....

Note: For more information, please refer to "Regulations and safety notices" on page 89 in the **AcerSystem User's Guide**.

Information for your safety and comfort	i
Safety instructions	i
Disposal instructions	iii
Tips and information for comfortable use	iv
Empowering Technology	1
Acer Empowering Technology	3
Empowering Technology password	3
Acer eSettings Management	4
Acer eLock Management	5
Acer eDataSecurity Management	6
Acer ePerformance Management	8
Acer eAcoustics Management	9
Using Acer eAcoustics Management	9
Acer eAcoustics Management Main Page	10
Acer eRecovery Management	11
1 First things first	13
Specifications	15
Package contents	17
Accessing the User's Guide	17
2 System tour	19
Features	21
Performance	21
Multimedia	21
Connectivity	21
Front panel	22
Rear panel	24
Keyboard	27
Internet/Email/Search keys	28
Multimedia keys	28
Volume control/mute keys	29
Lock keys	29
Cursor keys	30
Windows keys	30
Function keys	31
Palm rest	31

Contents

Optical drive	32
Taking care of your CDs and DVDs	35
Hard disk	35
3 Setting up your computer	37
Arranging a comfortable work area	39
Adjusting your chair	39
Positioning your PC	39
Positioning your monitor	40
Positioning your keyboard	40
Positioning your mouse	40
Connecting peripherals	41
Connecting your mouse and keyboard	41
USB interface	41
PS/2 interface	41
Connecting a monitor	42
Connecting the power cable	43
Turning on your computer	44
Turning off your computer	44
Connecting options	45
Connecting your printer	45
Connecting the modem (optional)	46
Connecting to the network	46
Connecting multimedia devices	47
Connecting USB devices	49
4 Upgrading your computer	51
Installation precautions	53
ESD precautions	53
Preinstallation instructions	53
Post-installation instructions	54
Opening your Veriton 5900Pro	55
To remove the computer cover	55
To replace the computer cover	55
Opening your Veriton 6900Pro/7900Pro	56
To remove the side panel	56
To replace the side panel	57
Upgrading your computer	58
Installing additional memory	58

To remove a DDR2 DIMM	58
To install a DDR2 DIMM	59
To reconfigure your computer	60
Replacing the Veriton 5900Pro's hard disk	60
Installing an expansion card	60
Replacing the Veriton 6900Pro/7900Pro's hard disk	61
Installing an expansion card	63
5 System utilities	65
Adobe Reader	67
Norton AntiVirus (for selected models)	68
NTI CD&DVD-Maker	
(for models with CD or DVD Burner)	69
PowerDVD (for models with DVD)	71
How do I open and watch a DVD?	71
BIOS utility	72
Reinstalling programs	72
Recovering your system	73
Using backup (Windows XP only)	78
How do I back up files from my hard drive?	78
Disk defragmenter (Windows XP only)	79
How do I defragment my hard drive?	79
6 Frequently asked questions	81
Frequently asked questions	83
Appendix A: Regulations and safety notices	85
ENERGY STAR guidelines compliance	86
FCC notice	86
Modem notices	87
Laser compliance statement	90
Macrovision copyright protection notice	90
Radio device regulatory notice	90
General	90
European Union (EU)	91
The FCC RF safety requirement	91
Canada — Low-power license-exempt radio communication devices (RSS-210)	92

Federal Communications Commission	
Declaration of Conformity	93
Declaration of Conformity for CE marking	94
Index	95

Empowering Technology

Acer's innovative Empowering Technology makes it easy for you to access frequently used functions and manage your new Acer desktop.

Acer Empowering Technology

Acer's innovative Empowering Technology toolbar makes it easy for you to access frequently used functions and manage your new Acer computer. Displayed by default in the upper-right corner of your screen, it features the following handy utilities:

- **Acer eSettings Management** accesses system information and adjusts settings easily.
- **Acer eLock Management** limits access to external storage media and interfaces.
- **Acer eDataSecurity Management** protects data with passwords and advanced encryption algorithms.
- **Acer ePerformance Management** improves system performance by optimizing disk space, memory and registry settings.
- **Acer eAcoustics Management** offers a useful tool to balance your computing power needs with your desired level of quietness.
- **Acer eRecovery Management** backs up and recovers data flexibly, reliably and completely.
- **Acer eProtection Management** provides exceptional protection against viruses and other malware.



For more information, right click on the **Empowering Technology** toolbar, then select the Help or Tutorial function.

Empowering Technology password

Before using Acer eLock Management and Acer eRecovery Management, you must initialize the Empowering Technology password. Right-click on the **Empowering Technology** toolbar and select "**Password Setup**" to do so. If you do not initialize the Empowering Technology password, you will be prompted to do so when running Acer eLock Management or Acer eRecovery Management for the first time.



.....

If you lose your password, there is no method to reset it except by reformatting your computer or taking your computer to an Acer Customer Service Center. Be sure to remember or write down your password.

Acer eSettings Management

Acer eSettings Management allows you to inspect hardware specifications, change BIOS passwords or other Windows settings, and to monitor the system health status.

Acer eSettings Management also:

- Provides a simple graphical user interface for navigation.
- Displays general system status and advanced monitoring for power users on Acer computer.



Acer eLock Management

Acer eLock Management is a security utility that allows you to lock your removable data, optical and floppy drives to ensure that data can't be stolen while your computer is unattended.

- Removable data devices — includes USB disk drives, USB pen drives, USB flash drives, USB MP3 drives, USB memory card readers, IEEE 1394 disk drives and any other removable disk drives that can be mounted as a file system when plugged into the system.
- Optical drive devices — includes any kind of DVD-ROM drives.
- Floppy disk drives — 3.5-inch disks only.
- Interfaces — includes serial port, parallel port, infrared (IR), and Bluetooth.

To activate Acer eLock Management, a password must be set first. Once set, you can apply locks to any of the devices types. Lock(s) will immediately be set without any reboot necessary, and will remain locked after rebooting, until unlocked.



Note: If you lose your password, there is no method to reset it except by reformatting your computer or taking your computer to an Acer Customer Service Center. Be sure to remember or write down your password.

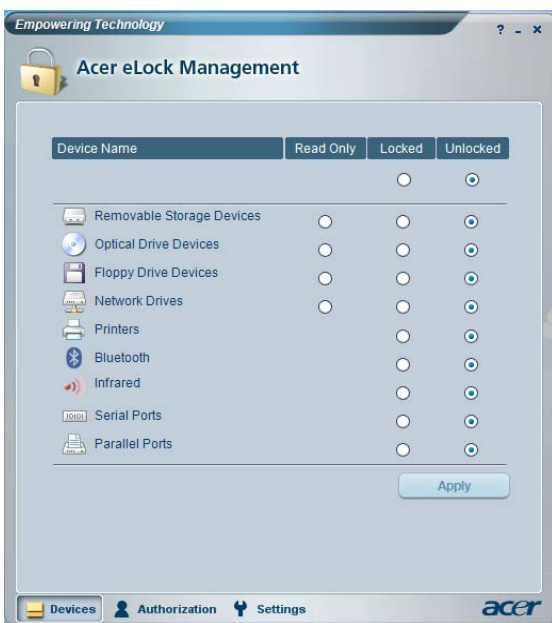

Acer eDataSecurity Management

Acer eDataSecurity Management is a handy file encryption utility that protects your files from being accessed by unauthorized persons. It is conveniently integrated with Windows Explorer as a shell extension for quick and easy data encryption/decryption and also supports on-the-fly file encryption for MSN Messenger and Microsoft Outlook.

The Acer eDataSecurity Management setup wizard will prompt you for a supervisor password and default encryption. This encryption will be used to encrypt files by default, or you can choose to enter your own file-specific password when encrypting a file.



Note: The password used to encrypt a file is the unique key that the system needs to decrypt it. If you lose the password, the supervisor password is the only other key capable of decrypting the file. If you lose both passwords, there will be no way to decrypt your encrypted file! **Be sure to safeguard all related passwords!**

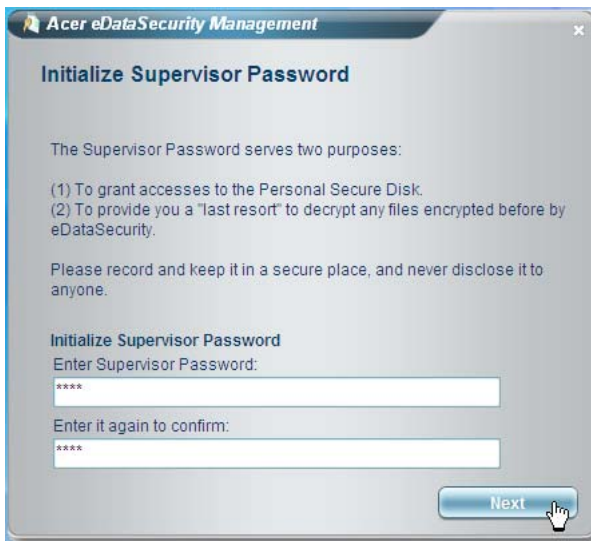

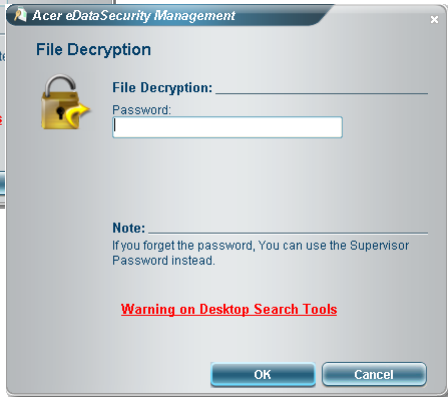

Acer ePerformance Management

Acer ePerformance Management is a system optimization tool that boosts the performance of your Acer computer. It provides an express optimization method to release unused memory and disk space quickly. The user can also enable advanced options for full control over the following options:

- Memory optimization — releases unused memory and check usage.
- Disk optimization — removes unneeded items and files.
- Speed optimization — improves the usability and performance of your Windows XP system.



Acer eAcoustics Management

Acer eAcoustics Management offers you a useful tool to balance your computing power needs with your desired level of quietness. By reducing the processor speed for tasks that require less processing, the CPU and system fans can run slower, thus reducing the amount of sound generated by these components.

Using Acer eAcoustics Management

To launch Acer eAcoustics Management:

- Click on the **Acer eAcoustics Management** icon in the Empowering Technology toolbar shown on your desktop.
- From the Start menu, go to **(All) Programs > Acer Empowering Technology > Acer eAcoustics Management**.



This will open the Acer eAcoustics Management main page.



Acer eAcoustics Management Main Page

Listed on the main page are two options for Acer eAcoustics Management, labeled as Quiet and Professional. Select the mode that suits your working requirements best, and exit the utility to apply the settings.

Quiet

Use this mode for tasks that require low processing power, like word processing, Web browsing, and instant messaging. This mode creates the lowest audio disturbance.

Professional Mode

Use this mode for processing-intensive tasks, when you require full-speed operation.

Acer eRecovery Management

Acer eRecovery Management is a powerful utility that does away with the need for recovery disks provided by the manufacturer. The Acer eRecovery Management utility occupies space in a hidden partition on your system's hard drive. By default, user-created backups are stored on the D:\ drive.

Acer eRecovery Management provides you with:

- Password protection.
- Recovery of applications and drivers.
- Image/data backup:
 - Back up to HDD (set recovery point).
 - Back up to CD/DVD.
- Image/data recovery tools:
 - Recover from a hidden partition (factory defaults).
 - Recover from the HDD (most recent user-defined recovery point).
 - Recover from CD/DVD.

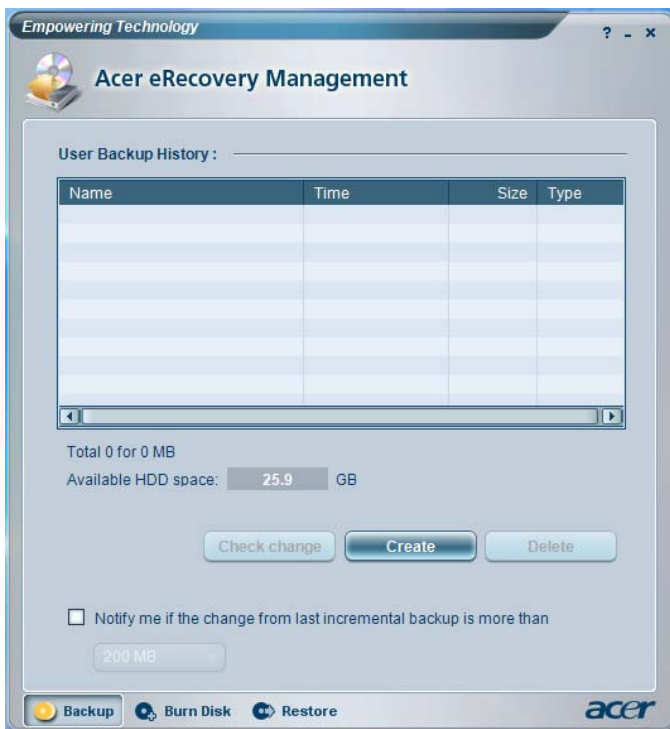



Note: If your computer did not come with a Recovery CD or System CD, please use Acer eRecovery Management's "System backup to optical disk" feature to burn a backup image to CD or DVD. To ensure the best results when recovering your system using a CD or Acer eRecovery Management, detach all peripherals (except the external Acer ODD, if your computer has one), including your Acer ezDock.

1 First things first

This chapter describes the system specifications and contents of your computer package.

Specifications

Operating system	Genuine Microsoft® Windows® XP Professional Edition Genuine Microsoft® Windows® XP Home Edition
Platform	Intel® Celeron® with 533 MHz FSB Intel® Celeron® D with 533 MHz FSB Intel® Pentium® 4 with 533/800 MHz FSB Intel® Pentium® D with 800/1066 MHz FSB
Chipset	Intel® Q965 Express
System memory	Dual channels supported on four DIMMs Supporting up to 4 GB of DDR2 533/667/800 RAM
Drives	Veriton 5900Pro: Two external 5.25" drive bays Three 3.5" drive bays (two internal, one external) Veriton 6900Pro: Two external 5.25" drive bays Six 3.5" drive bays (four internal, two external) Veriton 7900Pro: Three external 5.25" drive bays Six 3.5" drive bays (four internal, two external)
Network interface	Marvell® 88E8056 with Gigabit Ethernet Optional PCI modem
I/O interface	Two PS/2 ports 9-pin serial port 25-pin parallel port Eight USB 2.0 ports Ethernet (RJ-45) port VGA port Six audio jacks
I/O expansion	Two PCI slots PCI Express™ x1 slot PCI Express™ x16 slot

Graphics	Intel® Graphics Media Accelerator 3000 (Intel® GMA 3000) with Dynamic Video Memory Technology (DVMT) support
Audio	Realtek ALC888 with embedded Intel® HDA CODEC
Keyboard	PS/2 or USB multimedia keyboard
Monitor	Choice of Acer CRT or LCD monitors
Security	Lock pad and intrusion alert
Housing	Veriton 5900Pro Series: 370 (H) x 130.2 (W) x 435 (D) mm Veriton 6900Pro Series: 370 (H) x 183 (W) x 450 (D) mm Veriton 7900Pro Series: 450 (H) x 187 (W) x 495 (D) mm
Management software	Acer Empowering Technology Acer eSettings Management Acer eLock Management Acer eDataSecurity Management Acer ePerformance Management Acer eAcoustics Management Acer eRecovery Management Norton AntiVirus™
Industry standards	PC2001 SMBIOS (DMI) 2.3.1 PCI 2.3 WFM 2.0 ACPI 2.0 Microsoft® OnNow ENERGY STAR MacroVision
Power supply	300W
Certification	FCC, CE, C-tick, BSMI, VCCI, CCC, cUL, UL, Nemko, GS (TUV), ENERGY STAR



Note: The specifications listed above are for reference only. The exact configuration of your PC depends on the model purchased.

Package contents

Before you unpack your computer, make sure that you have enough space to set up your computer.

Carefully unpack the carton and remove the contents. If any of the following items are missing or damaged, contact your dealer immediately:

- Veriton series
- Items contained in the accessory box
 - USB or PS/2 keyboard
 - USB or PS/2 mouse
- User's Guide and installation poster
- Other user documentation and third-party software

Accessing the User's Guide

This User's Guide is also available on your computer as an Adobe Acrobat PDF file.

To access the User's Guide (for Windows XP)

- 1 On the Windows XP taskbar, click on the **Start** button then select **Help and Support**.
- 2 On the Help and Support Center home page, double-click the Veriton Series Online icon.

2 System tour

This chapter discusses the features and components of your computer.

Features

Here are just a few of your computer's many features:

Performance

- Intel® Celeron® supporting front side bus (FSB) up to 533 MHz, Intel® Celeron® D supporting FSB up to 533 MHz, Intel® Pentium® 4 supporting FSB up to 533/800 MHz, or Intel® Pentium® D supporting FSB up to 800/1066 MHz
- Intel® Q965 Express chipset
- DDR2 667/800, 4 DIMM slots, expandable to 4 GB dual-channel memory
- Power management function
- CD-ROM, CD-RW, DVD-ROM, DVD/CD-RW combo, DVD-Dual or DVD-Super multi drive
- High-capacity, Enhanced-IDE hard disk

Multimedia

- High-definition audio
- Supporting up to 7.1 surround sound, audio CODEC support for 44.1k/48k/96k/192kHz quality, multiple streams.
- 3D quality audio system via onboard audio controller
- Audio-in/line-in, audio-out/line-out, headphone-out and microphone-in interfaces

Connectivity

- Two PS/2 interfaces for mouse and keyboard
- One serial port (optional 2nd serial port connection)
- One parallel port
- One VGA port
- Eight Universal Serial Bus (USB) 2.0 ports (four on the front; four on the rear panel)
- High-speed V.92, 56K fax/modem (manufacturing option)
- Gigabit Ethernet LAN support with remote wake-up function

Front panel

Your computer's front panel consists of the following:

Veriton 5900Pro

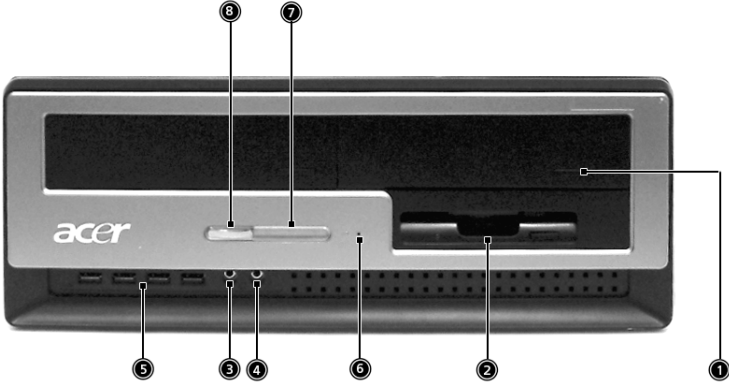



Veriton 6900Pro



Veriton 7900Pro



Icon	Component	Veriton 5900Pro	Veriton 6900Pro/7900Pro
	5.25" drive bay(s)	1	1
	3.5" floppy drive	2	2
	Microphone-in jack (front)	3	3
	Speaker-out/line-out port	4	4
	USB ports	5	5
	Hardware reset button	6	
	Indicators	7	6
	Power button	8	7

Rear panel

Your computer's rear panel consists of the following:

Veriton 5900Pro

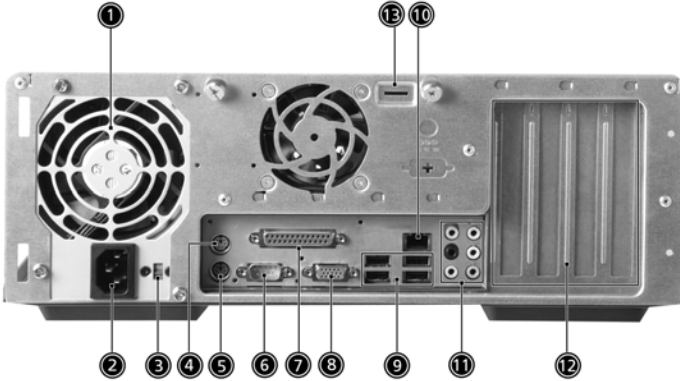



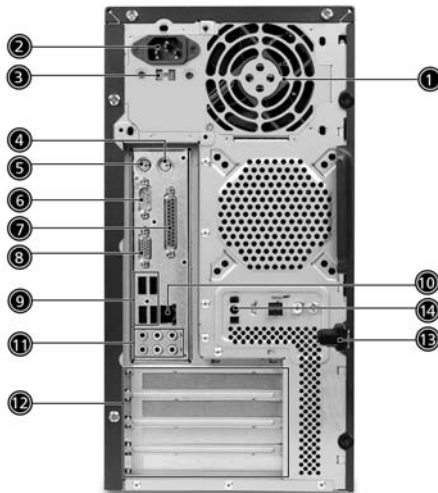

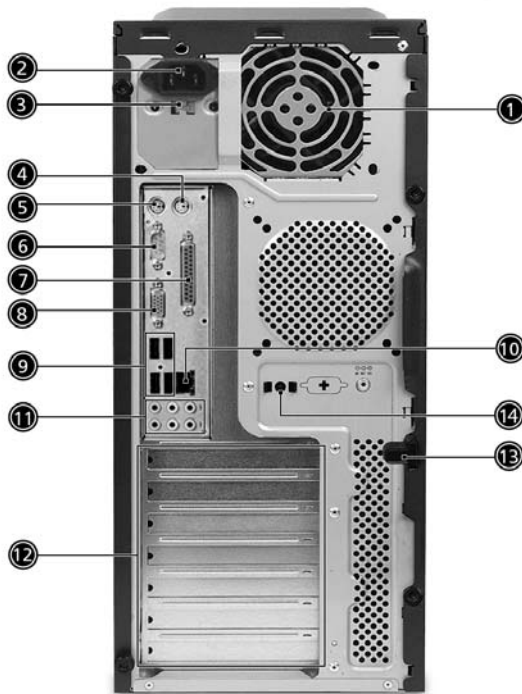

Veriton 6900Pro



Veriton 7900Pro





Icon	Component	Veriton 5900Pro/6900Pro/7900Pro
	Power supply	1
	Power cord socket	2
	Voltage selector switch	3
	PS/2 mouse port	4
	PS/2 keyboard port	5
	Serial port	6
	Parallel/printer port	7
	CRT/LCD monitor port	8
	USB ports	9

Icon	Component	Veriton 5900Pro/6900Pro/7900Pro
	Network port	10
	Audio jack	11
	Expansion slots	12
	Chassis lock pad	13
	Hardware reset button	14*

*. Only for Veriton 6900Pro / Veriton 7900Pro

Audio jacks function table

Color/Use	Headphone	1.1 CH	3.1 CH	5.1 CH	7.1 CH
Blue 	Line-in	Line-in	Line-in	Line-in	Line-in
Green 	Headphone	Line-out	Front	Front	Front
Pink 		Mic-in	Mic-in	Mic-in	Mic-in
Orange				Rear	Rear
Black			Center & woofer	Center & woofer	Center & woofer
Gray					Side



Note: See "Connecting peripherals" on page 41 and "Connecting options" on page 45 for more information.

Keyboard

The keyboard has full-sized keys that include separate cursor keys, two Windows keys, four multimedia keys, and 12 function keys.

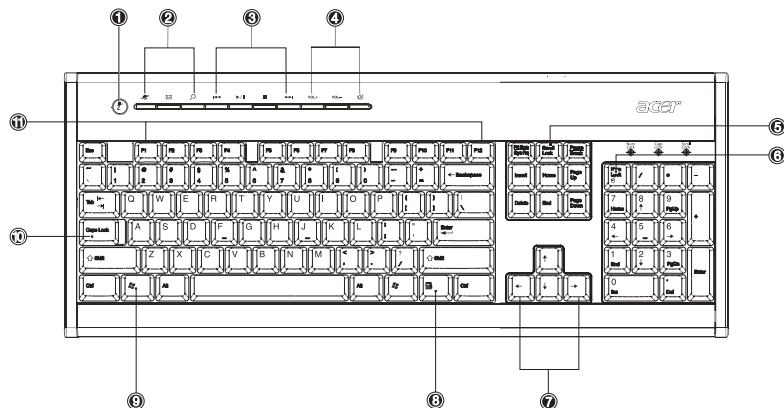

For information on how to connect your keyboard, see **"Connecting your mouse and keyboard"** on page 41.

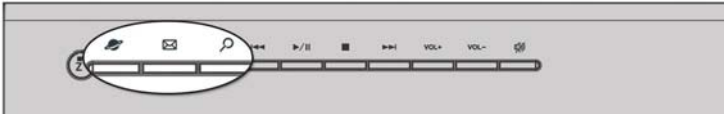

No.	Description	No.	Description
1	Sleep button	2	Internet/Email/Search keys
3	Multimedia keys	4	Volume control/mute keys
5	e (Scroll Lock) key	6	Num Lock key
7	Cursor keys	8	Application key
9	Windows logo key	10	Caps Lock key
11	Function keys		

Internet/Email/Search keys





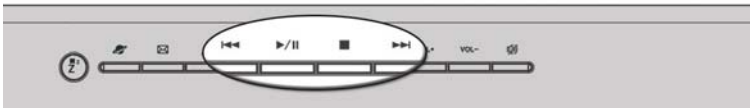

Icon	Key	Description
	Web browser	Launches your current default browser.
	Email	Launches your email application.
	Search	Opens a search window.

Multimedia keys

Allow you to conveniently play, pause, stop, advance or rewind a song or movie using your keyboard.



Icon	Key	Description
	Backward	Press to skip backward to the previous track or video file.
	Play/pause	Press to start playing the audio track or video file. Press again to pause.
	Stop	Press to stop playing the audio track or video file.
	Forward	Press to skip forward to the next track or video file.

Volume control/mute keys

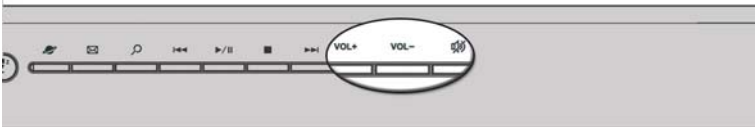

Icon	Key	Description
VOL+	Volume up	Press to increase audio volume.
VOL-	Volume down	Press to decrease audio volume.
	Mute	Toggle sound on/off.

Lock keys

The keyboard has three lock keys which you can toggle on and off to switch between functions.



Lock key	Description
e (Scroll Lock)	When "e" is activated, press to run Acer Empowering Technology. When "Scroll Lock" is activated, the screen moves one line up or down when you press the up arrow or down arrow, respectively.
Num Lock	When activated, the keypad is set to numeric mode, i.e., the keys function as a calculator (complete with arithmetic operators such as +, -, * and /).
Caps Lock	When activated, all alphabetic characters typed appear in uppercase (same function as pressing Shift + <letter>).



Note: Scroll Lock may not work with some applications.

Cursor keys









The cursor keys, also called the arrow keys, let you move the cursor around the screen. They serve the same function as the arrow keys on the numeric keypad when the Num Lock is toggled off.



Windows keys

The keyboard has two keys that perform Windows-specific functions.



Key	Description
Windows key 	Pressed alone, this key has the same effect as clicking on the Windows Start button; it launches the Start menu. It can also be used with other keys to provide a variety of functions:
<  > + <Tab>	Activates the next Taskbar button.
<  > + <E>	Opens the My Computer window.
<  > + <F1>	Opens Help and Support.
<  > + <F>	Opens the Find: All Files dialog box.
<  > + <R>	Opens the Run dialog box.
<  > + <M>	Minimizes all windows.
<Shift> + <  > + <M>	Undoes the minimize all windows action.

Key	Description
Application key 	This key has the same effect as clicking the right mouse button; it opens the application's context menu.

Function keys

The function keys, F1 - F12, let you perform specific functions, depending on the application that uses them.

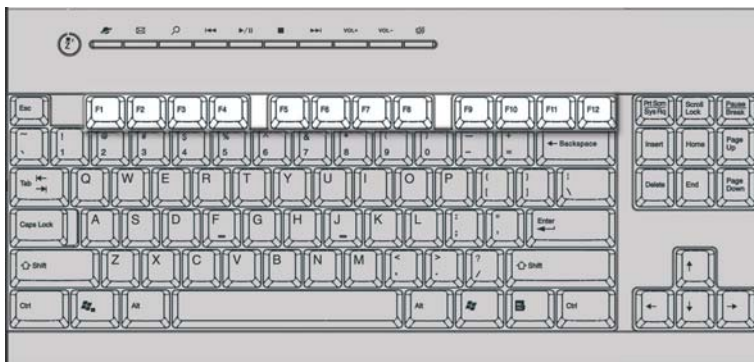

Palm rest

The detachable palm rest provides you with a comfortable place to rest your hands while typing.

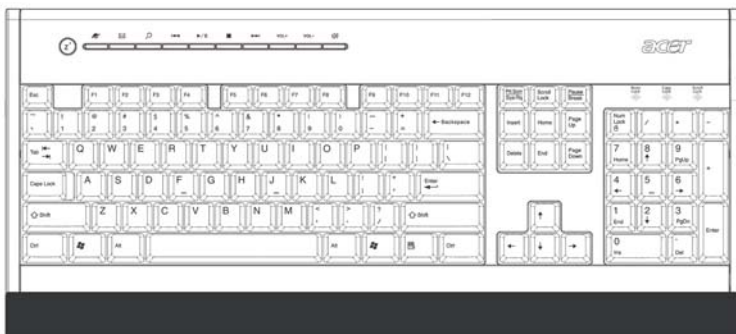

Optical drive

Your computer may come with a CD-ROM, DVD-ROM, DVD/CD-RW combo, DVD-Dual or DVD-Super multi drive. This drive is located on the front panel of your computer. The CD drive allows you to play different types of compact disks (CDs). The DVD drive allows you to play not only old CD-ROMs, CD-I disks, and video CDs, but digital video disks (DVDs) as well. DVD-ROM is a type of disk media with enough storage space for a full-length movie. The CD-RW, DVD-Dual and DVD-super multi drive allow you to record or burn recordable and rewritable disks.

CDs and DVDs, like diskettes, are also compact, lightweight and easy to carry around. However, they are more delicate than diskettes and must be handled with extra care.

To insert a CD or DVD into your computer's CD or DVD drive:

1. Gently push the Eject button located on the front panel.

Veriton 5900Pro



Veriton 6900Pro/7900Pro



2. When the disk tray slides open, place the CD or DVD gently on the tray. Make sure that the label or title side of the disk is facing upward. When holding a disk, hold it by the edges to avoid leaving smudges or fingerprints.

Veriton 5900Pro



Veriton 6900Pro/7900Pro



3. Push the tray and it will close automatically.

Taking care of your CDs and DVDs

- Keep your disk in its case when not in use to avoid scratches or other damage. Any kind of dirt or damage can affect the data on the disk, impair the disk lens reader on the CD or DVD drive, or stop the computer from successfully reading the disk.
- When handling disks, always hold them by the edges to avoid smudges or fingerprints.
- When cleaning disks, use a clean, dust-free cloth and wipe in a straight line from the center to the edge. Do not wipe in a circular motion.
- Clean your CD or DVD drive periodically. You may refer to the Cleaning Kit for instructions. Cleaning kits can be purchased in any computer or electronics shop.

Hard disk

Your computer is pre-installed with a high-capacity Enhanced-IDE (E-IDE) hard disk.

For instructions on how to upgrade or replace your hard disk, see:

"Replacing the Veriton 5900Pro's hard disk" on page 60.

"Replacing the Veriton 6900Pro/7900Pro's hard disk" on page 61.

3 Setting up your computer

This chapter contains step-by-step instructions on how to set up your computer and connect additional peripherals.

Arranging a comfortable work area

Working safely and comfortably begins with the arrangement of your work space and the proper use of equipment. For this reason, it is very important to take time and think about how you are going to arrange your work area. Refer to the diagram on the following page as you set up your system.

Here are some points to consider:

Adjusting your chair

Having the right kind of chair does not necessarily mean you'll be properly supported. It is necessary to adjust your chair to fit your body. Proper body posture will make you more comfortable and productive.

- Avoid tilting your chair. If you have a chair that tilts, lock the tilt knobs so that your chair will not tilt forward or backward while you are using your computer.
- Adjust your chair height in such a way that you can sit on it with your thighs parallel to the floor and your feet resting flat on the floor.
- Rest your body on the chair back. Your torso works harder to maintain balance if you do not rest your body on the chair back.

Positioning your PC

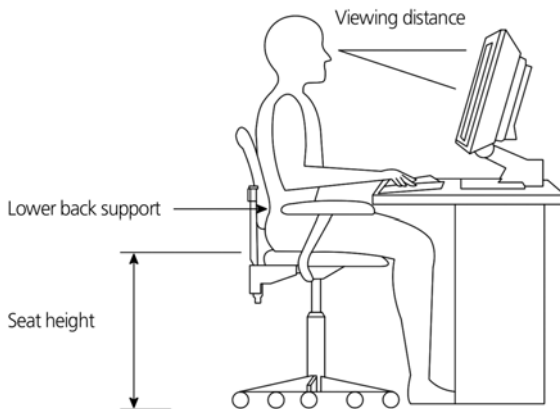

Take note of the following when selecting a location for your computer:

- Do not put your computer near any equipment that might cause electromagnetic or radio frequency interference, such as radio transmitters, televisions, copy machines or heating and air-conditioning equipment.
- Avoid dusty areas and extremes of temperature and humidity.
- You may place your computer beside your desk or under your table, as long as it does not block the space you need for working and moving.

Positioning your monitor

Place your monitor at a comfortable viewing distance, usually 50 to 60 cm away. Adjust the display in such a way that the top of the screen is at or slightly below eye level.

Positioning your keyboard

The location of the keyboard is a very important factor for your posture. Placing it too far away will make your body lean forward, forcing you to sit in an unnatural position. Placing it too high will add tension to your shoulder muscles.

- The keyboard should be placed just above your lap. Adjust the keyboard height by flipping the folding stands located under the keyboard.
- Keep your lower arms parallel to the floor as you type. Your upper arms and shoulders should be relaxed. Then try typing with a light touch. If you feel any shoulder or neck strain, stop for a while and check your posture.
- Position your keyboard in front of your monitor. Putting your keyboard beside your monitor will make you turn your head while you type which could add tension to your neck muscles.

Positioning your mouse

- The mouse should be placed on the same surface as your keyboard so that you can reach it with ease.
- Adjust its position to allow enough space for movement without making you stretch or lean over.
- Use your arm to move the mouse. Do not rest your wrist on the table when moving the mouse.

Connecting peripherals

Setting up your computer is easy. For the most part, you only have four things to connect: the mouse, the keyboard, the monitor, and the power cable.



.....

Note: The peripherals shown in the connections below are for your reference only. Actual device models may vary in select countries.

Connecting your mouse and keyboard

USB interface

Plug your USB mouse or keyboard cable into any of the USB ports  located on the front and rear panels of your computer.

PS/2 interface

Plug the PS/2 mouse and keyboard cable into the PS/2 keyboard port (purple port) and mouse port (green port) located on the rear panel of your computer.



Connecting a monitor

To connect a monitor, simply plug the monitor cable into the monitor port (blue port) located on the rear panel of your computer .



Note: When a VGA card is added to the PCI Express slot, the monitor should be connected to the add-on card and the onboard VGA will be disabled.

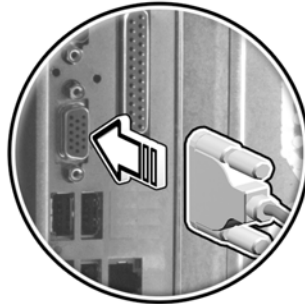

Note: Refer to the monitor manual for additional instructions and information.

Connecting the power cable



Caution: Before you proceed, check the voltage range in your area. Make sure that it matches your computer's voltage setting. If they don't match, change your computer's voltage setting according to your area's voltage range.

Set the voltage selector switch to the voltage range applicable to your area (a). Plug the power cable into the power cable socket located on the rear panel of your computer (b). Then plug the other end of the power cable into a power outlet (c).

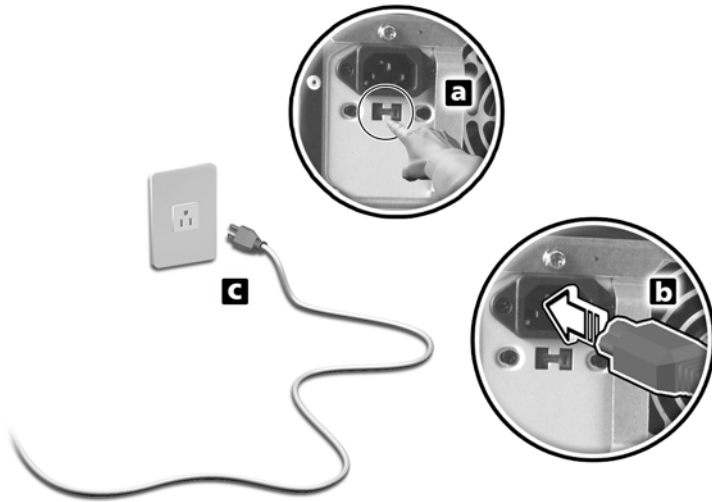

Turning on your computer

After connecting the necessary peripherals and plugging in the power cable, you are now ready to turn the computer on and get to work.

To turn on your computer:

- 1 Turn on all peripherals connected to your computer, such as the monitor, printer, speakers, etc.
- 2 On the front panel of your computer, press the Power button.



Important: Make sure that the power cable is properly plugged into an electrical outlet. If you are using a power strip or an AVR (Auto-Voltage Regulator), make sure that it is plugged in and turned on.

Turning off your computer

To turn off your computer, follow the steps below.

For Windows XP:

- 1 On the Windows XP taskbar, click on the **Start** button, and click **Turn Off Computer**, then click **Turn Off**.
- 2 Turn off all peripherals connected to your computer.

If you cannot shut down your computer normally, press and hold the power button for at least four seconds. Quickly pressing the button may put the computer in suspend mode only.

Connecting options

Connecting your printer

Your computer supports parallel, serial and USB printers.

To connect a parallel printer, plug the printer cable into the parallel port (burgundy port) located on the rear panel of your computer. 





.....
Note: The printer shown below is for your reference only. Actual device model may vary by country.



.....
Note: If you are using a serial printer, connect the printer cable into the serial port located on the rear panel of your computer. In the same manner, connect a USB printer by plugging the printer cable into any of the USB ports located on the front and rear panels.

Connecting the modem (optional)

Set up your modem connection by plugging the telephone line  and handset line  into their corresponding ports on the rear panel of your computer.

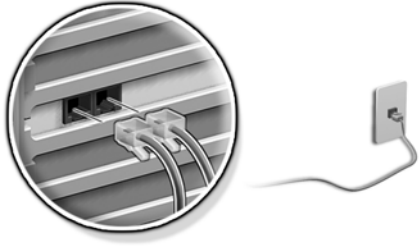

Connecting to the network

You can connect your computer to a Local Area Network (LAN) using a network cable. To do so, simply plug the network cable into the network port  on the rear panel of your computer.

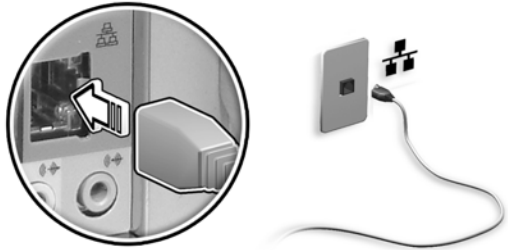

Note: Consult your network system administrator or operating system manual for information on how to configure your network setup.

Connecting multimedia devices

You can connect multimedia devices such as microphones, earphones or headphones, external speakers and audio line-in devices. These devices will let you take advantage of your computer's multimedia features.



Note: The multimedia devices shown below are for reference only. Actual device models may vary in select countries.

Plug the devices in as follows:

- Microphone: Connects to the Microphone-in jacks  (pink jacks) located on the front and rear panels of your computer.

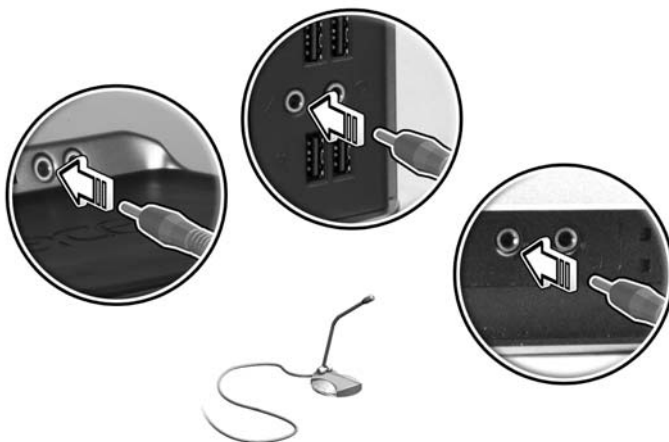

Note: For information on how to configure multimedia devices, consult the documentation that came with each device.

- Earphones, headphones: Connect to the headphone jack  located on the front panel of your computer.



Note: To adjust the headphone volume, use the volume control buttons on the keyboard. You can also adjust the volume by using the volume icon on the taskbar at the bottom of your screen.

- External speakers: Connect to the audio-out/line-out jack  (lime-green jack) located on the rear panel of your computer.

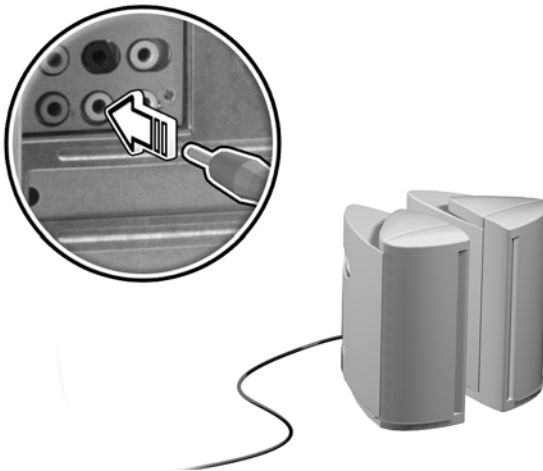

- Audio line-in device: Connects to the audio-in/line-in jack  (light blue jack) located on the rear panel of your computer

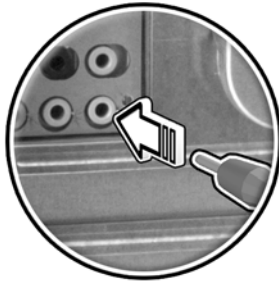

Connecting USB devices

Universal Serial Bus (USB) is a serial bus design capable of cascading peripherals such as a digital camera, keyboard, mouse, joystick, scanner, printer and modem. With USB, complex cable connections can be eliminated.

Your computer comes with eight external USB ports: four on the front and four on the rear panel. These ports support USB 2.0 high-performance external devices such as webcams and digital still cameras. They also allow you to connect additional USB devices to your computer without using up its resources.

To connect a USB device, simply plug the device cable into any of the USB ports  (black) located on the front and rear panels of your computer.

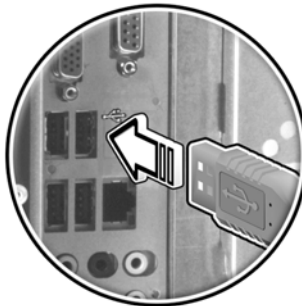



.....

Note: The USB devices shown below are for reference only. Actual device models may vary by geographic region.

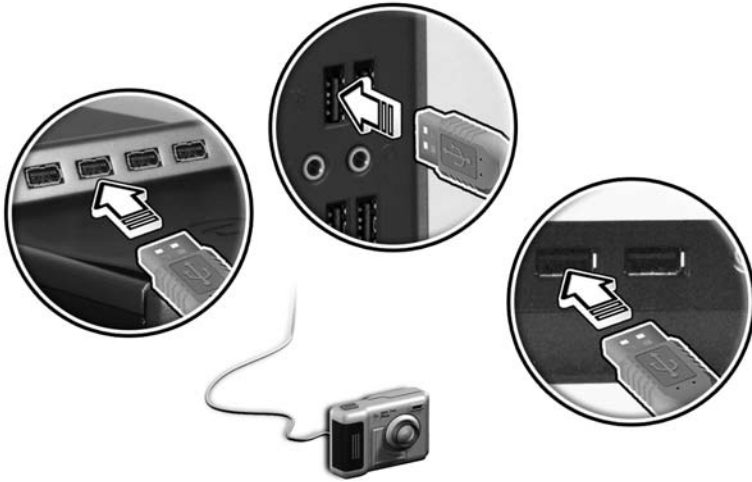

.....

Note: Some USB devices have a built-in USB port which permits you to connect more USB devices.

4 Upgrading your computer

This chapter contains instructions on how to upgrade your computer, and basic information about your system boards that you will find helpful when performing the upgrade process.

Installation precautions

Before you install any computer component, we recommend that you read the following sections. These sections contain important ESD precautions along with preinstallation and post-installation instructions.

ESD precautions

Electrostatic discharge (ESD) can damage your processor, disk drives, expansion boards, and other components. Always observe the following precautions before you install a computer component:

- 1 Do not remove a component from its protective packaging until you are ready to install it.
- 2 Wear a wrist grounding strap and attach it to a metal part of the computer before handling components. If a wrist strap is not available, maintain contact with the computer throughout any procedure requiring ESD protection.

Preinstallation instructions

Always observe the following before you install any component:

- 1 Turn off your computer and all the peripherals connected to it before opening it. Then unplug all cables from the power outlets.
- 2 Open your computer according to the instructions on page 53.
- 3 Follow the ESD precautions described above before handling a computer component.
- 4 Remove any expansion boards or peripherals that block access to the DIMM sockets or component connectors.
- 5 See the following sections for specific instructions on the component you wish to install.



.....

Warning! Not turning off the computer properly before you start installing the components may cause serious damage. Do not attempt the procedures described in the following sections unless you are a qualified service technician.

Post-installation instructions

Observe the following after installing a computer component:

- 1 See to it that the components are installed according to the step-by-step instructions in their respective sections.
- 2 Replace any expansion boards or peripherals that you removed earlier.
- 3 Replace the side panels.
- 4 Connect the necessary cables and turn on your computer.

Opening your Veriton 5900Pro



.....

Caution! Before you proceed, make sure that you have turned off your computer and all peripherals connected to it. Read the **"Preinstallation instructions" on page 53.**

You need to open your computer before you can install additional components. See the following section for instructions:

To remove the computer cover

- 1 Turn off your computer and unplug all cables.
- 2 Place your computer on a flat, steady surface.
- 3 Turn the thumbscrews counterclockwise with your fingers to release the cover.
 - a Hold the cover with both hands.
 - b Slide it back about an inch and then gently lift it upward to detach it.



To replace the computer cover

- 1 Align the cover to the housing frame and then push it in to slide it back into place.
- 2 Secure the cover with the thumbscrews you released earlier.

Opening your Veriton 6900Pro/ 7900Pro



Caution! Before you proceed, make sure that you have turned off your computer and all peripherals connected to it. Read the **"Preinstallation instructions"** on page 53.

You need to open your computer before you can install additional components. See the following section for instructions:

To remove the side panel

- 1 Turn off your computer and unplug all cables.
- 2 Place your computer on a flat, steady surface.
- 3 Turn the screws counterclockwise with your fingers to release the cover.
- 4 Hold right panel (from rear view) with both hands. Slide it back about an inch and then gently pull it outward to detach it.

Veriton 6900Pro



Veriton 7900Pro



To replace the side panel

- 1 Align the side panel's hinges to the housing frame and then push it in to slide it back into place.
- 2 Secure the side panels with the two screws.

Upgrading your computer

Certain components of your computer are upgradeable, such as the memory, the hard disk, the CPU and the expansion cards. You need to observe the **"Installation precautions" on page 53** when installing or removing a computer component. However, for safety purposes, we do not recommend that you perform these upgrades yourself. If you want to replace or upgrade any of these components, contact your dealer or a qualified service technician for assistance.



Note: The mainboard model shown in the following figures may not be exactly the same as the one found in your computer.

Installing additional memory

The four 240-pin sockets on the mainboard support Double Data Rate 2 (DDR2) Synchronous Dynamic Random Access Memory (SDRAM)-type DIMMs. You may install 128 MB, 256 MB, 512 MB or 1 GB DIMMs for a maximum memory capacity of 4 GB. (see note)

The DDR2 DIMMs require 1.8 volts. You can install PC2 3200/DDR2 400, or PC2 4200/DDR2 533 modules in the DDR2 DIMM sockets. Contact your dealer for qualified DIMM vendors.

Each DDR2 DIMM socket is independent from the other. This independence allows you to install DDR2 DIMMs with different capacities to form different configurations.



Note: DDR2 667/800, 4 DIMM slots, expandable to 4 GB dual-channel memory

To remove a DDR2 DIMM



Note: The DDR2 DIMM has only one notch located toward the center of the module.

- 1 Remove the side panel.
- 2 Locate the DDR2 DIMM socket on the mainboard.

- 3 Press the holding clips on both sides of the DDR2 DIMM socket outward to release the DDR2 DIMM (a). Gently pull the DDR2 DIMM out of the socket (b).

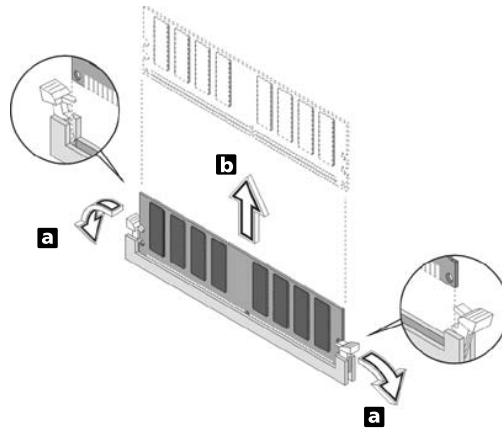

To install a DDR2 DIMM

- 1 Locate the DDR2 DIMM socket on the mainboard.
- 2 Align the DDR2 DIMM with the socket (a). Press the DDR2 DIMM into the socket until the clips lock onto the DDR2 DIMM (b).

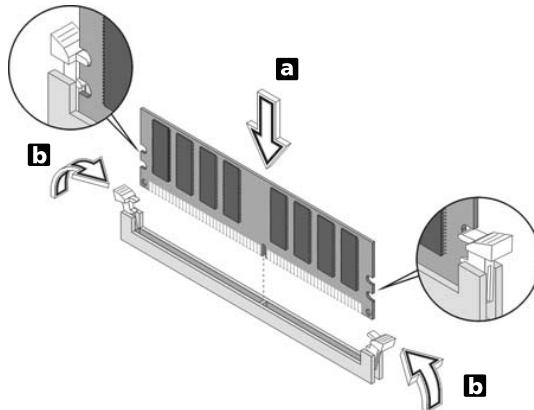

Note: The DDR2 DIMM sockets are slotted to ensure proper installation. If you insert a DDR2 DIMM but it does not fit easily

into the socket, turn the DDR2 DIMM around and try to insert it again.

To reconfigure your computer

Your computer automatically detects the amount of memory installed. Run the BIOS utility to view the new value for total system memory and make a note of it.

Replacing the Veriton 5900Pro's hard disk

Follow these steps to replace your computer's hard disk:

- 1 Remove the computer cover.
- 2 Detach all cables connected to the hard disk and pull the hard disk out.
- 3 Remove the drive rails that hold the hard disk to the disk frame and detach the hard disk. Set the drive rails aside.
- 4 Insert the new hard disk into the frame and secure it with drive rails.
- 5 Reattach all cables to the new hard disk.



.....

Note: Make sure that the other ends of the disk cables are securely connected to their corresponding connectors on the mainboard.

- 6 Reinstall the metal bracket frame to the housing.
- 7 Replace the computer cover.

Installing an expansion card

To install an expansion card:

- 1 Remove the computer cover.
- 2 Locate an empty PCI Express or PCI slot on the mainboard.

- 3 Remove the bracket lock that holds the bracket to the computer. Save the lock.

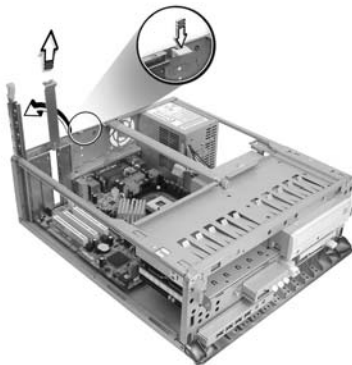

- 4 Pull out the bracket on the housing opposite the selected empty slot.
- 5 Remove the expansion card from its protective packaging.
- 6 Align the card in the empty bracket and then insert it into the slot. Make sure that the card is properly seated.
- 7 Secure the card to your computer with the bracket lock you removed earlier.

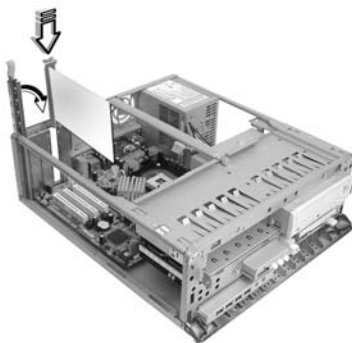

- 8 Replace the computer cover.

When you turn on the computer, BIOS automatically detects and assigns resources to the newly installed devices.

Replacing the Veriton 6900Pro/7900Pro's hard disk

Follow these steps to replace your computer's hard disk:

- 1 Remove the side panel.
- 2 Detach the power and hard disk cables from the hard disk(a). Detach the hard disk from the drive frame (b).

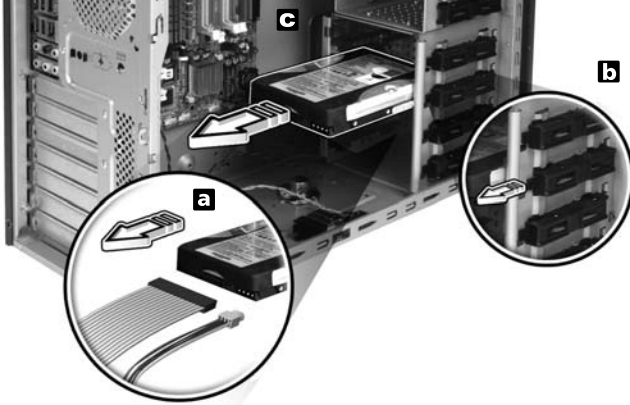

- 3 Insert the new hard disk into the frame (a). Connect the power and hard disk cables to the new hard disk (b).

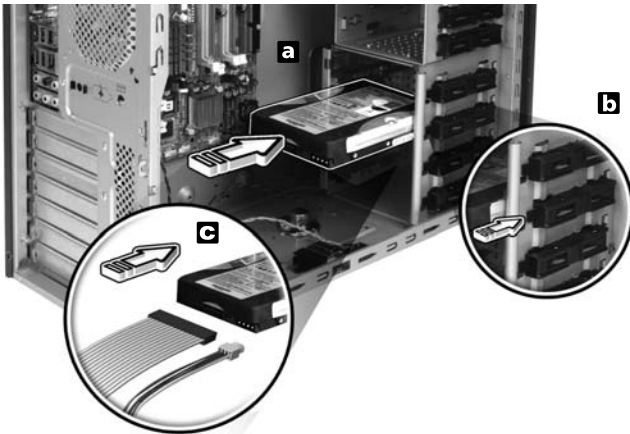

Note: Make sure that the other ends of the disk cables are securely connected to their corresponding connectors on the mainboard.

- 4 Replace the side panel. See **"To replace the side panel"** on page 57.

Installing an expansion card

To install an expansion card:

- 1 Remove the side panel (see page 56).
- 2 Locate an empty PCI Express or PCI slot on the mainboard.
- 3 Remove the lock that holds the bracket to the computer.
- 4 Pull out the bracket on the housing opposite the selected empty slot.
- 5 Remove the expansion card from its protective packaging.
- 6 Align the card with the empty bracket and then insert it into the slot. Make sure that the card is properly seated.
- 7 Secure the card to your computer with the bracket lock you removed earlier.
- 8 Replace the side panel. See **"To replace the side panel" on page 57**.

When you turn on the computer, BIOS automatically detects and assigns resources to the newly installed devices.

5 System utilities

This chapter describes applications that are preinstalled on your computer.

Depending on the hardware and optional features installed in your computer, your system came bundled with several program utilities designed to streamline your computer's operations. These utilities may include any of the following:

- Adobe Reader
- Norton AntiVirus
- NTI CD-Maker
- PowerDVD
- BIOS utility
- Acer Empowering Technology

If your computer is configured with Microsoft Windows XP, the following utilities can be used to monitor and maintain system health:

- Backup
- Disk Defragmenter

All of the applications that came with your computer are very easy to use. However, if you need more help or information, you may refer to the online help documentation provided in each software application.

Adobe Reader

Adobe Reader is software that lets you view, navigate, browse and print Adobe Portable Document Format (PDF) files on all major computer platforms.



To read a PDF document  you can:

- Simply double click on any file with an icon like that shown above.

or

- 1 On the windows taskbar, click on the **Start** button, highlight Programs, and select Adobe Reader.
- 2 Once the program is running, select Open from the File menu.
- 3 Select the file you wish to view in the Open file browser and click the **Open** button.

For more information about Adobe Reader, you may refer to the Adobe Reader Help menu.

Norton AntiVirus (for selected models)

Norton AntiVirus is an anti-virus software that finds and repairs infected files, and protects against viruses to keep your computer data safe and secure.

How do I check for viruses?

A Full System Scan scans all files on your computer. To perform a system scan:

- 1 Start Norton AntiVirus.

Double click on the **Norton AntiVirus** icon on the desktop or click on the **Start** menu in the Windows taskbar, highlight **Programs**, and select **Norton AntiVirus**.

- 2 In the Norton AntiVirus main window, click **Scans**.

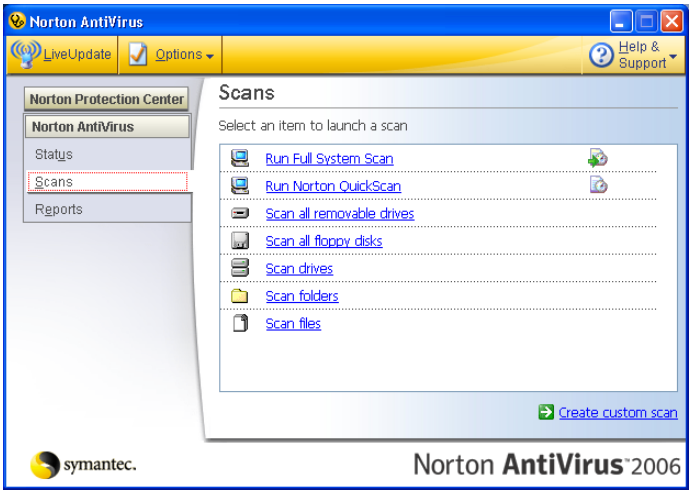

- 3 In the **Scans** panel, click **Run Full System Scan**.

- 4 When the scan is complete, a scan summary appears. Click **Finished**.

You can schedule customized virus scans that run unattended on specific dates and times or at periodic intervals. If you are using the computer when the scheduled scan begins, it runs in the background so that you do not have to stop working.

For more information refer to the Norton AntiVirus Help menu.

NTI CD&DVD-Maker (for models with CD or DVD Burner)

The NTI CD&DVD-Maker is optical disk-recording software that allows you to create and copy audio, data and videos to recordable or rewritable optical disks.

To copy an audio or data disk:

- 1 Click the **Quick Burning** icon  on the desktop.
- 2 Insert the CD you would like to copy into the source drive and a blank disk into the target drive.
- 3 Choose the source and target drives from the pull-down lists.

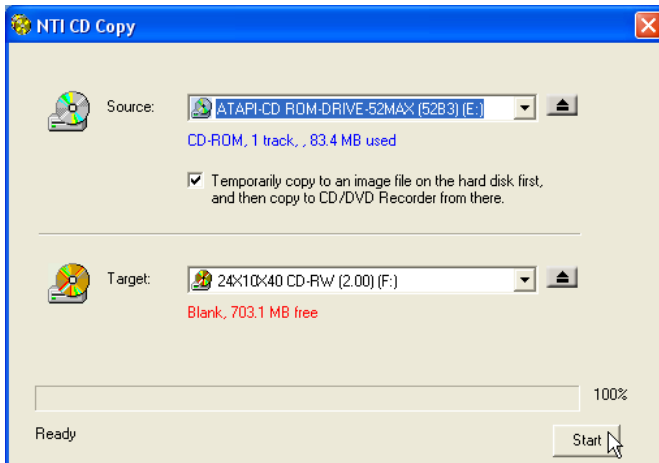

- 4 Click the **Start** button to begin copying.

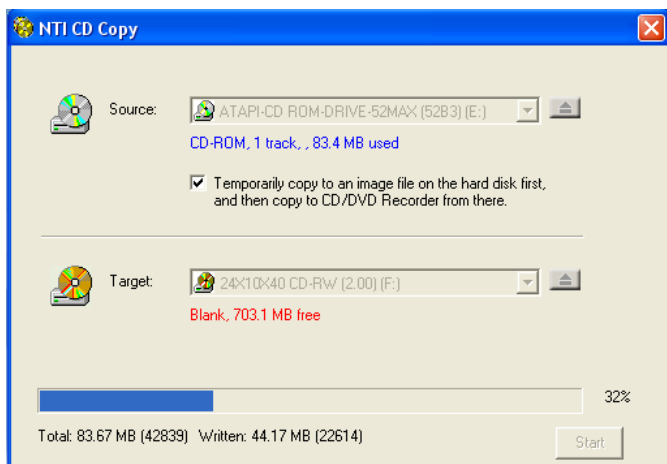

For more information about NTI CD&DVD-Maker and its other features, refer to the NTI CD&DVD-Maker Help menu.

PowerDVD (for models with DVD)

PowerDVD is a high-quality, pure software DVD player that brings high-quality movies and karaoke to your multimedia PC. You can play back high-resolution DVD titles or MPEG-2 files with MPEG-2 video and Dolby Digital (AC-3) audio. PowerDVD provides a complete set of commands for navigation and advanced features such as multi-angle switching, multi-language and multi-subtitle selection, and parental control. It also has the i-Power Internet Enabling feature, which links to online DVD resources via the Power DVD Desktop Portal Page.

How do I open and watch a DVD?

In most cases, when you insert a DVD into your computer's optical drive, PowerDVD will automatically open a viewer window and the control panel and begin playing.



If PowerDVD does not open automatically:

- 1 Click the **Start** button in the taskbar.
- 2 Highlight All Programs.
- 3 Click the **Cyberlink PowerDVD** tab.
- 4 Select PowerDVD.

When PowerDVD opens, simply press the play button  to begin playback.

For more information about Cyberlink PowerDVD and its other features, refer to the PowerDVD Help menu.

BIOS utility

The BIOS utility is a hardware configuration program built into your computer's Basic Input/Output System (BIOS). Since most computers are already properly configured and optimized, there is no need to run this utility. However, if you encounter configuration problems and get the "Run Setup" message, you will need to run this utility.



.....

Note: Before you run BIOS, make sure that you have saved all open files. The computer reboots immediately after you exit Setup.

To run the BIOS utility, press the **Del** key on your keyboard during computer boot up.

Reinstalling programs

If you uninstall one of the preinstalled programs and want to reinstall it, do the following:

- 1 Make sure that the system is turned on.
- 2 Insert the System CD into the CD or DVD drive.
- 3 Select the application that you want to reinstall.
- 4 Follow all onscreen instructions until you finish the installation.

Recovering your system

If your operating system files are lost or damaged, the recovery process will restore your system's original factory default settings or last system backup. Your Veriton series computer includes an OBR(One Button Recovery) button, a feature that makes restoring your system quick and easy.

OBR works from a hidden partition on your hard drive that contains all the information required to restore your system.

There are two modes to recovery your system. One is from system's original settings and another is from system backup. You can press Alt + F10 after the BIOS finishes running the Power On Self Test (POST).



.....

Warning: Initiating the recovery operation while the operating system is running will result in abnormal shutdown and may make your current OS unstable or unusable.

After the POST runs, Press Alt + F10 combine key during BIOS to enter hidden partition. This utility has same password protection with Acer eRecovery. Follow all onscreen instructions.

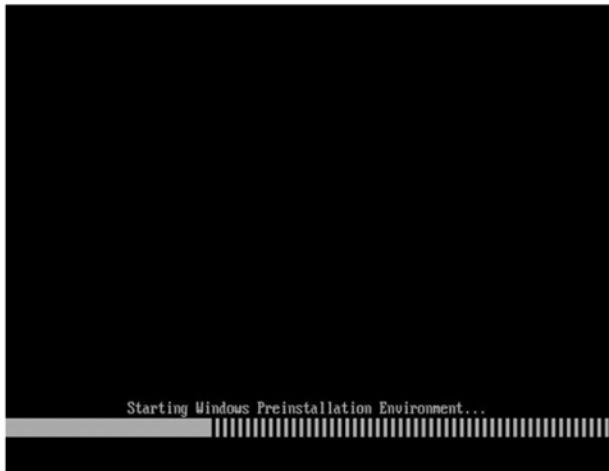

You can also follow the steps below:

- 1 Locate the OBR button.
- 2 Press the button. You can change the password in Acer eRecovery.
 - a If you have not yet backed-up your system.

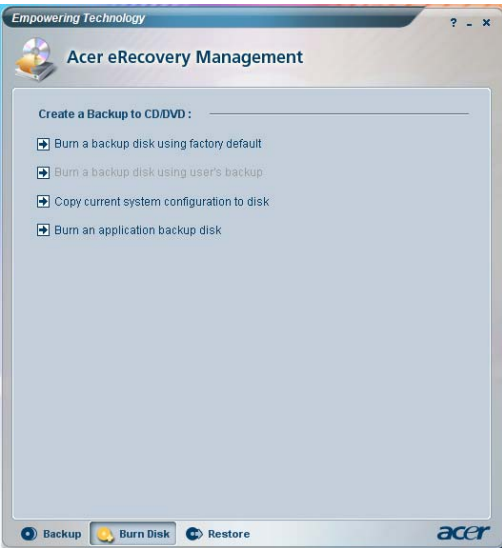
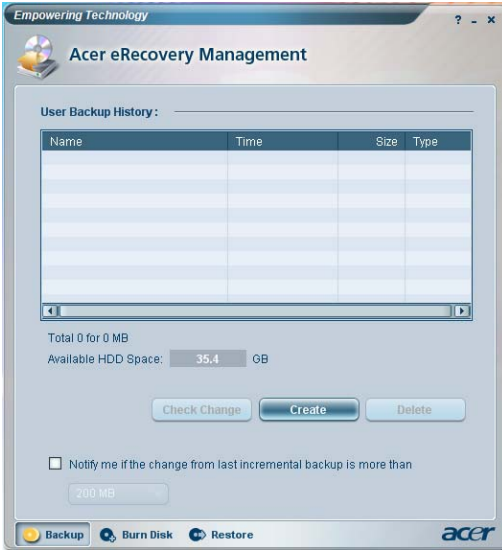

- b If you have previously backed-up your system.

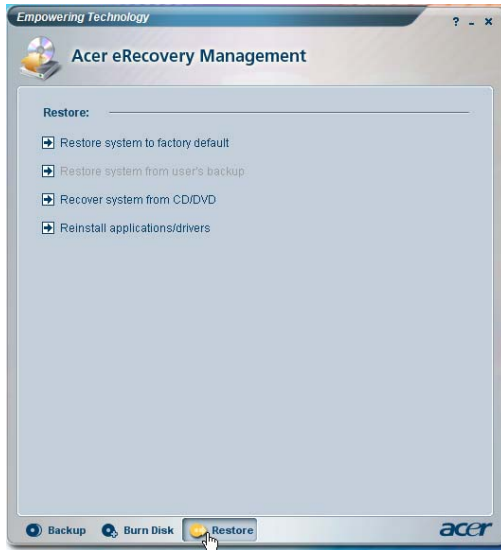

- 3 Select "Recover to Default Settings" to restore your system to the default factory settings. Select "Recover data from last backup" to restore your system to the last system backup.

- 4 If you chose the recovery option, you should see the following screen. Click **OK** to continue.

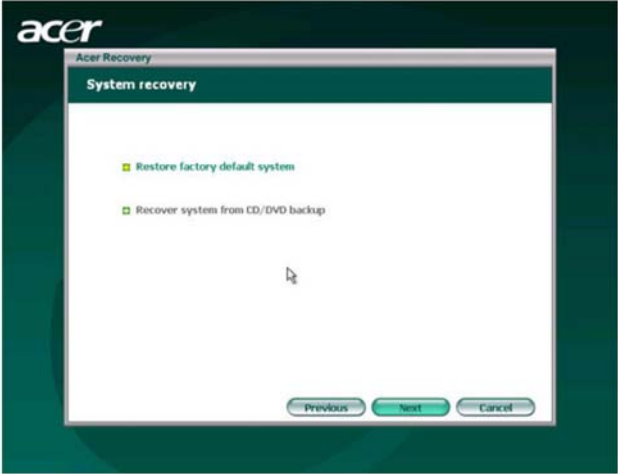

- 5 After 15 seconds the system will reboot and initiate the restore operation.

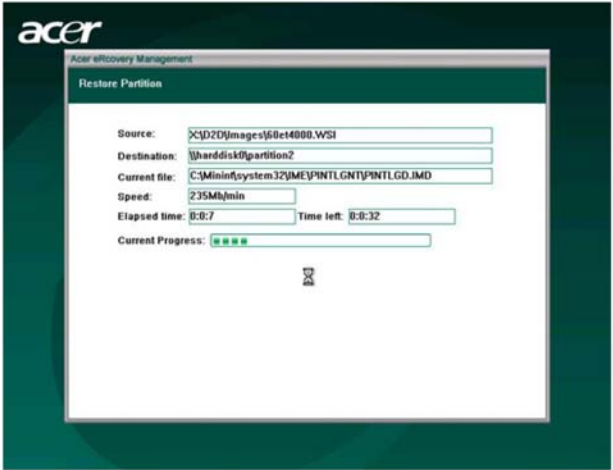

- 6 After the recovery operation finishes the system will reboot. You will be required to go through the setup process again.



Caution! Running the Recovery operation will erase all files previously saved in your computer so make sure to back up your important files before starting the recovery process.



Note : This feature occupies 4GB in a hidden partition on your hard drive.

If you attempt to restore your system using the One Button Recovery feature, and the system DOES NOT respond, contact your local vendor or authorised Acer representative immediately.

Using backup (Windows XP only)

The Backup utility creates copies of information on your hard disk. In the event that the original data on your hard disk is erased or overwritten, or becomes inaccessible because of a hard disk malfunction, you can use the copy to restore your lost or damaged data.

How do I back up files from my hard drive?

To run the Backup utility:

- 1 Click the **Start** button in the taskbar.
- 2 Highlight All Programs
- 3 Click **Accessories**
- 4 Select System Tools
- 5 Click **Backup**

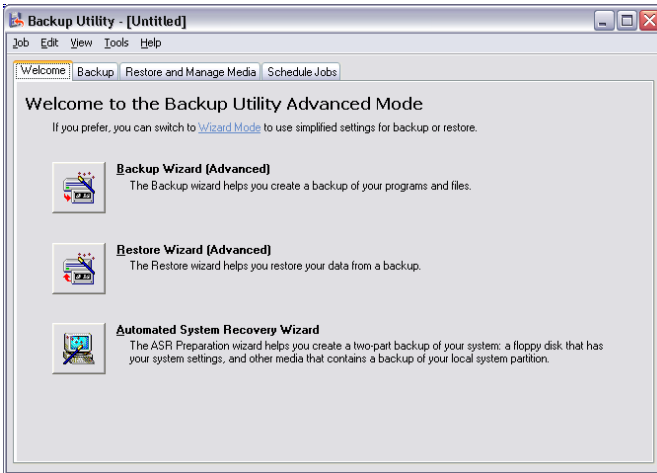

When Backup starts, follow the onscreen instructions to set up your backup profile and schedule.

For more information about Backup, refer to Windows XP help.

Disk defragmenter (Windows XP only)

The disk defragmentation utility consolidates files and folders on your computer's hard disk. This allows your computer to access files and folders and save new data more efficiently. By consolidating your files and folders, the defragmenter also consolidates the volume's free space, making it less likely that new files will be fragmented.

How do I defragment my hard drive?

To run the Disk Defragmenter:

- 1 Click the **Start** button in the taskbar.
- 2 Highlight All Programs
- 3 Click **Accessories**
- 4 Select System Tools
- 5 Click **Disk Defragmenter**

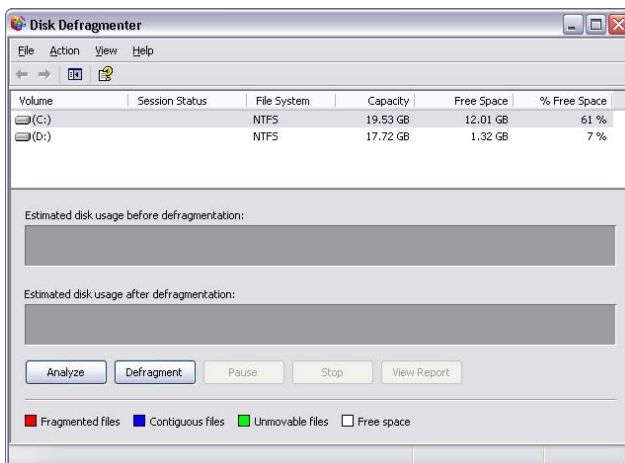

When Disk Defragmenter opens, select a drive/volume and click **Analyze**. The system will quickly examine the volume and determine whether or not it needs to be defragmented.

For more information about Disk Defragmenter, refer to Windows XP help.

6 Frequently asked questions

This chapter tells you what to do in case your computer is not working properly. However, if a more serious problem arises, contact your dealer or the technical support center (www.acersupport.com) for assistance.

Frequently asked questions

The following questions indicate possible situations that may arise during the use of your computer and each is followed by easy answers and solutions.

I pressed the power switch but the system did not boot up.

Check the LED located above the power switch.

If the LED is not lit, no power is being applied to the system. Try the following:

- Check if the voltage selector switch located on the rear panel of the computer is set to the correct voltage.
- Check if you properly plugged the power cable into an electrical outlet.
- If you are using a power strip or AVR, make sure it is plugged in and turned on.

If the LED is lit, check the following:

- Is a nonbootable (nonsystem) diskette in the floppy drive? If yes, remove or replace it with a system diskette and press **<Ctrl> + <Alt> + ** to restart your computer.
- The operating system files may be damaged or missing. Insert the startup disk you created during Windows setup into the floppy drive and press **<Ctrl> + <Alt> + ** to restart your computer. This will automatically diagnose your system and make necessary fixes. However, if the diagnostic utility still reports a problem, then you may have to perform the recovery process to restore your system to its original default factory settings.



.....

Note: For more information about recovering your system, see "**Acer eRecovery Management**" on page 11.

Nothing appears on the screen.

Your computer's power management function automatically blanks the screen to save power. Just press any key to turn the display back on.

If pressing a key does not work, you can restart your computer. If restarting your computer does not work, contact your dealer or technical support center for assistance.

The printer does not work.

Do the following:

- Make sure the printer is connected to a power outlet and that it is turned on.
- Make sure the printer cable is connected securely to the system's parallel or USB port and the corresponding port on the printer. See "**Connecting your printer**" on page 45 for more information.
- For additional information concerning the printer, refer to the printer's documentation.

No sound comes out from the computer.

Check the following:

- The volume may be muted. Look for the Volume icon on the taskbar. If it is crossed-out, click on the icon and deselect the **Mute** option. You can also press the volume control/mute knob on your USB keyboard to toggle from mute to sound on.
- If headphones, earphones or external speakers are connected to the line-out jack of your computer, the internal or built-in speakers are automatically turned off.

System cannot read diskette, hard disk, CD or DVD information.

Check the following:

- Make sure you are using the correct type of disk.
- Make sure the CD or DVD is inserted into the drive correctly.
- Check if the CD or DVD is clean and unscratched.
- Check your drive by using a good (undamaged) disk. If your drive can not read the information on the good disk there may be a problem with the drive. Contact your dealer or technical support center for assistance.

System cannot write data on the hard disk or CD-R/CD-RW.

Check the following:

- Make sure the diskette or hard disk is not write-protected.
- Make sure you are using the correct type of disk or diskette.

Appendix A: Regulations and safety notices

ENERGY STAR guidelines compliance

As an ENERGY STAR partner, Acer Inc. has determined that this product meets the ENERGY STAR guidelines for energy efficiency.

FCC notice

This device has been tested and found to comply with the limits for a Class B digital device pursuant to Part 15 of the FCC rules. These limits are designed to provide reasonable protection against harmful interference in a residential installation. This device generates, uses, and can radiate radio frequency energy and, if not installed and used in accordance with the instructions, may cause harmful interference to radio communications.

However, there is no guarantee that interference will not occur in a particular installation. If this device does cause harmful interference to radio or television reception, which can be determined by turning the device off and on, the user is encouraged to try to correct the interference by one or more of the following measures:

- Reorient or relocate the receiving antenna.
- Increase the separation between the device and receiver.
- Connect the device into an outlet on a circuit different from that to which the receiver is connected.
- Consult the dealer or an experienced radio/television technician for help.

Notice: Shielded cables

All connections to other computing devices must be made using shielded cables to maintain compliance with FCC regulations.

Notice: Peripheral devices

Only peripherals (input/output devices, terminals, printers, etc.) certified to comply with the Class B limits may be attached to this equipment. Operation with non-certified peripherals is likely to result in interference to radio and TV reception.

Caution

Changes or modifications not expressly approved by the manufacturer could void the user's authority, which is granted by the Federal Communications Commission, to operate this computer.

Operation conditions

This device complies with Part 15 of the FCC Rules. Operation is subject to the following two conditions: (1) this device may not cause harmful interference, and (2) this device must accept any interference received, including interference that may cause undesired operation.

Notice: Canadian users

This Class B digital apparatus complies with Canadian ICES-003.

Remarque à l'intention des utilisateurs canadiens

Cet appareil numérique de la classe B est conforme à la norme NMB-003 du Canada.

Declaration of Conformity for EU countries

Hereby, Acer, declares that this PC series is in compliance with the essential requirements and other relevant provisions of Directive 1999/5/EC.

Compliant with Russian regulatory certification



ME61

Modem notices

Notice for USA

This equipment complies with Part 68 of the FCC rules. Located on the modem is a label that contains, among other information, the FCC Registration Number and Ringer Equivalence Number (REN) for this equipment. Upon request, you must provide this information to your telephone company.

If your telephone equipment causes harm to the telephone network, the telephone company may discontinue your service temporarily. If possible, they will notify you in advance. But, if advance notice is not practical, you will be notified as soon as possible. You will also be informed of your right to file a complaint with the FCC.

Your telephone company may make changes in its facilities, equipment, operations, or procedures that could affect the proper functioning of your equipment. If they do, you will be notified in advance to give you an opportunity to maintain uninterrupted telephone service.

If this equipment should fail to operate properly, disconnect the equipment from the phone line to determine if it is causing the problem. If the problem is with the equipment, discontinue use and contact your dealer or vendor.



.....
Caution: To reduce the risk of fire, use only No. 26 AWG or larger UL Listed or CSA Certified Telecommunication Line Cord.

TBR 21

This equipment has been approved [Council Decision 98/482/EC - "TBR 21"] for single terminal connection to the Public Switched Telephone Network (PSTN). However, due to differences between the individual PSTNs provided in different countries, the approval does not, of itself, give an unconditional assurance of successful operation on every PSTN termination point. In the event of problems, you should contact your equipment supplier in the first instance.

List of applicable countries

EU member states as of May 2004 are: Belgium, Denmark, Germany, Greece, Spain, France, Ireland, Italy, Luxembourg, the Netherlands, Austria, Portugal, Finland, Sweden, United Kingdom Estonia, Latvia, Lithuania, Poland, Hungary, Czech Republic, Slovak Republic, Slovenia, Cyprus and Malta. Usage allowed in the countries of European Union, as well as Norway, Switzerland, Iceland and Liechtenstein. This device must be used in strict accordance with the regulations and constraints in the country of use. For further information, please contact local office in the country of use.

Notice for Australia

For safety reasons, only connect headsets with a telecommunications compliance label. This includes customer equipment previously labelled permitted or certified.

Notice for New Zealand

- 1 The grant of a Telepermit for any item of terminal equipment indicates only that Telecom has accepted that the item complies with minimum conditions for connection to its network. It indicates no endorsement of the product by Telecom, nor does it provide any sort of warranty. Above all, it provides no assurance that any item will work correctly in all respects with another item of Telepermitted equipment of a different make or model, nor does it imply that any product is compatible with all of Telecom's network services.
- 2 This equipment is not capable, under all operating conditions, of correct operation at the higher speeds for which it is designed. Telecom will accept no responsibility should difficulties arise in such circumstances.
- 3 Some parameters required for compliance with Telecom's Telepermit requirements are dependent on the equipment (PC) associated with this device. The associated equipment shall be set to operate within the following limits for compliance with Telecom's Specifications:
 - a There shall be no more than 10 call attempts to the same number within any 30 minute period for any single manual call initiation, and
 - b The equipment shall go on-hook for a period of not less than 30 seconds between the end of one attempt and the beginning of the next call attempt.
- 4 Some parameters required for compliance with Telecom's Telepermit requirements are dependent on the equipment (PC) associated with this device. In order to operate within the limits for compliance with Telecom's specifications, the associated equipment shall be set to ensure that automatic calls to different numbers are spaced such that there is not less than 5 seconds between the end of one call attempt and the beginning of another.
- 5 This equipment shall not be set up to make automatic calls to Telecom's 111 Emergency Service.
- 6 This device is equipped with pulse dialing while the Telecom standard is DTMF tone dialing. There is no guarantee that Telecom lines will always continue to support pulse dialing.
- 7 Use of pulse dialing, when this equipment is connected to the same line as other equipment, may give rise to bell tinkle or noise and may also cause a false answer condition. Should such problems occur, the user should NOT contact the telecom Fault Service.
- 8 This equipment may not provide for the effective hand-over of a call to another device connected to the same line.
- 9 Under power failure conditions this appliance may not operate. Please ensure that a separate telephone, not dependent on local power, is available for emergency use.

Laser compliance statement

The CD or DVD drive used with this computer is a laser product.
The CD or DVD drive's classification label (shown below) is located on the drive.

CLASS 1 LASER PRODUCT

CAUTION: INVISIBLE LASER RADIATION WHEN OPEN. AVOID EXPOSURE TO BEAM.

APPAREIL A LASER DE CLASSE 1 PRODUIT

LASERATTENTION: RADIATION DU FAISCEAU LASER INVISIBLE EN CAS D'OUVERTURE. EVITER TOUTE EXPOSITION AUX RAYONS.

LUOKAN 1 LASERLAITE LASER KLASSE 1

VORSICHT: UNSICHTBARE LASERSTRAHLUNG, WENN ABDECKUNG GEÖFFNET NICHT DEM STRAHLL AUSSETZEN

PRODUCTO LÁSER DE LA CLASE I

ADVERTENCIA: RADIACIÓN LÁSER INVISIBLE AL SER ABIERTO. EVITE EXPONERSE A LOS RAYOS.

ADVARSEL: LASERSTRÅLING VEDÅBNING SE IKKE IND I STRÅLEN.

VARO! LAVATTAESSA OLET ALTTINA LASERSÄTEILYLLE.

VARNING: LASERSTRÅLNING NÅR DENNA DEL ÅR ÖPPNAD ÅLÅ TUIJOTA SÄTEESEENSTIRRA EJ IN I STRÅLEN

VARNING: LASERSTRÅLNING NAR DENNA DEL ÅR ÖPPNADSTIRRA EJ IN I STRÅLEN

ADVARSEL: LASERSTRÅLING NAR DEKSEL ÅPNESSTIRR IKKE INN I STRÅLEN

Macrovision copyright protection notice

This product incorporates copyright protection technology that is protected by U.S. patents and other intellectual property rights. Use of this copyright protection technology must be authorized by Macrovision, and is intended for home and other limited viewing uses only unless otherwise authorized by Macrovision. Reverse engineering or disassembly is prohibited.

Radio device regulatory notice



.....

Note: Below regulatory information is for models with wireless LAN and/or Bluetooth only.

General

This product complies with the radio frequency and safety standards of any country or region in which it has been approved for wireless use. Depending on

configurations, this product may or may not contain wireless radio devices (such as wireless LAN and/or Bluetooth modules). Below information is for products with such devices.

European Union (EU)

This device complies with the essential requirements of the European Council Directives listed below:

73/23/EEC Low Voltage Directive

- **EN 60950-1**

89/336/EEC Electromagnetic Compatibility (EMC) Directive

- **EN 55022**
- **EN 55024**
- **EN 61000-3-2/-3**

99/5/EC Radio & Telecommunications Terminal Equipment (R&TTE) Directive

- **Art.3.1a) EN 60950-1**
- **Art.3.1b) EN 301 489 -1/-17**
- **Art.3.2) EN 300 328-2**
- **Art.3.2) EN 301 893 *applies to 5 GHz only**

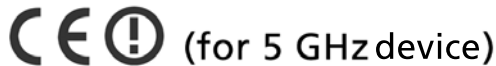

List of applicable countries

EU member states as of May 2004 are: Belgium, Denmark, Germany, Greece, Spain, France, Ireland, Italy, Luxembourg, the Netherlands, Austria, Portugal, Finland, Sweden, United Kingdom Estonia, Latvia, Lithuania, Poland, Hungary, Czech Republic, Slovak Republic, Slovenia, Cyprus and Malta. Usage allowed in the countries of European Union, as well as Norway, Switzerland, Iceland and Liechtenstein. This device must be used in strict accordance with the regulations and constraints in the country of use. For further information, please contact local office in the country of use.

The FCC RF safety requirement

The radiated output power of the wireless LAN Card is far below the FCC radio frequency exposure limits. Nevertheless, the PC series shall be used in such a manner that the potential for human contact during normal operation is minimized as follows:

- 1 This device is restricted to indoor use due to its operation in the 5.15 to 5.25 GHz frequency range. FCC requires this product to be used indoors for the frequency range 5.15 to 5.25 GHz to reduce the potential for harmful interference to co-channel Mobile Satellite systems.
- 2 High power radar are allocated as primary users of the 5.25 to 5.35 GHz and 5.65 to 5.85 GHz bands. These radar stations can cause interference with and/or damage this device.
- 3 An improper installation or unauthorized use may cause harmful interference to radio communications. Also any tampering of the internal antenna will void the FCC certification and your warranty.

Canada — Low-power license-exempt radio communication devices (RSS-210)

- a Common information
Operation is subject to the following two conditions:
 1. This device may not cause interference, and
 2. This device must accept any interference, including interference that may cause undesired operation of the device.
 - b Operation in 2.4 GHz band
To prevent radio interference to the licensed service, this device is intended to be operated indoors and installation outdoors is subject to licensing.
 - c Operation in 5 GHz band
- The device for the band 5150-5250 MHz is only for indoor usage to reduce potential for harmful interference to co-channel Mobile Satellite systems.
 - High power radars are allocated as primary users (meaning they have priority) of 5250-5350 MHz and 5650-5850 MHz and these radars could cause interference and/or damage to LELAN (Licence-Exempt Local Area Network) devices.

Federal Communications Commission Declaration of Conformity

This device complies with Part 15 of the FCC Rules. Operation is subject to the following two conditions: (1) This device may not cause harmful interference, and (2) This device must accept any interference received, including interference that may cause undesired operation.

The following local manufacturer/importer is responsible for this declaration:

Product name:	Personal computer
Model:	Veriton Series
Name of responsible party:	Acer America Corporation
Address of responsible party:	2641 Orchard Parkway San Jose, CA 95134 USA
Contact person:	Mr. Young Kim
Tel:	408-922-2909
Fax:	408-922-2606

Declaration of Conformity for CE marking

Name of manufacturer: Acer Inc.
 Address of manufacturer: 8F, 88, Sec. 1, Hsin Tai Wu Rd.
 Hsichih, Taipei Hsien 221
 Taiwan
 Declares that product: Personal computer
 Model: Veriton Series

Conforms to the EMC Directive 89/336/EEC as attested by conformity with the following harmonised standards:

EN55022:1994 /A2: 1997: Limits and Methods of Measurement of Radio Interference characteristics of Information Technology Equipment

EN55024: 1998/A1: 2001: Information technology equipment — Immunity characteristics — Limits and methods of measurement including:

EN61000-4-2: 1995/A1: 1998/A2: 2001	EN61000-4-6: 1996/A1: 2001
EN61000-4-3: 1996/A1: 1998	EN61000-4-8: 1993/A1: 2001
EN61000-4-4: 1995/A2: 2001	EN61000-4-11: 1994/A1: 2001
EN61000-4-5: 1995/A1: 2001	

EN61000-3-2: 2000: Limits for harmonics current emissions

EN61000-3-3: 1995/A1: 2001: Limits for voltage fluctuations and flicker in low-voltage supply systems

Conforms to the Low Voltage Directive 73/23/EEC as attested by conformity with the following harmonised standard:

EN60950: 2000: Safety of Information Technology Equipment Including electrical business equipment. This equipment has been approved to Council Decision 98/482/EC (CTR21) for pan-European single terminal connection to the Public Switched Telephone Network (PSTN).

We, Acer Inc., hereby declare that the equipment bearing the trade name and model number specified above was tested conforming to the applicable Rules under the most accurate measurement standards possible, and that all the necessary steps have been taken and are in force to assure that production units of the same equipment will continue to comply with the requirements.

Easy Lai
 Easy Lai, Director
 Qualification Center
 Product Assurance

08/01/2006

 Date

Index

- A
 - accessing the online User's Guide 17
 - applications 67
- B
 - BIOS utility 72
- C
 - computer cover
 - remove 55
 - replace 55
 - connecting options
 - multimedia devices 47
 - audio line-in device 49
 - earphones/headphones 48
 - external speakers 47
 - microphone 47
 - network 45, 46
 - printer 45
 - serial mouse 46
 - USB devices 49
- D
 - disk drives
 - CD-ROM/DVD-ROM/CD-RW drive
 - inserting CDs/DVDs 32
 - taking care CDs/DVDs 35
 - hard disk 35
- F
 - features 21
 - connectivity 21
 - multimedia 21
 - performance 21
 - Frequently-asked questions 83
 - blank screen 83
 - no audio 84
 - no sound 84
 - printer not working 84
 - system cannot read disk 84
 - system cannot write to disk 84
 - system did not boot up 83
 - front panel 22
- I
 - internet/suspend key
 - email 28
 - suspend 28
 - web browser 28
- K
 - keyboard 27
- L
 - lock keys
 - Caps Lock 29
 - Num Lock 29
 - Scroll Lock 29
- M
 - multimedia key
 - forward 28
 - play/pause 28
 - stop 28
- N
 - NTI 69
- P
 - PowerDVD 71
- R
 - rear panel 24
 - recovering your system 73
 - remove the side panel 56
- S
 - safety
 - CD or DVD 90
 - FCC notice 86
 - modem notices 87
 - setting up computer 39, 41
 - area 39
 - chair 39
 - connecting peripherals
 - external monitor 42
 - power cable 43
 - keyboard 40
 - monitor 40
 - mouse 40
 - software 67
 - Norton AntiVirus 68
 - system utilities
 - Acrobat Reader 67

- Norton AntiVirus 68
 - NTI CD-Maker 69
 - PowerDVD 71
 - reinstalling programs 72
- T
- turning off computer 44
 - software shutdown 44
 - suspend mode 44
 - turning on computer 44
 - power button 44
- U
- upgrade
 - add memory 58
 - install DDR DIMM 59
 - reconfigure computer 60
 - computer 58
 - install an expansion card 60
 - installation precautions
 - post-installation 54
 - open computer
 - reinstall side panel 57
 - replace components
 - memory 58