

KB9800E

User manual

Electric built-in oven

## Dear Customer

Thank you for choosing one of our high-quality products.

With this appliance you will experience the perfect combination of functional design and cutting edge technology.

Convince yourself that our appliances are engineered to deliver the best performance and control - indeed we are setting the highest standards of excellence.

In addition to this you find environmental and energy saving aspects as an integral part of our products.

To ensure optimal and regular performance of your appliance please read this instruction manual carefully. It will enable you to navigate all processes perfectly and most efficiently. To refer to this manual any time you need to, we recommend you to keep it in a safe place. And please pass it to any future owner of the appliance.

We wish you much joy with your new appliance.

The following symbols are used in this user manual:



Important information concerning your personal safety and information on how to avoid damaging the appliance.



General information and tips



Environmental information

# Contents

Operating instructions	6
<b>Safety information</b>	<b>6</b>
Electrical safety	6
Children's safety	6
Safety during use	6
How to avoid damage to the appliance	7
<b>Description of the appliance</b>	<b>8</b>
General view	8
Control panel	9
Oven layout	9
Accessories Oven	10
<b>Before using for the first time</b>	<b>10</b>
Setting and changing the time	10
Cleaning for the first time	11
Getting to know the appliance	12
<b>Operating the oven</b>	<b>12</b>
The electronic oven controls	12
The display field	12
The control panel	13
Selecting the oven function	14
Changing the oven temperature	14
Thermometer symbol	14
Changing the oven function	15
Switching the oven off	15
Fast Warm Up	15
Oven Functions	16
Inserting the oven shelf and baking tray	16
Grease filter Inserting/Removing the	17
Additional functions	17
Baking and Roasting Programmes	17
Memory function	18
Clock functions	19
Countdown	20
Cook Time	21

End Time	22
Cook Time and End Time combined	23
Other functions	24
Switching off the display	24
Child safety device	25
Button Beep	26
The oven's automatic switch-off	26
<b>Usage, Tables and Tips</b>	<b>26</b>
<hr/>	
Baking	26
General instructions	27
Baking Table	28
Tips on baking	30
Bakes and Gratins Table	31
Frozen Ready Meals Table	31
Roasting	32
Roasting Table	32
Low temperature cooking	34
Low Temperature Cooking Table	34
Single economy grill	35
Grilling Table	35
Rotitherm Roasting	36
Oven function: Rotitherm Roasting	36
Defrosting	36
Defrosting Table	36
Drying	37
Making preserves	37
Preserves table	38
Programmed recipes	39
LEMON SPONGE CAKE 1000 G	39
QUARK MANDARIN SLICE	40
WHITE BREAD 600-800 G	41
ROLLS 40 G EACH (12-16)	42
PIZZA	42
QUICHE LORRAINE	43
POTATO GRATIN	44
FISH FILLET	45
SADDLE OF VEAL	45
LASAGNE	46

ROAST PORK	47
CHICKEN 1200 G	47
<b>Cleaning and care</b>	<b>48</b>
<hr/>	
The outside of the appliance	48
Oven interior	48
Oven interior	49
Oven roof with catalytic self-cleaning surface	49
Accessories	49
Grease filter	50
Side rails	50
Removing the side rails	50
Replacing the side rails	51
Oven lighting	51
Oven door	52
Removing the oven door from its hinges	53
Hanging the oven door back on its hinges	53
<b>What to do if...</b>	<b>54</b>
<hr/>	
<b>Installation instructions</b>	<b>55</b>
<hr/>	
Safety information for the installer	55
<b>Disposal</b>	<b>60</b>
<hr/>	
<b>Guarantee/Customer Service</b>	<b>60</b>
<hr/>	
<b>GREAT BRITAIN &amp; IRELAND</b>	<b>60</b>
<hr/>	
<b>European Guarantee</b>	<b>62</b>
<hr/>	
<b><a href="http://www.electrolux.com">www.electrolux.com</a></b>	<b>63</b>
<hr/>	
<b>Service</b>	<b>65</b>
<hr/>	

Subject to change without notice

# Operating instructions

## Safety information

### Important safety instructions

Read carefully and keep for future use.

### Electrical safety

- This appliance must only be connected by a **qualified installation engineer**.
- In the event of a fault or damage to the appliance: Take the fuses out or switch off.
- **Repairs** to the appliance must **only be carried out by qualified service engineers**. Considerable danger may result from improper repairs. If repairs become necessary, please contact our Customer Care Department or your dealer.

### Children's safety

- Never leave children unsupervised while the appliance is operating.
- This appliance is fitted with a child safety device.

### Safety during use

- This appliance should be used only for normal domestic cooking, roasting and baking of food.
- Be careful if connecting electrical appliances to sockets near to this appliance. Electrical leads must **not** be caught under the hot oven door.
- **Warning: Risk of burns!** The interior surfaces of the oven become very hot during use.
- If you use ingredients containing alcohol in the oven, a slightly flammable mixture of alcohol and air may ensue. In this case, be careful when opening the door. Do not handle any sources of heat, sparks or naked flames when doing so.
- People (including children), who because of their physical, sensory or mental capabilities or their inexperience or ignorance, are not able to use the appliance safely, should not use this appliance without supervision by or instruction from a responsible person.

### Information on acrylamides

According to the latest scientific studies, intensive browning of food, especially in products containing starch, can constitute a health risk due to acrylamides. Therefore we recommend cooking at the lowest possible temperatures and not browning foods too much.

## How to avoid damage to the appliance

- Do not line the oven with aluminium foil and do not place baking trays, pots, etc. on the oven floor, as the heat that builds up will damage the oven enamel.
- Fruit juices dripping from the baking tray will leave stains, which you will not be able to remove. For very moist cakes, use a deep tray.
- Do not put any strain on the oven door when open.
- Never pour water directly into the oven when it is hot. This could cause damage to and discoloration of the enamel.
- Rough handling, especially around the edges of the front panel, can cause the glass to break.
- Do not store any flammable materials inside the oven. These could ignite when the oven is switched on.
- Do not store any moist foods inside the oven. This could cause damage to the enamel.
- Do not leave dishes uncovered in the oven after switching off the cooling fan. Moisture may form inside the oven or on the glass door and also get onto the units.

### Information on the oven enamel

Changes to the colour of the oven's enamel surface as a result of use do not affect the appliance's operation. correct use. They therefore do not constitute a defect in terms of warranty law.

# Description of the appliance

## General view

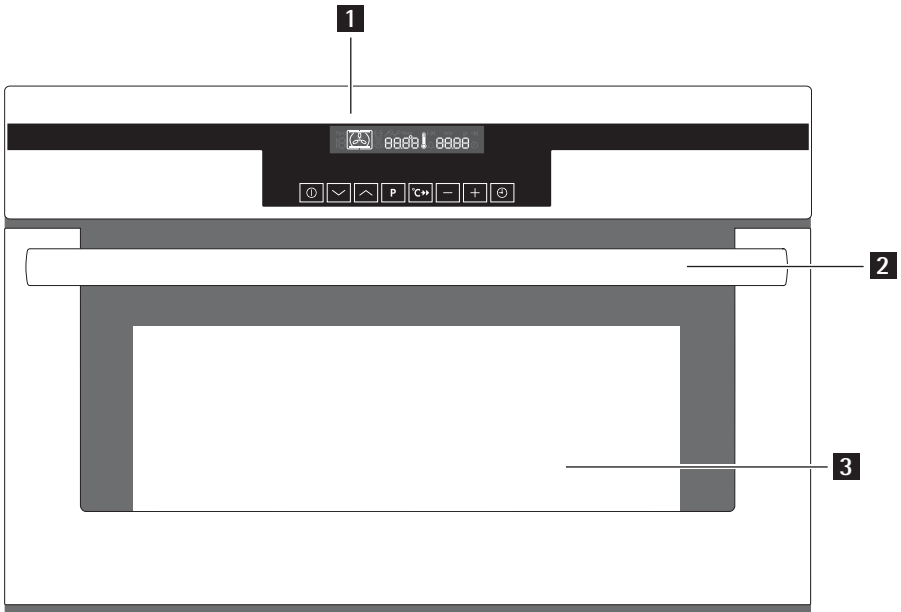

- 1** Control panel
- 2** Door handle
- 3** Full glass door



## Control panel

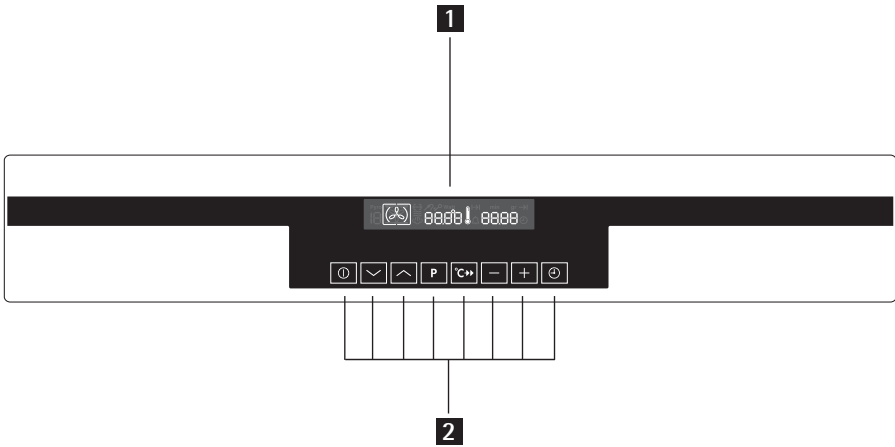

- 1** Oven displays
- 2** Oven functions buttons

## Oven layout

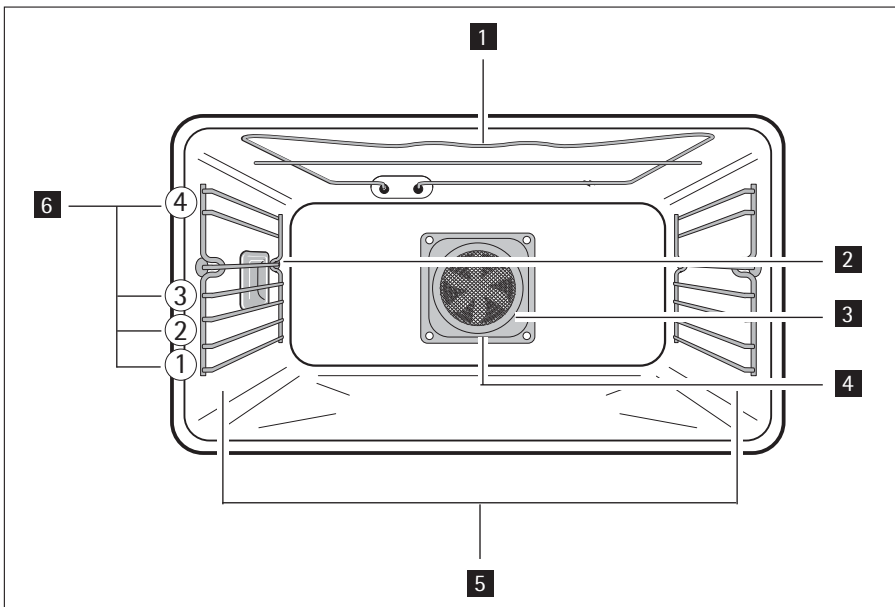

- 1** Grill heating element

- 2 Oven lighting
- 3 Grease filter
- 4 Rear wall heating element fan
- 5 Side rails, removable
- 6 Oven shelf levels

## Accessories Oven

### Oven shelf

For cookware, cake tins, roasts and grilling food.

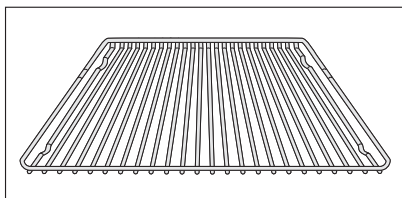

### Baking tray

For cakes and biscuits.

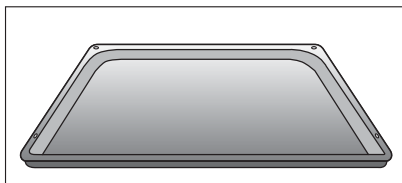

## Before using for the first time

### Setting and changing the time

**i** The oven only operates when the time has been set.

When the appliance has been connected to the electrical supply or when there has been a power cut, the symbol for the time ⌚ automatically flashes.

- To change a time that has already been set, press the clock functions button ⌚ repeatedly until the symbol for the time ⌚ flashes.

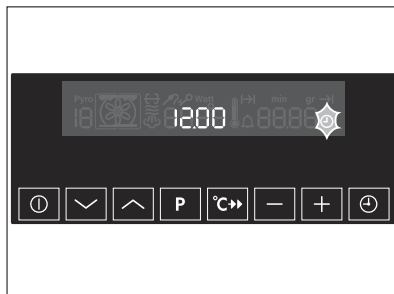

- Using the  $\oplus$  or  $\ominus$  button, set the current time.

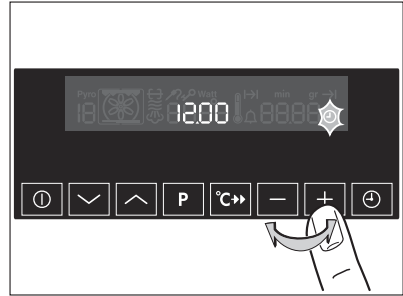

After approx. 5 seconds, the flashing stops and the clock displays the time set.  
The appliance is now ready to use.

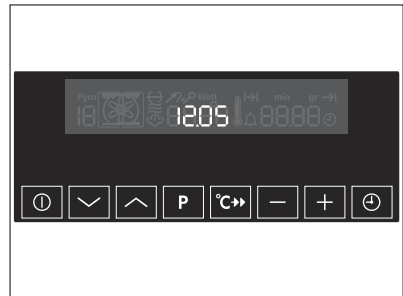

- i** The time can only be modified, if the child safety device is deactivated, none of the clock functions Countdown  $\text{⏰}$ , Cook Time  $\text{⏱}$  or End Time  $\text{⏲}$  and none of the oven functions are set.

## Cleaning for the first time

Before you use the appliance for the first time, you should clean it thoroughly.



Do not use any sharp or abrasive cleaning tools or materials. These could damage the surface.





For metal fronts, use normal commercially available cleaning agents.

- Open the oven door.  
The lighting in the oven is switched on.
- Remove all accessories and side rails and clean with a warm solution of water and washing-up liquid.
- Also wipe the oven out with a warm solution of water and washing-up liquid and then dry it.
- Wipe the front of the appliance with a damp cloth.

## Getting to know the appliance



The appliance can be operated in test mode to test or demonstrate all operating steps. The oven does not heat up.

### Test mode Switching on

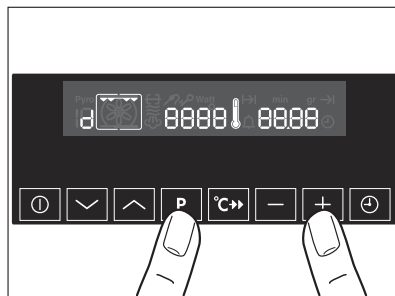
1. Switch the appliance off using the On/Off button  .
2. Press and hold the Baking/Roasting Programmes buttons  and  at the same time until a signal sounds and "d" lights up in the display.



### Switching test mode off

1. Switch the appliance off using the On/Off button  .
2. Press and hold the Baking/Roasting Programmes buttons  and  at the same time until a signal sounds and "d" goes out in the display.

## Operating the oven

### The electronic oven controls

#### The display field

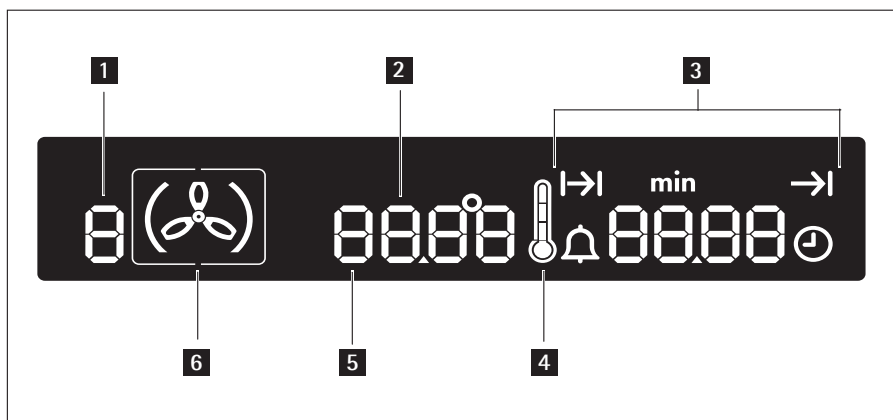

**1** Memory: P / Test: d

- 2 Temperature/Time
- 3 Clock functions/Operating time
- 4 Thermometer symbol
- 5 Baking/Roasting Programmes
- 6 Oven functions

## The control panel

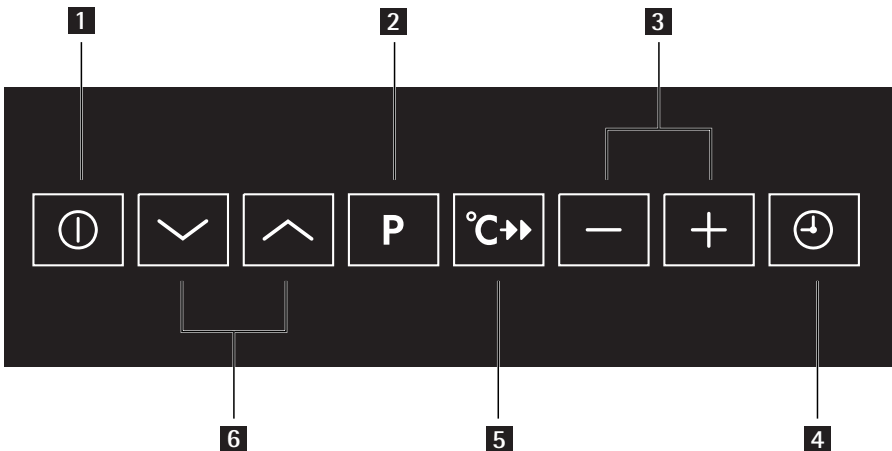

- 1 On/Off
- 2 Baking/Roasting Programmes
- 3 button +/-
- 4 Clock functions
- 5 Fast heating
- 6 Oven function selection

### General instructions



- Always switch appliance on first by pressing the On/Off button .
- When the selected function is lit, the oven begins to heat up or the time set begins to count down.
- When the selected temperature is reached, a signal sounds.

- The oven light is switched on as soon as an oven function is started or the oven door is opened.

The oven light goes off after 10 minutes when the door is open and the appliance switched off.

- Switch the appliance off using the On/Off button .

## Selecting the oven function

1. Switch the appliance on using the On/Off button .
2. Press the  or  button repeatedly until the desired oven function appears.

- A suggested temperature appears in the temperature display.
- If the suggested temperature is not changed within approx. 5 seconds, the oven begins to heat up.

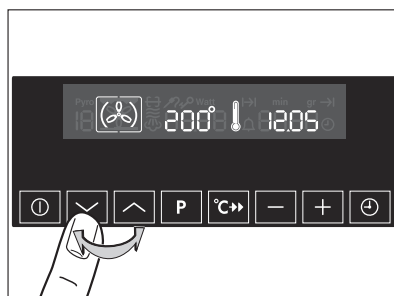



## Changing the oven temperature

Press the  or  button to raise or lower the temperature.

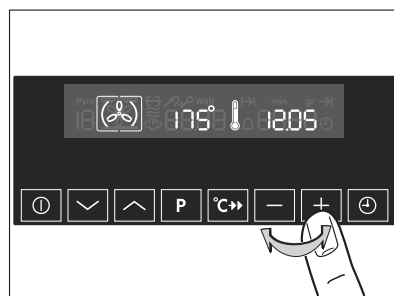

The setting changes in 5 °C steps.



## Thermometer symbol

- The slowly rising thermometer symbol  indicates how far the oven has heated up.
- The three segments of the thermometer symbol  flashing one after the other show that Fast Warm Up is on.

## Changing the oven function

To change the oven function, press the  or  button repeatedly until the desired oven function is displayed.

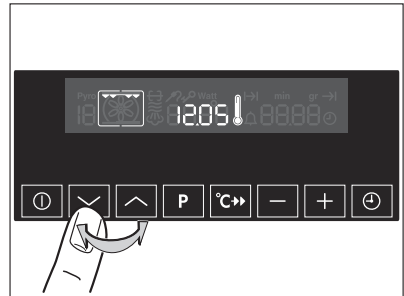

## Switching the oven off

Switch the appliance off using the On/Off button .



### Cooling fan

The fan switches on automatically to keep the appliance surfaces cool. When the oven is switched off, the fan continues to run to cool the appliance down and then switches itself off.

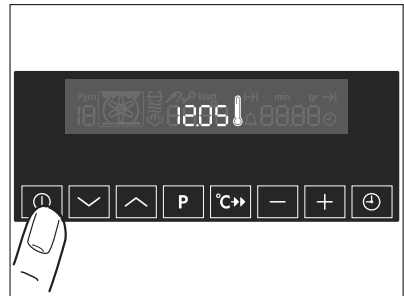



## Fast Warm Up

After an oven function has been selected, the empty oven can be pre-heated in a relatively short time using the additional function Fast Warm Up.



### CAUTION!





Please do not put the food to be cooked into the oven, until Fast Warm Up is completed and the oven is operating using the desired function.

1. Set desired oven function. If necessary, change the suggested temperature.
2. Press the Fast Warm Up button . The symbol  lights up. When the bars flash one after the other it shows that Fast Warm Up is operating.

When the temperature set is reached, the bars of the heat indicator are lit. A signal sounds. The symbol  goes out.

The oven now continues heating according to the pre-set oven function and temperature. You can now place the food in the oven.

## Oven Functions

Oven function	Application
 <b>Ventitherm® Fan Operated Cooking</b>	For roasting and <b>baking</b> on <b>up to two oven levels</b> at the same time.
 <b>Rotitherm Roasting</b>	For <b>roasting</b> larger pieces of meat or poultry on one oven level. The function is also suitable for <b>gratinating</b> and <b>browning</b> the top of dishes.
 <b>Single Economy Grill</b>	For <b>grilling</b> flat foodstuffs and for <b>toasting</b> .
 <b>Defrost/Drying</b>	For <b>defrosting</b> and <b>drying</b> herbs, fruit or vegetables.
 <b>Low Temperature Cooking</b>	For preparing particularly tender, succulent roasts.

## Inserting the oven shelf and baking tray

 Shelf runner safety and anti-tip device

To increase shelf runner safety, all insertable components have a small curved indentation at the bottom on the right and left-hand edge.

Always insert insertable components so that this indentation is at the back of the oven interior. This indentation is also important for preventing the insertable components from tipping.

### Baking tray Inserting the :

Push the baking tray between the guide bars of the selected oven level.

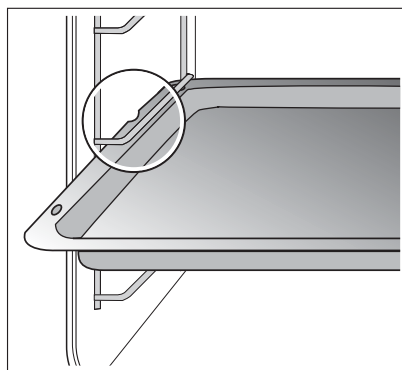



### Oven shelf

Insert the oven shelf so that the feet point downwards.

Push the oven shelf between the guide bars of the selected oven level.



The high rim around the oven shelf is an additional device to prevent cookware from slipping off.

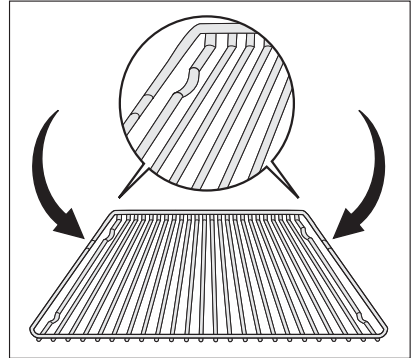

### Grease filter Inserting/Removing the

**Only use the grease filter when roasting** to protect the rear heating elements from fat splashes.

#### Inserting the grease filter

Hold the grease filter by the tab and insert the two mounts downwards into the opening on the rear wall of the oven (fan opening).

#### Removing the grease filter

Hold the grease filter by the tab, unhook it and lift out.

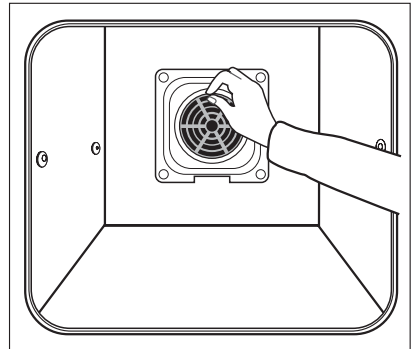









### Additional functions

#### Baking and Roasting Programmes



Use the pre-set recipes for this function.

#### Selecting a programme

- Switch the oven on using the On/Off button . Press the Baking/Roasting Programmes button , then press the  or  button repeatedly, until the desired programme appears in the display (P1 to P12).
  - The symbol for the corresponding oven function appears in the function display.
  - The cooking time appears in the clock display, the symbol for Cook Time  lights up.
  - Press the clock functions button , then press the  or  button to change the cook time.
  - After approx. 5 seconds, the oven switches itself on.
- When the time has elapsed, a signal sounds for 2 minutes. The symbol for Cook Time  flashes.  
The oven switches itself off.
- The signal can be stopped by pressing any button.

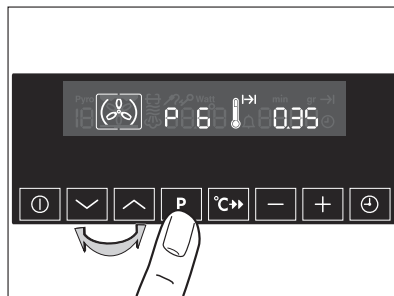

### Delaying the start



The start of the cooking time can be delayed (see Clock Functions End Time ).

### Ending cooking time early

Switch the oven off using the On/Off button .

## Memory function

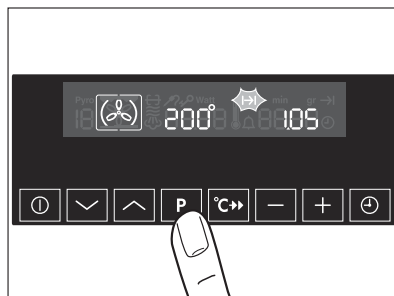

The Memory function can be used to save **one** setting which is used very frequently.

- Set oven function, temperature and, if necessary, the clock functions Cook Time  and/or End Time .
- Press and hold the Baking/Roasting Programmes button  for approx. 2 seconds until a signal sounds. The setting is saved.



To save another setting, press the Baking/Roasting Programmes button  for approx. 2 seconds. The previously saved setting is replaced by the new one.

### Starting the Memory function

1. Switch the oven on using the On/Off button .
2. Use the Baking/Roasting Programmes button  to call up the saved setting.

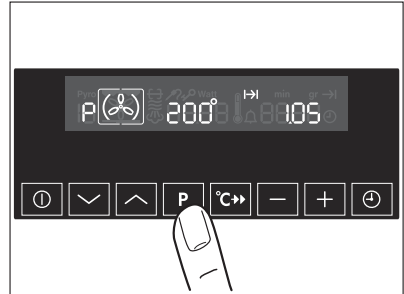

### Clock functions

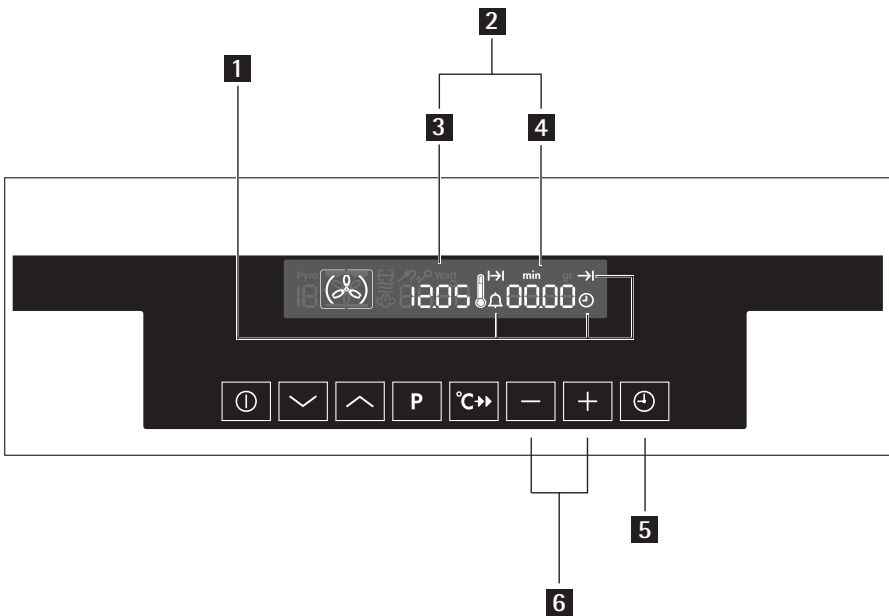

- 1 Clock functions
- 2 Clock displays
- 3 Time
- 4 Cook Time/End Time/Operating Time
- 5 Clock functions
- 6 Selector buttons

### Countdown

To set a countdown. When it has counted down, a signal sounds.

This function has no effect on the operation of the oven.

### Cook Time $\rightarrow$

To set how long the oven is to operate.

### End Time $\rightarrow$

For setting when the oven is to switch itself off again.

### Time $\oplus$

To set, change or find out the time (see section Before using for the first time)



### General instructions

- After a clock function has been selected, the corresponding symbol flashes for about 5 seconds. During this period, the desired times can be set or modified using the  $\oplus$  or  $\ominus$  button.
- When the desired time has been set, the symbol continues to flash for approx. 5 seconds. After this the symbol lights up. The set Countdown  $\triangle$  begins to count down.
- The time set for Cook Time  $\rightarrow$  and End Time  $\rightarrow$  begins to count down after the selected function starts.

## Countdown $\triangle$

1. Press the clock functions button  $\oplus$  repeatedly until the symbol for Countdown  $\triangle$  flashes.

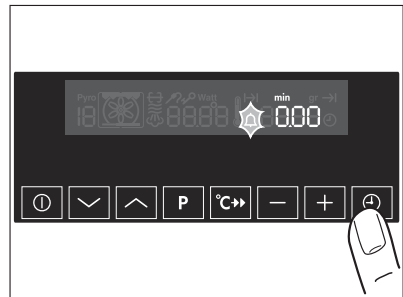

- Using the  $\oplus$  or  $\ominus$  button, set the desired Countdown (max. 99.00 minutes).

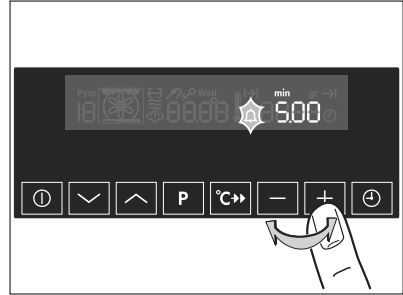

After approx. 5 seconds the display shows the time remaining. The symbol for Countdown  $\triangle$  lights up.

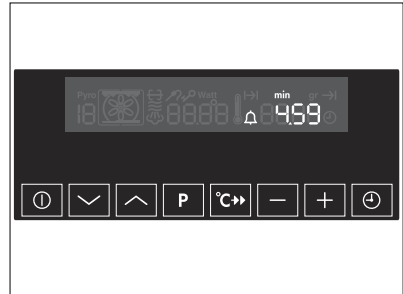

When the time has elapsed, a signal sounds for 2 minutes. "0.00" lights up and the symbol for Countdown  $\triangle$  flashes.

To turn off the signal: Press any button.



## Cook Time $\rightarrow$

- Select oven function and using the  $\oplus$  or  $\ominus$  button select the temperature.
- Press the clock functions button  $\opl�$  repeatedly until the symbol for Cook Time  $\rightarrow$  flashes.

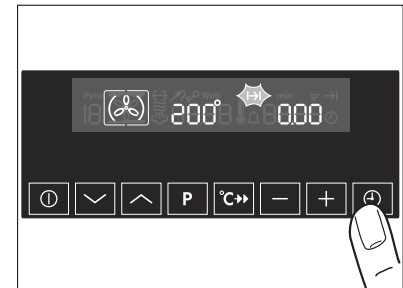

3. Using the  $\boxed{+}$  or  $\boxed{-}$  button set the desired cooking time.

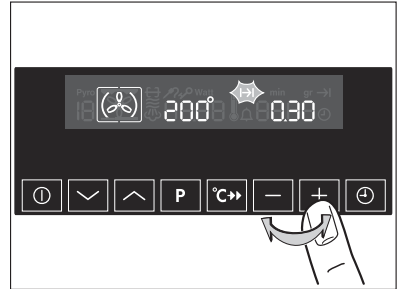

The oven switches itself on. The symbol for Cook Time  $\rightarrow$  lights up.

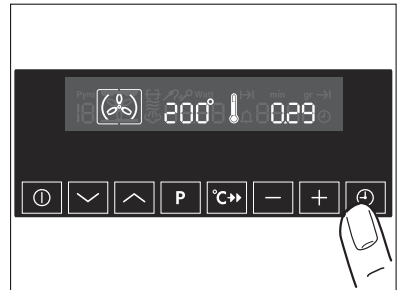

By repeatedly pressing the clock functions button  $\boxed{\text{⌚}}$  the current time will be shown.

When the time has elapsed, a signal sounds for 2 minutes. The oven switches itself off. "0.00" is displayed and the symbol for Cook Time  $\rightarrow$  flashes.

To turn off the signal: Press any button.

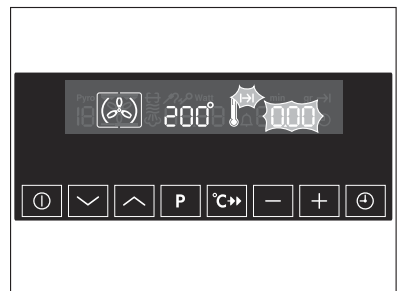

## End Time $\rightarrow$

1. Select oven function and using the  $\boxed{+}$  or  $\boxed{-}$  button select the temperature.
2. Press the clock functions button  $\boxed{\text{⌚}}$  repeatedly until the symbol for End Time  $\rightarrow$  flashes.

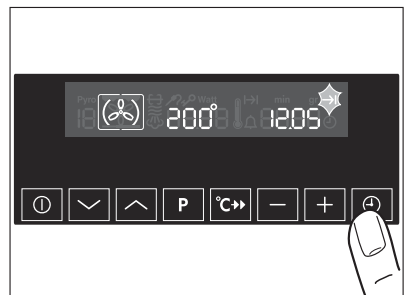

3. Using the  $\oplus$  or  $\ominus$  button, set the desired switch-off time.

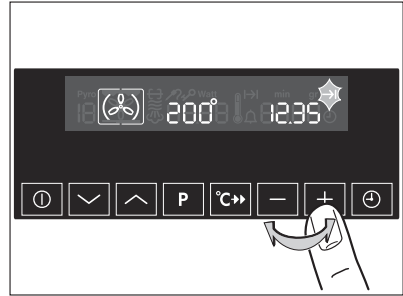

The symbols for End Time  $\rightarrow$  and Cook Time  $\rightarrow$  light up.

The oven switches itself on automatically.



By repeatedly pressing the clock functions button  $\oplus$ , the current time can be found out.



When the time has elapsed, a signal sounds for 2 minutes. The oven switches itself off.

"0.00" is displayed and the symbols for End Time  $\rightarrow$  and Cook Time  $\rightarrow$  flash.

To turn off the signal: Press any button.



## Cook Time $\rightarrow$ and End Time $\rightarrow$ combined



Cook Time  $\rightarrow$  and End Time  $\rightarrow$  can be used simultaneously, if the oven is to be switched on and off automatically **at a later time**.

1. Select oven function and temperature.
2. Using the Cook Time function  $\text{I} \rightarrow \text{I}$ , set the time required for cooking the dish,  
e. g. 1 hour.
3. Using the End Time function  $\rightarrow \text{I}$ , set the time at which the dish is to be ready,  
e. g. at 14:05.

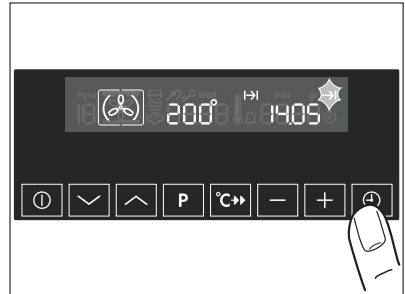
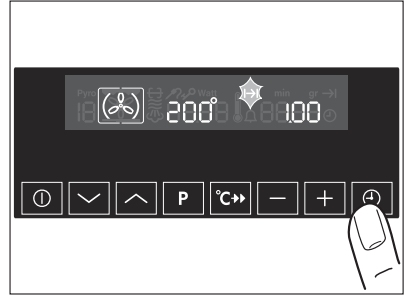

The symbols for Cook Time  $\text{I} \rightarrow \text{I}$  and End Time  $\rightarrow \text{I}$  light up.

The oven switches itself on automatically at the time calculated, e. g. at 13:05.

When the set cook time has elapsed, a signal sounds for 2 minutes and the oven switches itself off, e. g. at 14:05.

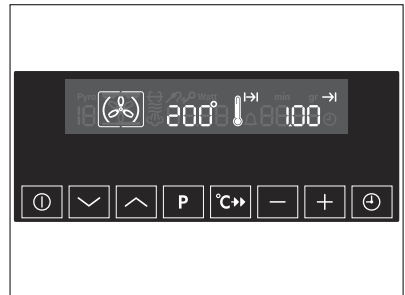

## Other functions

### Switching off the display





You can save energy by switching off the display.

### Switching off the display

1. If necessary, switch off the appliance using the On/Off button  $\text{I} \text{O}$ . Residual heat must not be displayed.



2. Press the clock functions buttons  and  at the same time until the display goes out.



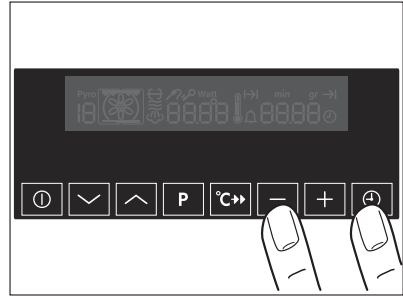

As soon as the appliance is operated again, the display automatically switches itself on. When the appliance is next switched off, the display goes out again.

To have the time permanently displayed again, you must switch the display on again.





### Switching on the display

1. If necessary, switch off the appliance using the On/Off button .
2. Press the clock functions buttons  and  at the same time until the display appears again.

### Child safety device

As soon as the child safety device is activated, it is no longer possible to operate the oven.



#### Switching on the child safety device

1. If necessary, switch off the appliance using the On/Off button . An oven function must not be selected.
2. Press and hold the Baking/Roasting Programme buttons  and  at the same time, until SAFE appears in the display.

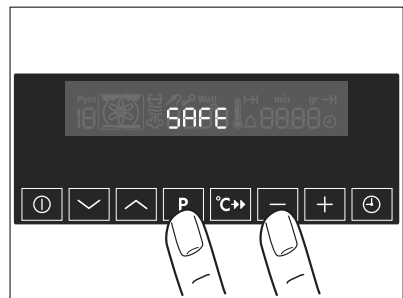
The child safety device is now activated.





#### Switching off the child safety device

1. If necessary, switch off the appliance using the On/Off button .
2. Press and hold the Baking/Roasting Programme buttons  and  at the same time, until SAFE goes out in the display.

The child safety device is now deactivated and the appliance is again ready for use.



## Button Beep

### Switching off button beep

1. If necessary, switch off the appliance using the On/Off button .
2. Press and hold the  and  buttons at the same time, until a signal sounds (approx. 2 seconds).

The button beep is now switched off.

### Switching on button beep

Press and hold the  and  buttons at the same time, until a signal sounds (approx. 2 seconds).

The button beep is switched on again.

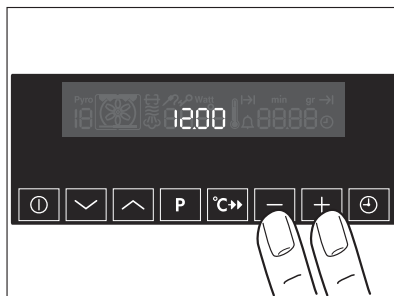

## The oven's automatic switch-off



If the oven not switched off after a certain time, or if the temperature is not modified, it switches off automatically.

The last temperature set flashes in the temperature display.

### The oven switches itself off at an oven temperature of:

30 - 120° C after 12.5 hours

120 - 200° C after 8.5 hours

200 - 250° C after 5.5 hours

OFF appears in the display.

### Starting up after an automatic switch-off

Switch the oven off completely. It can then be operated again.

## Usage, Tables and Tips

### Baking

Oven function: Ventitherm® Fan Operated Cooking 

#### Baking tins

- For Ventitherm® Fan Operated Cooking  light metal tins are suitable.

## Oven levels

- With Ventitherm® Fan Operated Cooking (A), you can bake on up to 2 baking trays at the same time:

1 baking tray:

e. g. oven level 2

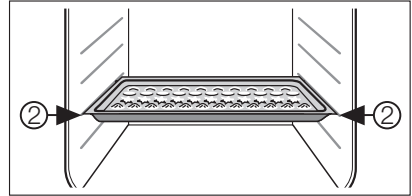

1 cake tin:

e. g. oven level 1

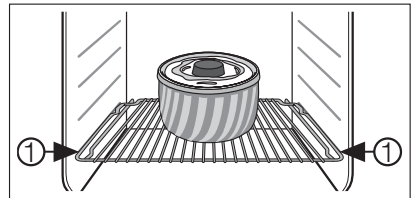

2 baking trays:

e. g. oven levels 2 and 4

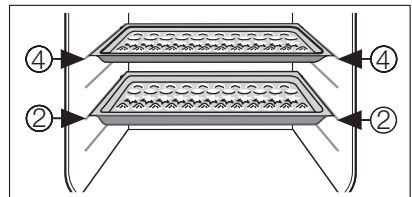

## General instructions

With Ventitherm® Fan Operated Cooking (A) you can also bake with two cake tins next to each other on the oven shelf at the same time. This does not significantly increase the baking time.



If using frozen food, the inserted trays can warp during the cooking process. This is due to the large temperature difference between the frozen food and the oven temperature. After the trays have cooled, the deformation disappears.

## How to use the Baking Tables

The tables give the required temperature settings, cooking times and oven levels for a selection of typical dishes.

- Temperatures and baking times are for guidance only, as these will depend on the consistency of pastry, dough or mixture, the amount and the type of baking tin.

- We recommend using the lower temperature the first time and then, if necessary, e. g. if a more intense browning is required or baking time is too long, select a higher temperature.
- If you cannot find the settings for a particular recipe of your own, look for the one that is most similar.
- If baking cakes on baking trays or in tins on more than one level, baking time can be extended by 10-15 minutes.
- Moist bakery items (e. g. pizzas, fruit flans, etc.) are baked on one level.
- Cakes and pastries at different heights may brown at an uneven rate at first. If this occurs, **please do not change the temperature setting**. Different rates of browning even out as baking progresses.
- Your new oven may bake or roast differently to your previous appliance. If this is the case, adjust your normal settings (temperature, cooking times) and oven levels to the recommendations in the following tables.



With longer baking times, you can switch the oven off about 10 minutes before the end of baking time to make use of the residual heat.

Unless otherwise stated, the values given in the tables assume that cooking is started with the oven cold.

## Baking Table

Baking on one oven level			
Type of baking	Ventitherm® Fan Operated Cooking (A)		
	Oven level	Temperature °C	Time Hrs.: Mins.
<b>Baking in tins</b>			
Ring cake or brioche	1	160-170	0:50-1:10
Madeira cake/Fruit cakes	1	150-170	1:10-1:30
Sponge cake	1	160-180	0:25-0:40
Flan base - shortcrust pastry	2	170-190	0:10-0:25
Flan base - sponge mixture	2	150-170	0:20-0:25
Apple tart (covered)	1	160-180	0:50-1:00
Apple pie (2 tins Ø 20cm, diagonally off set)	1	180-190	1:05-1:20
Savoury flan (e. g. quiche lorraine)	2	170-190	0:30-1:10
Cheesecake	1	160-180	1:00-1:30
<b>Cakes/pastries/breads on baking trays</b>			

Baking on one oven level			
Type of baking	Ventitherm® Fan Operated Cooking 		
	Oven level	Temperature °C	Time Hrs.: Mins.
Plaited bread/bread crown	1	160-180	0:30-0:40
Christmas stollen	1	160-180	0:40-1:00
Bread (rye bread)	1	180-200	0:45-0:60
Cream puffs/éclairs	2	170-190	0:30-0:40
Swiss roll	2	200-220 <sup>1)</sup>	0:08-0:15
Cake with crumble topping(dry)	2	160-180	0:20-0:40
Buttered almond cake/sugar cakes,	2	170-190 <sup>1)</sup>	0:15-0:30
Fruit flan (made with yeast dough/sponge mixture)	2	160-180	0:25-0:50
Fruit flan made with shortcrust pastry	2	170-190	0:40-1:20
Yeast cakes with delicate toppings (e. g. quark, cream, custard)	2	150-170	0:40-1:20
Pizza (with a lot of topping)	2	190-210 <sup>1)</sup>	0:20-0:40
Pizza (thin crust)	2	230 <sup>1)</sup>	0:12-0:20
Unleavened bread	2	230 <sup>1)</sup>	0:10-0:20
Swiss flaky pastry tarts	2	190-210	0:35-0:50
<b>Biscuits</b>			
Short pastry biscuits	2	160-180	0:06-0:20
Viennese whirls	2	160	0:10-0:40
Biscuits made with sponge mixture	2	160-180	0:15-0:20
Pastries made with egg white, meringues	2	80-100	2:00-2:30
Macaroons	2	100-120	0:30-0:60
Biscuits made with yeast dough	2	160-180	0:20-0:40
Puff pastries	2	180-200 <sup>1)</sup>	0:20-0:30
Bread rolls	2	210-230	0:20-0:35
Small cakes (20 per tray)	2	170 <sup>1)</sup>	0:20-0:30

1) Pre-heat oven

Baking on more than one oven level			
Type of baking	Ventitherm <sup>®</sup> Fan Operated Cooking 	Temperature in °C	Time Hrs.: Mins.
	Oven level from the bottom		
	2 levels		
Biscuits			
Short pastry biscuits	2 / 4	160-180	0:15-0:35
Viennese whirls	2 / 4	160	0:20-0:60
Biscuits made with sponge mixture	2 / 4	160-180	0:25-0:40
Pastries made with egg white, meringues	2 / 4	80-100	2:10-2:50
Macaroons	2 / 4	100-120	0:40-1:20
Danish pastries	2 / 4	160-180	0:30-0:60
Puff pastries	2 / 4	180-200 <sup>1)</sup>	0:30-0:50

1) Pre-heat oven

## Tips on baking

Baking results	Possible cause	Remedy
The cake is not browned enough at the bottom	Wrong oven level used	Place cake lower in the oven
The cake sinks (becomes soggy, lumpy, streaky)	Oven temperature too high	Use a slightly lower temperature setting
	Baking time too short	Increase baking time <b>Baking times cannot be reduced by setting a higher oven temperature</b>
	Too much liquid in the mixture	Use less liquid. Pay attention to mixing times, especially if using mixing machines
Cake is too dry	Oven temperature too low	Use a higher oven temperature setting
	Baking time too long	Reduce baking time
Cake browns unevenly	Oven temperature too high and baking time too short	Use a lower oven temperature setting and increase baking time



Baking results	Possible cause	Remedy
	Cake mixture/dough is unevenly distributed	Spread the mixture/dough evenly on the baking tray
	Grease filter is inserted	Removing the grease filter
Cake is not done within the baking time given	Temperature too low	Use a slightly higher oven temperature setting
	Grease filter is inserted	Remove the grease filter

## Bakes and Gratins Table

Dish	Ventitherm® Fan Operated Cooking 		
	Oven level	Temperature °C	Time Hrs.: Mins.
Pasta bake	1	180-200	0:45-1:00
Lasagne	1	180-200	0:25-0:40
Gratinated vegetables <sup>1)</sup>	1	160-170	0:15-0:30
Gratinated baguettes <sup>1)</sup>	1	160-170	0:15-0:30
Sweet bakes	1	180-200	0:40-0:60
Fish bakes	1	180-200	0:30-1:00
Stuffed vegetables	1	160-170	0:30-1:00

1) Pre-heat oven

## Frozen Ready Meals Table

Food to be cooked	Oven function		Oven level	Temperature °C	Time
Frozen pizza		Ventitherm® Fan Operated Cooking	3	as per manufacturer's instructions	as per manufacturer's instructions
Chips <sup>1)</sup> (300-600 g)		Rotitherm Roasting	3	200-220	as per manufacturer's instructions
Baguettes		Ventitherm® Fan Operated Cooking	3	as per manufacturer's instructions	as per manufacturer's instructions

Food to be cooked	Oven function		Oven level	Temperature °C	Time
Fruit flan		Ventitherm® Fan Operated Cooking	3	as per manufacturer's instructions	as per manufacturer's instructions

1) Turn chips 2 or 3 times during cooking

## Roasting

### Oven function Ventitherm® Fan Operated Cooking

Insert the grease filter when roasting.

#### Ovenware for roasting

- Any heat-resistant ovenware is suitable to use for roasting. (Please follow the manufacturer's instructions.)
- We recommend roasting all lean meats **in a roasting tin or dish with a lid**. The meat will be more succulent.
- All types of meat that can be browned or have crackling, can be roasted in a **roasting tin or dish without a lid**.



Tips on using the Roasting Table

The information given in the following table is for guidance only.

- We recommend meat and fish **weighing 1 kg or more** for roasting in the oven.
- To prevent escaping meat juices or fat from burning on to the pan, we recommend placing some liquid in the roasting cookware.
- Turn the meat as required (after 1/2 - 2/3 of the cooking time).
- Use the cooking juices to baste large roasts and poultry several times during the cooking time. This will give better roasting results.
- Switch the oven off approx. 10 minutes before the end of roasting time to make use of the residual heat.

## Roasting Table

Food to be roasted	Ventitherm® Fan Operated Cooking 		
	Oven level	Temperature °C	Hrs.: Mins.
Pork			



Food to be roasted	Ventitherm® Fan Operated Cooking 		
	Oven level	Temperature °C	Hrs.: Mins.
Shoulder, neck, ham joint (1,000-1,500g)	1	170-190	1:30-2:00
Chops, Kasseler (smoked loin of pork) (1,000-1,500g)	1	180-200	1:00-1:30
Meat loaf (750-1,000 g)	1	180-200	0:45-1:00
Knuckle of pork (pre-cooked) (750-1,000g)	1	170-190	1:30-2:00
<b>Beef</b>			
Pot roast (1,000-1,500 g)	1	180-200	2:00-2:30
Roast beef or filet, per cm of thickness	1	210-230 <sup>1)</sup>	0:06-0:09 per cm of thickness
<b>Veal</b>			
Pot roast (1,000-1,500 g)	1	170-190	1:30-2:00
Knuckle of veal (1500-2000 g)	1	170-190	2:00-2:30
<b>Lamb</b>			
Leg of lamb (1,000-1,500 g)	1	170-190	1:15-2:00
Saddle of lamb (1,000-1,500 g)	1	180-200	1:00-1:30
<b>Quick roast items cooked on a baking tray</b>			
Sausages 'cordon bleu'	1	220-230 <sup>1)</sup>	0:05-0:08
Small sausages	1	220-230 <sup>1)</sup>	0:12-0:15
Schnitzel or chops, crumbed	1	220-230 <sup>1)</sup>	0:15-0:20
Rissoles	1	210-220 <sup>1)</sup>	0:15-0:20
<b>Fish (steamed)</b>			
Whole fish (1,000-1,500g)	1	210-220	0:45-1:15
<b>Poultry</b>			
Chicken, poulard (1-1.5 kg)	1	190-210	0:45-1:15
Half chicken (per 400-500 g)	1	200-220	0:35-0:50
Poultry pieces (per 200-250 g)	1	200-220	0:35-0:50
Duck (1500-2000 g)	1	180-200	1:15-1:45
<b>Game</b>			
Saddle of hare, leg of hare (up to 1,000 g)	1	220-230 <sup>1)</sup>	0:25-0:40

Food to be roasted	Ventitherm® Fan Operated Cooking 		
	Oven level	Temperature °C	Hrs.: Mins.
Saddle of venison (1,500-2,000 g)	1	210-220	1:15-1:45
Leg of venison (1,500-2,000 g)	1	200-210	1:30-2:15

1) Pre-heat oven

## Low temperature cooking

### Oven function: Low temperature cooking

With the oven function Low Temperature Cooking, the joint becomes beautifully tender and remains particularly succulent.



We recommend Low Temperature Cooking for pieces of tender, lean meat and fish. Low Temperature Cooking is not suitable for e. g. pot roasts or fatty pork roasts. The oven heats up to the pre-set temperature. When this temperature is reached, a signal sounds. After that, the oven automatically switches to a lower temperature to continue cooking.



Important: Insert the grease filter when roasting.



When using the oven function Low Temperature Cooking   always cook dishes **without a cover**.

1. Sear the meat in a pan over a very high heat.
2. Place meat in a roasting dish or directly on the oven shelf with a tray underneath to catch the fat.
3. Place in the oven. Select oven function Low Temperature Cooking   , if necessary, change the temperature and cook until done. (See table.)

## Low Temperature Cooking Table

Food to be cooked <sup>1)</sup>	Weight g	Temperature setting	Oven level	Total time (mins.)
Roast beef	1000-1500	120	1	90-110
Fillet of beef	1000-1500	120	3	90-110
Roast veal	1000-1500	120	1	100-120

Food to be cooked <sup>1)</sup>	Weight g	Temperature setting	Oven level	Total time (mins.)
Steaks	200 - 300	120	3	20-30

1) Brown in a frying pan before cooking

## Single economy grill

**Oven function: Single economy grill**  with maximum temperature setting



Always grill with the oven door closed.

- For grilling, use both the oven shelf and the tray together.
- The grilling times are guidelines.
- Grilling is particularly suitable for flat pieces of meat or fish.

## Grilling Table

Food to be grilled	Oven level	Grilling time	
		1st side	2nd side
Rissoles	3	8-10 mins.	6-8 mins.
Pork fillet	2	10-12 mins.	6-10 mins.
Sausages	3	8-10 mins.	6-8 mins.
Fillet steaks, veal steaks	3	6-7 mins.	5-6 mins.
Fillet of beef, roast beef (approx. 1 kg)	2	10-12 mins.	10-12 mins.
Toast <sup>1)</sup>	3	4-6 mins.	3-5 mins.
Toast with topping	2	8-10 mins.	---

1) Use the oven shelf without a tray

## Rotitherm Roasting

### Oven function: Rotitherm Roasting

Dish	Temperature in ° C	Tray	Oven shelf	Grilling time in minutes	Turn after ... minutes
		Oven level			
Chicken (900-1,000 g)	160	1	2	50-60	25-30
Stuffed rolled pork roast (2,000 g)	160	1	2	90-95	45
Pasta bake	180	---	2	30	---
Gratinated potato bake	200	---	2	20-23	---
Gnocchi, gratinated	180	---	2	20-23	---
Cauliflower with Hollandaise Sauce	200	---	2	15	---

## Defrosting

### Oven function: Defrost/Drying (Temperature setting 30°C)

- Unwrap the food and place it on a plate on the oven shelf.
- Do not cover with a plate or bowl, as these can substantially lengthen the defrosting time.
- For defrosting, place the oven shelf in the **1st oven level from the bottom**.

### Defrosting Table

Dish	Defrosting time (mins.)	Further defrosting time (mins.)	Comment
Chicken, 1,000 g	100-140	20-30	Place chicken on an upturned saucer in a large plate. Turn halfway through.
Meat, 1,000 g	100-140	20-30	Turn halfway through
Meat, 500 g	90-120	20-30	Turn halfway through
Trout, 150 g	25-35	10-15	---
Strawberries, 300 g	30-40	10-20	---
Butter, 250 g	30-40	10-15	---

Dish	Defrosting time (mins.)	Further defrosting time (mins.)	Comment
Cream, 2 x 200g	80-100	10-15	Cream can also be whipped when still slightly frozen in places
Gateau, 1400g	60	60	---

## Drying

### Oven function: Defrost/Drying

- Use trays covered with greaseproof paper or baking parchment.
- You will get a better result, if you switch the oven off halfway through the drying time, open the door and leave it to cool down, preferably overnight.  
Then finish drying the food to be dried.

Food to be dried	Temperature in °C	Oven level		Time in hours (guideline)
		1 level	2 levels	
<b>Vegetables</b>				
Beans	75	2	2 / 4	6-9
Peppers (slices)	75	2	2 / 4	5-8
Vegetables for soup	75	2	2 / 4	5-6
Mushrooms	50	2	2 / 4	6-9
Herbs	40-50	2	2 / 4	2-4
<b>Fruit</b>				
Plums	75	2	2 / 4	8-12
Apricots	75	2	2 / 4	8-12
Apple slices	75	2	2 / 4	6-9
Pears	75	2	2 / 4	9-13

## Making preserves

### Oven function: Ventitherm® Fan Operated Cooking

- When making preserves, only use commercially available preserve jars of the same size.

- **Jars with twist-off or bayonet type lids and metal tins are not suitable.**
- When making preserves, use the **first shelf position from the bottom.**
- Use the baking tray for making preserves. There is enough room on this for up to six 1-litre preserving jars.
- The jars should all be filled to the same level and clamped shut.
- Place the jars on the baking tray in such a way that they are not touching each other.
- Pour approx. 1/2 litre of water into the baking tray, so that sufficient moisture is produced in the oven.
- As soon as the liquid in the first jars starts to simmer (after approx. 35-60 minutes with 1 litre jars), switch the oven off or reduce the temperature to 100°C. (See table.)

## Preserves table

Preserve <sup>1)</sup>	Temperature in °C	Cooking time until simmering in minutes	Continue to cook at 100 °C (in minutes)
<b>Soft fruit</b>			
Strawberries, blueberries, raspberries, ripe gooseberries	160-170	35-45	---
Unripe gooseberries	160-170	35-45	10-15
<b>Stone fruit</b>			
Pears, quinces, plums	160-170	35-45	10-15
<b>Vegetables</b>			
Carrots <sup>2)</sup>	160-170	50-60	5-10
Mushrooms <sup>2)</sup>	160-170	40-60	10-15
Cucumbers	160-170	50-60	---
Mixed pickles	160-170	50-60	15
Kohlrabi, peas, asparagus	160-170	50-60	15-20
Beans	160-170	50-60	---

1) The times and temperatures for making preserves are for guidance only.

2) Leave standing in oven after switching off

## Programmed recipes

The appliance has 12 programmed functions/recipes, which can be selected one after the other using the Baking/Roasting Programmes button.

P 1	LEMON SPONGE CAKE
P 2	QUARK MANDARIN SLICE
P 3	WHITE BREAD
P 4	ROLLS 40 G EACH
P 5	PIZZA
P 6	QUICHE LORRAINE
P 7	POTATO GRATIN
P 8	FISH FILLET
P 9	SADDLE OF VEAL
P 10	LASAGNE
P 11	ROAST PORK
P 12	CHICKEN 1000 G

### LEMON SPONGE CAKE 1000 G

#### For the mixture:

- 250 g butter
- 200 g sugar
- 1 packet vanilla sugar
- 1 pinch salt
- 4 eggs
- 150 g flour
- 150 g cornflour
- 1 level teaspoon baking powder
- Grated rind of 2 lemons

#### Glaze:

- 1/8 l lemon juice
- 100 g icing sugar

Square baking tin, 30 cm long

Margarine for greasing

Breadcrumbs for coating baking tin

Place butter, sugar, lemon rind, vanilla sugar and salt in a mixing bowl and cream together. Then add the eggs one at a time and cream together again.

Add the flour and cornflour mixed with the baking powder to the creamed mixture and fold in.

Put the mixture into the greased and bread-crumbed baking tin, smooth out and put in the oven.

After baking, mix lemon juice and icing sugar. Turn the cake out onto a piece of aluminium foil.

Fold up the aluminium foil against the sides of the cake so that the glaze cannot run out. Pierce the cake with a wooden skewer and brush on the glaze.

Then leave the cake for a while to soak up the glaze.

Setting	Oven level	Cook time
P 1 LEMON SPONGE CAKE	2	60 mins.

## QUARK MANDARIN SLICE

### Ingredients for the pastry:

- 200 g flour
- 1 tsp. baking powder
- 100 g sugar
- 75 g butter
- 2 eggs
- 1 pinch salt
- Margarine for greasing

### Method for the dough:

Mix butter and sugar together well. Add eggs and also mix well.

Add sieved flour and baking powder to the fat/sugar mixture and then knead briefly to produce a workable pastry.

Put the pastry in the fridge for approx. 1 hour. Then roll out with a rolling pin and place on a greased baking tray.

### Ingredients for the topping:

- 500 g quark



- 80 ml sunflower oil
- 100 g crème fraîche
- 125 ml milk
- 2 eggs
- 140 g sugar
- 1/2 packet custard powder
- 1 tin of mandarins (1000 g)
- 1 packet flan glaze

### Method for the topping:

Put the ingredients in a mixing bowl and mix together evenly. Then add to the rolled out shortcrust pastry base. Spread out the mandarins on the quark topping. After baking, when the flan has cooled down, spread with the flan glaze.

Setting	Oven level	Cook time
P 2QUARK MANDARIN SLICE	3	55 mins.

## WHITE BREAD 600–800 G

### Ingredients:

- 500 g flour
- 1/2 cube fresh yeast or 1 packet dried yeast
- 330 ml milk
- 10 g salt

### Method:

Place flour and salt in a large bowl. Dissolve the yeast in tepid milk and add to the flour. Knead all ingredients into a workable dough.

More milk may be required, depending on the texture of the flour.

Leave the dough to rise until it doubles in volume.

Shape two loaves out of the dough and place them on the greased baking tray or patisserie tray (special accessory). Leave the loaves to rise again by half their volume.

Before baking, dust them with a little flour and use a sharp knife to cut 3 diagonal lines, at least 1 cm deep.

Setting	Oven level	Cook time
---------	------------	-----------

P 3 WHITE BREAD

2

55 mins.

## ROLLS 40 G EACH (12-16)

### Ingredients:

- 500 g flour, type 405
- 20 g cube of fresh yeast or 1 packet of dried yeast
- 300 ml water
- 10 g salt

### Method:

Place flour and salt in a large bowl. Dissolve the yeast in the water and add to the flour. Knead all ingredients into a workable dough.

Leave the dough to rise until it doubles in volume.

Cut the dough into pieces, form into rolls and place on the greased baking tray or patisserie tray (special accessory). Leave rolls to rise again for approx. 25 minutes.

Before baking, cut a cross in the rolls. Sprinkle with poppy, caraway or sesame seeds, if desired.

Setting

Oven level

Cook time

P 4 ROLLS 40 G EACH

3

25 mins.

## PIZZA

For 1 baking tray or 2 round tins

### Ingredients for the pastry:

- 300 g flour, type 405
- 200 ml water
- 14 g yeast
- 2 tablespoons oil
- 3 g salt

### Method for the dough:

Crumble yeast into a bowl and dissolve in tepid water. Mix the salt into the flour and add it with the oil to the bowl. Knead the ingredients until a workable dough that does not stick to the bowl is produced.

Then cover the dough and leave to rise until it doubles in volume.

**Ingredients for the topping:**

- 1 tin peeled tomatoes (800 g net), chopped
- 100 g salami, cut into slices, then quartered,
- 350-400 g Feta or mozzarella, cut into 1 cm cubes
- Oregano or pizza herbs

As a variation on the topping, button mushrooms or ham can also be used.

**Preparation:**

Sieve off the tomato juice. (Can be used for sauce.)

Roll out the dough, place on a greased baking tray. Prick dough well all over with a fork.

Place the ingredients for the topping on the base in the order given.

Distribute the Feta or mozzarella evenly. Finally sprinkle on the oregano.

**Setting**

P 5 PIZZA

**Oven level**

3

**Cook time**

25 mins.

## QUICHE LORRAINE

**Ingredients for the pastry:**

- 250 g flour, type 405
- 125 g butter
- 60 ml water
- 1 tsp salt
- A little pepper and nutmeg

**Method for the pastry:**

Mix together flour, butter and salt, add the water and knead together briefly to form a pastry.

Leave the pastry to cool in the fridge for 1 hour.

**Ingredients for the topping:**

- 100 ml milk
- 150 ml sour cream
- 2 eggs
- 150 g Gruyère or Emmental cheese, grated
- 150 g lean ham, diced

- 150 g onions, diced
- Pepper, nutmeg

### Method for the topping:

Lightly sauté the bacon and onions.

Whisk the milk, cream, eggs and seasoning together well, then mix in the cheese.

### Preparation:

Roll out the pastry and lay it in a greased plain springform tin (dia. 28cm). Spread the bacon and onions evenly over the base and pour the liquid mixture over it.

Setting	Oven level	Cook time
P 6QUICHE LORRAINE	3	40 mins.

## POTATO GRATIN

- 1,000 g potatoes
- 1 teaspoon each of salt and pepper
- 1 clove of garlic, peeled
- 300 g Gruyère or Emmental cheese, grated
- 3 eggs
- 250 ml milk
- 4 tablespoons cream
- 1 tablespoon thyme
- 3 tablespoons butter

### Method:

Peel potatoes, slice thinly, dry and then season with salt and pepper.

Place half of the potato slices in a greased, oven-proof dish. Sprinkle some grated cheese over them. Layer the rest of the potato slices over this and sprinkle the rest of the cheese on the top.

Crush the clove of garlic and beat it together with the eggs, milk, cream and the thyme. Salt the mixture and pour over the potatoes.

Place knobs of butter on the gratin.

Setting	Oven level	Cook time
P 7POTATO GRATIN	2	55 mins.

## FISH FILLET

### Ingredients:

- 700 g pike-perch fillet or sea trout fillet, cubed
- 100 g Emmental cheese, grated
- 200 ml cream
- 50 g breadcrumbs
- Salt, pepper, lemon juice
- Parsley, chopped
- 40 g butter to grease the dish

### Method:

Sprinkle the fish fillet with lemon juice and leave it to marinate for a while. Then dab off surplus juice using kitchen paper.

Then season the fish fillet on both sides with salt and pepper. Then place in a greased oven-proof dish.

Mix the cream, grated cheese, breadcrumbs and the chopped parsley and spread over the fish.

Setting	Oven level	Cook time
P 8 FISH FILLET	2	25 mins.

## SADDLE OF VEAL

### Ingredients:

- 1,000 g saddle of veal
- 2 tablespoons oil
- Salt, pepper, paprika

### Method:

Wash the saddle of veal and dry it with kitchen paper.

Mix the seasoning with the oil and use the mixture to coat the meat evenly.

Then place the saddle of veal in a oven-proof dish or glass dish with perforated insert (special accessory) and place it in the oven.

Setting	Oven level	Cook time
P 9 SADDLE OF VEAL	2	80 mins.

## LASAGNE

### Meat sauce:

- 100 g streaky bacon
- 1 onion and 1 carrot
- 100 g celery
- 2 tbsp olive oil
- 400 g mince (a mixture of beef and pork)
- 1 small tin of tomatoes, chopped (approx. 400 g)
- Oregano, thyme, salt and pepper
- 3 tablespoons butter
- 250 g green lasagne
- 50 g Parmesan cheese, grated
- 150 g Emmental cheese, grated

### Béchamel sauce:

- 75 g butter
- 50 g flour
- 500 ml milk
- Salt, pepper and nutmeg

Using a sharp knife cut the bacon from the rind and gristle and cut into fine dice. Peel the onion and carrot, clean the celery, dice all vegetables finely. Heat the oil in a casserole, sauté the bacon and the diced vegetables in the oil while stirring constantly. Gradually add the mince, sauté while stirring constantly to break up and deglaze with the meat stock. Season the meat sauce with tomato purée, the herbs, salt and pepper and simmer with the lid on over a low heat for about 30 minutes.

In the meantime prepare the Béchamel sauce. To do this melt the butter in a pan, sprinkle in the flour and cook until golden, stirring constantly. Gradually pour in the milk, stirring constantly. Season the sauce with salt, pepper and nutmeg and simmer without a lid for about 10 minutes. Grease a large rectangular ovenproof dish with 1 tablespoon of butter.

Layer alternately a layer of pasta sheets, meat sauce, Béchamel sauce and mixed cheese in the dish. The last layer should be a layer of Béchamel sauce sprinkled with cheese. Place the rest of the butter in small knobs on the top of the dish.

**Setting**

**Oven level**

**Cook time**

**P 10 LASAGNE**

2

50 mins.

## ROAST PORK

### Ingredients:

- Roast pork from the neck
- 2 tablespoons oil
- Salt, pepper, paprika

### Method:

Wash the meat and dry it with kitchen paper.

Mix the seasoning with the oil and use the mixture to coat the meat evenly all over. Then place the pork in an ovenproof dish with a perforated insert (special accessory).

After approx. 40 minutes, turn the roast.

After the first acoustic signal, check how the meat is cooking. If necessary, increase the remaining roasting time until the 2nd acoustic signal (10 mins.).

**Setting****Oven level****Cook time****P 11 ROAST PORK**

2

90 mins.

## CHICKEN 1200 G

### Ingredients:

- 1 Chicken (1,000 - 1,200 g)
- 2 tablespoons oil
- Salt, pepper, paprika and curry powder

### Method:

Wash the chicken and dry it with kitchen paper.

Mix the spices with the oil and use the mixture to coat the chicken evenly inside and out.

Then place the chicken, breast-side down, in an ovenproof dish or glass dish with perforated insert (special accessory). After approx. 25 minutes, turn the chicken.

After the first acoustic signal (approx. 50 mins.), check how the meat is cooking. If necessary, leave it to cook for the remaining roasting time until the second acoustic signal (approx. 60 mins.).

**Setting**

P 12CHICKEN 1200 G

**Oven level**

2

**Cook time**

55 mins.

## Cleaning and care

**WARNING!**

When cleaning, the appliance must be switched off and cooled down.

**WARNING!**

For safety reasons, do not clean the appliance with steam jet or high-pressure cleaning equipment.

**CAUTION!**

Do not use any scouring agents, sharp cleaning tools or scourers.

**CAUTION!**

Do not use any rough, polishing cleaners or sharp metal scrapers to clean the glass that can scratch the surface, as this can cause the glass to break.

## The outside of the appliance

- Wipe down the front of the appliance with a soft cloth and a solution of hot water and washing-up liquid.
- For metal fronts, use normal commercially available cleaning agents.
- Please do not use any scouring agents or abrasive sponges.

## Oven interior

Clean the oven after every use. This is the easiest way to remove dirt which then cannot burn on.

1. When the oven door is opened, the oven light switches itself on automatically.
2. Wipe out the oven after every use with a solution of water and washing-up liquid and then dry it.



Remove stubborn dirt with special oven cleaners.



When using oven sprays, please follow the manufacturers' instructions exactly.



## Oven interior

Clean the oven after every use. This is the easiest way to remove dirt which then cannot burn on.

1. When the oven door is opened, the oven light switches itself on automatically.
2. Wipe out the oven after every use with a solution of washing-up liquid and then dry it.



Remove stubborn dirt with special oven cleaners.



When using oven sprays, please follow the manufacturer's instructions exactly.

## Oven roof with catalytic self-cleaning surface

### (rough, porous surface)

The oven roof has a catalytic self-cleaning surface, from which small food deposits are burnt off at temperatures over 200 °C.

Please observe the following instructions to ensure the best working of this self-cleaning surface.



### CAUTION!

Do not use cleaning agents, oven sprays or steel wool that may scratch or scour the surface. Do not use soap or other detergents. These destroy the catalytic self-cleaning surface of the oven roof. If any residues remain, wipe them off with a damp, soft sponge.



It is best for the catalytic self-cleaning surface that the oven is only opened for short periods.



### CAUTION!

Do not use cloths made of fabric. The lint catches and sticks on the rough surface.

## Accessories

Wash all insertable parts (oven shelf, baking tray, side rails, etc.) after each use and dry well. For easier cleaning, leave to soak for a while.

## Grease filter

1. Clean the grease filter in a solution of hot water and washing-up liquid or in the dishwasher.
2. If dirt has become burnt on, simmer in some water and 2-3 tablespoons of dishwasher detergent.

## Side rails

The left and right-hand side rails can be removed from the oven, so that the side walls of the oven can be cleaned.

### Removing the side rails

First pull the rails away from the oven wall at the front of the oven (1)

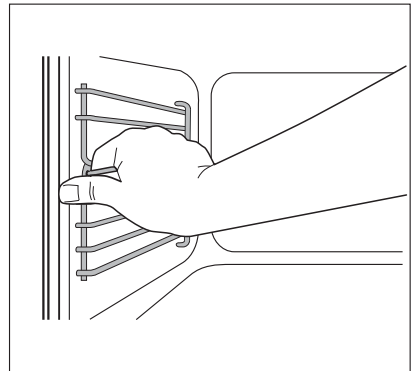

and then unhook them at the back (2).

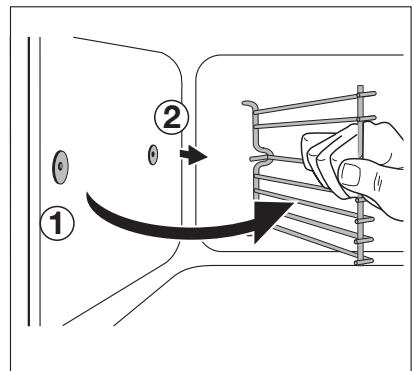

## Replacing the side rails



The rounded ends of the guide bars must point to the front!

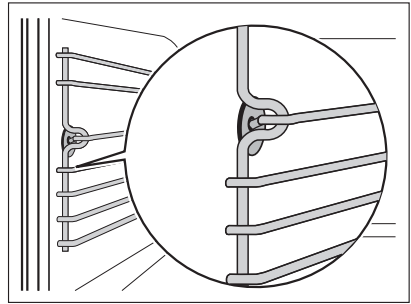

To install, first insert the rails in the holes at the back (1) and then lower into position at the front and press into place (2).

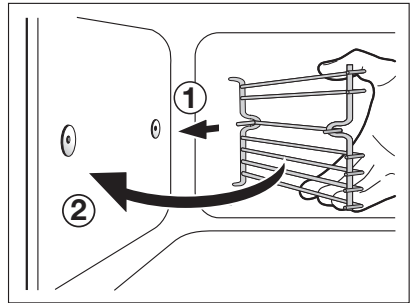

## Oven lighting



### WARNING!

Risk of electric shock! Before replacing the oven light bulb:

- Switch oven off.
- Take the fuses out of the fuse box or switch off.



To protect the oven light bulb and the glass cover, lay a cloth on the floor of the oven.

### Replacing the side oven light bulb/Cleaning the glass cover

1. Take out the side rails on the left.

2. Remove the glass cover with the help of a narrow, blunt object (e. g. a teaspoon) and clean it.
3. If necessary: Replace bulb with a 25 Watt, 230 V, 300°C heat-resistant oven light bulb.

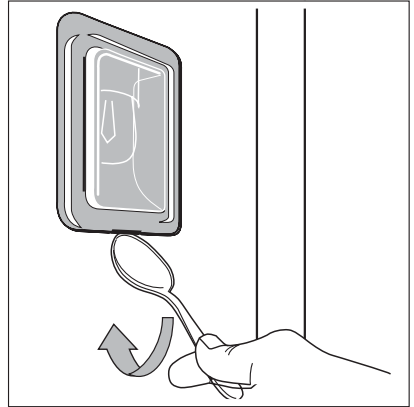

4. Re-fit the glass cover.
5. Replace the side rails.

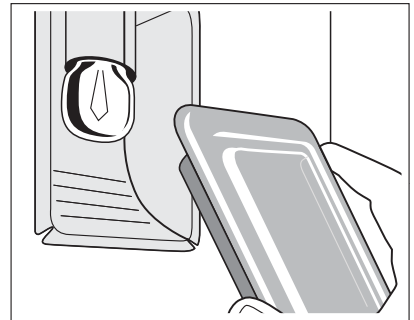

## Oven door

The oven door of your appliance can be taken off its hinges for cleaning.

## Removing the oven door from its hinges

1. Open the oven door as far as it will go.
2. Undo the **clamping levers** on both door hinges **fully**.
3. Take hold of the oven door on the sides with both hands and close it about 3/4 of the way **through the point of resistance**.
4. Pull the door away from the oven. (**Take care:** it is heavy.)
5. Lay the door with the outer side facing downwards on something soft and level, for example, a blanket in order to prevent scratches.

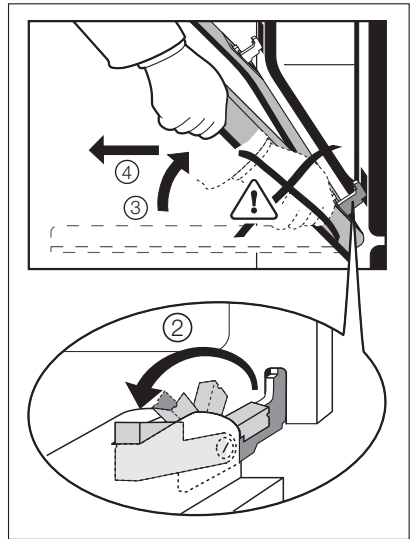

## Hanging the oven door back on its hinges

1. With the face of the door with the handle on it towards you, take hold of the sides of the door with both hands.
2. Hold the door at an angle of approx. 60°.
3. Push door hinges **at the same time** into the two recesses at the bottom of the oven on the left and the right, as far as they will go.
4. Lift the door up to the point of resistance and then open it completely.
5. Fold up the clamping levers on both door hinges back into their original positions.
6. Close the oven door.

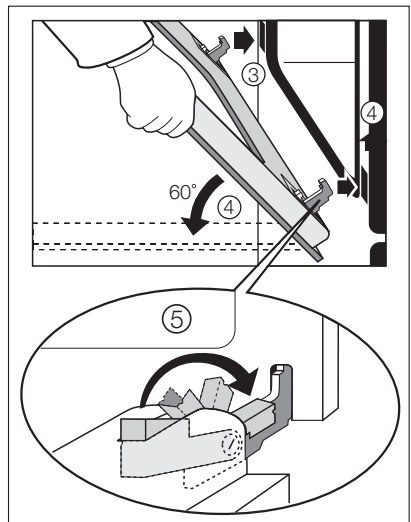

## What to do if...

Problem	Possible cause	Remedy
The oven is not heating up	The oven has not been switched on	Switch oven on
	The clock has not been set	Set the current time on the clock
	The required settings have not been made	Check the settings
	The oven's automatic switch-off has been triggered	See Automatic switch-off
	The child safety device is activated.	Deactivate the child safety device
The oven lighting is not operating	The house wiring fuse (in the fuse box) has tripped	Check fuse. If the fuses trip several times, please call a qualified electrician.
	The oven light bulb is faulty	Replace oven light bulb
"d" is lit in the display and the oven is not heating up. Fan not operating	Test mode is switched on	Switch off the appliance. Press and hold the <b>P</b> and <b>+</b> buttons at the same time, until signal sounds and "d" display goes out

**If you are unable to remedy the problem by following the above suggestions, please contact your local Service Force Centre.**



### **WARNING!**

Repairs to the appliance must only be carried out by qualified service engineers. Considerable danger to the user may result from improper repairs.



In the event of incorrect operation, visits by engineers from Customer Service or the repair may be chargeable, even during the warranty period.



Information for appliances with metal fronts: Due to the cool front of your appliance, there may be short-term condensation of the inner door glass after opening the door, during or shortly after baking or roasting.

# Installation instructions



## CAUTION!

The new appliance may only be installed and connected by a qualified installation engineer. Please comply with this instruction. If you do not, any damage resulting is not covered by the warranty.

To prevent future hazards, damaged mains cables must be replaced by your local Service Force engineer or by a qualified service engineer.

## Safety information for the installer

- The set-up of the electrical installation is arranged so that the appliance can be isolated from the mains with a minimum 3 mm all-pole contact separation. Suitable separation devices include e. g. cut-outs, fuses (screw fuses are to be taken out of the holder), RCDs and contactors.
- The site must provide a connection to the electrical supply by means of a socket that is accessible and outside the configuration space.
- Anti-shock protection must be provided by the installation.
- The built-in unit must meet the stability requirements of DIN 68930.

1a

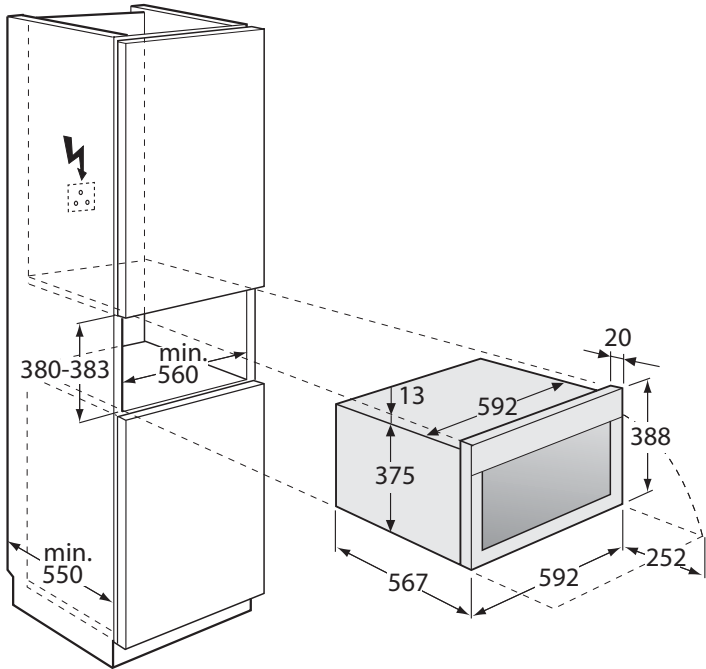

1b

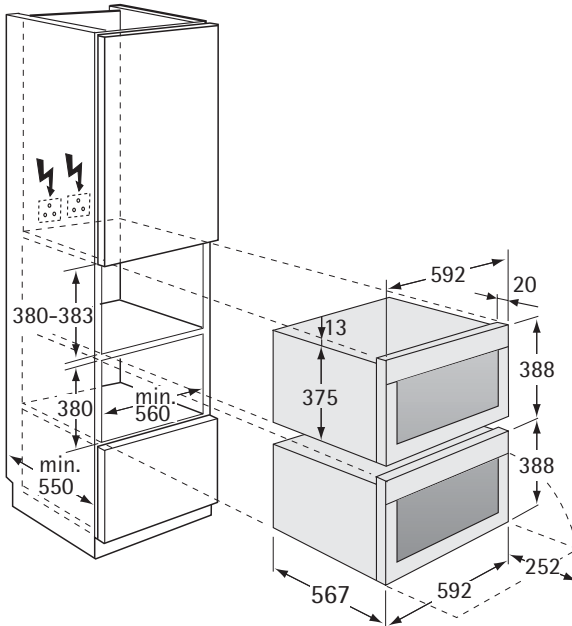



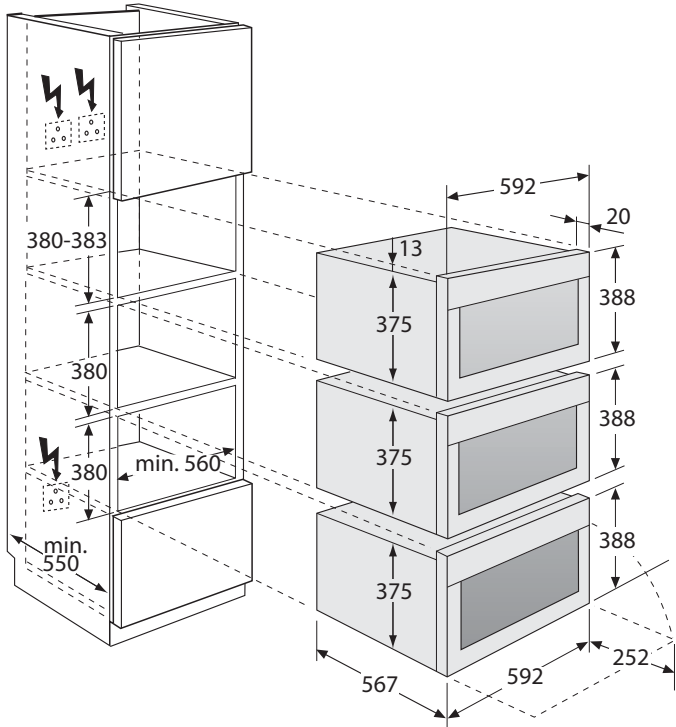

1c

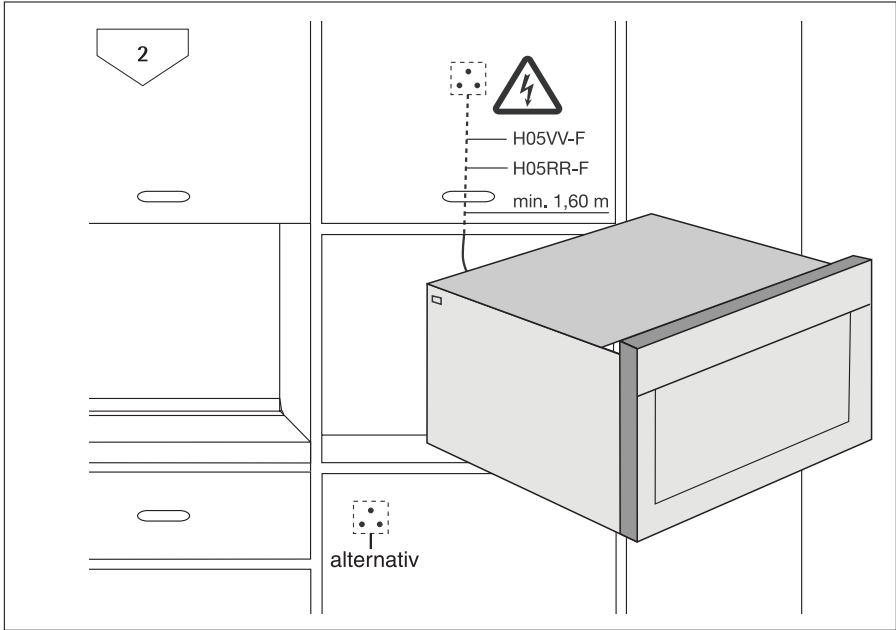

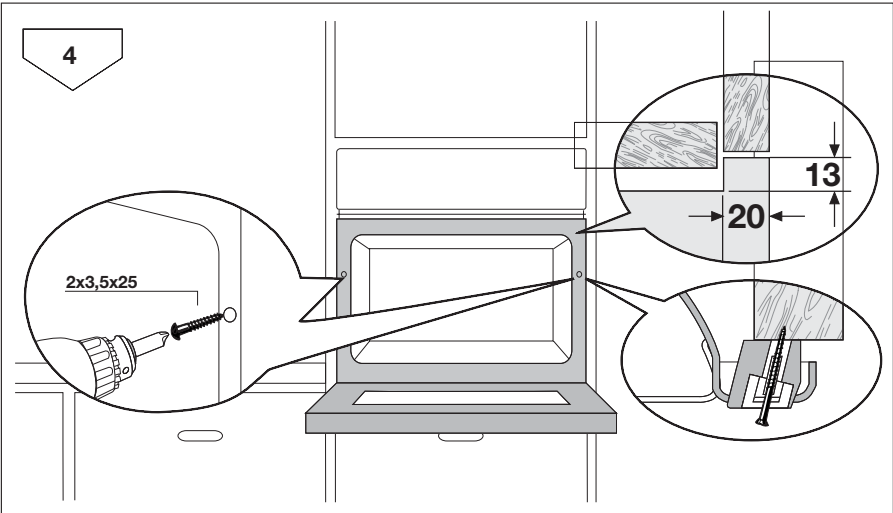
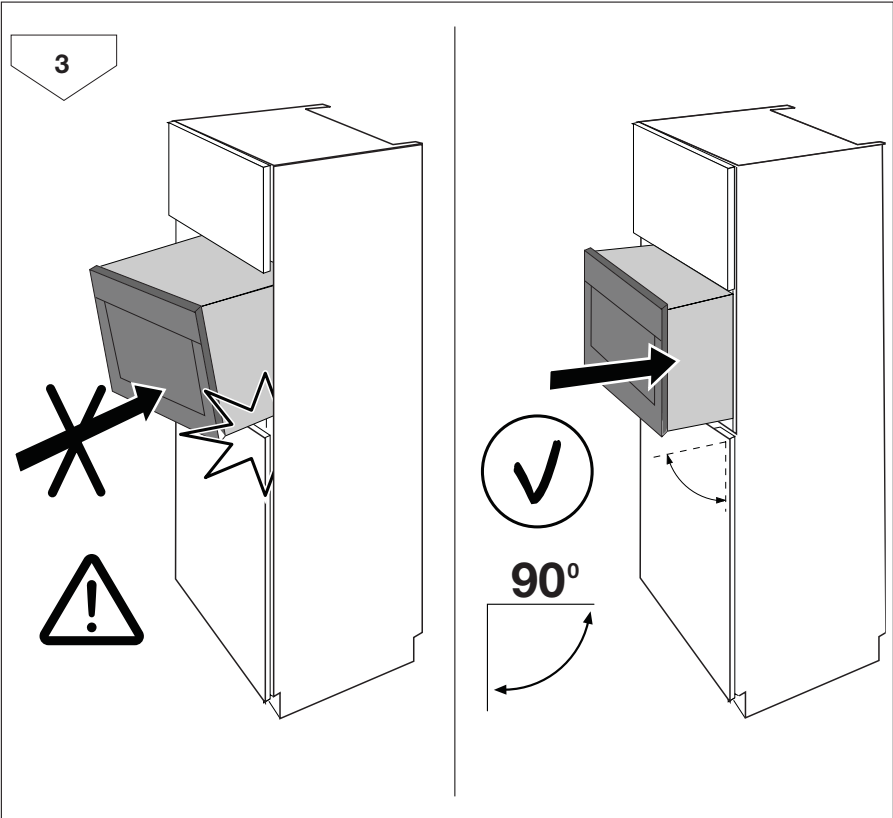



## Disposal

The symbol  on the product or on its packaging indicates that this product may not be treated as household waste. Instead it should be taken to the appropriate collection point for the recycling of electrical and electronic equipment. By ensuring this product is disposed of correctly, you will help prevent potential negative consequences for the environment and human health, which could otherwise be caused by inappropriate waste handling of this product. For more detailed information about recycling of this product, please contact your local council, your household waste disposal service or the shop where you purchased the product.



### Packaging material

The packaging material is environmentally-friendly and recyclable. Plastic parts are marked with the international abbreviations such as, e.g. >PE<, >PS< etc. Dispose of the packaging material in the containers provided for this purpose at your local waste management facility.



### **WARNING!**

Your appliance should be made inoperable before it is disposed of, so that it does not constitute a danger.

To do this, take the mains plug from the socket and remove the mains cable from the appliance.

## Guarantee/Customer Service

### GREAT BRITAIN & IRELAND

#### **Standard guarantee conditions**

We, Electrolux, undertake that if within 12 months of the date of the purchase this Electrolux appliance or any part thereof is proved to be defective by reason only of faulty workmanship or materials, we will, at our option repair or replace the same **FREE OF CHARGE** for labour, materials or carriage on condition that:

- The appliance has been correctly installed and used only on the electricity supply stated on the rating plate.
- The appliance has been used for normal domestic purposes only, and in accordance with the manufacturer's instructions.

- The appliance has not been serviced, maintained, repaired, taken apart or tampered with by any person not authorised by us.
- Electrolux Service Force Centre must undertake all service work under this guarantee
- Any appliance or defective part replaced shall become the Company's property.
- This guarantee is in addition to your statutory and other legal rights.

### **Exclusions**

- Damage or calls resulting from transportation, improper use or neglect, the replacement of any light bulbs or removable parts of glass or plastic.
- Costs incurred for calls to put right an appliance which is improperly installed or calls to appliances outside the United Kingdom.
- Appliances found to be in use within a commercial environment, plus those which are subject to rental agreements.
- Products of Electrolux manufacturer that are not marketed by Electrolux

### **Service and Spare Parts**

In the event of your appliance requiring service, or if you wish to purchase spare parts, please contact your local Service Force Centre by telephoning

**0870 5 929 929**

Your telephone call will be automatically routed to the Service Force Centre covering your postcode area.

For the address of your local Service Force Centre and further information about Service Force, please visit the website at

**[www.serviceforce.co.uk](http://www.serviceforce.co.uk)**

Before calling out an engineer, please ensure you have read the details under the heading "What to do if..."

When you contact the Service Force Centre you will need to give the following details:

1. Your name, address and postcode.
2. Your telephone number.
3. Clear concise details of the fault.
4. The model and Serial number of the appliance (found on the rating plate).
5. The purchase date.

Please note a valid purchase receipt or guarantee documentation is required for in guarantee service calls.

## Customer Care

For general enquiries concerning your Electrolux appliance, or for further information on Electrolux products please contact our Customer Care Department by letter or telephone at the address below or visit our website at [www.electrolux.co.uk](http://www.electrolux.co.uk)  
Customer Care Department Electrolux Major Appliances Addington Way Luton Bedfordshire, LU4 9QQ

	Tel:
Electrolux	08705 950 950 (*)
AEG-Electrolux	08705 350 350 (*)
Zanussi-Electrolux	08705 727 727 (*)

(\*) Calls may be recorded for training purposes

**For Customer Service in The Republic of Ireland please contact us at the address below:**

Electrolux Group (Irl) Ltd Long Mile Road, Dublin 12, Republic of Ireland Tel: +353 (0)1 4090751 Email: [service.eid@electrolux.ie](mailto:service.eid@electrolux.ie)

## European Guarantee

This appliance is guaranteed by Electrolux in each of the countries listed at the back of this user manual, for the period specified in the appliance guarantee or otherwise by law. If you move from one of these countries to another of the countries listed, the appliance guarantee will move with you subject to the following qualifications:-

- The appliance guarantee starts from the date you first purchased the appliance which will be evidenced by production of a valid purchase document issued by the seller of the appliance.
- The appliance guarantee is for the same period and to the same extent for labour and parts as exists in your new country of residence for this particular model or range of appliances.
- The appliance guarantee is personal to the original purchaser of the appliance and cannot be transferred to another user.
- The appliance is installed and used in accordance with instructions issued by Electrolux and is only used within the home, i.e. is not used for commercial purposes.

- The appliance is installed in accordance with all relevant regulations in force within your new country of residence.

The provisions of this European Guarantee do not affect any of the rights granted to you by law.

www.electrolux.com

		
Albania	+35 5 4 261 450	Rr. Pjeter Bogdani Nr. 7 Tirane
Belgique/België/Belgien	+32 2 363 04 44	Bergensesteenweg 719, 1502 Lembeek
<b>Česká republika</b>	<b>+420 2 61 12 61 12</b>	<b>Budějovická 3, Praha 4, 140 21</b>
Danmark	+45 70 11 74 00	Sjællandsgade 2, 7000 Fredericia
Deutschland	+49 180 32 26 622	Muggenhofer Str. 135, 90429 Nürnberg
<b>Eesti</b>	<b>+37 2 66 50 030</b>	<b>Pärnu mnt. 153, 11624 Tallinn</b>
España	+34 902 11 63 88	Carretera M-300, Km. 29,900 Alcalá de Henares Madrid
France	www.electrolux.fr	
Great Britain	+44 8705 929 929	Addington Way, Luton, Bedfordshire LU4 9QQ
Hellas	+30 23 10 56 19 70	4, Limnou Str., 54627 Thessaloniki
<b>Hrvatska</b>	<b>+385 1 63 23 338</b>	<b>Slavonska avenija 3, 10000 Zagreb</b>
Ireland	+353 1 40 90 753	Long Mile Road Dublin 12
Italia	+39 (0) 434 558500	C.so Lino Zanussi, 26 - 33080 Porcia (PN)
<b>Latvija</b>	<b>+37 17 84 59 34</b>	<b>Kr. Barona iela 130/2, LV-1012, Riga</b>
Lietuva	+370 5 278 06 03	Ozo 10a, LT-08200 Vilnius

		
Luxembourg	+352 42 431 301	Rue de Bitbourg, 7, L-1273 Hamm
Magyarország	+36 1 252 1773	H-1142 Budapest XIV, Erzsébet királyné útja 87
Nederland	+31 17 24 68 300	Vennootsweg 1, 2404 CG - Alphen aan den Rijn
Norge	+47 81 5 30 222	Risløkkvn. 2 , 0508 Oslo
Österreich	+43 18 66 400	Herziggasse 9, 1230 Wien
Polska	+48 22 43 47 300	ul. Kolejowa 5/7, Warszawa
Portugal	+35 12 14 40 39 39	Quinta da Fonte - Edifício Gonçalves Zarco - Q 35 -2774-518 Paço de Arcos
Romania	+40 21 451 20 30	Str. Garii Progresului 2, S4, 040671 RO
Schweiz - Suisse - Svizzera	+41 62 88 99 111	Industriestrasse 10, CH-5506 Mägenwil
Slovenija	+38 61 24 25 731	Gerbičeva ulica 98, 1000 Ljubljana
Slovensko	+421 2 43 33 43 22	Electrolux Slovakia s.r.o., Electrolux Domáce spotrebiče SK, Seberíniho 1, 821 03 Bratislava
Suomi	<a href="http://www.electrolux.fi">www.electrolux.fi</a>	
Sverige	+46 (0)771 76 76 76	Electrolux Service, S:t Göransgatan 143, S-105 45 Stockholm
Türkiye	+90 21 22 93 10 25	Tarlabası caddesi no : 35 Taksim İstanbul
Россия	+7 495 937 7837	129090 Москва, Олимпийский проспект, 16, БЦ "Олимпик"
Україна	+380 44 586 20 60	04074 Київ, вул.Автозаводська, 2а, БЦ "Алкон"



# Service

In the event of technical faults, please first check whether you can remedy the problem yourself with the help of the operating instructions (section "What to do if...").

If you were not able to remedy the problem yourself, please contact the Customer Service Department or one of our service partners.

In order to be able to assist you quickly, we require the following information:

- Model description
- Product number (PNC)
- Serial number (S-No.) (for numbers, see rating plate)
- Type of fault
- Any error message displayed by the appliance

So that you have the necessary reference numbers from your appliance at hand, we recommend that you write them in here:

Model description: .....

PNC: .....

S-No: .....

# Index

## A

---

Accessories	10
Additional functions	17

## B

---

Bakes and Gratins	31
Baking	26 30
Baking and Roasting Programmes	17
baking tray	16
Baking tray	10
Button Beep	26

## C

---

Child safety device	25
Cleaning	
Oven roof	49
Accessories	49
Grease filter	50
Initial cleaning	11
Oven interior	48 49
Side rails	50
clock	11
Clock functions	19
Control panel	9

## D

---

Defrosting	36
Door	52
Drying	37

## G

---

grease filter	17
Grill	35

## I

---

Inserting the oven shelf:	17
---------------------------	----

## L

---

Lighting	51
Low temperature cooking	34

## M

---

Making preserves	37
Memory function	18

## O

---

Oven	
Accessories	10
Functions	16
Operation	12
Oven shelf	10

## R

---

Ready Meals	31
Recipes	39
Repairs	6
Roasting	32
Rotitherm Roasting	36

## S

---

Safety	6
Selecting a programme	17
Side rails	50
Switching off the display	24

## T

---

test mode	12
-----------	----



[www.electrolux.com](http://www.electrolux.com)



[www.aeg-electrolux.co.uk](http://www.aeg-electrolux.co.uk)

315 7850 13-D-30062007