

# **COOKER HOBS**

**Gas            KG 74**

**Mixed        KM 74 T**

**Electric      K 74 T**

**AEG TELEFUNKEN (UK) LTD.,**

**Bath Road,**

**Slough,**

**Berkshire**

**SL 1 4 AW**

**Tel : Slough 872101**

# Index

<b>INSTRUCTIONS FOR USE</b> .....	3
– Description .....	3
<b>APPLICATION :</b>	
– Gas burners .....	4
– Automatic plates .....	5
<b>SUITABLE PANS</b> .....	6
<b>MAINTENANCE</b> .....	7
<b>INSTRUCTIONS FOR INSTALLING</b> .....	
Casing .....	8
Fitting air-tight seal .....	8
Fitting the hob .....	8
Gas connection and settings : .....	9-10
Electrical connection .....	11

---

## Guarantee

AEG-Telefunken (UK) Ltd guarantee to replace - free of charge - for one year, to the first retail purchaser, any parts or components which fail due to workmanship or materials.

AEG-Telefunken (UK) Ltd will not replace or repair at no cost defects or poor performance which are due to misuse, accident, tampering with, neglect, faulty installation or damage, however caused.

In order to establish the date of purchase, the invoice, advice note or similar document has to be produced whenever the guarantee is claimed.

These conditions do not in any way replace or detract the customer's statutory rights under common law.

**IMPORTANT :** If placing an order for spare parts, please specify the colour and model No. to our AEG stockist.

AEG-TELEFUNKEN (UK) LTD  
Head Office  
217 Bath Road  
Slough  
Berkshire SL1 4AW

# Description

## Gas hob :

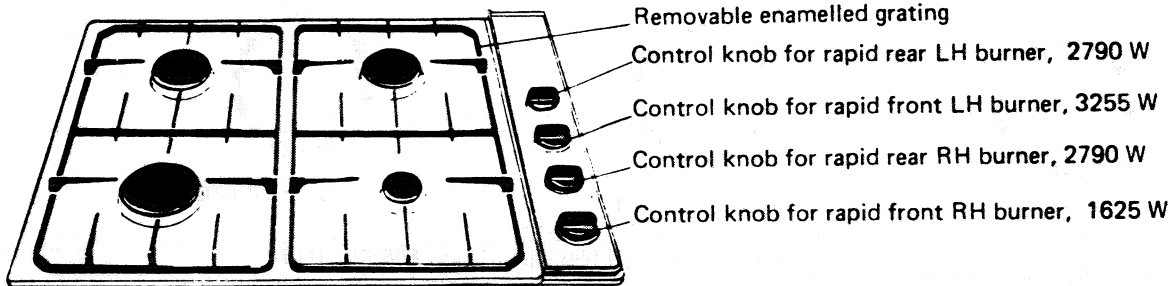

## Mixed hobs :

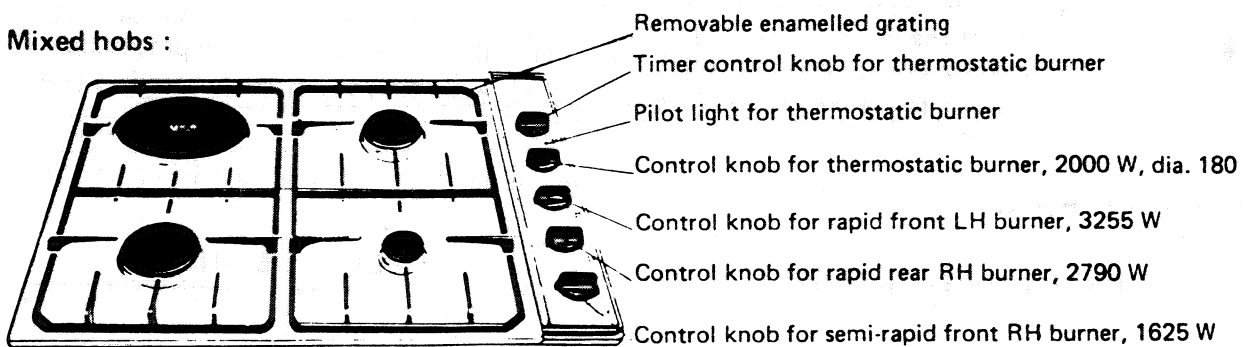

## Electric hob :

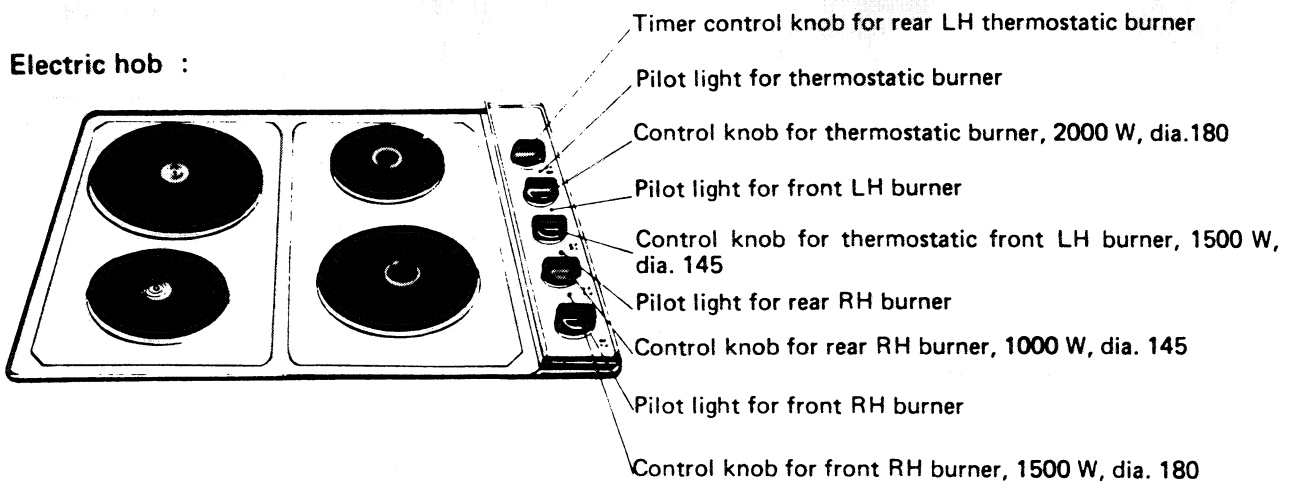

If there is a drawer below the hob, avoid to put inside fragile things, such a plastics, spray cars and so on...

# Use of the gas burners

## OPERATION

A guide mark above each control indicates which burner is being used.

Each burner is supplied with gas by a tap which incorporates a safety catch and a slow burning position.

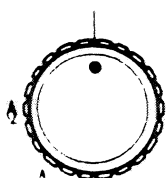

OFF

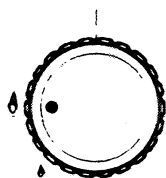

HIGH FLAME

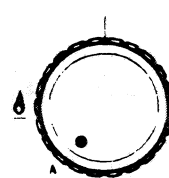

LOW FLAME

Intermediate positions are available between the high and low points on the control.

## LIGHTING THE BURNERS :



- Turn on the gas tap
- Depress and turn the control knob of the burner anticlockwise until it is opposite the high flame mark.
- Press the ignition button, then release it. This produces the sparks and ignites the burner. If the burner fails to ignite after a few seconds, switch of the control knob for 2-3 mins to allow the escaping gas to dissipate, then repeat the ignition procedure.
- If the jets are greasy or damp, the burner may fail to ignite. Always keep them clean and dry.

**IMPORTANT :** When the burners are not in use, the general supply tap must always be turned off.

CHOICE OF SAUCEPANS		FLAME HEIGHT	
<p>Small burner = small pan</p> <p>Saucepans of less than 14 cm dia</p>	<p>Large burner = large pan</p> <p>Saucepans of 14 cm dia or more</p>	<p>Burner hidden</p> <p>WRONG Gas being wasted</p>	<p>Lid in position as for to lid</p> <p>CORRECT Flames do not over shoot saving on gas consumption</p>

The gas and mixed cooker hobs are fitted with burners of different sizes and outputs.

It is important to know how to make use of the resulting differences in power :

- Use the highest out put to bring to boil, to seal meat and generally all foods which must be cooked rapidly.
- Use the small burner for stews and sauces

Avoid cooking by boiling too rapidly. Boiling fast does not cook quicker ; on the contrary, foods are stirred up so quickly that they lose their flavour.

# Use of the hotplates

## SEVEN-SETTING BURNER

This burner is controlled by a knob with six settings (+ off setting) which allows the power to be set according to the type of cooking.

### USE

Turn the burner control knob either to the left or to the right to the setting selected for cooking.

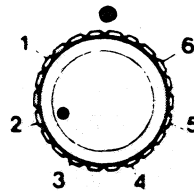

Control knob

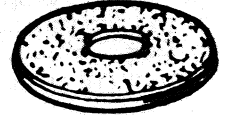

1 kW burner, seven-setting

To succeed in cooking, it is recommended to start off at the high setting (6) and to decrease it to lower setting, taking into account the type and volume of food.

## THERMOSTATIC BURNER

This burner automatically controls the temperature according to the setting of the control knob, using the thermostat. The thermostat sensor must be in contact with the bottom of the saucepan throughout cooking.

### USE

Turn the control knob clockwise to the setting selected for cooking.

Turn it counterclockwise to turn it off.

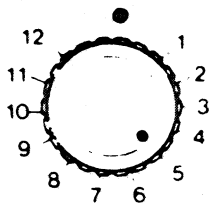

Burner control knob

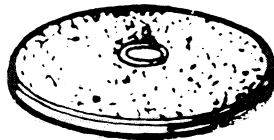

Thermostatic burner  
2 kW dia 180

## REAR LH THERMOSTATIC BURNER WITH TIMER

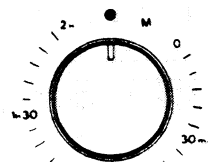

### Manual use :

Set the timer control to «M».

This allows the thermostatic burner to be used without the timer.

### Use with timer :

Set the timer knob to the time desired (up to 2 hours)

Turn the burner control knob to the setting selected for cooking.

The burner turns off automatically when the time set on the timer has run out.

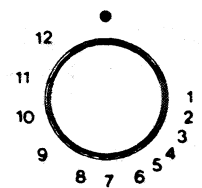

**EXAMPLE :** Set a saucepan on the burner and, taking into account the cooking rate and amount of food, select a setting based on the table below. Cooking then starts off rapidly at full power and the heat is regulated automatically by the thermostat without requiring manual intervention. Very rapidly, after becoming familiar with these settings, you will get into the habit of cooking without supervision.

Turn off the burner a few minutes before cooking is finished to cook «free» with the accumulated heat.

The various temperature settings correspond approximately to the uses given in the table below :

SETTINGS FOR BURNER WITH SEVEN SETTINGS			SETTINGS FOR THERMOSTATIC BURNER	
VERY LOW	1	To keep food warm Melted butter, chocolate, yoghurt	1 - 2	VERY LOW
LOW	2	Cooking of sauces and stews Rice pudding, fried eggs	3 - 4	LOW
SLOW	3	Dried vegetables, frozen food lées Fruit, boiling of water or milk lait	5 - 6	SLOW
MEDIUM	4	Steaming of potatoes, fresh vegetables Noodles, soups, irish stew, pancakes, fish	7 - 8	MEDIUM
HIGH	5	Stewing at higher heat, roulade, tripe, fish, omelette, steak	9 - 10	HIGH
STRONG	6	Steak, scallops, fried food Cook and roast	11 - 12	STRONG

Pilot lights are provided to indicate operation of each of the burners.

They come on whenever the burners are on.

# Suitable pans

Before using the electric hotplates for the first time heat them up for several minutes whilst empty (without saucepan) on the maximum setting to allow the protective coating to harden.

To obtain complete satisfaction from your appliance, it is absolutely necessary to take some precautions or to keep to certain regulations, for example.

**USE OF HEAVY PANS WITH LEVEL BASES (or a raised base)**

DISTORTED PANBASELEVEL PAN BASE

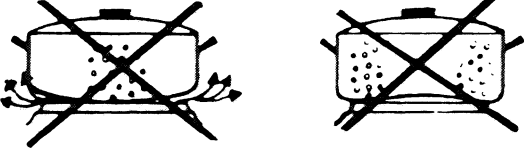

WRONG

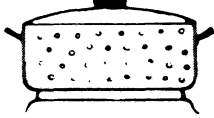

CORRECT

The absolutely flat base eliminates the overheated points of the cooking food, and the thickness of the metal allows an even distribution of heat.

**USE OF PANS WITH A LARGE ENOUGH DIAMETER TO COMPLETELY COVER THE HOT-PLATE**

WRONGCORRECT

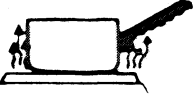

Wasting power



If the saucepan boils over, the hotplate will become soiled and more difficult to clean

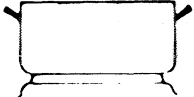



Complete use of the heat



If the pan overflows or brims over, the hotplate is clear so that the spillage can be easily removed from the hob surface

**ENSURE THAT THE BASES OF THE PANS ARE DRY :**





WRONG



Before putting a pan on the hot, ensure that the bottom is completely dry to give good contact to the hotplate.

Never use the same utensils on gas burners and electric hotplates. Because of the heat concentration, the gas burner distorts the base of pans (even the thickest). In this case you would never be able to obtain satisfactory results again when using this pan on an electric hotplate.

Never allow electric plates to operate without a saucepan on it. When this happens, they will heat up to a maximum and become misshapen which will not give satisfactory cooking results.

**IMPORTANT :** Remember to turn off the power a few minutes before you have finished cooking, so that the final cooking can be done «Free of charge» on the heat which has been accumulated. In the same way, a well-covered stewpan allows for cooking at a lower temperature. Cooking in this made more economical.

# Maintenance

## THE BURNER CAPS

These are not fixed, so they may be simply removed and cleaned with a slightly soapy, moist sponge, or a cleaner such as «Jif».

Do not put them into cold water immediately after use, to avoid thermal shock causing a breakage of the enamel.

The use of abrasive products is not advisable, these will scratch and tarnish the enamel. If the holes are clogged, brush the caps with soapy water and dry them with a clean cloth.

## THE ELECTRIC HOTPLATES

Wipe off the burner soilage. If necessary clean the plates with a light abrasive, dry plates thoroughly, preferably turn to the lowest setting for a short time, until dry.

To maintain the shiny appearance rub a drop of neutral oil, such as sewing machine oil, into the surface of the hotplate.

## THE CONTROL PANEL

To ensure the control panel retains its appearance, avoid rubbing it with abrasive products or with a cloth that is dry and dirty. Use a moist sponge which is slightly seapy, and then dry with a suitable clean cloth. To make this easier the control knobs can be removed by pulling them upwards. Do not force the flanging. If the knob is tight, pass a cloth behind the body of the knob and then pull on the cloth.

## THE ENAMELLED PARTS

Never use abrasive products or sharp objects. The enamel can be irreparably damaged. Clean them in soapy water or a little «Jif» when the appliance is cold, then wipe them with a clean, dry cloth.

Cleaning the enamel whilst hot, tarnishes its appearance.

## STAINLESS STEEL PARTS

Use any of the normal branded stainless steel cleaning agents such as «Jif» for maintaining the stainless steel parts of the knob.

# Installation

## UNPACKING OF THE RANGE

Remove the cardboard box and styrofoam padding.

The bag containing the injectors and brackets is attached to the power supply cable for gas and mixed hobs.

The bag containing the attachment brackets is glued to the box of the electric hob.

## FITTING IN CABINET

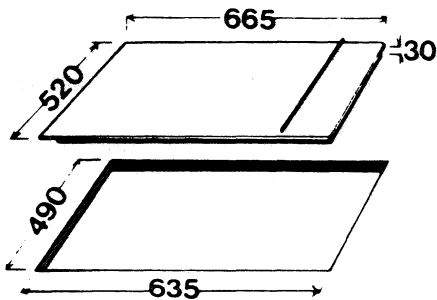

The cabinet or support in which the hob is to be fit, as well as the walls of any cabinet next to it must be either capable of withstanding a temperature of 100°C or covered with a material capable of withstanding this temperature, bonded with a glue which has good heat resistance in order to avoid unbonding.

Do not enclose less than 1 cm beneath the box so as not to disturb proper circulation of air around it.

The cutout must be at least 80 mm away from a vertical wall located above the work surface.

## ATTACHMENT OF THE HOB :

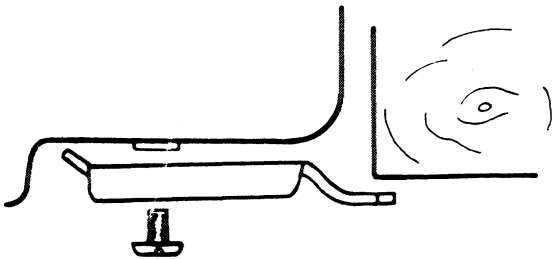

The hob box is fitted underneath with seven locations for the attachment brackets designed to attach it to the cabinet

- Install the four attachment brackets so that the hob surface is fully applied against the support cabinet.

**IMPORTANT :** It is recommended to blank the holes of the locations which are not used with the remaining screws, except for the electric hob.



# Connecting and adjusting the gas

## GAS CONNECTION

Appliances incorporated into kitchen units must be connected by means of a rigid pipe. The cooker hobs for building-in are therefore supplied without nozzle for a flexible pipe.

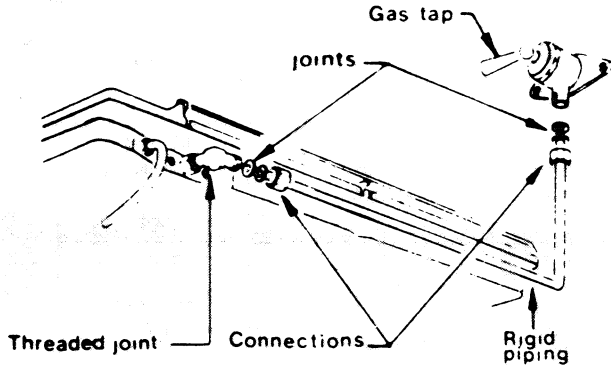

Connect with iron or copper piping starting from the threaded joint fixed on the edge of the cooker hob.

Make provision for a connection that can be taken apart and is easily accessible.

**NOTE :** If you need to redirect the threaded joint, it is possible to unscrew lightly the nut which fixes it to the edge. After doing this, screw up the nut carefully to ensure an airtight seal of the joint.

## ADJUSTING THE BURNERS

The hob is regulated in the factory for a specific type of gas. The nature of this gas is marked on the labels affixed to the packing. In case it is to be used with another gas, it is necessary to adapt the appliance.

**NOTE :** The necessary injectors for conversion to the different gases, other than those on the appliance, are supplied with the hob.

## REPLACING THE INJECTORS

### REPLACEMENT OF INJECTORS :

To replace the injectors, it is necessary to :

- remove the control panel and cook top
- remove the burner body.

### Removal of control panel :

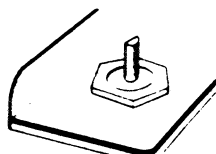
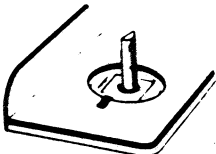

- Remove the knobs.
  - remove the clip next to the first valve (gas or mixed hob).
- Or :
- remove the nut on the first switch (electric hob)

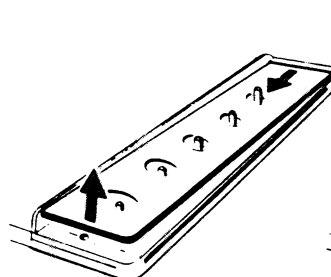

- Release the control panel glass engaged in the rear end piece.

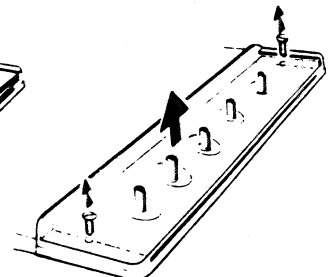

- Unscrew the two attaching screws at each end of the control panel.
- remove the panel.

### Removal of hob cooktop

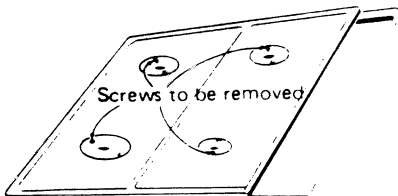

- Remove the control panel,
- Remove the control panel
- unscrew the screw attaching each burner head and remove the hob cook top by slightly raising it and pushing it slightly to the side opposite the strip in order to release the lower folds.

### Removal of burner bodies and replacement of injectors :

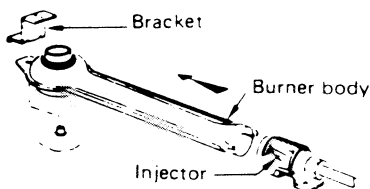

- Remove the screw attaching each of the injector bodies.

Use a 7 mm wrench to remove the injectors.

Install the injectors corresponding to the gas burner.



CHARACTERISTICS OF GAS BURNERS	Butane	Propane	Natural gas (20 mbar)
Heat rate MJ/m <sup>3</sup> Service pressure mbar	133,1 28	101,8 37	39,9 18
<b>SEMI-RAPID BURNER</b> Injector number Thermal output kW Output per hour (g/h) 15°C, 760 mm Hg (l/h)	A(63) 1,63 119	A(63) 1,63 116	C(93) 1,63 156
<b>RAPID BURNER (2.79 kW)</b> Injector number Thermal output kW Output per hour (g/h) 15°C, 760 mm Hg (l/h)	K ( 84) 2,80 203	K (84) 2,80 200	M (128) 2,80 268
<b>RAPID BURNER (3.255 kW)</b> Injector number Thermal output kW Output per hour (g/h) 15°C, 760 mm Hg (l/h)	L (89) 3,25 237	L (89) 3,25 233	N (136) 3,25 312
<b>MAXIMUM TOTAL OUTPUT</b>  g·h l/h	762	749	1004

NOTE : The injector diameters are given for reference.

#### ADJUSTMENT OF AIR RINGS :

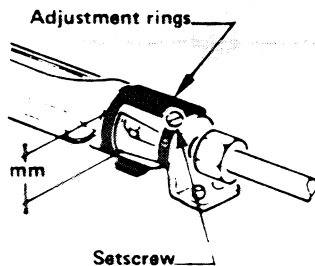

To reach the air rings, it is necessary to raise the cook top. To do so, proceed as indicated for replacement of the injectors (see preceding page).

- Install the burner heads, the screws and the burner caps. Ignite the burners.
- Then unscrew the air ring set screw.
- Adjust by rotating the air ring on the injector holder.
- Tighten the set screw.;
- Install the cook top (after removing the burner heads and caps).

#### OPENING OF AIR RINGS:

Type of gas	BURNERS		
	semi-rapid	rapid 2.79 kW	rapid 3.255 kW
Butane Propane*	Maximum opening		
Natural gas	6 mm	8 mm	10 mm

\*For operation with propane it is preferable to use an air adjustment slightly more closed than for butane.

#### ADJUSTMENT OF LOW FLAME :

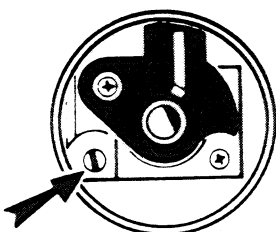

- Remove the control knobs by pulling them up.
- Remove the collars from the control panel, simply engaged on it.
- With the burner lit at minimum flame (small flame mark), it is correctly adjusted when the low flame, about 3 mm high, does not go out when switching from high to low flame.
- If this is not the case, turn on the burner to maximum rate and loosen the adjusting screw by several turns.
- Turn the burner knob to low flame and tighten the adjusting screw until obtaining a correctly adjusted low flame.

# Electrical connection

## GAS HOB

The gas hob are supplied with a cable which should be connected to a standard 13 Amp plug fitted with a 3 Amp fuse

## MIXED HOB

The mixed hob are supplied with a cable which should be connected to a standard 13 Amp plug fitted with a 10 Amp fuse.

## ELECTRIC HOB

This electric hob is equipped with a terminal plate which facilitates connection. It is not available with a cable. The wiring must be made by the installer. Before beginning connecting it is essential to make sure that the voltage is that which is shown on the meter.

## CONNECTION

This hob should be connected to a 30 Amp cooker control unit by means of a 4 mm<sup>2</sup> cable.

Connect cable to the hob in accordance with the following instructions and wiring diagram:

- ① Remove the terminal black cover (fixed to the body by 2 screws).
- ② Pass the mains cable through the cable clamp and then into the aperture in the cover.
- ③ Connect the mains cable to the terminals as shown in the wiring diagram. Make sure the appropriate terminals are linked and the earth wire connected.
- ④ Refit the cover and tighten the cable clamp.

