

LAVAMAT 2080

Washer - Dryer

Operating Instructions

Installation Instructions	Page
Transport protection	4
Setting up	5
Worktop	6
Water inlet connection	6
Water drainage connection	6
Electrical connection	7
 Operating Instructions – Washing	
Opening and closing the loading door	8
Door lock	8
Preparation for washing/loading washing	9
Type and quantity of washing powder or liquid	9
Adding detergents and fabric conditioner	10
Preventing over-filling with powder or liquid	11
Softening and starching	11
Facia symbols	12
Programme selection – washing	12
Temperature selection	12
Additional functions	12/13
How to switch the machine on and off	14
Programme sequence indicator – washing	14
Rinse hold	15
Programme end – washing	15
Using the machine for the first time	15
Table of main programmes	16–19
 Operating Instructions – Drying	
Preparation for drying	20
What not to put in the dryer	20
Care symbols – drying	21
Table of programmes – drying	21
Washing weights	21
Facia symbols	22
Programme selection – drying	22
Do not interrupt drying	22
Programme end/switching off	22
After drying	22
 Care and Maintenance	
Drain sieve/lint filter	23
Removal of drain sieve and emergency draining	23
Motor overload protection	23
Care	24
If you think your machine is not working properly	25
Hints for dealing with minor operating problems	25/26
Breakdown – what to do	26

Transport protection

The inner and outer washing drums are supported by springs. To avoid damage during transportation, the drums are secured by bars. These transport bars are on the rear side of the appliance and are marked in red. **These transport bars must be removed before the appliance is operated!**

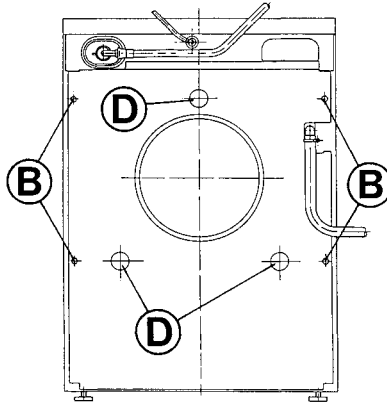
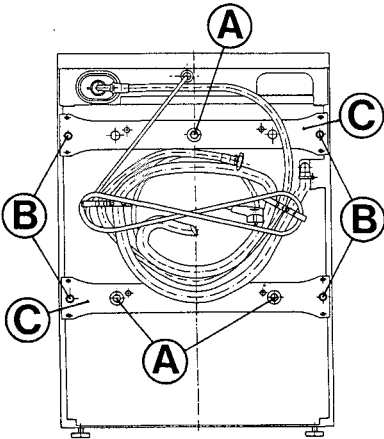
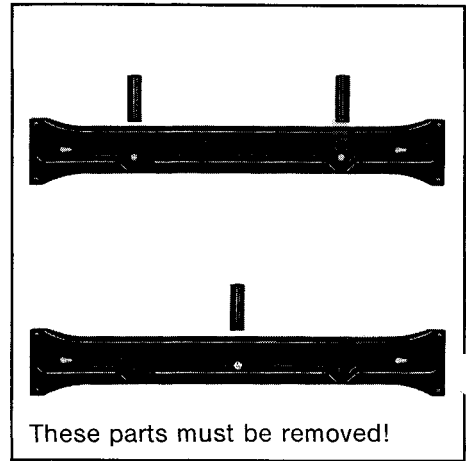

Removal of transport bars

The bars are accessible from the rear of the appliance. Remove first the 3 hexagon screws **A** (17 mm spanner), then the 4 hexagon screws **B** (13 mm spanner), from the rear panel, using the spanner provided (in package with detergent dispenser).

The transport bars **C** can then be pulled from the appliance.

The four screws **B** at the top and bottom should now be screwed back into the appliance. For safety reasons, the three holes **D** left after the bars have been removed should be blanked off with the plastic inserts supplied.

Keep all these parts in a safe place.

In the event that the appliance is transported at some time in the future the transport bars must be refitted, to avoid the possibility of damage.

Do not transport the appliance without the transport bars fitted; remember to remove them before operating the appliance again!

Setting up

The maximum load on the floor where the appliance is installed will be 120 kg. Stand the appliance only on a floor which is firm and capable of bearing this load. Loosely-laid tiles or springy wood boards, for example, are not suitable. If necessary, screw to the floor under the appliance a 2 cm thick piece of strong support board.

The appliance must be set up so that it is horizontal and has all 4 feet standing firmly on the floor. It must not rock when pushed down at opposite corners. This is important for quiet running and for avoiding movement during spinning. Unevenness in the floor can be allowed for by setting the height-adjustable feet (adjustment range +15/-5 mm). The spanner provided for removing the transport bars can also be used to adjust the feet.

- Loosen the locking nut with the provided spanner (17 mm) (Illustration ①).

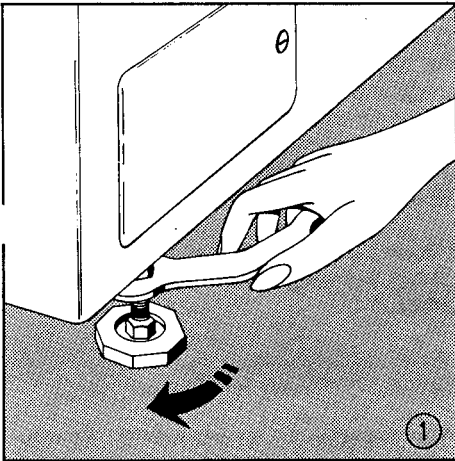

- Screw the feet higher or lower with the spanner (13 mm) until they are all firmly in contact with the floor (Illustration ②).

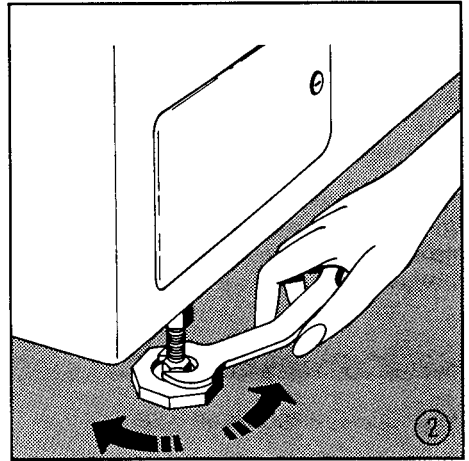

- Tighten the locknut again (Illustration ③).

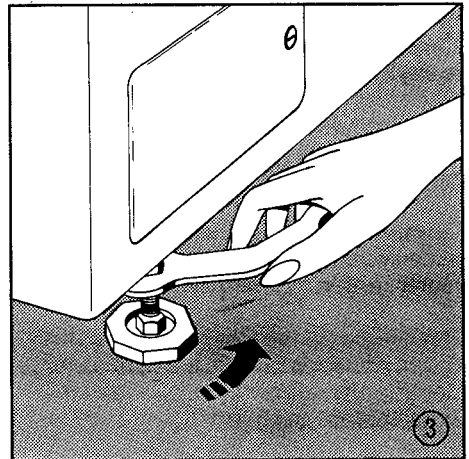

Unevenness in the floor must not be allowed for by packing underneath the feet with wood, paper, or similar.

Installation on floor coverings with high pile, and carpets with soft foam backings, is not acceptable.

Worktop

On models which have a scratch-resistant worktop, this can be removed to allow the appliance to be built under another working surface.

IMPORTANT

A coverplate is supplied with your machine, this should be fitted instead of the original worktop.

Remove the plug from the socket before doing any installation work. The appliance must have no power connected to it.

Water inlet connection

Your machine is cold fill only.

A rigid connection (solid piping) direct to the machine is not permissible.

The washer-dryer can be connected to any water inlet, without a reverse-flow valve. **This appliance meets national regulations (e.g. DVGW in Germany).** Use a normal cold water inlet, with a 1/2" stopcock and G 3/4" hose connection or plug-in water connector. The water pressure must be in the range 10–100 N/cm² (15–145 psi).

Open the stopcock and test the joints between appliance and mains for any leaks under full mains pressure.

Newly-laid water pipes must be thoroughly flushed through before connecting the appliance up, because of possible dirt in them.

To avoid possible damage through water leakage, the mains supply should be turned off at the stopcock when the appliance is not in use (this is particularly important when appliances are built in).

If the existing inlet hose on the rear of the appliance is not long enough, we advise that you do not attempt to extend it but, instead, replace it with the required length of suitable hose which has a bursting pressure of at least 60 bar (870 psi), to meet Standard DIN 44 995.

We further recommend that the inlet hose be examined at regular intervals, to see if it has become cracked or brittle – if it shows such signs of deterioration, it should be replaced by a new hose meeting the above-noted specification.

The appropriate Regulations of the local water authority should be observed.

Water drainage connection

The appliance pumps out at approximately 20 litres per minute, therefore, any sink, standpipe or waste connection must be capable of accepting this amount.

If the outlet hose is placed over a sink, the sink must be kept clear whilst appliance is in use. If using a standpipe the following are the measurement requirements: Maximum pumping height = 100 cm. Minimum internal diameter = 37 mm. Maximum drainage run = 4.5 m.

If connected to a sink waste ensure outlet hose is clipped to the underside of sink top.

When appliance is in place, ensure the outlet is laid free of kinks.

The drainage hose attached to the rear of the appliance has a pivoting connection to allow it to be moved to either side.

Danger of flooding!

If the waste water is drained into a gully in the floor, make sure that the end of the hose is not actually lying in the water, as this creates a syphon effect.

Electrical connection

WARNING – THIS APPLIANCE MUST BE EARTHED

Special requirements for UK

Caution note!

If your appliance has been equipped with a mains lead with a moulded on type plug, you must comply with the following regulations: The plug moulded on to the lead incorporates a fuse. For replacement, use a 13 amp BS 1362 fuse. Only ASTA approved or certified fuses should be used. If the fuse cover/carrier is lost, a replacement cover/carrier must be obtained from electrical goods retailers. If the socket outlets in your home are not suitable for the plug fitted to the appliance, then the plug must be cut off and destroyed for safety reasons, and an appropriate plug fitted.

When fitting the plug please note the following points:

IMPORTANT

The wires in the mains lead are coloured in accordance with the following code:

Green and Yellow	Earth
Blue	Neutral
Brown	Live

As the colours of the wires in the mains lead of this appliance may not correspond with the coloured markings identifying the terminals in your plug proceed as follows:

1. The wire which is coloured Green and Yellow must be connected to the **Earth terminal** in your plug, which is marked with the letter E or by the earth symbol \perp or coloured Green, or Green and Yellow.
2. The wire which is coloured brown must be connected to the **live terminal** which is marked with the letter L or coloured red.
3. The wire which is coloured blue must be connected to the **neutral terminal** which is marked with the letter N or coloured black.

When wiring the plug, ensure that all strands of wire are securely retained in each terminal. Do not forget to tighten the mains lead clamp on the plug. This appliance complies with the requirements laid out in the EEC Directive 76/899.

Voltage 240 V AC

Fuse rating 13 amps

See rating plate for further information.

This appliance meets VDE requirements.

Particular regulations of local electricity authorities must be observed.

This appliance conforms to EEC Directive No. 82/449/EWG on radio interference.

Repairs to electrical appliances may only be performed by trained personnel. Improper repairs may lead to serious risks for the user.

Opening & closing the loading door

Opening

Push the safety button behind the hand grip to the left and pull the grip forwards. **(The door can be opened only when the washing programme selector knob is in the “off” position, or when the appliance is switched off).**

Closing

After loading the washing into the appliance, close the door by lightly pressing it to. The appliance will not operate unless the door is properly closed.

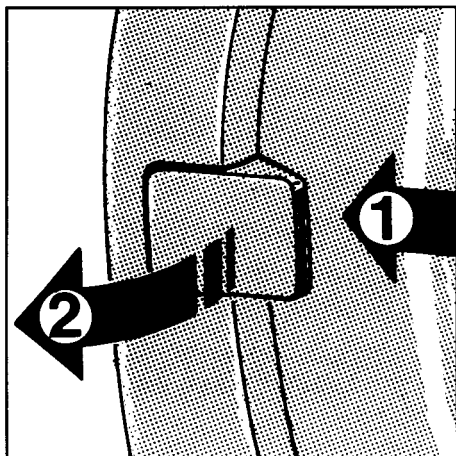

Door lock

For safety reasons, the door is electrically locked throughout the whole of each washing programme. It also remains locked at the end of the Easy-Cares, Delicates and Woollens programmes, at the rinse hold (with high water level), even when the appliance is switched off.

Programmes end with the programme sequence indicator in the “●” position.

In position “●”, the loading door can be opened after a delay of about 90 seconds.

Warning! If there is a power failure, drain the water or suds from the drum through the drain hose which is next to the drain sieve, before opening the door. See Page 23 (Emergency draining).

Preparation for washing

Sort washing according to types of fabric and washing temperature (please observe recommendations given on Care labels). Whenever possible, put articles of different sizes but of the same fabric type and degree of dirtiness together in the same wash. Advice is given in the table of programmes on page 16/17.

In order to avoid damage to the washing, make sure there are no paper clips, hairpins, safety pins, nails, coins, etc left in the articles to be washed. Some articles – e.g. curtains – are made of very sensitive materials. We cannot accept any responsibility for damage that may occur (e.g. stretching or creasing) if they are washed.

Type and quantity of washing powder or liquid

The choice of detergent depends on what types of fabric are to be washed (synthetics, wool, cotton, etc), their colour and the washing temperature. In an automatic washing machine you need to use a low lather washing detergent. We recommend Ariel Automatic which has been specially formulated for automatics.

Always follow the instructions given by the manufacturers of the detergent. The required amount of washing powder/liquid is affected by the hardness of the supply water.

0–7° dH (0–9° Clarke)	= Hardness Range 1, soft
7–14° dH (9–17° Clarke)	= Hardness Range 2, medium
14–21° dH (17–26° Clarke)	= Hardness Range 3, hard
over 21° dH (over 26° Clarke)	= Hardness Range 4, very hard

Information about the degree of hardness of your supply of water can be obtained from the local water authority or council.

When washing only lightly soiled items or there is only a small load, use less detergent. If washing is heavily soiled, or the water hardness is high, use more detergent.

Capacity

Full utilization of the washing capacity will give the most economical operation. The maximum capacity is 5 kg dry weight of lightly – to average soiled washing. For heavily soiled washing, we recommend 4 kg max. For Easy-Care articles 1.5 kg max., and – for woollens and delicates (curtains) – 1 kg max. **Do not exceed these maximum loads, except on the rare occasion when you may wish to wash a blanket on the woollen cycle.**

Loading washing



Load the sorted and unfolded washing loosely into the drum. Wash a mixture of large and small articles, whenever possible. Press the loading door closed until you hear an audible “click”.

Adding detergent and fabric conditioner

Use the measuring cup which is supplied with the washing powder. When washing powder is used, the liquid detergent container must be removed from compartment .

Put all detergent and fabric conditioner (if used) into the dispenser compartments **before** starting a washing programme. The dispenser is on the right side of the control panel, and can be pulled out easily by the hand grip.

The compartments are identified by symbols on their front edges:

-  = prewash compartment
-  = main wash compartment
-  = softener compartment

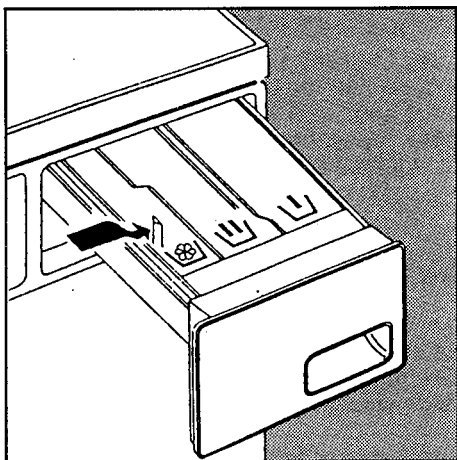

If liquid detergent is used, the provided container must be utilized. This should be inserted into compartment  and the liquid detergent poured into it.

Important:

Do not fill the container right up to the edge with liquid detergent, as this might cause the agent to be dispensed prematurely.

If the detergent has been put in correctly, starting the programme results in water going directly into the drum at first, followed approximately 90 seconds later by automatic flushing of the detergent.

Preventing over-filling with powder or liquid

If too much washing agent is put in, there is a danger of excessive foam being produced.

Too much foam reduces the effectiveness of the washing and unnecessarily increases environmental pollution.

Until you are familiar with the appliance, foaming of the suds should be observed. During the main wash, foam should not rise higher than the middle of the door window; otherwise, washing does not fall freely into the suds when the drum reverses, and the wash is not thorough. Foam thickness of up to about 10 cm is in order but, if it is more than that, so that the upper third or even the whole of the window is covered, the amount of washing agent is too high and must be reduced for the next programme.

Softening & starching

All well-known brands of aftertreatment agent suitable for drum automatics can be used.

Follow manufacturers' instructions for use with a water volume of approx. 15 litres (coloureds programmes) or 20 litres (Easy-Cares programmes).

Put softener or liquid starch into softener compartment ; do not fill above the maximum height indicated by the arrow.

Programme ④ allows larger volumes of starch and impregnating agents to be used. The agent must be poured into the liquid container fitted into compartment  before the start of a programme, in liquid (dissolved) form, following the manufacturers' instructions.

Facia symbols

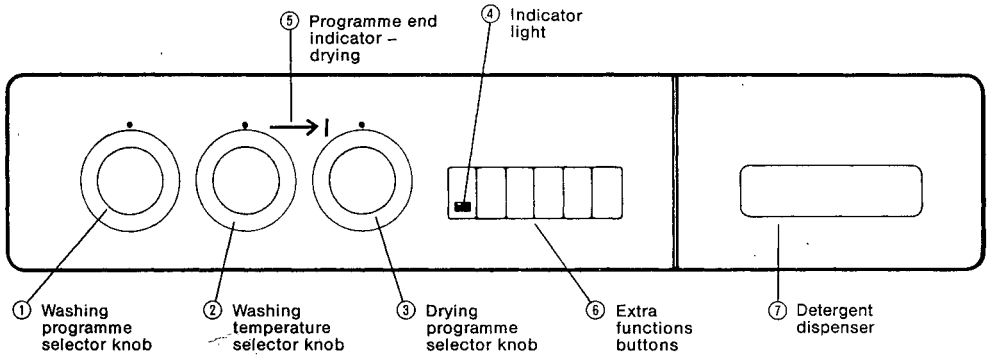

Programme selection – washing

This is done with the Washing Programme Selector Knob ①, which must be turned **only in a clockwise direction, and when it is pressed in** (see direction arrow on the knob). The Programme Number must line up with the marker on the facia above the knob.



Temperature selection

The required washing temperature must be set before a programme is started, using the Washing Temperature Selector Knob ② (see the table of programmes on Page 20/21).

The temperature stated in the table of programmes is the maximum and most effective wash temperature. You do have the flexibility to lower the stated temperature should you wish to do so – maybe for lightly soiled items.

Selection of additional functions

Your model has 5 buttons to enable the selection of additional functions:

1.  Delicates/Easy-Cares button
2.  Woollens button
3.  Energy-saving/Intensive button
4. $\frac{1}{2}$ load button
5. Speed reduction/Short spin button

When these buttons have been pressed in at the start of a programme, their functions are activated during the appropriate stages of the washing programme in use.

At the end of each programme, any buttons which have been pressed in should be released, to avoid incorrect selections taking place in the following programmes. The buttons must be pressed in again to cause them to be released.

Delicates/Easy-Cares button



The Delicates/Easy-Cares button must be pressed in before the start of all delicate and Easy-Cares programmes.

This button reduces the intensity of the washing action in Programmes

①– ④.

Sensitive articles are washed particularly carefully and gently. The washing remains in the final rinse water (rinse stop).

Woollens button



The woollens button must always be pressed in before the start of Programme ②.

This reduces the intensity of the washing action considerably (Woolmark symbol programme). The washing remains in the last rinse water (rinse hold).

Energy-saving/intensive button



The button is effective on all hot and coloureds wash programmes. It has two functions:

Energy saving

The button can be used for lightly soiled loads. Selection of the button and a reduction of the temperature (30–60 °C), extends the wash time by 16 minutes whilst washing at a lower temperature. This together with modern detergents – offers energy-saving washing for lightly soiled loads.

Intensive button

The button can be used, in conjunction with any temperature between 30–95 °C, to select an intensive wash. The extended wash time ensures excellent results for heavily soiled articles.

1/2 load button



By pressing this button, electricity, water and detergents can be saved, if only half a load is to be washed. This button is not effective on the woollens programme, in order to maintain the washing performance.

Short spin/spin reduction button/rinse hold cancel



This button affects the final spin on all programmes. It automatically reduces the normal spin speed from 1100 rpm to 800 rpm. At the same time, the length of the final spin is reduced.

On the Easy-Cares, Delicates and Woollens programmes, pressing this button in causes the rinse hold to be overridden, and the washing is given an anti-crease short spin, appropriate to the type of material being spun.

Note:

If the wash is to be followed by drying, this button must not be pressed in on hot- and coloureds washes, to avoid the washing being too wet for economical drying.

How to switch the machine on and off

Turn the water stopcock on!

Switching on for washing

1. Check the drying programme selector (3) is in the "off" position.
2. Turn the programme selector. (1) clockwise to the required programme, select the required temperature (2) and press any buttons required (see programme guide).
3. Pull out wash programme selector.

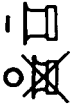

The indicator light (4) will come on and the programme will begin.

Programme Sequence indicator – washing

The Washing Programme Selector knob (1) acts as a Programme Sequence indicator once a programme has started running. The current programme phase can be read from the knob.

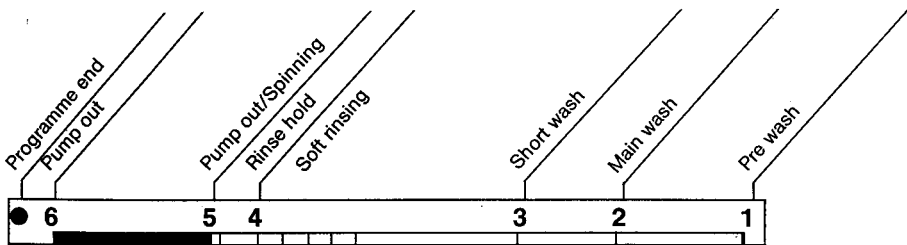

- | | |
|------------------------|--------------|
| 1 prewash | 4 rinse hold |
| 2 main wash | 5 spinning |
| 3 rinsing and spinning | 6 draining |

For normally soiled laundry use a programme **without a pre-wash** (selector programme number 2). For more heavily soiled laundry use a **pre-wash and a main wash** (selector programme number 1) with the **exception of wool**.

Rinse hold – D

At the end of the Easy-Care, Delicate and Woollen programmes, the washing programme selector knob (1) stops in the rinse hold “D” position. The washing remains in the final rinse water to avoid discolouration or creasing. In order to remove the washing at the end of these programmes, the water must be drained by turning to Programme (6), or by pressing in the spin reduction/short spin button 

Programme end – washing



The loading door can be opened approximately 90 seconds after the end of each programme.

a – end for all programmes.

End for all programmes

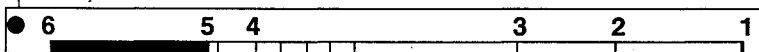





















Turn the water stopcock off if washing and drying is finished, but note that the stopcock must be left on during drying.

Using for the first time

We recommend that you first run one programme without any washing in the appliance. The most suitable programme is (3) (short, coloureds wash without prewash, 30 °C). Use about 1 cup of washing powder, in dispenser compartment , **Removing the container for liquid detergent before hand.**

Main programmes

Textile Care Labelling Code	Fabrics	Type of laundry	Programmes	Load size	Programme Selection		
					① Programme Selector	② Temperature Selector	Button
	White cotton and linen articles without special finishes	Bed and table linen, towels, underwear, white or colourfast	Hot wash	up to 5 kg **)	1 or 2 up to ...		
	Cotton, linen	Coloured blouses, aprons, overalls, shirts, bed linen, towels	Coloureds	up to 5 kg **)	1 or 2 up to ...		
	Cotton, linen	Deep coloured laundry	Coloureds	up to 5 kg **)	1 or 2 up to ...		
	Nylon, polyester/cotton mixtures, viscose, cotton/acrylic mixtures	Sheets, pillow cases, duvet covers, shirts, blouses, skirts, trousers, underwear	Easy-care	up to 1.5 kg	1 or 2 up to ...		
	Acrylics, acetate, triacetate, polyester/wool blends	Jumpers, blouses, dresses, curtains	Delicates	up to 1 kg	2 ...		
 	Wool, including blankets and wool mixtures with cotton or rayon; silk	Machine washable woolens	Wool	up to 1 kg	2 up to ...		
	Cottons, linens	Lightly soiled laundry of any kind (except wool and curtains)	Short wash	up to 5 kg	3	according to wash label	
	Easy-care fabrics, delicates		Short wash	up to 1.5 kg	3	according to wash label 	

Programme Cycle	Note
Pre-wash – main wash – rinses – spinning	1 with pre-wash 2 without pre-wash **) Load size for Lightly to normally soiled laundry 5 kg Heavily soiled laundry 4 kg
Pre-wash – main wash – rinses – spinning	
Pre-wash – main wash – rinses – spinning	*) Rinse Hold Washing remains in final rinse water at end of programme. To short spin – turn the programme selector to setting 5 with buttons  or  +  depressed (pump out and gentle spin.) To pump out only – setting 6.
Pre-wash – main wash (with reduced drum rhythm and high water level) – rinses – rinse hold *)	
Main wash (with reduced drum rhythm and high water level) – rinses – rinse hold *)	
Main wash – fills to high water level – gentle wash action – rinses – rinse hold *)	You can also cancel the Rinse Hold at the beginning of the programme by additionally pressing the button as part of the selection of the easy-care/delicate/woollen programmes. The laundry is then gently spun for only 2 minutes at 800 rpm. Aprox. 1.5 minutes after the spin you can open the door and take the laundry out of the drum.
Short main wash – rinses – spinning	
Short main wash with reduced drum rhythm and high water level – rinses – rinse hold *)	The spin sequences are VARIOMATIC – a sequence of spins with loosening of the laundry in between each spin. This helps to reduce tangling and creasing of the laundry.

Additional programmes

Programme	Laundry	Load size
Soft rinsing – starching – spinning	Cottons and linens	up to 5 kg
Soft rinsing – starching	Easy-care fabrics and delicate synthetics	up to 1.5 kg
Spinning	Cottons and linens	up to 5 kg
Pump out – short spin	Easy-care fabrics, delicate synthetics	up to 1.5 kg
	Woollens	up to 1.5 kg
Pump out	For laundry which should not be spun	





This appliance is equipped with an electronic control system which will evenly balance the load before spinning ensuring a quiet and smooth spin.

Should the machine be unable to balance the load (the machine will have four attempts to balance the load) the machine will not spin until the load has been redistributed.

This can happen should you attempt to spin a very small load (one or two items) or one very heavy item – ie a jumper.

On the rare occasion when this does occur, redistribute the laundry within the drum and may be add an extra item, ie a towel to help balance the load and enable the machine to spin safely.

Do not attempt to wash, rinse or spin any garment bearing the  label in this machine.

Programme selection			Programme Cycle
① Programme Selector	② Temperature Selector	Buttons	
4	—		Rinsing – Spinning at 1100 rpm
4	—		Rinsing with rinse hold *)
5	—		Spinning – for laundry washed by hand
5	—	 + 	Pump out – short spin 800 rpm
5	—	 + 	For laundry washed by hand
6	—		Pump out e.g. following a programme with rinse hold

The spin time on Programme 5 can be reduced at any time by pressing the programme selector knob 1 in, to switch the appliance off.

Drying

Important

The dryer operates on the condensation principle and the inlet water stopcock must be turned on during drying.

The drying cycle on your machine operates by electronic sensors within the drum, constantly sensing the dryness of the laundry throughout the drying cycle.

Preparation for drying

All laundry to be tumble dried must have been previously spun. Take note of the advice given on Care labels and programme charts about spinning.

We would recommend sorting of laundry so that each drying load is of similar fabrics (see Care labels).

Important

At the end of the wash cycle, take the laundry out of the drum and redistribute loosely in the drum before selecting to tumble dry. This ensures an even drying result avoiding any possibility of heat damage to the laundry.

What not to put in the dryer



Delicate fabrics – e. g. curtains of synthetic fibres, woollens, silks, fabrics with metal additives, ladies' tights, bedspreads, quilts and other voluminous fabrics, and articles which consist mainly of foam rubber or rubber-like material – must not be dried in the tumble dryer.

Do not tumble dry articles which do not carry a label indicating that tumble drying is recommended.

Warning:

Do not dry articles which have been cleaned in inflammable dry cleaning solutions (benzine, alcohol, spot remover, etc) – there is a risk of fire if such articles are dried in the tumble dryer. Dry only articles which have been washed in water.

Care symbols – drying

Symbol	Material
	Acrylics Easy-Care
	Cotton Linen
	Not suitable for machine drying

Advice on loads:
Cotton – max. 2.5 kg
Washing loads of 5.0 kg must be halved!

Easy-Cares – max. 1.5 kg. That is, the normal washing load can be dried.

Untangle the washing by hand.

Acrylics drying programme:
 If articles of acrylic material are to be dried after washing, they have to be spun dry at 1100 rpm or more (Programme ⑤).

Table of programmes – drying

Programme	Articles	Load
1 Acrylics	100 % acrylic fabric	up to 1.5 kg
2 Easy-Cares	Bed- & table linen, shirts & blouses of synthetics and cotton-synthetic mixtures	1.0 – 1.5 kg
3 Cottons, iron ready	Bed- & table linen	2.5 kg
4 Cottons, cupboard ready	Bed linen, kitchen towels, towelling	2.5 kg

To help you calculate your load a little more easily:

Washing weights

Article:	Approx. weight g
Quilt cover	700–1000
Bed sheet	500–700
Blouse	100
Terrycloth towel	150–200
Tea towel	100
Shirt	200
T-shirt	100
Underpants, short	50
Pillow case	200
Napkin	50–100
Handkerchief	20

The weights are for articles of cotton.

Facia symbols

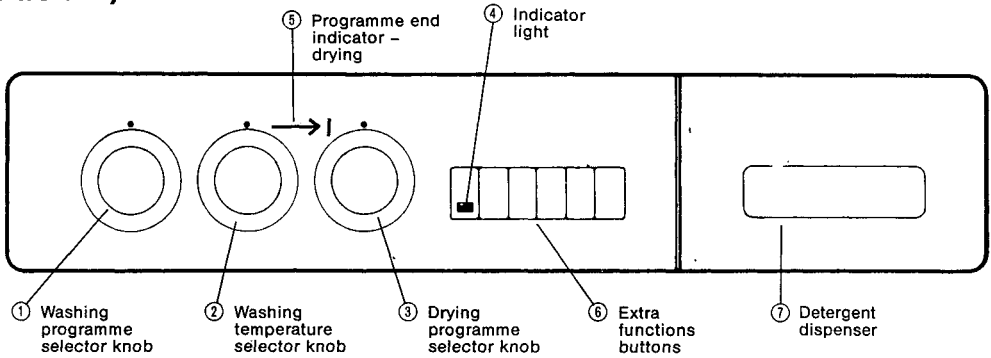

Programme selection - drying

Before selecting a drying programme, turn the washing programme selector knob ① to the "off" position, then pull the knob out. You can then choose from 4 different drying programmes:

- 1 Acrylics
- 2 Easy-Cares
- 3 Cottons & linens, iron ready
- 4 Cottons & linens, cupboard ready

The Drying Programme Selector knob ③ must be pulled out to start the programme.

Drying time depends upon the amount of washing, size of articles, wetness, types of material, and the chosen drying programme.

Do not interrupt drying

To protect the washing, the drying programme must not be interrupted, or switched off, until it is finished. There is also a risk of burning the fingers or hands on the hot washing or drum if you do not wait until the drying process is completed.

Programme end / switching off

The end of a programme is indicated by a distinctive, intermittent audible signal, over a period of approx. 1 minute, and by the blinking indicator → ④. The washing can then be removed from the appliance. If the washing is not removed at this time, the appliance will continue with its drum reversing action for approx. another 30 minutes, to avoid the washing becoming tangled up. During this period, the light blinks to remind you that the drying programme is completed.

After every drying programme, the Drying Programme selector knob ③ must be turned to the "●" position.

The appliance is switched off by pressing in the washing programme selector knob ①.

If washing and drying are finished, turn off the water inlet stopcock.

After drying

If washing is still too wet when a drying programme has finished, load it back into the appliance, close the door and set a new drying programme. Remember that the washing programme knob must be pulled out, and the water inlet stopcock turned on, for the drying programme to operate.

Care and maintenance

Drain sieve (washing)/ lint filter (drying)

The drain sieve/lint filter is behind the flap at the lower left of the front of the appliance. Its function is to trap "foreign bodies" which may still be in the washing despite careful checking, and to collect "fluff" created from the drying cycle.

The sieve should be checked regularly and any particles in it washed out under a tap.

Removal of drain sieve and emergency draining

Open the flap over the sieve, by turning the lock at least a quarter of a turn anti-clockwise with a coin or screwdriver, then pressing on the left of the flap to cause it to swing open.

Draining:

Remove the stopper from the emergency draining hose and let any residual water run out into a basin (see Illustration ①).

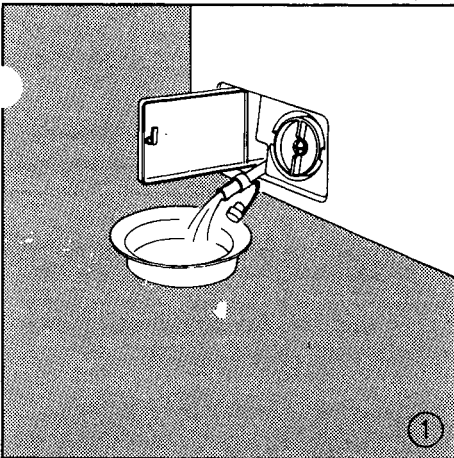

Put the stopper back into the emergency draining hose.

Turn the cap of the sieve anticlockwise to loosen the sieve.

Pull the cap and sieve out of the housing and wash them under a tap to remove any particles (see Illustration ②).

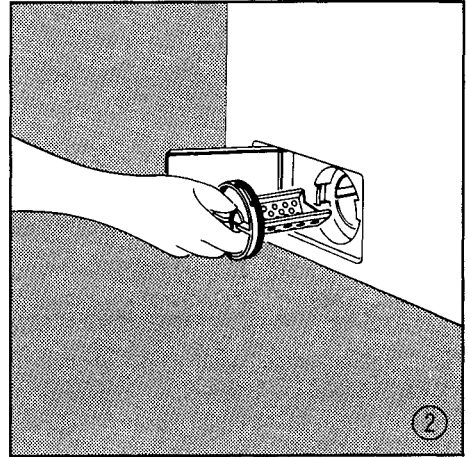

Refit the sieve and cap in the reverse order. Make sure that the cap is tight, to stop water leaking out during washing.

For safety, ensure that the flap over the sieve is closed, and turn the lock clockwise until it reaches a stop.

Warning:

Before draining in an emergency, allow the water or suds in the drum to cool down, then drain water out from the emergency draining hose until the level is below the bottom of the door window. This ensures that no water will run out of the door when it is opened. The appliance has to be switched off before the door can be opened.

Motor overload protection

The motor is equipped with a thermal overload device which switches off the power to the motor if the latter gets hot. The device automatically switches the motor on again after approx. 30 minutes.

Care

Your washer dryer requires no special attention. However, the following points should be checked periodically.

Detergent Dispenser

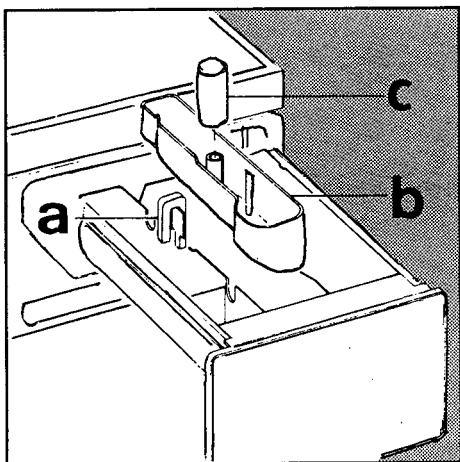

This can be removed for thorough cleaning – pull out to natural stop position, then give a short, sharp tug to remove it.

Residues of detergent can be washed off under a tap, using a brush if necessary.

Pull syphon (a) out upwards. If one is fitted, remove the liquid wash container (b), and the suction bell (c), and clean them both.

After the residue of detergent has been washed out of the dispenser with (preferably) warm water, refit the liquid wash container and suction bell. When re-fitting the syphon (a), the longer leg must be pushed into the middle compartment.

Control panel

This should be wiped with a moist cloth and washing up liquid (do not use abrasive cleaners, or furniture polish). Wipe dry afterwards.

Casing

The casing is painted and can be cleaned with a moist cloth and washing up liquid, or a mild cleaner (no abrasive cleaners). Wipe dry afterwards.

Door seal

Wipe this over occasionally with a moist cloth, to remove any residue of detergent and lint.

Drum

The drum of your machine is made of stainless steel and cannot rust. However, rust may be introduced with the laundry by such items such as paperclips, hair pins, safety pins, zips. Remove such stains with a stainless steel cleaner. After cleaning do not close the door, but allow air to get into the drum to dry it and to ventilate the appliance.

Protecting the machine against frost

Any damage due to frost is not covered by warranty.

If your Lavamat is installed in an unheated outhouse or laundry room, it is advisable to empty the machine of water should there be any possibility of frost (see removal of drain sieve).

The inlet hose should be unscrewed from the stopcock and drained completely. If the drain hose is looped, it must also be drained.

If you think your machine is not working properly

Malfunctioning of your washer/dryer is mostly due to minor causes – before you call out a service engineer please check through the fault finding chart below.

Hints for dealing with minor operating problems

There is no electrical operation following switching on.

Is the plug properly in its socket?
Has the fuse blown or a circuitbreaker tripped in the house circuit?
Is the loading door properly closed?

Little or no water comes in after the programme has been started.

Is the inlet water stopcock turned fully on?
Does the sieve in the water inlet valve need cleaning?

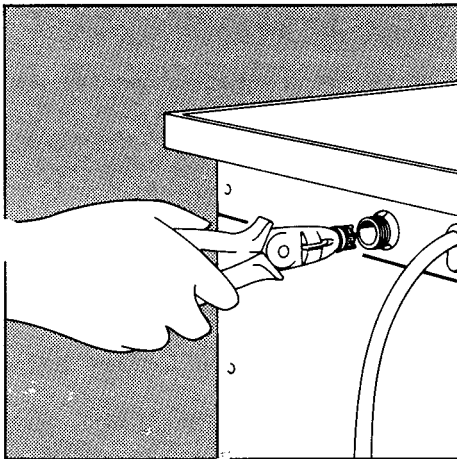

This sieve protects the water inlet valve from dirt particles. If washing powder is not properly flushed in, it is possible that this sieve is blocked (causing reduced water pressure). Turn the **inlet**

stopcock off and unscrew the ribbed plastic ring on the inlet hose (at the appliance) carefully with pliers then remove the hose from the stub.

Grip the sieve on its flange with pliers and pull it out of the stub. Hold the sieve with the flange downwards under a running tap and wash any dirt off it.

Carefully remove any particles which remain with a needle from the mesh. Push the sieve back into the stub until it hits a stop – the flange should be outside. Secure the inlet hose ring to the stub. Turn the stopcock fully on – if water leaks from the connection, tighten the plastic ring carefully with pliers.

Suds are not drained or are only partly drained.

Is there a kink in the drainage hose?
Does the drain sieve need cleaning?

Washing powder is not fully flushed in.
Is the powder dry and free of lumps?

Fabric conditioner does not disappear.

Check the position of the syphon (U-piece). Clean the syphon and the compartment if necessary (see **Care – detergent dispenser**).

Power fails during washing if the water level is above the bottom of the window:

Let suds cool to a safe temperature and then drain appliance through the emergency draining hose (see **Removal of drain sieve and emergency draining**).

Vibration during spinning.

Is the drain hose kinked?
Is the drain sieve blocked?
Transit bars have not been removed?
If there is too little laundry in the drum, e. g. bath mat, may lead to vibration, therefore wash more items.
Is the appliance set up properly? (See **Setting up**).

Foam or water runs out under the appliance.

Have you used too much detergent?
Check that the clamping rings on the inlet and drainage hoses are tight.
Is the inlet hose itself leaking?
Is the drain sieve properly in place?
(See Removal of drain sieve and emergency draining).

Washing is too wet after spinning.

If only a single article has been spun, it may be that poor distribution of the load has caused the electronic out of balance control, to stop the spin. In this case, leave the wet article(s) in the drum, add a few more articles to them, and spin again.

Non-stop water inlet and simultaneous drainage.

Then there is a so-called "syphon effect", with the waste water sucking suds out of the drum. Switch the appliance off, then lift the drain hose as high as possible for a few seconds, so that water drains from it back into the appliance. Check that the hose end does not lie under water, put the hose back into position and restart the appliance.

The loading door cannot be opened.

Turn the washing programme selector knob to "●".
Wait approximately 90 seconds for the door lock to open, then try opening the door again.

The first use of the dryer.

Grease evaporates from the heating element and the outer drum when the dryer is first switched on; this can cause a smell, which will disappear after a short time.

If the intermittent audible signal carries on for more than a minute after the drying programme has ended.

Was the drying load too big?
Was the appropriate drying programme selected?
Was the wash spun sufficiently dry?

Was the inlet stopcock open?
Is the sieve in the inlet valve blocked with dirt?
Is the drain sieve/lint filter blocked?

If you call a service engineer in connection with one of the afore mentioned problems, please note that the cost involved for this call will have to be passed on to you even during the warranty period.

Breakdown – what to do

Good quality and modern construction techniques ensure fault-free functioning of the appliance. If, however, a fault should occur, please check first whether all hints and advice contained in these User Instructions have been followed. Possibly only a minor fault is the reason for the breakdown.

Should you be unable to locate the cause of the problem in spite of the check list "If you think your machine is not working properly", then please contact your AEG Service Department.

If you require to have your machine serviced you will assist the Service Department by quoting the F and E numbers which you will find on the rating plate (see access flap to drain filter).

For easy reference we would recommend that you transfer these numbers in the space provided below:

Product number (E-No.)

Serial number (F-No.)

To maintain the safety of your appliance, you should only have repairs, especially on live parts, performed by a trained electrician. In the event of a fault, you should therefore approach your retailer or the AEG After-Sales Service direct.

AEG Domestic Appliances Ltd

Customer Care Department

55-77 High Street

Slough

Berkshire SL1 1DZ

Telephone: 08705 350350

AEG Hausgeräte AG

Postfach 1036

D-90327 Nürnberg 1

© Copyright by AEG

GA 6603/06.90 TNR 302 231