

MICROMAT 1231 E





Microwave oven

Operating Instructions

Dear customer,

Thank you for buying an AEG microwave oven.

Before using your AEG microwave with grill for the first time, please read the instruction book thoroughly. This will enable you to take advantage of all the features that the appliance offers. It will also ensure trouble-free operation and prevent unnecessary service calls.

-  Important information concerning your safety or the operation of your appliance is noted by this symbol and/or mentions such as "Warning", "Take care". Be sure to follow all instructions carefully.
-  Throughout the manual, this symbol assists you in the proper use of your appliance.
-  This symbol indicates further information concerning the use of the appliance.
-  The clover indicates energy-saving tips and and hints for environmentally friendly use of your appliance.

If you require further assistance or advice, please contact our customer Care Department either by letter or telephone.

Contents

Important information	
Ecologically responsible disposal of packaging and old appliances	4
Safety Instructions	
General	5
For trouble free and safe operation	5
Microwaves	6
General operating instructions	
Suitable ovenware	8
What else to note..	9
Installing and Connecting	9
Electrical connection	10
Product Description	
The appliance	12
The Control panel	13
Accessories	14
Special accessories	14
Before using the appliance	
Setting the clock	15
"At a glance" operating instructions	16
Modes of operation	
Microwaves	18
Notes on power levels	19
Automatic programmes	20
Quick-Start	23
Minute Timer with alarm	24
Cooking charts and Tips	
Microwave tables	25
Practical tips for use	29
Tips on microwaving	30
Test procedures	31
Cleaning and Care	32
What to do if...	33
AEG Service and Spare Parts	34
Guarantee Conditions	35

Important information

Ecologically responsible disposal of packaging materials and old appliances

Packaging materials

AEG microwave ovens require effective packaging to protect them during transportation. Only the minimum packaging necessary is used.



Packaging materials (e.g. foil or styrofoam) can place children at risk. **Danger of suffocation. Keep packaging material away from children.**



All packaging materials used are environment friendly and recyclable. The cardboard is made from recycled paper and the wooden parts are untreated. Plastic items are marked as follows :

«PE» polyethylene eg packaging film

«PS» polystyrene eg packaging (CFC-free)

«PP» polypropylene eg packaging straps

By using and re-using the packaging, raw materials are saved and waste volume is reduced.

Packaging should be taken to your nearest recycling centre. Contact your local council for information.

Disposal of old appliances



Old appliances should be made unusable before disposal by removing the plug, and cutting off and disposing of the power cable. It should then be taken to the nearest recycling centre, or authorised disposal site.

Safety instructions



General

- The appliance should only be operated with the turntable and turntable support inserted.
- Only suitable microwave ovenware should be used.
- To protect the appliance against corrosion from moisture (condensation) in the cavity or on the door, wipe these areas dry after each use.
- Do not leave the appliance unattended when warming or cooking food in disposable containers made of plastic, paper, or other flammable materials.
- If smoke is observed, keep the oven door closed and disconnect the power supply. Never use the microwave oven if it is no longer functioning properly.
- This appliance complies with all relevant safety instructions. In order to maintain the safety of the appliance, repairs should only be carried out by a fully qualified electrician, trained by the manufacturer. Repairs carried out by unqualified electricians can place the user in severe danger. In the case of any defect or breakdown, please contact your local AEG Service Force Centre.
- Should the door seals and/or door seal surfaces be damaged, the appliance should not be operated until it has been repaired by AEG Service Force.
- Damaged appliance parts can only be replaced by exactly the same make of parts. Special tools are required for this operation.
- WARNING** : Do not allow children to use the microwave oven without supervision unless they have been thoroughly instructed in the proper use and the dangers of improper operation



For trouble free and safe operation

- Never jam anything between the door and the door frame.
- Always keep the door seals and their surfaces clean.
- Do not keep any flammable items in the microwave. They could ignite when the unit is switched on.
- Switch the appliance on only when food has been placed inside the cooking space, as it could overload if there is no food present.

Microwaves



- Whenever heating liquid, please also place a teaspoon in the container to avoid delayed boiling. During delayed boiling, the boiling temperature is attained without the typical steam bubbles rising. When the container is shaken, even slightly, the liquid may then suddenly vigorously boil over or spurt - with the risk of scalding the user.

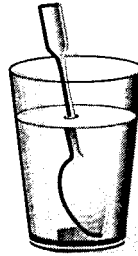

- Food with "skin" or "peel", such as potatoes, tomatoes, sausages, and the like, should be pierced with a fork so that any steam present can escape and the food will not burst.

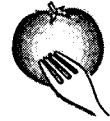

- Make sure that a minimum temperature of 70°C is attained for the cooking/heating of food. Never use a mercury or liquid thermometer for measuring the temperature of the food.

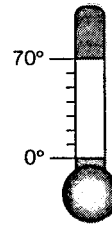

min. 70 °C

- Baby food in jars or bottles should always be heated without a lid or top, and well stirred or shaken after heating, to ensure uniform distribution of the heat. Always check the temperature before feeding to your child.
- The hot food in a microwave oven will heat up the ovenware. Always use oven gloves for handling hot dishes.
- Never cook your food for too long or at too high a power setting. Some areas of the food can dry out or even ignite.



Do not use your microwave oven for the following :

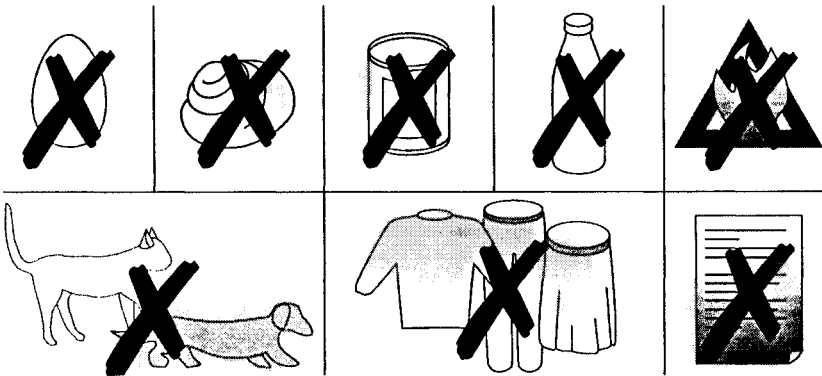

- to boil eggs or escargots in their shells, as they will burst. Eggs can be poached or "fried" in a microwave oven as long as the yolks are pricked.
- to heat large quantities of cooking oil (fondue or deep frying) and drinks containing a high percentage of alcohol - there is danger of spontaneous combustion!
- to heat unopened cans, bottles, etc.
- to dry animals, textiles or paper.
- for crockery like porcelain, ceramics, or porous earthenware (e.g. on the handles or unglazed bases) that can fill up with water. This can cause vapour pressure to build up during cooking which could shatter the dish.

i General operating instructions

Suitable ovenware

Ovenware material	Mode of operation		
	Defrosting	Heating	Cooking
Ovenproof glass and ceramic dishes (without any metal parts, e.g. Pyrex, Oven-to-tableware)	X	X	X
Non ovenproof glass and porcelain (e.g. table crockery) ¹⁾	X	-	-
Glass ceramic and vitro-ceramic made of fire/frost proof material (e.g. Arcoflam)	X	X	X
Ovenproof earthenware ²⁾	X	X	X
Plastic, heat-resistant up to 200°C ³⁾	X	X	X
Paper, cardboard	X	-	-
Cling film	X	-	-
Microwave cling film ³⁾	X	-	X
Black-lacquered or silicone-coated baking tins	-	-	-

X suitable - unsuitable

1) excluding silver, gold, platinum or metal decoration

2) does not include glaze containing metal

3) please respect the maximum temperature stated by the manufacturer



What else to note...

- Food comes in all shapes, sizes and textures. The quantities also vary. For these reasons the time and amount of energy needed to defrost, heat or cook will also vary. As a general rule :

Double the quantity = nearly double the time

Please refer to the cooking charts. To be on the safe side, always select the shorter cooking time. Then extend the time as necessary.

- Microwaves work by making the food heat itself up. Because of this, not all areas of the food will be heated at the same time. When heating larger quantities of food, it is particularly important to stir or turn them over.
- "Standing time" is referred to in the cooking charts. This is the time you should leave the food to stand without power (either inside or outside the appliance). This ensures even distribution of heat throughout the food.

Installing and Connecting

This oven can be used as a free standing oven or built-in into a kitchen cabinet using the kit supplied with the appliance. To install the oven in a kitchen cabinet follow the instructions supplied.

The oven should be installed on a flat, level surface. The surface must be strong enough to safely bear the weight of the oven and the contents.

If used as a free-standing appliance, make sure that air circulates freely around the oven.

Leave sufficient space round the oven :

- 5 cm between the sides of the oven and any objects
- 5 cm behind the oven
- 10 cm above the oven

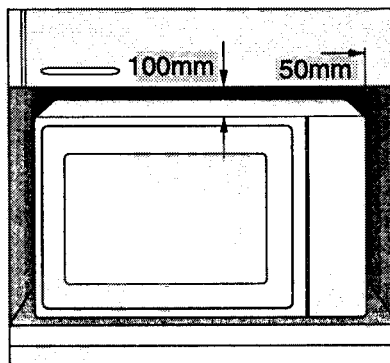

Electrical Connection

Any electrical work required to install this appliance should be carried out by a qualified electrician or competent person.

WARNING - THIS APPLIANCE MUST BE EARTHED.

The manufacturer declines any liability should these safety measures not be observed.

Before switching on, make sure the electricity supply voltage is the same as that indicated on the appliance rating plate. The rating plate is located at the back of the appliance.

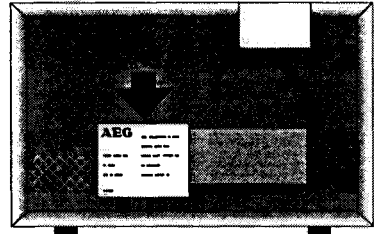



The appliance is supplied with a 13amp ASTA approved (BS1362) fuse must be used.

Should the plug need to be replaced for any reason.

The wires in the mains lead are coloured in accordance with the following code :

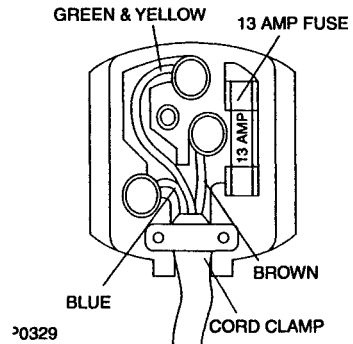
Green and Yellow:	Earth
Blue:	Neutral
Brown:	Live



The wire coloured green and yellow must be connected to the terminal marked with the letter "E" or by the earth symbol  or coloured green and yellow.

The wire coloured blue must be connected to the terminal marked "L" or coloured brown.

Upon completion there must be no cut, or stray strand of wire present and the cord clamp must be secure over the outer sheath.

WARNING: A cut off plug inserted into a 13 amp socket is a serious safety (shock) hazard. Ensure that the cut off plug is disposed of safely.

Permanent connection

In the case of permanent connection it is necessary that you install a double pole switch between the appliance and the electricity supply (mains), with a minimum gap of 3 mm between the switch contacts and of a type suitable for the required load in compliance with the current electrical regulations.

The switch must not break the yellow and green earth cable at any point.

CE This appliance complies with the following EC Directives :
73/23/EEC of 10.02.1973 - Low voltage directive 89/336/EEC
of 03.05.1989 (incl. Amendment Directive 92/31/EEC) - EMC
(Electromagnetic Compatibility) Directive.

Product Description

The appliance

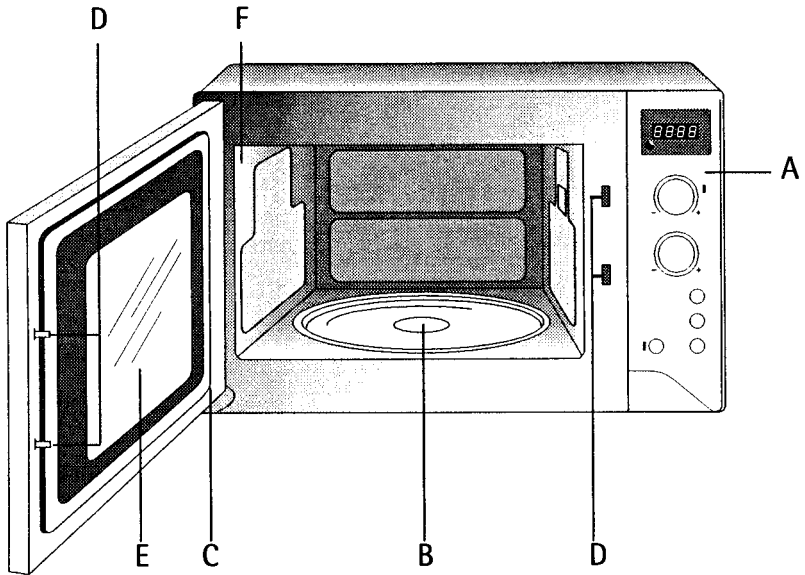



- A** Control panel
- B** Turntable
- C** Door seal
- D** Door latch and catch
- E** Viewing window
- F** Interior lighting

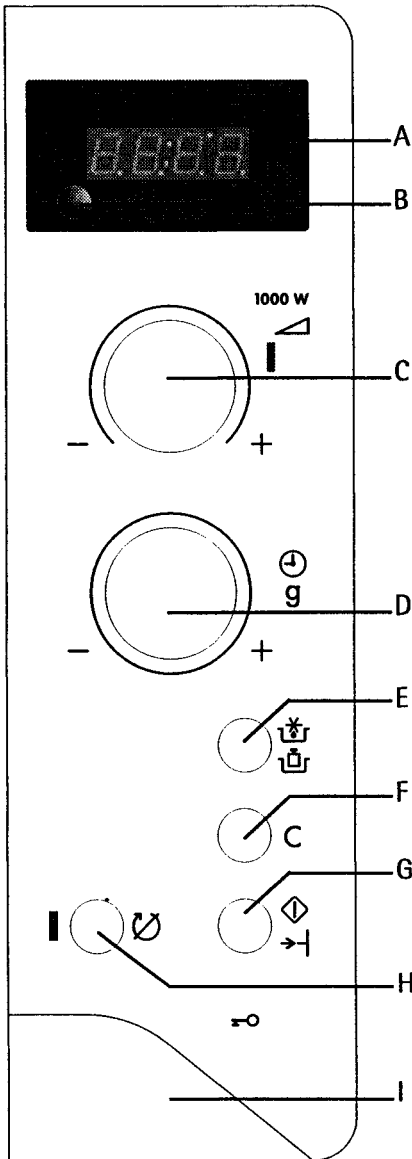

The control panel





A Display for time of day, cooking time, function mode, power etc.

B Multi-function button  to display the selected microwave power, defrosting and cooking times, etc.

C Power knob  with signal light to select microwave power.

D Rotary knob to select the cooking time  or the weight  when using automatic programmes.

E Button for automatic programmes   for defrosting and cooking.

F CLEAR button  to cancel settings or interrupt a programme underway.

G START button  to start the selected function and to switch on QUICK-START.

H Button for switching the turntable off with signal light.

I Button for opening door .

Accessories

The turntable and turntable support should be installed as shown in the diagram.

Take care to ensure the turntable support is properly in place.

The turntable may turn clockwise or counterclockwise during operation.

Do not try to rotate the roller ring manually, as you could damage the drive system.

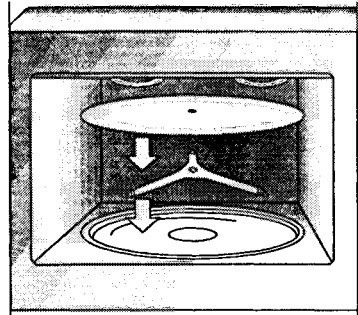

Special accessories

May be ordered either through your retailer or AEG Service Center.

Rack

(E-Nr. 661 917 375)

Make sure to place the browning dish on the rack to avoid damaging the turntable.

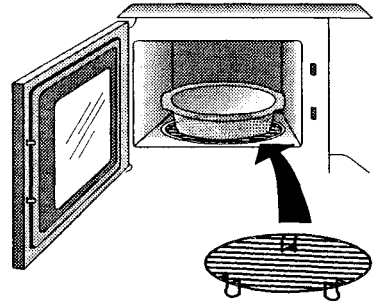

Before using the appliance

Setting the clock

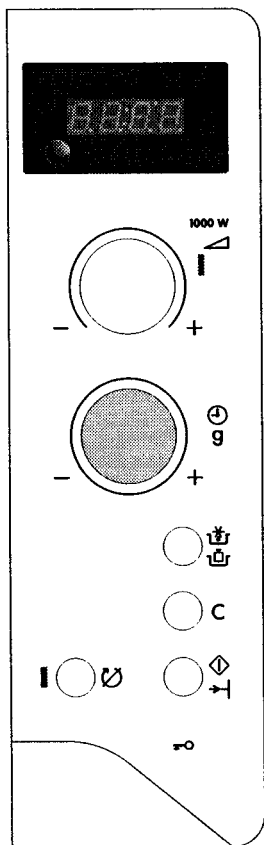

Example: 12:15 hrs

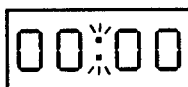

1. Plug the appliance into the mains. The display starts to flash "00:00" and then "REG". The dots between the digits blink rapidly.





2. Press the multi-function button  SET beneath the display (top left side). The dots between the digits blink faster.

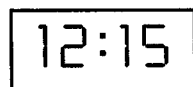

3. While keeping the multi-function button  SET pressed, set the time of day with the rotary knob ¹⁾. Release the button as soon as the time of day is displayed. The dots between the digits blink slowly. The appliance is now ready for use.



¹⁾ The rotary button  can be turned clockwise (to increase) or counterclockwise (to decrease).

The time of day can be corrected at any moment by pressing the multi-function button  SET and simultaneously turning the rotary button .

"At a glance" operating instructions

Action	Comments
1. Press door open button  .	The door opens.
2. Place food in the cooking space.	
3. Shut the door.	The door will click audibly when it is properly shut. If the door is not shut properly, the appliance will not function.
4. Select according to the instructions given on the following pages.	The order in which you programme functions has no consequence ¹⁾ . Turn the time button clockwise to increase or counterclockwise to decrease time ²⁾
5. If required : switch off the turntable.	When the turntable has been switched off, the appropriate signal lamp lights up. The turntable should only be turned off when using rectangular ovenware that is larger than the turntable and is in danger of jamming.
6. Press the START-button  .	The appliance starts. The display shows the selected cooking time, counting down backwards in seconds. (The signal light representing the chosen function lights up.)
7. End of cooking sequence.	The end of the cooking sequence is indicated by a triple audible tone. The appliance and the interior light will switch off. The display area once again shows the time of day.



- ¹⁾ If the oven is not started within 4 minutes, the settings are automatically cancelled ; time of day reappears in the display.
- ²⁾ If the maximum cooking time setting « 60:00 » is surpassed during the setting, the display shows « 00:00 »



Action :	Comments
<ul style="list-style-type: none">• Open the door by pressing the door → e.g. for stirring.	The appliance and interior lighting switch off. In the display, the two dots between the digits flash. The selected settings remain. The remaining time counts down automatically.
<ul style="list-style-type: none">• Shut the door and press the START button 	
<ul style="list-style-type: none">• Press the CLEAR button .	The running process is cancelled. The appliance and the interior lighting switch off. Time of day is displayed.
<ul style="list-style-type: none">• Modify the selected cooking time: turn the rotary knob clockwise or counterclockwise.	The cooking time in the display changes when turning the rotary button. ¹⁾
<ul style="list-style-type: none">• Modify the selected microwave power: rotate the power knob 	The new power setting is displayed for 5 seconds. The cooking process continues with the new power setting.
<ul style="list-style-type: none">• Press multi-function button SET.	The selected parameters are displayed successively for 5 seconds each, e.g. programme name, weight, microwave power ...



¹⁾If the new selection reaches « 00:00 » in the display, the cooking time is over and an audible signal sounds three times. The appliance and the interior lighting switch off. During a cooking process, the cooking time can be increased to a maximum of 60 minutes.

Modes of operation

Microwaves

Setting

Example: 1 minute 15 seconds on microwave output level 850 Watt

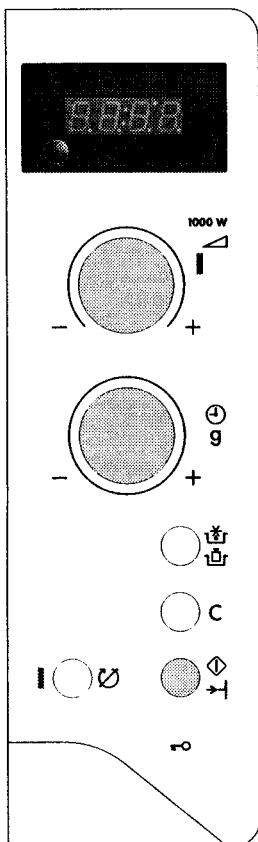

1. Set the required microwave power by turning the power knob. The signal lamp lights up. The time of day disappears from the display and the required microwave power appears: turn to the left = lower power
turn to the right = higher power

2. Set the required cooking time by turning the Rotary knob . The chosen time appears in the display.

3. Press the START button . The selected time starts to count down.



Cooking times can be set as follows :

- from 0 to 2 min. in 5 second steps
- from 2 to 5 min. in 10 second steps
- from 5 to 10 min. in 20 second steps
- from 10 to 20 min. in 30 second steps
- starting from 21 min. in 1-min. steps

Maximum programme length is 60 minutes.

Metal items must be kept at least 2 cm from the cavity wall and the oven door.



Notes on microwave power levels









The following list shows you the power settings and what they can be used for during microwave operation :

1000 Watt	<ul style="list-style-type: none">- heating liquids
850 Watt 700 Watt	<ul style="list-style-type: none">- to start a cooking sequence, start roasting,- stewing, etc.- cooking vegetables- cooking dishes
600 Watt 500 Watt	<ul style="list-style-type: none">- defrosting and heating of deep frozen ready made meals- heating refrigerated ready made meals- finish cooking casseroles- cooking egg based dishes
450 Watt 350 Watt 250 Watt	<ul style="list-style-type: none">- finish cooking dishes- cooking of delicate dishes- heating baby food in glass jars- soaking rice- heating delicate dishes- melting of gelatin
150 Watt 80 Watt	<ul style="list-style-type: none">- defrosting meat, fish and bread- defrosting cheese, cream and butter- defrosting cakes with cream or butter icing- to let dough rise- warming cold dishes, drinks, softening butter

Automatic Programmes

Programmes for defrosting and cooking are available. After having selected the programme, merely enter the weight of the dish, the rest of the programming is done automatically. The following gives you an overview of which food can be defrosted and/or cooked with which programme.

Automatic defrost

Programme	Food categories	Examples	Weight from - to
 	Poultry fresh ¹⁾	Poultry (whole or portions)	100 - 2000 g
 	Meat	Pork roast, goulash	100 - 2000 g
 	Fish	Fish (whole or fillets)	100 - 1000 g
 	Delicate cakes and pastries	Cream pie	100 - 750 g

¹⁾ Cover legs and wings with aluminium foil before defrosting.





Unpack your frozen food item, place atop a small overturned dish set inside a larger one to catch the liquid from defrosting.

Be sure and follow our recommended standing time (general rule : standing time = defrosting time).

A triple bell will ring halfway through defrost time. Turn or mix dish and, if possible, break up into pieces.

Automatic cooking programmes

Programme	Food categories	Examples	Weight from - to
	Fresh vegetables I	Brussels sprouts, cabbage, carrots, celeriac	100 - 1000 g
	Fresh vegetables II	Zucchini, leeks, potatoes, spinach, fennel, cauliflower, broccoli	100 - 1000 g
	Frozen vegetables	Carrots, cauliflower, Brussels sprouts, leeks, zucchini, spinach, broccoli	100 - 1000 g



Cook covered, in a heat-resistant glass dish, whenever possible. A triple bell rings halfway through cooktime. If cooking over 500 g of vegetables, stir once or twice.

Please add water in the following amounts :

- for fresh vegetables (I+II):

100 - 500 g : 3 - 6 tablespoons / 500 - 1000 g : 9 - 12 tablespoons.



- for frozen vegetables :

100 - 500 g : 3 - 9 tablespoons / 500 - 1000 g : 9 - 15 tablespoons.

How to use automatic programmes

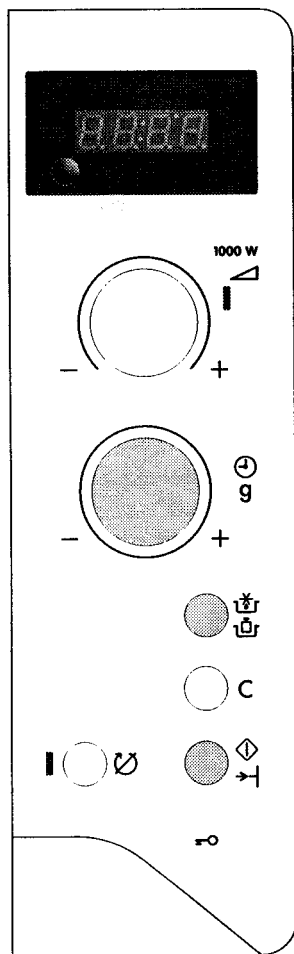
 Example : defrosting 1 kg chicken



1. Press the button for automatic programmes   until the desired programme appears in the display.

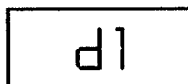

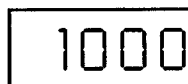

2. Use the Rotary knob to set the weight 

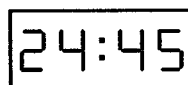

3. Press the START button . The display shows the necessary time.





4. If you want to modify the settings, you have to press the Clear-button  and start again.

 Midway through the programme, three short bells will be heard. Stir or turn the food item at this time. The oven does not switch off.

QUICK-Start



How to set

The Quick-Start button  provides full microwave power for from 30 seconds up to 2 minutes and 30 seconds, by 30 second-intervals. Each time you push the Quick-START button , the programme time is increased by 30 seconds.

Example : heating a cup of water (1 min. 30 sec.)

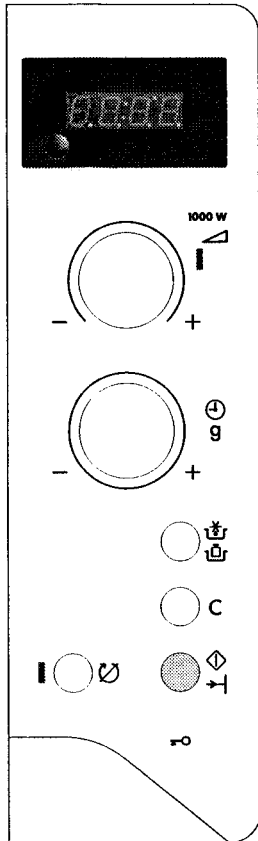

1. Press the START-button  three times. The time appears in the display and the programme begins. The microwave power signal lamp lights up.

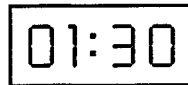

2. You may increase the time by 30 second-intervals while the programme is running up to a limit of 2 minutes and 30 seconds by pressing the START button .





You cannot use Quick-START for programmes exceeding 2 minutes. Use the Quick-Start solely for the heating of liquids.

Minute timer with alarm

The minute timer with alarm can also be used as a general purpose reminder. For example, you could use it to set the time it takes to boil the egg that you are cooking on the hob. The timer works without switching on the appliance, as long as no other functions have been selected.



How to set:

1. Select microwave power «0» using the Power knob  (all the way to the left).
2. Set the required time with the Rotary knob . The time of day disappears from the display and the required length of time appears.
3. Press the START- button . The pre-set time will start to count down. An audible triple signal will sound when the timer has finished counting down.

Cooking charts and tips

Defrosting

Dish	Weight in (g)	Power (Watt)	Duration (min)	Standing time (min)	Remarks/Hints
Meat					
Whole meat	500	150	12-20	10-20	Turn once. Cover fatty parts with aluminium foil after 1st half of defrosting time.
Steak	200	150	5-7	5-10	Turn once.
Mixed chopped meat	500	150	12-20	10-20	Remove defrosted chopped meat after half the time.
Goulash	500	150	12-20	10-20	Remove defrosted meat after half the time.
Poultry					
Chicken	1000	150	22-30	20-30	Turn once. Cover legs and wings with aluminium foil halfway through defrosting time.
Duck	1500-2000	150	30-50	40-60	As for chicken.
Fish					
Whole fish	500	150	13-15	15-20	Turn once. Cover fins with aluminium foil.
Shrimps/crab	250	150	7-9	15-20	Stir thoroughly.
Dairy produce					
Cottage cheese	500	150	18-20	15-20	Divide and stir frozen pieces from time to time.
Butter	250	150	2-4	15-20	Remove any aluminium foil wrapping.
Cheese	250	150	3-5		Turn once.
Cream	200 ml	150	7-10	15-20	As for butter. Stir from time to time.
Fruit					
Strawberries	500	80	10-14	5-10	Defrost in covered container, turn once.
Cherries	250	80	5-7	5-10	As for strawberries.
Black currants	250	80	5-7	5-10	As for strawberries.
Red currants	250	80	9-12	5-10	As for strawberries.

Defrosting

Description	Weight in (g)	Power (Watt)	Duration (min)	Standing time (min)	Remarks/Hints
Bread					
Rolls (50g)	4 units	150	2-4	3-5	Set on a paper towel, turn once.
Wholemeal, mixed, rye loaf	1 slice (60-80g) 500	150 150	1-2 8-12	3-5 10-15	Defrost in a covered container. Cover cutting surface.
Pastry					
Dry cakes eg cakes with short crust pastry	300	80	5-8	30-40	Set on a paper towel, cover.
Fruit flans baked on a baking sheet	400-450	80	8-12	7-10	As for dry cakes.
1 slice cheese cake	400	80	8-12	7-10	As for dry cakes.
1 slice covered apple tart	400	80	6-12	7-10	As for dry cakes.
Cream and butter-cake	300-400	80 400	5-8	10-20	Begin defrosting with micro waves, then remove.
Melting of food					
Chocolate/toppings	100	700	1-3		Break up into pieces, stir from time to time.
Butter	50	850	1 1/2-1		To warm set time for 30 sec. longer.
Heating of refrigerated food and drink					
1 jar baby food	125-250	450	1/2-2	2-3	Heat jar without lid. Stir after warming. Check temperature.
1 ready meal on a plate	350-400	850 400	3-5	2-3	Heat in a covered container. Place gravy alongside in a cup.
1 portion meat	ca.150	850	1-2	2-3	All meat, except breaded meat, should be heated in a covered container.

Description	Weight in (g)	Power (Watt)	Duration (min)	Standing time (min)	Remarks/Hints
1 portion vegetables, potatoes or rice	ca. 200	850	1-2	2-3	Heat in covered container, stir once.
1 cup soup	ca. 200 ml	1000	1-2	2-3	Heat clear soup uncovered, cover thick soups. Stir.
Drinks					
Milk or baby food	200 ml	1000	1/2-1	2-3	Remove any lids. Stir after warming!
Boil 1 cup water	180 ml	1000	1/2-2	2-3	Stir instant coffee or tea when the water has stopped boiling.
1 cup milk	200 ml	1000	1	2-3	Heat milk till it is just hot enough to drink. Stir.
1 cup coffee (reheat)	200 ml	1000	1/2-1	2-3	Stir. Check the temperature!
Defrosting and heating of frozen convenience foods					
1 portion meat with gravy	150	850	3-5	2-3	Stir now and again. Heat in a covered container.
1 portion meat with vegetables, garnish	350-450	850	7-14	2-3	As for meat with gravy.

Cooking vegetables ¹⁾

Description	Weight in (g)	Liquid added	Power (Watt)	Duration (min)	Standing time (min)	Remarks/Hints
Cauliflower	500	1/8 l	850	6-8	2	Dot with butter.
Frozen broccoli	300	1/8 l	850	5-7	2	Stalks facing outwards.
Mushrooms	250	none	850	3-5	2	Cut into slices.
Frozen peas and carrots	300	1/2 cup	850	5-7	2	
Carrots	250	2-3 tsp	850	6-10	2	Cut into cubes or slices.
Potatoes	250	2-3 tsp	850	3-5	2	Peel and quarter.
Kohlrabi	250	1/2 cup	850	6-8	2	Cut into spikes or slices.
Red/green peppers	250	none	850	3-5	2	Cut into strips.
Leeks	250	1/2 cup	850	3-5	2	Cut into rings or pieces.
Frozen Brussels sprouts	300	1/2 cup	850	5-7	2	
Sauerkraut	250	1/2 cup	850	6-8	2	

¹⁾ Cook all vegetables in a covered container.

Cooking fish

Description	Weight in (g)	Power (Watt)	Duration (min)	Standing time (min)	Remarks/Hints
Fish fillets	500	600	7-9	3	Cook covered. Turn half-way through cooking time.
Whole fish	800	1. 850 2. 450	3-4 14-17	3	Cover during cooking. Turn half-way through cooking time.



The times stated here are for guidance only, and depend on the nature and type of food being cooked.

Cooking of meat and poultry

Description	Quantity (g)	Power (Watt)	Duration (min.)	Remarks/Hints
Pork				
Pork chop	3 pieces 370 g	1.750 2.600	6-8 12-14	Sear, then turn
Poultry				
Chicken	1000	750	12-14	Cook covered, add no liquid



Practical tips for use

General

- After switching off your appliance, let food stand inside for a few minutes to allow even heat distribution (**standing time**).
- Remove any aluminium foil or metal containing packaging before preparing the food.
- Metal objects must be placed at least 2 cm away from the cooking space walls and door. Otherwise arcing can occur, resulting in damage to the appliance.

Cooking

- Whenever possible cook covered. Only pastry dishes with crust should be cooked uncovered.
- Refrigerated or frozen food require longer cooking times.
- Foods containing sauces should be stirred from time to time.
- Cook soft vegetables such as carrots, peas and cauliflower with a little water.
- Cook soft vegetables such as mushrooms, peppers and tomatoes without liquid.
- Increase cooking time by approximately 50 % for larger pieces. Whenever possible, cut vegetables into equal-sized pieces.

Defrosting of meat, poultry and fish

- Place frozen, unpacked meat on an inverted plate in a glass or porcelain container, or use a sieve, so that the meat juice can drain.
- Halfway through defrosting, turn the food, dividing it where possible and removing the pieces that have defrosted.



Defrosting of butter, pieces of layer cake and cottage cheese

- Do not fully defrost in the appliance, but leave to adjust outside. This will give a more even result.
- Remove any metal or aluminium foil packaging and/or accessories before defrosting

Defrosting of fruit and vegetables

- Fruit and vegetables that are to be used raw later should not be fully defrosted in the appliance, but left to complete defrosting at room temperature outside.
- Fruit and vegetables that are to be cooked immediately afterwards can be cooked straight from frozen using a higher power level.

Ready made meals

- Ready made meals in metal packages or plastic containers with metal lids should be heated or defrosted in your microwave oven only if they are explicitly marked as being suitable for microwave use. Please follow the operating instructions printed on the packages (e.g. remove the metal lid and prick the plastic foil).



Tips on microwaving

You can't find cooking details for specific quantity of food.

Base programming on a similar-type of food. Lengthen or shorten the cooking time accordingly:

Double quantity = almost double time

Half quantity = half time

The food is too dry.

Set a shorter cooking time or reduce the microwave power output.

The food is not yet defrosted, heated through or cooked on completion of programme time.

Select a longer programme time or a higher microwave power setting. Note that larger food will require a longer time.

The food is overcooked on the outside and undercooked in the middle on completion of cooking time.

Next time, try a lower power setting for a longer time. Stir liquids, such as soup, periodically.

Test procedures

(Microwave output power 1000 Watt)

The quality and operation of microwave ovens are established by recognised test institutes by testing specific dishes.

DIN Nr. 44 566 Part 2	Power	Time (mins)	Standing time (mins)	Comments ¹⁾
Defrost and cook fish fillet	850 Watt	7-9	3	Cover. Halfway through cooking turn fillets so that inner edges face outwards.

IEC 705	Power	Time (mins)	Standing time (mins)	Comments
Egg custard (test A)	350 Watt	19-21	120	
Sponge mixture (test B)	850 Watt	5-7	5	
Meat loaf (test C)	850 watt	10 -12	5	
Defrost minced meat	150 Watt	12-14	5	Place directly on turntable. Turn halfway through.
Defrost raspberries	80 Watt	10-12	3	Cover.

¹⁾ Place directly on turntable unless otherwise instructed. The turntable has to be switched on.

i Cleaning and care

The Appliance Exterior

Wipe the front of the appliance using a soft cloth and a mild, warm detergent solution.

Do not use abrasive cleaning substances, strong detergents or coarse abrasive cleaning materials.

Cooking area

The interior will remain in good condition for a long time so long as you don't use scouring pads or rough abrasive materials. Use mild dish-washing liquid to clean the interior. You can neutralise odours inside the cooking area by boiling a cup of water with a little lemon juice for a few minutes in your oven.

Through normal operation, liquid may evaporate and condensation may occur. This is normal and is especially noticeable when the room temperature is high and the humidity of the air is low. After operation, be sure and wipe off the condensation with a soft cloth.

Turntable and Turntable support

The turntable can be removed by pressing down on the outer edge of one side so that the other side tilts up.

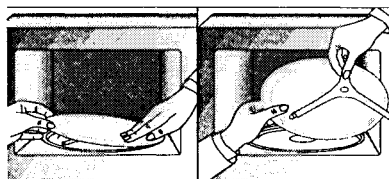



Clean the turntable using washing-up liquid, or put it in the dishwasher. Clean the turntable support with washing-up liquid.

This should be removed straight after each use and cleaned using washing-up liquid or in the dishwasher.

What to do if...

-  **...the microwave appliance is not working properly ?**
 - Check that
 - the fuses in the fuse cupboard are working,
 - there has not been a power cut.
 - If the fuses continue to blow, please contact a qualified electrician.

-  **...the microwave function is not working ?**
 - Check
 - the door is properly closed,
 - the door seals and their surfaces are clean,
 - the START-button  has been pressed.
 - the power knob is not set on '0'

-  **...the turntable is not turning ?**
 - Check that
 - the turntable support is correctly connected to the drive
 - the ovenware does not extend beyond the turntable,
 - food does not extend beyond the edge of the turntable preventing it from rotating
 - there is nothing in the well beneath the turntable
 - the turntable is switched on

-  **...the microwave will not switch off ?**
 - Isolate the appliance from the fuse box.
 - Contact the AEG Service Force Centre.

-  **...the interior light is not working ?**
 - Call the AEG Service Department. The interior light bulb can be exchanged only by trained AEG technicians.

-  **...the food is taking longer to heat through and cook than before ?**
 - Set a longer cooking time (double quantity = nearly double time) or
 - if the food is colder than usual, rotate or turn from time to time or
 - set a higher power setting.

AEG Service and Spare Parts

If after carrying out the necessary checks listed in the chapter "What to do if...", there is still a fault with your appliance please contact your local AEG Service Force Centre.

In guarantee customer should ensure that the suggested checks have been made as the engineer will make a charge if the fault is not a mechanical or electrical breakdown.

If you require a service engineer or wish to purchase spare parts contact your local Service Force Centre, by telephoning:

08705 92929

Your call will be automatically routed to the Service Centre covering your post code area.



Help us to help you

When contacting AEG Service Force, please determine your type of enquiry. When you contact us we need to know:

1. Your name, address and poste code.
 2. Your telephone number
 3. Date of purchase
 4. Clear and concise details of the fault.
 - what is the fault ?
 - when does the fault occur ?
 5. The model number, E-number, F-Number and PNC number, which you will find on the appliance's rating plate.
- So you have this information to hand we recommend you write them below.

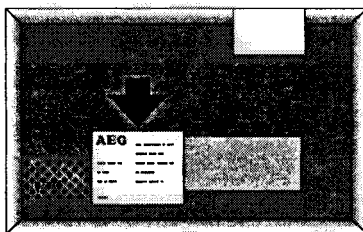

E-Nr.

F-Nr.

PNC

Guarantee Conditions

AEG offer the following guarantee to the first purchaser of this appliance:

1. The guarantee is valid for 12 months commencing when the appliance is handed over to the first retail purchaser, which must be verified by purchase invoice or similar documentation. The guarantee does not cover commercial use.
2. The guarantee covers all parts or components which fail due to faulty workmanship or faulty material. The guarantee does not cover appliances where defects or poor performance are due to misuse, accidental damage, neglect, faulty installation, unauthorised modification or attempted repair, commercial use or failure to observe requirements and recommendations set out in the instruction book. This guarantee does not cover such parts as light bulbs or removable glassware.
3. Should guarantee repairs be necessary the purchaser must inform the nearest customer service office (AEG's service or authorised agent). AEG reserves the right to stipulate the place of repair (i.e. the customer's home, place of installation or AEG workshop).
4. The guarantee or free replacement includes both labour and materials.
5. Repairs carried out under guarantee do not extend the guarantee period for the appliance. Parts removed during guarantee repairs become the property of AEG.
6. The purchaser's statutory rights are not affected by this guarantee.

European Guarantee

If you should move to another country within Europe then your guarantee moves with you to your new home subject to the following qualifications:

- The guarantee starts from the date you first purchased your product.
- The guarantee is for the same period and to the same extent for labour and parts as exist in the new country of use for this brand or range of products.
- This guarantee relates to you and cannot be transferred to another user.
- Your new home is within the European Community (EC) or European Free Trade Area.
- The product is installed and used in accordance with our instructions and is only used domestically, i.e. a normal household.
- The product is installed taking into account regulations in your new country.

Before you move, please contact your nearest Customer Care centre, listed below, to give them details of your new home. They will then ensure that the local Service Organisation is aware of your move and able to look after you and your appliances.

France Senlis	+33 (0)3 44 62 22 22
Germany Nürnberg	+49 (0)911 323 2600
Italy Pordenone	+39 (0)1678 47053
Sweden Stockholm	+46 (0)20 78 77 50
UK Newbury	+44 (0)1635 522 799

AEG Hausgeräte AG
Postfach 1036
D-90327 Nürnberg 1

© Copyright by AEG

H 259 266 340 - 11/98 - 9854602

AEG Domestic Appliances Ltd

Customer Care Department

55-77 High Street

Slough

Berkshire SL1 1DZ

Telephone: 08705 350350