

# MCD1751E / MCD1761E

Microwave oven with grill

Operating instructions



PERFEKT IN FORM UND FUNKTION

**AEG**

# Dear Customer,

Thank you for buying an AEG microwave oven and putting your trust in the AEG brand name.

Before using your AEG microwave oven for the first time, please read the instruction book thoroughly. This will enable you to take advantage of all the features that the appliance offers. It will also ensure trouble-free operation and minimize unnecessary service calls.



Important information concerning your safety or the operation of your appliance is noted by this symbol and/or mentions words such as «**Warning**», «**Take care**». Be sure to follow all instructions carefully.



Throughout the manual, this symbol guides you step by step when operating the appliance.



This symbol indicates further information concerning the use of the appliance.



The clover indicates energy-saving tips and hints for environmentally friendly use of your appliance.

In the event of malfunctioning, please follow the instructions given in the section «What to do if...»

# Contents

Important safety instructions .....	2 - 4
Oven & accessories .....	5
Control panel .....	6
Before operation .....	7
Setting the clock .....	7
What are microwaves? .....	8
Suitable ovenware .....	8
Tips & advice .....	9 - 12
Microwave power levels .....	13
Microwave cooking .....	14
Grill & dual grill cooking .....	15
Other convenient functions .....	16 - 17
Automatic operation .....	18
Automatic charts .....	19 - 21
Recipes for automatic AC-7 & AC-8 .....	21 - 22
Cooking charts .....	23 - 26
Recipes .....	27 - 37
Care & cleaning .....	38
What to do if... .....	39
Service & spare parts .....	40
Customer care .....	40
Guarantee conditions .....	41
Specifications .....	42
Important information .....	42
Installation .....	43 - 44



# Important safety instructions

## IMPORTANT SAFETY INSTRUCTIONS: READ CAREFULLY AND KEEP FOR FUTURE REFERENCE

### To avoid the danger of fire

**The microwave oven should not be left unattended during operation. Power levels that are too high or cooking times that are too long may overheat foods resulting in a fire.**

The electrical outlet must be readily accessible so that the unit can be unplugged easily in an emergency. Do not store or use the oven outdoors.

**If food being heated begins to smoke, DO NOT OPEN THE DOOR. Turn off and unplug the oven and wait until the food has stopped smoking. Opening the door while food is smoking may cause a fire.**

**Only use microwave-safe containers and utensils. See Page 8.**

**Do not leave the oven unattended when using disposable plastic, paper or other combustible food containers.**

**Clean the waveguide cover, the oven cavity, the turntable and turntable support after use. These must be dry and free from grease. Built-up grease may overheat and begin to smoke or catch fire.**

Do not place flammable materials near the oven or ventilation openings. Do not block the ventilation openings.

Remove all metallic seals, wire twists, etc., from food and food packages. Arcing on metallic surfaces may cause a fire.

Do not use the microwave oven to heat oil for deep frying. The temperature cannot be controlled and the oil may catch fire.

To make popcorn, only use special microwave popcorn makers.

Do not store food or any other items inside the oven. Check the settings after you start the oven to ensure the oven is operating as desired.

See the corresponding hints in this operation manual.

### To avoid the possibility of injury

#### **WARNING:**

Do not operate the oven if it is damaged or malfunctioning. Check the following before use:

- a) The door; make sure the door closes properly and ensure it is not misaligned or warped.
- b) The hinges and safety door latches; check to make sure they are not broken or loose.
- c) The door seals and sealing surfaces; ensure that they have not been damaged.
- d) Inside the oven cavity or on the door; make sure there are no dents.
- e) The power supply cord and plug; ensure that they are not damaged.

**Never adjust, repair or modify the oven yourself. It is hazardous for anyone other than a competent person to carry out any service or repair operation which involves the removal of a cover which gives protection against exposure to microwave energy.**

Do not operate the oven with the door open or alter the door safety latches in any way.

Do not operate the oven if there is an object between the door seals and sealing surfaces.

**Do not allow grease or dirt to build up on the door seals and adjacent parts. Follow instructions for "Care and Cleaning", Page 38. Failure to maintain the oven in a clean condition could lead to a deterioration of the surface that could adversely affect the life of the appliance and possibly result in a hazardous situation.**

Individuals with PACEMAKERS should check with their doctor or the manufacturer of the pacemaker for precautions regarding microwave ovens.

#### **To avoid the possibility of electric shock**

Under no circumstances should you remove the outer cabinet.

Never spill or insert any objects into the door lock openings or ventilation openings. In the event of a spill, turn off and unplug the oven immediately and call your local Service Force Centre.

Do not immerse the power supply cord or plug in water or any other liquid.

Do not allow the power supply cord to run over any hot or sharp surfaces, such as the hot air vent area at the top rear of the oven.



# Important safety instructions

Do not attempt to replace the oven lamp yourself or allow anyone who is not authorised by Service Force to do so. If the oven lamp fails, please consult your dealer or contact your local Service Force Centre.

If the power supply cord of this appliance is damaged, it must be replaced with a special cord. The exchange must be made by an authorised Service Force technician.

## To avoid the possibility of explosion and sudden boiling:

**WARNING: Liquids and other foods must not be heated in sealed containers since they are liable to explode.**

Never use sealed containers. Remove seals and lids before use. Sealed containers can explode due to a build up of pressure even after the oven has been turned off.

Take care when microwaving liquids. Use a wide-mouthed container to allow bubbles to escape.

**Microwave heating of beverages can result in delayed eruptive boiling, therefore care has to be taken when handling the container.**

## To prevent sudden eruption of boiling liquid and possible scalding:

1. Stir liquid prior to heating/reheating.
2. It is advisable to insert a glass rod or similar utensil into the liquid whilst reheating.
3. Let liquid stand in the oven at the end of cooking time to prevent delayed eruptive boiling.

**Do not cook eggs in their shells, and whole hard boiled eggs should not be heated in microwave ovens since they may explode even after microwave cooking has ended. To cook or reheat eggs which have not been scrambled or mixed, pierce the yolks and the whites, or the eggs may explode. Shell and slice hard boiled eggs before reheating them in the microwave oven.**

Pierce the skin of such foods as potatoes, sausages and fruit before cooking, or they may explode.

## To avoid the possibility of burns

Use pot holders or oven gloves when removing food from the oven to prevent burns.

Always open containers, popcorn makers, oven cooking bags, etc., away from the face and hands to avoid steam burns.

**To avoid burns, always test food temperature and stir before serving and pay special attention to the temperature of food and drink given to babies, children or the elderly.**

Temperature of the container is not a true indication of the temperature of the food or drink; always check the food temperature.

Always stand back from the oven door when opening to avoid burns from escaping steam and heat.

Slice stuffed baked foods after heating to release steam and avoid burns.

Keep children away from the door and accessible parts that may become hot when the grill is in use. Children should be kept away to prevent them burning themselves.

Do not touch the oven door, outer cabinet, rear cabinet, oven cavity, ventilation openings, accessories and dishes during **GRILL** mode, **DUAL GRILL** mode and **AUTOMATIC** operation as they will become hot. Before cleaning make sure they are not hot.

## To avoid misuse by children

**Warning: Only allow children to use the oven without supervision when adequate instructions have been given so that the child is able to use the oven in a safe way and understands the hazards of improper use.**

Do not lean or swing on the oven door. Do not play with the oven or use it as a toy.

Children should be taught all important safety instructions: use of pot holders, careful removal of food coverings; paying special attention to packaging (e.g. self-heating materials) designed to make food crisp, as they may be extra hot.

## Other warnings

Never modify the oven in any way.

This oven is for home food preparation only and may only be used for cooking food. It is not suitable for commercial or laboratory use.

## To promote trouble-free use of your oven and avoid damage.

Never operate the oven when it is empty except where recommended in the operation manual, see page 15 note 2. Doing so may damage the oven.

When using a browning dish or self-heating material, always place a heat-resistant insulator such as a porcelain plate under it to prevent damage to the turntable and turntable support due to heat stress. The preheating time specified in the dish's instructions must not be exceeded.



## Important safety instructions

Do not use metal utensils, which reflect microwaves and may cause electrical arcing. Do not put cans in the oven.

Only use the turntable and the turntable support designed for this oven. Do not operate the oven without the turntable.

To prevent the turntable from breaking:

- (a) Before cleaning the turntable with water, leave the turntable to cool.
- (b) Do not put hot foods or hot utensils on a cold turntable.
- (c) Do not put cold foods or cold utensils on a hot turntable.

Do not place anything on the outer cabinet during operation.

Do not use plastic containers for microwaving if the oven is still hot from using the **GRILL** mode, **DUAL GRILL** mode and **AUTOMATIC** operation, because they may melt. Plastic containers must not be used during above modes unless the container manufacturer says they are suitable.

**NOTE:**

If you are unsure how to connect your oven, please consult an authorised, qualified electrician.

Neither the manufacturer nor the dealer can accept any liability for damage to the oven or personal injury resulting from failure to observe the correct electrical connection procedure.

Water vapour or drops may occasionally form on the oven walls or around the door seals and sealing surfaces. This is a normal occurrence and is not an indication of microwave leakage or a malfunction.

# Oven & accessories

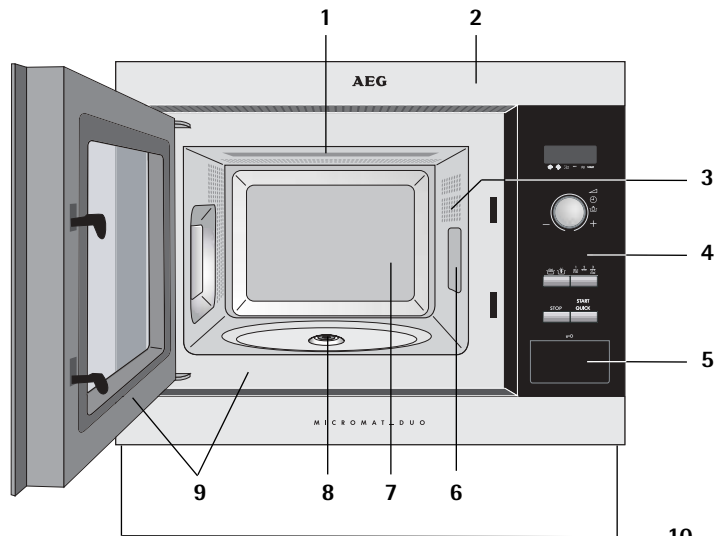

1. Grill heating element
2. Front trim
3. Oven lamp
4. Control panel
5. Door opening button
6. Waveguide cover
7. Oven cavity
8. Seal packing
9. Door seals and sealing surfaces
10. Fixing points (4 points)
11. Ventilation openings
12. Outer cover
13. Rear cabinet
14. Power supply cord support clips
15. Power supply cord

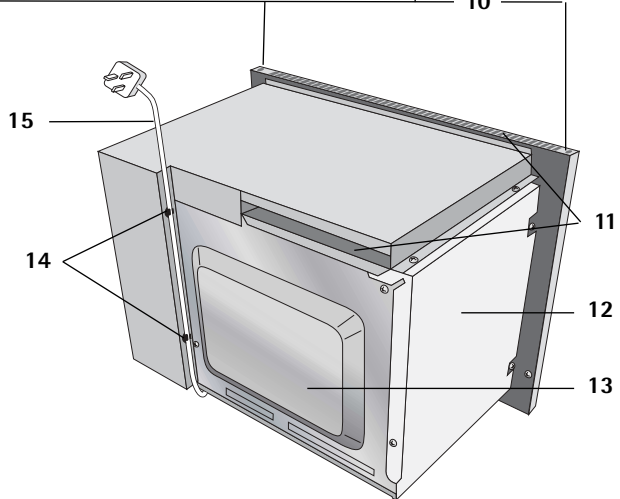

## ACCESSORIES:

Check to make sure the following accessories are provided:

(16) Turntable (17) Turntable support (18) Rack (19) 4 fixing screws (not shown)

- Place the turntable support in the seal packing on the floor of the cavity.
- Then place the turntable on the turntable support.
- To avoid turntable damage, ensure dishes or containers are lifted clear of the turntable rim when removing them from the oven.

**NOTE:** When you order accessories, please mention two items: part name and model name to your dealer or local Service Force Centre.

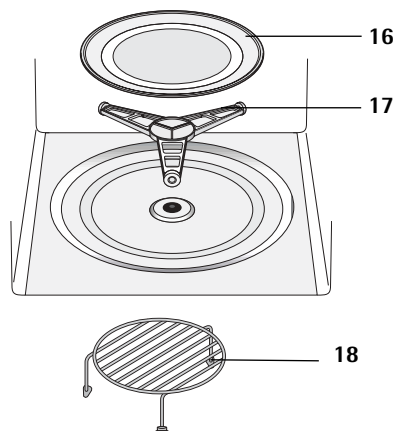



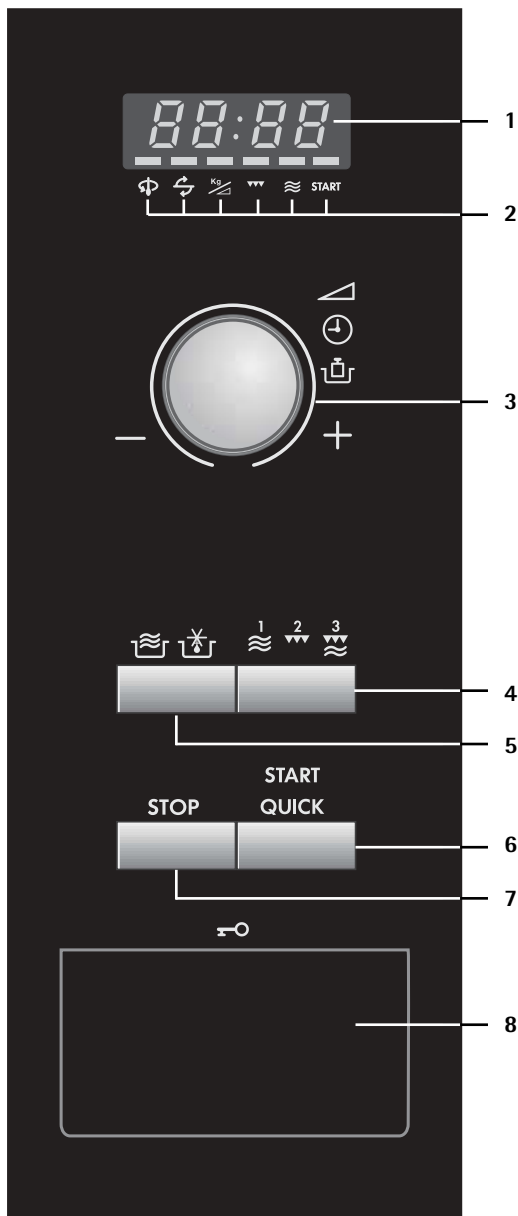



# Control panel



## 1 Digital Display

## 2 Indicators

The appropriate indicator will flash or light up, just above each symbol according to the instruction. When an indicator is flashing, press the appropriate button (having the same symbol) or carry out the necessary operation.

-  Stir
-  Turn over
-  Weight/Power level
-  Grill
-  Microwave
-  Cooking in progress

## 3 TIMER/WEIGHT/POWER knob

## 4 COOKING MODE button

Press to select either microwave, grill or dual grill, or use to set the clock.

1. press once to select microwave
2. press twice to select the grill
3. press three times to select dual grill (microwave and grill)

## 5 AUTOMATIC PROGRAMMES button

Press to select one of the 12 automatic programmes.

## 6 START/QUICK button

## 7 STOP button

## 8 DOOR OPENING button



# Before operation

Plug in the oven.

1. The oven display will flash:

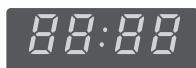

2. Press the **STOP** button, the display will show:

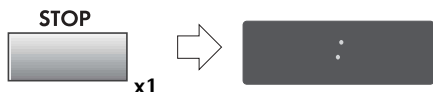

3. To set the clock, see below.
4. Heat the oven without food. (See page 15, note 2).

## Using the STOP button

Use the **STOP** button to:

1. Erase a mistake during programming.
2. Stop the oven temporarily during cooking.
3. Cancel a programme during cooking, touch twice.

# Setting the clock

There are two setting modes: 12 hour clock and 24 hour clock.

1. To set the 12 hour clock, hold the **COOKING MODE** button down for 3 seconds.

 will appear in the display.

2. To set the 24 hour clock, press the **COOKING MODE** button once more after Step 1, in the example below  will appear in the display.

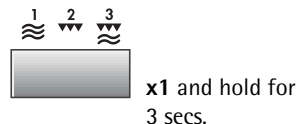

To set the clock, follow the example below.

**Example:** To set the 24 hour clock to 23:35.

1. Choose the clock function. (12 hour clock).

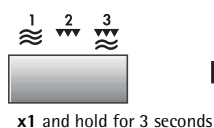

Choose the 24 hour clock.

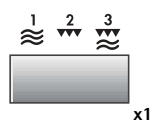

2. Set the hours. Rotate the **TIMER/WEIGHT/POWER** knob until the correct hour is displayed (23).



3. Press the **COOKING MODE** button to change from hours to minutes.

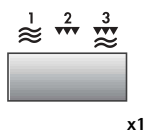

4. Set the minutes. Rotate the **TIMER/WEIGHT/POWER** knob until the correct minute is displayed (35).



5. Press the **COOKING MODE** button to start the clock.

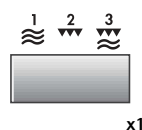

### NOTES:

1. You can rotate the **TIMER/WEIGHT/POWER** knob clockwise or counter-clockwise.
2. Press the **STOP** button if you make a mistake during programming.
3. If the electrical power supply to your microwave oven is interrupted, the display will intermittently show

 after the power is reinstated. If this occurs during cooking, the programme will be erased. The time of day will also be erased.

4. When you want to reset the time of day, follow the above example again.

# **i** What are microwaves?

Microwaves are generated in the microwave oven by a magnetron and cause the water molecules in the food to oscillate. Heat is generated by the friction which is caused, with the result that the food is thawed, heated or cooked.

## **i** Suitable ovenware

### Glass & ceramic glass

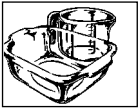

Heat-resistant glass utensils are very suitable. The cooking process can be observed from all sides. They must not, however, contain any metal (e.g. lead crystal), nor have a metallic overlay (e.g. gold edge, cobalt blue finish).

### Ceramics

Generally very suitable. Ceramics must be glazed, since with unglazed ceramics moisture can get into the ceramic. Moisture causes the material to heat up and may make it shatter. If you are not certain whether your utensil is suitable for the microwave, carry out the utensil suitability test.

### Plastic & paper containers

Plastic or paper containers which are designed for microwaves and which can withstand heat are suitable for defrosting, heating and cooking. Please follow manufacturers' instructions.

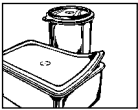

### Kitchen paper

can be used to absorb any moisture which occurs in short heating methods, e.g. of bread or products in bread crumbs. Insert the paper between the food and the revolving plate. The surface of the food will stay crispy and dry. Covering greasy food with kitchen paper will catch splashes.

### Microwave cling film

This, or heat-resistant film, is very suitable for covering or wrapping. Please follow the manufacturer's recommendations.

### Roasting bags

Can be used in a microwave oven. Metal clips are not suitable for fastening them since the roasting bag foil might melt. Fasten the roasting bag with string and pierce it several times with a fork. Non heat-resistant food wraps are not recommended for use in a microwave oven.

### Browning dish

A special microwave dish made from ceramic glass with a metal alloy base, which allows food to be browned. When using the browning dish a suitable insulator, e.g. a porcelain plate, must be placed between the turntable and the browning dish. Be careful to adhere exactly to the pre-heating time given in the manufacturer's instructions. Excessive pre-heating can damage the turntable and the turntable stand or can trigger the safety-device which will switch off the oven.

### Metal

Generally speaking, metal should not be used, since microwaves do not pass through metal and therefore cannot reach the food. There are, however, exceptions: small strips of aluminium foil may be used to cover certain parts of the food, so that these do not thaw too quickly or begin to cook (e.g. chicken wings). Small metal skewers and aluminium containers (e.g. of readycooked meals) can be used. They must, however, be small in relation to the food, e.g. aluminium



containers must be at least 2/3 to 3/4 filled with food. It is recommended that you transfer the food into a dish suitable for use in the microwave.

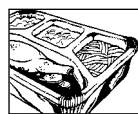

When using aluminium containers or other metal utensils there must be a gap of approx. 2 cms between them and the walls of the cooking area, otherwise the walls could be damaged by possible arcing.

**No utensil should have a metal overlay**, or metal parts such as screws, bands or handles.

### Utensil suitability test

If you are not sure whether your utensil is suitable for use in your microwave oven, carry out the following test: Place the utensil into the oven. Place a glass container filled with 150 ml of water on or next to the utensil. Switch on the oven at 800 W power for 1 to 2 minutes. If the utensil stays cool or just warm to the touch, it is suitable. Do not use this test on a plastic utensil. It could melt.

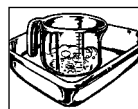

## **i** Tips & advice

### Grill function

You can use any heat-resistant container for the roasting/grilling function which is suitable for conventional roasting methods, e.g. china, ceramic, glass and metal containers.

In microwave cooking which requires the dish to be roasted or grilled, or when using the combined function, the containers must be suitable for microwaves and heat-resistant. Suitable containers are, for example, heat-resistant glass and ceramic containers.

### Before you start...

To make it as easy as possible to use the microwave oven we have put together a few hints and tips for you. Only switch on the oven when the food is already inside.

### Setting the cooking time

Defrosting, re-heating and cooking times are generally much shorter than in a conventional oven or hob. So you will need to consult this book for the recommended cooking times. It is better to set shorter rather than longer cooking times. Always test the food after the cooking time has elapsed. It is better then to continue cooking it for a little longer, than to have overcooked food.

### Initial temperatures

Thawing, heating and cooking times are dependent upon the initial temperature of the food. Deep-frozen food and food stored in a refrigerator, for example, requires longer than food which has been stored at room temperature. For heating and cooking, normal storage temperatures are assumed (refrigerator temperature approx. 5° C, room temperature approx. 20° C). For thawing the temperature of the deep freeze is assumed to be -18° C.

### Cooking times

All the times given in this book are guidelines, which can be varied according to the initial temperature, weight and condition of the food (water or fat content etc.).

### Using a food thermometer to determine cooking time

Once cooked, every drink and every foodstuff has a certain internal temperature at which the cooking process can be switched off and the food will be cooked. The internal temperature can be ascertained with a food thermometer. The most important temperatures are specified in the temperature table.

Drink / Food	Internal temperature once cooked	Internal temp. after 10 - 15 mins standing time
Heating drinks (Coffee, Water, Tea, etc.)	65-75° C	
Heating milk	60-65° C	
Heating soup	75-80° C	
Heating stew	75-80° C	
Poultry	80-85° C	85-90° C
Lamb		
Pink	70° C	70-75° C
Well done	75-80° C	80-85° C
Roast beef		
Rare	50-55° C	55-60° C
Medium	60-65° C	65-70° C
Well done	75-80° C	80-85° C
Pork, Veal	80-85° C	80-85° C

### Addition of water

Vegetables and other foods with a high water content can be cooked in their own juice or with the addition of a little water. This ensures that many vitamins and minerals are preserved.

### Food in skin or shells

Foods such as sausages, chickens, chicken legs, baked potatoes, tomatoes, apples, egg yolks or such like should be pricked or pierced with a fork or small wooden skewer. This will enable the steam which forms to dissipate without splitting the skin or shell.

### Fatty foods

Fatty meat and layers of fat cook better than lean portions of meat. Before cooking, cover the fatty portions with a piece of aluminium foil or place the food with the fat side down.

## **i** Tips & advice

### **Blanching vegetables**

Before freezing vegetables, they should be blanched. This preserves the quality and flavour at their best. Method: wash and chop the vegetables. Put 250 g of vegetables in a dish with 275 ml water and cover. Heat for 3–5 minutes. After blanching, immerse immediately in cold water to prevent further cooking and then allow to drain. Pack vegetables in an airtight container and freeze.

### **Preserving fruit and vegetables**

Using the microwave for preserving is quick and easy. There are preserving jars, rubber vacuum seals and



suitable seals made of plastic available specially made for microwaves. The manufacturers will supply precise instructions for use.

### **Large & small quantities**

Microwave times are directly dependent upon the amount of food which you would like to thaw, heat or cook. This means that small portions cook more quickly than larger ones. As a rule of thumb:  
TWICE THE AMOUNT = ALMOST TWICE THE TIME  
HALF THE AMOUNT = HALF THE TIME

### **Deep & shallow containers**

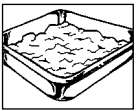

Both containers have the same capacity, but the cooking time is longer for the deeper one. You should therefore choose as flat a container as possible with a large surface area. Only use deep containers for dishes where there is a danger of overcooking, e.g. for noodles, rice, milk etc..

### **Round & oval containers**

Food cooks more evenly in round or oval containers than in containers with corners, since the microwave energy concentrates in the corners and the food in these areas could become overcooked.

### **Covering**

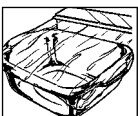

Covering the food retains the moisture within it and shortens the cooking time. Use a lid, microwave cling film or a cover. Foods which are to be crispy, e.g. roasts or chickens, should not be covered. As a general rule, whatever would be covered in a conventional oven should also be covered in a microwave oven. Whatever would be uncovered in a conventional oven can also be left uncovered in a microwave oven.

### **Irregular shaped food**

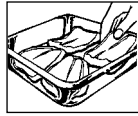

Place the thicker, more compacted end of the food pointing towards the outside. Place vegetables (such as broccoli) with the stalks pointing outward.



### **Stirring**

Stirring the food is necessary, since the microwaves begin by heating the outer areas. The temperature is thereby equalised and the food heats up evenly.

### **Arrangement of food**

Place a number of individual portions, such as small pudding moulds, cups or potatoes in their jackets, in a circle on the turntable. Keep the portions at a distance from each other so that the microwave energy can reach the food from all sides.

### **Turning**

Medium-sized items, such as hamburgers and steaks, should be turned over once during cooking, in order to shorten the cooking process. Large items, such as roasts and chickens, must be turned, since the upper side receives more microwave energy and could dry out if not turned.



### **Standing time**

Keeping to the standing time is one of the most important rules with microwaves. Almost all foods, which are defrosted, heated or cooked in the microwave, require a certain amount of time to stand, during which temperature equalisation takes place and the moisture in the food is evenly distributed.

## **i** Heating

Details for this can be found in the table: Heating food and drink (see page 23).

- Ready-prepared meals in aluminium containers should be removed from the aluminium container and heated on a plate or in a dish.
- Remove the lids from firmly closed containers.
- Food should be covered with microwave cling film, a plate or cover (obtainable from stores), so that the surface does not dry out. Drinks need not be covered.
- When boiling liquids such as water, coffee, tea or milk, place a glass stirrer in the container.
- If possible, stir large quantities from time to time, to ensure that the temperature is evenly distributed.

## **i** Defrosting

Details for this can be found in the table: Defrosting (see page 24). Your microwave is ideal for defrosting. Thawing times are usually considerably shorter than in traditional methods. Here are a few tips. Take the frozen item out of its packaging and place on a plate for defrosting.

### Boxes & containers

Boxes and containers suitable for microwaves are particularly good for defrosting and heating food, since they can withstand temperatures in a deep freeze (down to approx. -40° C) as well as being heat-resistant (up to approx. 220° C). You can therefore use the same container to freeze, defrost, heat and even cook the food, without having to transfer it.

### Covering



Cover thin parts with small strips of aluminium foil before defrosting. Thawed or warm parts should likewise be covered with aluminium strips during defrosting. This stops the thin parts becoming too hot while thicker parts are still frozen.

### Correct setting

It is better to choose a setting which is too low rather than one which is too high. By so doing you will ensure that the food defrosts evenly. If the microwave setting is too high, the surface of the food will already have begun to cook while the inside is still frozen.

- The times are for food at a room temperature of 20° C. The heating time for food stored in a refrigerator should be increased slightly.
- After heating allow the food to stand for 1-2 minutes, so that the temperature inside the food can be evenly distributed (standing time).
- The times given are guidelines which can be varied according to the initial temperature, weight, water content, fat content or the result which you wish to achieve.

### Turning/stirring



Almost all foods have to be turned or stirred from time to time. As early as possible, separate parts which are stuck together and rearrange them.

### Small amounts...

defrost more quickly and evenly than larger ones. We recommend that you freeze portions which are as small as possible. By so doing you will be able to prepare whole menus quickly and easily.

### Foods requiring careful handling,

Foods such as gateaux, cream, cheese and bread should only be partially defrosted and then left to defrost completely at room temperature. By so doing you will avoid the outer areas becoming too hot while the inside is still frozen.

### Standing time

This is particularly important after defrosting food, as the defrosting process continues during this period. In the defrosting table you will find the standing times for various foods. Thick, dense foods require a longer standing time than thinner foods or food of a porous nature. If the food has not defrosted sufficiently, you may continue defrosting it in the microwave oven or lengthen the standing time accordingly. At the end of the standing time you should process the food as soon as possible and not re-freeze it.

## **i** Cooking fresh vegetables

Details for this can be found in the table: Cooking fresh vegetables (see page 25).

- When buying vegetables try to ensure that, as far as possible, they are of similar size. This is particularly important when you want to cook the vegetables whole (e.g. boiled potatoes).
- Wash the vegetables before preparing them, clean them and only then weigh the required quantity for the recipe and chop them up.
- Season them as you would normally, but as a rule only add salt after cooking.
- Add about 5 tbsps of water for 500 g of vegetables. Vegetables which are high in fibre require a little more water. You will find information about this in the table.
- Vegetables are usually cooked in a dish with a lid. Those with a high moisture content, e.g. onions or boiled potatoes, can be cooked in microwave cling film without adding water.
- After half the cooking time has elapsed vegetables should be stirred or turned over.
- After cooking allow the vegetables to stand for approx. 2 minutes, so that the temperature disperses evenly (standing time).
- The cooking times given are guidelines and depend upon the weight, initial temperature and condition of the type of vegetable in question. The fresher the vegetables, the shorter the cooking times.

## **i** Cooking, grilling & browning

Details for this can be found in the table: Cooking, grilling and browning (see page 26).

- When buying food items, try to ensure that, as far as possible, they are of similar size. This will ensure that they are cooked properly.
- Before preparation wash meat, fish and poultry thoroughly under cold running water and pat them dry with kitchen paper. Then continue as normal.
- Beef should be well hung and have little gristle.
- Even though the pieces may be of a similar size, cooking results may vary. This is due, amongst other things, to the kind of food, variations in the fat and moisture content as well as the temperature before cooking.
- Turn large pieces of meat, fish or poultry half way through the cooking time, so that they are cooked evenly from all sides.
- After cooking cover roasts with aluminium foil and allow them to stand for approx. 10 minutes (standing time). During this period the roast carries on cooking and the liquid is evenly distributed, so that when it is carved a minimum amount of juice is lost.

## **i** Defrosting & cooking

Deep-frozen dishes can be defrosted and cooked at the same time in one process in your microwave. You will find some examples in the table. Do take note, however, of the general advice given on "heating" and "defrosting" food.

Please refer to the manufacturer's instructions on the packaging when preparing deep-frozen dishes. These usually contain precise cooking times and offer advice on preparation.

## **i** Microwave power levels

Your oven has 5 power levels. To choose the power level for cooking, follow the advice given in the recipe section. Generally the following recommendations apply:

**800 W** used for fast cooking or reheating e.g. soup, casseroles, canned food, hot beverages, vegetables, fish, etc.

**560 W** used for longer cooking of dense foods such as roast joints, meat loaf and plated meals, also for sensitive dishes such as cheese sauce and sponge cakes. At this reduced setting, the sauce will not boil over and food will cook evenly without over cooking at the sides.

**400 W** for dense foods which require a long cooking time when cooked conventionally, eg. beef dishes, it is advisable to use this power setting to ensure the meat will be tender.

**240 W** (Defrost setting) to defrost, select this power setting, to ensure that the dish defrosts evenly. This setting is also ideal for simmering rice, pasta, dumplings and cooking egg custard.

**80 W** For gentle defrosting, eg. cream gateaux or pastry.

W = WATT

To set the microwave power level:

Rotate the **TIMER/WEIGHT/POWER** knob clockwise to select cooking time.

Press the **COOKING MODE** button once (microwave only).

To change the microwave power level rotate the knob until the desired power level is reached.

Press the **START/QUICK** button.

**NOTE:** If the power level is not selected, 800 W is automatically set.

# Microwave cooking

Your oven can be programmed for up to 90 minutes. (90.00) The input unit of cooking (defrosting) time varies from 10 seconds to five minutes. It depends on the total length of the cooking (defrosting) time as shown on the table.

Cooking time	Increasing unit
0-5 minutes	10 seconds
5-10 minutes	30 seconds
10-30 minutes	1 minute
30-90 minutes	5 minutes

## Example:

Suppose you want to heat soup for 2 minutes and 30 seconds on 560 W microwave power.

1. Enter desired cooking time by rotating **TIMER/WEIGHT/POWER** knob clockwise.
2. Choose desired cooking mode by pressing **COOKING MODE** button once (microwave only).
3. Choose desired power by rotating the **TIMER/WEIGHT/POWER** knob clockwise.
4. Press **START/QUICK** button once to begin cooking.

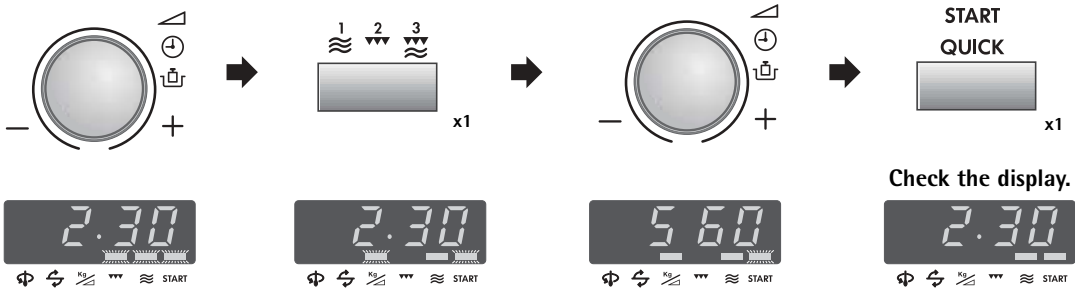

## NOTES:

1. When the door is opened during the cooking process, the cooking time on the digital display stops automatically. The cooking time starts to count down again when the door is closed and the **START/QUICK** button is pressed.
2. If you wish to know the power level during cooking, press the **COOKING MODE** button. As long as your finger is touching the **COOKING MODE** button, the power level will be displayed.
3. You can rotate the **TIMER/WEIGHT/POWER** knob clockwise or counter-clockwise. If you rotate the knob counter-clockwise, the cooking time will decrease from 90 minutes by degrees.



# Grill & dual grill cooking

This microwave oven has two **GRILL** cooking modes: 1. Grill only. 2. Dual Grill (Grill with microwave).

## 1. GRILL ONLY COOKING

This mode can be used to Grill/Brown food.

**Example:** To make toast for 4 minutes.

1. Enter desired cooking time by rotating the **TIMER/WEIGHT/POWER** knob.
2. Choose the desired cooking mode by pressing the **COOKING MODE** button twice. (Grill only).
3. Press the **START/QUICK** button once to begin cooking.

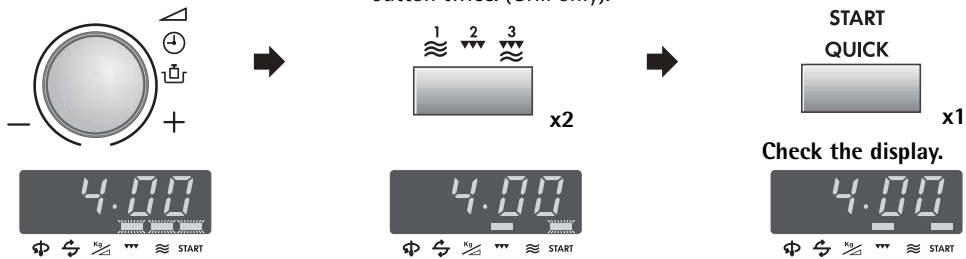

### NOTES:

1. The rack is recommended for grilling of flat pieces of food.
2. You may detect smoke or a burning smell when using the grill for the first time, this is normal and not a sign that the oven is out of order.  
To avoid this problem, when first using the oven, operate the grill without food for 20 minutes.

## 2. DUAL GRILL COOKING

This mode uses a combination of Grill power and Microwave power (80 W to 560 W).  
The Microwave power level is preset to 240 W.

### Example:

To cook kebabs (see recipe on page 32) for 7 minutes on **DUAL GRILL 400 W**.

1. Enter the desired cooking time by rotating the **TIMER/WEIGHT/POWER** knob.
2. Choose the desired cooking mode by pressing the **COOKING MODE** button three times to select Grill with Microwave.
3. Rotate the **TIMER/WEIGHT/POWER** knob to the desired microwave power level.
4. Press the **START/QUICK** button once to begin cooking.

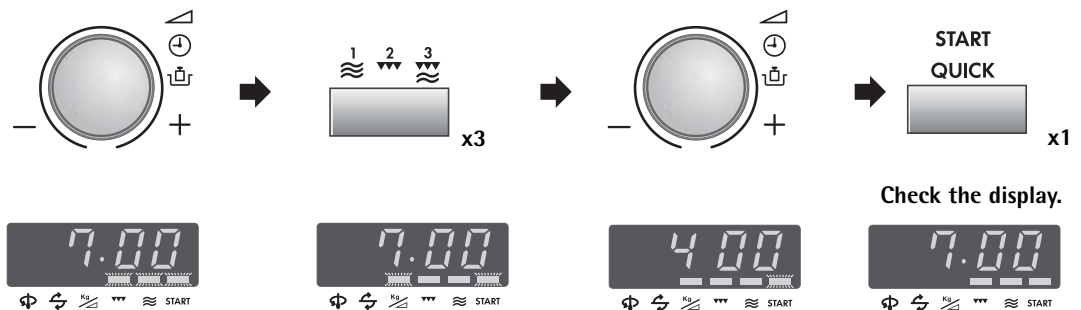

# Other convenient functions

## 1. MULTIPLE SEQUENCE COOKING

A sequence of 3 stages (maximum) can be programmed using combinations of **MICROWAVE**, **GRILL** or **DUAL GRILL**.

### Example:

To cook: 2 minutes and 30 seconds on 560 W power (Stage 1)  
5 minutes Grill only (Stage 2)

### STAGE 1

1. Enter the desired cooking time by rotating the **TIMER/WEIGHT/POWER** knob clockwise.
2. Choose the desired cooking mode by pressing the **COOKING MODE** button once (microwave only).
3. Enter the desired power level by rotating the **TIMER/WEIGHT/POWER** knob clockwise.
4. Press the **COOKING MODE** button before programming Stage 2.

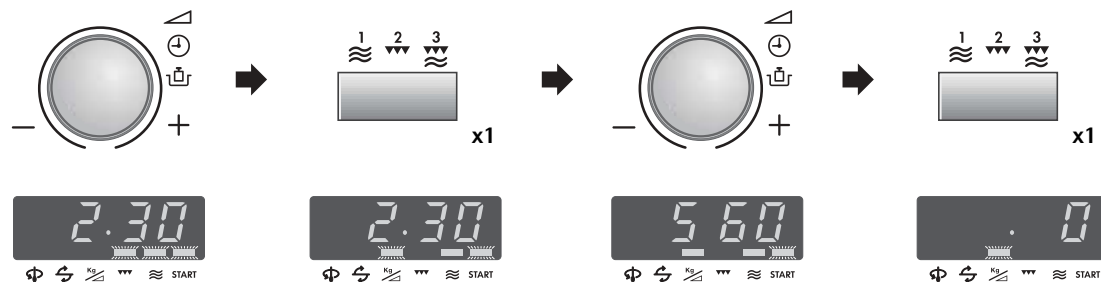

### STAGE 2

5. Enter desired time by rotating the **TIMER/WEIGHT/POWER** knob clockwise.
6. Choose the desired cooking mode by pressing the **COOKING MODE** button twice (Grill only).
7. Press the **START/QUICK** button once to begin cooking.

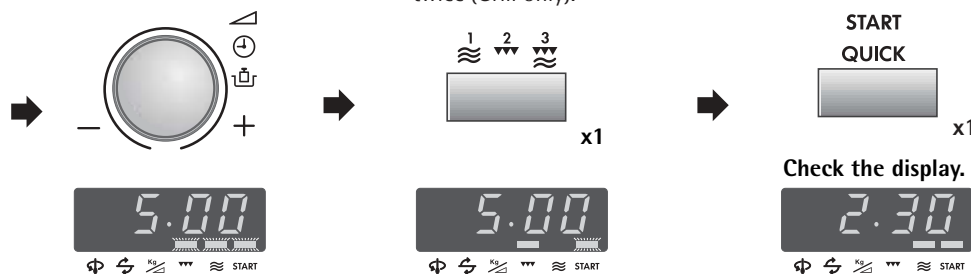

(The oven will begin to cook for 2 minutes and 30 seconds at 560 W, and then for 5 minutes on Grill only).

**NOTE:** If you set any programme after setting **GRILL** mode, omit the steps 3 and 4.

If you press the **COOKING MODE** button continually after setting **GRILL** mode, the **GRILL** mode will be changed to the **DUAL GRILL** mode automatically.

### Example:

To cook Courgette & Macaroni Bake (see recipe on page 30).

1. 25 minutes at 800 W.
2. 5 minutes Dual Grill at 400 W.

# Other convenient functions

## 2. QUICK START FUNCTION

The **START/QUICK** button allows you to operate the two following functions:

### a. Direct start

You can directly start cooking on 800 W microwave power level for 30 seconds by pressing the **START/QUICK** button.



#### NOTE:

To avoid the misuse by children the **START/QUICK** button can be used only within 3 minutes after preceding operation, i.e., closing the door, pressing the **STOP** button or cooking completion.

### b. Extend the cooking time

You can extend the cooking time during manual cooking for multiples of 30 seconds if the **START/QUICK** button is pressed while the oven is in operation.

## 3. TO CHECK THE POWER LEVEL

To check the microwave power level during cooking press the **COOKING MODE** button.

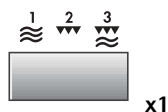

As long as your finger is touching the **COOKING MODE** button the power level will be displayed.

The oven continues to count down although the display shows the power level.

## 4. SAFETY LOCK FUNCTION

### TO SET THE SAFETY LOCK FUNCTION

1. Press and hold the **STOP** key for 3 seconds.



x1 for 3 seconds

The display will show:



### TO CANCEL THE SAFETY LOCK FUNCTION

1. Press and hold the **STOP** key for 3 seconds.



x1 for 3 seconds

The display will show the time of day, if set.

**NOTE:** When Safety Lock is set you cannot input any buttons except the **STOP** button.

# Automatic operation

The **AUTOMATIC** function automatically works out the correct cooking mode and cooking time. You can choose from 8 **AUTOCOOK** menus and 4 **AUTO DEFROST** menus. What you need to know when using this automatic function:

1. Press the **AUTOMATIC PROGRAMMES** button once, the display will appear as shown.

The menu can be chosen by pressing the **AUTOMATIC PROGRAMMES** button until the desired menu number is displayed. See pages 19 - 21 "Automatic charts".

To select a defrost menu, press the **AUTOMATIC PROGRAMMES** button at least 9 times. If you press the button 9 times, **Ad - 1** will appear in the display. The menu will be changed automatically by holding down the **AUTOMATIC PROGRAMMES** button.

2. The weight of the food can be input by rotating the **TIMER/WEIGHT/POWER** knob until the desired weight is displayed.

- Enter the weight of the food only. Do not include the weight of the container.
- For food weighing more or less than weights given in the automatic charts, use manual programmes. For best results, follow the cooking charts on pages 23 - 26.

3. To start cooking press **START/QUICK** button.

When action is required (e.g. to turn food over), the oven stops and the audible signals sound, remaining cooking time and any indicator will flash on the display. To continue cooking, press the **START/QUICK** button.

Example:

To cook grill skewers weighing 0,2 kg using **AUTOCOOK AC-2**.

1. Select the menu required by pressing the **AUTOMATIC PROGRAMMES** button twice.



2. Enter the weight by rotating the **TIMER/WEIGHT/POWER** knob.

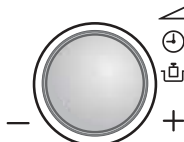

3. Press the **START/QUICK** button once.



Check the display.



1.



2.













3.





















The final temperature will vary according to the initial food temperature. Check food is piping hot after cooking. If necessary, you can extend the cooking manually.

# Automatic charts



BUTTON	MENU NO.	WEIGHT (Increasing Unit)/ UTENSILS	PROCEDURE
 x1	<b>AC-1 Cook</b> French Fried Potatoes (recommended for conventional ovens) 	0,10 - 0,30 kg (50 g) (initial temp -18° C) Flan dish Rack	<ul style="list-style-type: none"> <li>Remove the frozen french fried potatoes from the package and place them in a flan dish.</li> <li>Place the dish on the rack in the oven.</li> <li>When audible signal sounds, turn over.</li> <li>After cooking, remove from the dish and put on a plate for serving. (No standing time is necessary).</li> <li>Add salt to taste.</li> </ul> <p><b>NOTE:</b> The dish gets very hot during cooking. To avoid burning yourself, please use oven gloves for removing the dish from the oven.</p>
 x2	<b>AC-2 Cook</b> Grill Skewers 	0,2 - 0,6 kg (100 g) (initial temp 5° C) Rack	<ul style="list-style-type: none"> <li>Prepare the grill skewers referring to the recipe on page 31.</li> <li>Place on the rack and cook.</li> <li>When the audible signal sounds, turn over.</li> <li>After cooking, remove and put on a plate for serving. (No standing time necessary).</li> </ul>
 x3	<b>AC-3 Cook</b> Chicken Legs  Ingredients for 0,6 kg chicken legs: 3 pieces, 1-2 tbsp oil, ½ tsp salt, 1 tsp sweet paprika, 1 tsp rosemary	0,20 - 0,60 kg (50 g) (initial temp 5° C) Rack	<ul style="list-style-type: none"> <li>Mix the ingredients and spread on the chicken legs.</li> <li>Pierce the skin of the chicken legs.</li> <li>Put the chicken legs on the rack, skin side down, with the thin ends towards the centre.</li> <li>When audible signal sounds, turn over.</li> <li>After cooking, remove and stand for approx. 5 minutes.</li> </ul>
 x4	<b>AC-4 Cook</b> Grilled Chicken  Ingredients for 1,2 kg grilled chicken: Salt and Pepper, 1 tsp sweet paprika, 2 tbsp oil	0,9 - 1,4 kg (100 g) (initial temp 5° C) Saucer Flan Dish	<ul style="list-style-type: none"> <li>Mix the ingredients and spread on the chicken.</li> <li>Pierce the skin of the chicken.</li> <li>Put chicken breast side down on an upturned saucer in a flan dish.</li> <li>Place directly on the turntable and cook.</li> <li>When audible signal sounds, turn over.</li> <li>After cooking, leave for approx. 3 minutes in the oven, remove and put on a plate for serving.</li> </ul>
 x5	<b>AC-5 Cook</b> Fresh Vegetables 	0,1 - 0,6 kg (100 g) (initial temp 20° C) Bowl & lid	<ul style="list-style-type: none"> <li>Cut into small pieces, eg. strips, cubes or slices.</li> <li>Add 1 tbsp water per 100 g and salt as desired. (For mushrooms no additional water is necessary).</li> <li>Cover with a lid.</li> <li>When audible signal sounds, stir and re-cover.</li> <li>After cooking, let the food stand for approx 2 minutes.</li> </ul>

# Automatic charts

BUTTON	AUTOCOOK NO.	WEIGHT (Increasing Unit)/ UTENSILS	PROCEDURE
  <b>x6</b>	<b>AC-6 Cook</b> Boiled Potatoes Jacket Potatoes 	0,1 - 0,8 kg (100 g) (initial temp 20° C) Bowl & lid	Boiled Potatoes: Peel the potatoes and cut them into similar sized pieces. Jacket Potatoes: Choose potatoes of similar size and wash them. <ul style="list-style-type: none"> <li>Put the boiled or jacket potatoes into a bowl.</li> <li>Add the required amount of water (per 100 g), approx 2 tbsps and a little salt.</li> <li>Cover with a lid</li> <li>When audible signal sounds, stir and re-cover.</li> <li>After cooking, let the potatoes stand for approx. 2 minutes.</li> </ul>
  <b>x7</b>	<b>AC-7 Cook</b> Gratinated Fish Fillet 	0,6 - 1,2 kg* (100 g) (initial temp Fish 5° C) Gratin dish	<ul style="list-style-type: none"> <li>See recipes for Gratinated Fish Fillet on page 21.</li> </ul> * Total weight of all ingredients.
  <b>x8</b>	<b>AC-8 Cook</b> Gratin 	0,5 - 1,5 kg* (100 g) (initial temp 20° C) Gratin dish	<ul style="list-style-type: none"> <li>See recipes for Gratin on page 22.</li> </ul> * Total weight of all ingredients.

BUTTON	AUTO DEFROST NO.	WEIGHT (Increasing Unit)/ UTENSILS	PROCEDURE
  <b>x9</b>	<b>Ad-1 Defrost</b> Steak, Chops 	0,2 - 0,8 kg (100 g) (initial temp -18° C) (See note on page 21)	<ul style="list-style-type: none"> <li>Place the food in a flan dish in the centre of the turntable.</li> <li>When the audible signal sounds, turn the food over, rearrange and separate. Shield thin parts and warm spots with small pieces of aluminium foil.</li> <li>After defrosting, wrap in aluminium foil for 10 - 15 minutes, until thoroughly defrosted.</li> </ul>
  <b>x10</b>	<b>Ad-2 Defrost</b> Minced Meat 	0,2 - 0,8 kg (100 g) (initial temp -18° C) (See note on page 21)	<ul style="list-style-type: none"> <li>Place the block of minced meat in a flan dish in the centre of the turntable.</li> <li>When the audible signal sounds, turn the food over. Remove the defrosted parts if possible.</li> <li>After defrosting, cover with aluminium foil and stand for 5 - 10 minutes, until thoroughly defrosted.</li> </ul>
  <b>x11</b>	<b>Ad-3 Defrost</b> Cake 	0,1 - 1,4 kg (100 g) (initial temp -18° C) Flat dish	<ul style="list-style-type: none"> <li>Remove all packaging from the cake.</li> <li>Place directly on the turntable, or on a plate in the middle of the turntable.</li> <li>After defrosting, cut the cake into similar sized pieces keeping space between each piece and let stand for 10 - 30 minutes until evenly defrosted.</li> </ul>

## Automatic charts

BUTTON	AUTO DEFOST NO.	WEIGHT (Increasing Unit)/ UTENSILS	PROCEDURE
 	<b>Ad-4 Defrost Bread</b> 	0,1 - 1,0 kg (100 g) (initial temp -18° C) Flat dish (Only sliced bread is recommended for this programme.)	<ul style="list-style-type: none"> <li>• Distribute in a flan dish in the centre of the turntable. For 1,0 kg distribute directly on the turntable.</li> <li>• When the audible signal sounds, turn over, re-arrange and remove defrosted slices.</li> <li>• After defrosting cover in aluminum foil and stand for 5 - 15 minutes, until thoroughly defrosted.</li> </ul>

### NOTES: Auto Defrost

1. Steaks and Chops should be frozen in one layer.
2. Minced meat should be frozen in a thin shape.
3. After turning over, shield the defrosted portions with small, flat pieces of aluminium foil.
4. Gateaux topped and coated with cream are very sensitive to microwave energy. For the best result, if the cream begins to soften rapidly, it is best to remove it from the oven immediately and stand for 10 - 30 minutes at room temperature.

## Recipes for automatic AC-7 & AC-8

### GRATINATED FISH FILLET (AC-7)

#### Fish gratin Italian style

##### Ingredients

0,6 kg	0,9 kg	1,2 kg	
260 g	390 g	520 g	fish fillet
1/2 tbsp	1 tbsp	1 1/2 tbsp	lemon juice
1/2 tbsp	1 tbsp	1 1/2 tbsp	anchovy butter
30 g	45 g	60 g	Gouda (grated)
			salt & pepper
180 g	270 g	360 g	fresh tomatoes
1 tbsp	1 1/2 tbsp	2 tbsp	chopped mixed herbs
110 g	165 g	220 g	Mozarella
1/2 tbsp	3/4 tbsp	1 tbsp	basil (chopped)

##### Preparation

1. Wash and dry the fish and sprinkle with lemon juice, salt and grease with anchovy butter.
2. Place in a gratin dish.
3. Sprinkle the Gouda over the fish.
4. Wash the tomatoes and remove the stalk-spore. Cut into slices and place on top of the cheese.
5. Season with salt, pepper and the mixed herbs.
6. Drain the Mozarella, cut into slices and place on the tomatoes. Sprinkle the basil over the cheese.
7. Place the gratin dish on the turntable and cook on **AUTOMATIC COOK AC-7**, "Gratinated fish fillet".
8. After cooking let stand for approx. 5 minutes.

### GRATINATED FISH FILLET (AC-7)

#### Fish esterhazy

##### Ingredients

0,6 kg	0,9 kg	1,2 kg	
270 g	400 g	540 g	fish fillet
120 g	180 g	240 g	leeks (cut into rings)
24 g	36 g	48 g	onion (finely sliced)
60 g	90 g	120 g	carrot (grated)
10 g	10 g	10 g	butter or margarine
			salt, pepper & nutmeg
1 tbsp	1 1/2 tbsp	2 tbsp	lemon juice
60 g	90 g	120 g	crème fraîche
60 g	90 g	120 g	Gouda (grated)

##### Preparation

1. Put vegetables, butter and the spices into a casserole dish and mix well. Cook for 2-6 minutes on 800 W depending on weight.
2. Wash the fish, dry and sprinkle with lemon juice and salt.
3. Mix the crème fraîche with the vegetables and season again.
4. Put half of the vegetables in a gratin dish. Place the fish on top and cover with the remaining vegetables.
5. Spread the Gouda over the top, place on the turntable and cook on **AUTOMATIC COOK AC-7**, "Gratinated Fish Fillet".
6. After cooking let stand for approx. 5 minutes.

# **i** Recipes for automatic AC-7 & AC-8

## GRATIN (AC-8)

### Spinach gratin

#### Ingredients

0,5 kg	1,0 kg	1,5 kg	
150 g	300 g	450 g	leaf spinach (defrosted, drained)
15 g	30 g	45 g	onion (finely chopped)
			salt, pepper & nutmeg
150 g	300 g	450 g	boiled potatoes (sliced)
35 g	75 g	110 g	cooked ham (diced)
50 g	100 g	150 g	crème fraîche
1	2	3	eggs
40 g	75 g	115 g	grated cheese

#### Preparation

1. Mix together the leaf spinach with the onion and season with salt, pepper and nutmeg.
2. Grease the gratin dish. Place alternate layers of potato slices, diced ham and spinach in the dish. The top layer should be spinach.
3. Mix the eggs with crème fraîche, add salt and pepper and pour over the vegetables.
4. Cover the gratin with the grated cheese.
5. Place on the turntable and cook on **AUTOMATIC COOK AC-8**, "Gratin".
6. After cooking, let stand for 5-10 minutes.

## GRATIN (AC-8)

### Potato-courgette-gratin

#### Ingredients

0,5 kg	1,0 kg	1,5 kg	
200 g	400 g	600 g	boiled potatoes (sliced)
115 g	230 g	345 g	courgette (finely sliced)
75 g	150 g	225 g	crème fraîche
1	2	3	eggs
1/2	1	1 1/2	clove of garlic (crushed)
			salt & pepper
40 g	75 g	115 g	grated Gouda cheese
			sunflower kernel

#### Preparation

1. Grease the gratin dish and place alternate layers of potato slices and courgette in the dish.
2. Mix the eggs with crème fraîche, season with salt, pepper and garlic and pour over the vegetables.
3. Cover the gratin dish with the grated Gouda cheese.
4. Finally sprinkle the gratin with sunflower kernel.
5. Place on the turntable and cook on **AUTOMATIC COOK AC-8**, "Gratin".
6. After cooking, let stand for 5-10 minutes.

























# Cooking charts

## ABBREVIATIONS USED

tblsp = tablespoon	l = litre	min = minutes
tsp = teaspoon	ml = millilitre	sec = seconds
Cup = cupful	cm = centimetre	dm = diameter
kg = kilogram	DFC = dry fat content	app. = approximate
g = gram	DF = deep frozen	sach. = sachet























### TABLE: HEATING FOOD & DRINK

Food / Drink	Quantity -g/ml-	Setting	Power -Level-	Time -Min-	Hints
Coffee, 1 cup	150		800 W	approx. 1	Do not cover
Milk, 1 cup	150		800 W	approx. 1	Do not cover
Water, 1 cup	150		800 W	1 <sup>1</sup> / <sub>2</sub> -2	Do not cover, bring to the boil
6 cups	900		800 W	10-12	Do not cover, bring to the boil
1 dish	1000		800 W	11 <sup>1</sup> / <sub>2</sub> -13	Cover, bring to the boil
One-plate meal (Vegetables, Meat and side dishes)	400		800 W	3-6	Sprinkle sauce with water, cover, stir half way through cooking time
Stew	200		800 W	1 <sup>1</sup> / <sub>2</sub> -2 <sup>1</sup> / <sub>2</sub>	Cover, stir after heating
Soup, clear	200		800 W	1 <sup>1</sup> / <sub>2</sub> -2	Cover, stir after heating
Cream soup	200		800 W	1 <sup>1</sup> / <sub>2</sub> -2 <sup>1</sup> / <sub>2</sub>	Cover, stir after heating
Vegetables	200		800 W	2-2 <sup>1</sup> / <sub>2</sub>	Add water if necessary, cover, stir half way through cooking time
	500		800 W	4-5	
Side dishes	200		800 W	2-2 <sup>1</sup> / <sub>2</sub>	Sprinkle with a little water, cover, stir half way through cooking time
	500		800 W	4-4 <sup>1</sup> / <sub>2</sub>	
Meat, 1 slice <sup>1</sup>	200		800 W	3-4	Sprinkle with a little sauce, cover
Fish fillet	200		800 W	2-3	Cover
Sausages, 2 pieces	180		800 W	approx. 2	Pierce skin several times
Cake, 1 slice	150		400 W	<sup>1</sup> / <sub>2</sub>	Place on a plate
Baby food, 1 jar	190		400 W	approx. 1	Remove lid, stir well after heating Check the temperature
Melting Margarine or Butter <sup>1</sup>	50		800 W	<sup>1</sup> / <sub>2</sub> -1	
Melting chocolate	100		400 W	2-3	Stir during cooking
Dissolving 6 sheets of gelatine	10		400 W	<sup>1</sup> / <sub>2</sub>	Soak in water, squeeze out well and put in soup bowl, stir during cooking
Cake glaze for <sup>1</sup> / <sub>4</sub> l liquid	10		400 W	5-6	Stir with sugar and 250ml liquid, cover and, stir well during and after cooking

<sup>1</sup> from chilled

# Cooking charts





















**TABLE: DEFROSTING**

Food / Drink	Quantity -g-	Setting	Power -Level-	Time -Min-	Hints	Standing time -Min-
Meat for roasting	1500		80 W	58-64	Place on an upturned plate, turn over	30-90
(e.g. Pork, Beef,	1000		80 W	42-48	halfway through defrosting	30-90
Lamb, Veal)	500		80 W	19-23		30-90
Steaks, Cutlets,	200		240 W	4-5	Turn over halfway through defrosting	10-15
Liver						
Goulash	500		240 W	8-12	Stir halfway through defrosting	15-30
Sausages, 8	600		240 W	6-9	Place next to each other, turn over half	5-10
4	300		240 W	4-5	way through defrosting	5-10
Duck/Turkey	1500		80 W	48-52	Place on an upturned plate, turn over	30-90
					halfway through defrosting	
Chicken	1200		80 W	39-43	Place on an upturned plate, turn over	30-90
					halfway through defrosting	
	1000		80 W	33-37	Place on an upturned plate, turn over	30-90
					halfway through defrosting	
Chicken legs	200		240 W	4-5	Turn over halfway through defrosting	10-15
Fish in pieces	800		240 W	9-12	Turn over halfway through defrosting	10-15
Fish fillet	400		240 W	7-10	Turn over halfway through defrosting	5-10
Crab	300		240 W	6-8	Turn over halfway through defrosting	5
					and remove defrosted parts	
Bread rolls, 2	80		240 W	approx. 1	Only begin to defrost	-
Coarse wholemeal bread	250		240 W	2-4	Place slices next to each other,	5
in slices					only begin to defrost	
Slices of Toast bread						
Mixed flour bread, whole loaf	500		240 W	6-8	Turn over halfway through defrosting	15
White bread, whole loaf					(centre will still be frozen)	
Cake, 1 slice	150		80 W	2-5	Place on a plate	5
Cream cake, 1 slice			80 W	3-4	Place on a plate	10
Whole cake, Ø 25 cm			80 W	18-20	Place on a plate. When half defrosted,	30-60
					cut in to slices and leave until cake is	
					fully defrosted	
Cream	200		240 W	2+2	Remove lid. When half defrosted, put in	5-10
					a dish and allow to finish defrosting	
Butter	250		240 W	2-4	Only begin to defrost	15
Fruit e.g. strawberries	250		240 W	4-5	Place next to each other, spread out evenly	5
raspberries, cherries, plums					Turn over halfway through defrosting	











The times shown in the table are guidelines which may vary according to freezing temperature, quality and weight of the foodstuffs.

# Cooking charts

**TABLE: COOKING FRESH VEGETABLES**

Vegetable	Quantity -g-	Setting 	Power -Level-	Time -Min-	Hints	Added water -Tbsps/ml-
Artichokes	300		800 W	6-8	remove the stalk, cover	3-4 tbsp
Leaf Spinach	300		800 W	5-7	wash, dry well, cover, stir once or twice during cooking	-
Cauliflower	800		800 W	15-17	1 whole head, cover, divide into florets	5-6 tbsp
	500		800 W	10-12	stir during cooking	4-5 tbsp
Broccoli	500		800 W	9-11	divide into florets, cover, stir occasionally during cooking	4-5 tbsp
Mushrooms	500		800 W	8-10	whole heads, cover, stir occasionally during cooking	-
Chinese leaves	300		800 W	9-11	cut into strips, cover, stir occasionally during cooking	4-5 tbsp
Peas	500		800 W	9-11	cover, stir occasionally during cooking	4-5 tbsp
Fennel	500		800 W	9-11	cut into quarters, cover, stir occasionally during cooking	4-5 tbsp
Onions	250		800 W	5-7	whole, cook in microwave cling film	-
Carrots	500		800 W	10-12	cut into rings, cover, stir occasionally during cooking	4-5 tbsp
Green peppers	500		800 W	7-9	cut into strips, stir once or twice during cooking	4-5 tbsp
Jacket potatoes	500		800 W	9-11	cover, stir occasionally during cooking	4-5 tbsp
Leeks	500		800 W	9-11	cut into rings, cover, stir occasionally during cooking	4-5 tbsp
Red cabbage	500		800 W	15-17	cut into strips, stir once or twice during cooking	50 ml
Brussels sprouts	500		800 W	9-11	whole sprouts, cover, stir occasionally during cooking	50 ml
Boiled potatoes (salted)	500		800 W	9-11	cut into large pieces of a similar size, add a little salt, cover, stir occasionally during cooking	150 ml
Celery	500		800 W	9-11	dice finely, cover, stir occasionally during cooking	50 ml
White cabbage	500		800 W	15-17	cut into strips, cover, stir occasionally during cooking	50 ml
Courgettes	500		800 W	9-11	slice, cover, stir occasionally during cooking	4-5 tbsp

**TABLE: COOKING & DEFROSTING**

Food (frozen)	Quantity -g-	Setting -Level-	Power	Time -Min-	Added water -tbsps-	Hints	Standing time -Min-
Fish fillet	300		800 W	10-12	-	-	Cover
Trout, 1 piece	250		800 W	5-7	-	-	Cover
One-plate meal	400		800 W	9-11	-	-	Cover, stir after 6 minutes
Fresh spinach	300		800 W	6-8	-	-	Cover, stir once or twice during cooking
Broccoli	300		800 W	7-9	3-5 Tbsp	-	Cover, stir halfway through time
Peas	300		800 W	7-9	3-5 Tbsp	-	Cover, stir halfway through time
Kohlrabi	300		800 W	7-9	3-5 Tbsp	-	Cover, stir halfway through time
Mixed veg.	500		800 W	11-13	3-5 Tbsp	-	Cover, stir halfway through time
Brussel sprouts	300		800 W	7-9	3-5 Tbsp	-	Cover, stir halfway through time
Red cabbage	450		800 W	10-12	3-5 Tbsp	-	Cover, stir halfway through time

# Cooking charts

**TABLE: COOKING, GRILLING AND BROWNING**

Food	Quantity -g-	Setting	Power -Level-	Time -Min-	Hints	Standing time -Min-
Roasts (Pork, Veal, Lamb)	500		800 W	6-8	Season to taste, place in shallow dish, place on the turntable, turn over after *	5-10
			400 W	3-5*		
			560 W	4-7		
			400 W	2-4		
	1000		800 W	13-16		
			400 W	6-8*		
			560 W	10-12		
			400 W	3-5		
	1500		800 W	24-26		
			400 W	9-11*		
			560 W	14-16		
			400 W	5-7		
Roast beef (medium)	1000		560 W	7-10	Season to taste, place fatty side down in shallow dish, place on the turntable, turn over after *	10
			400 W	7-8*		
			560 W	4-5		
			400 W	5-7		
	1500		560 W	8-10		
			400 W	8-10*		
Chicken	1200		800 W	8-11	Season to taste, place breast side down in shallow dish, place on the turntable, turn over after *	3
			400 W	5-7*		
			800 W	8-11		
			400 W	4-5		
Chicken legs	200		400 W	5-6	Season to taste, place skin downwards on rack, turn over after *	3
				1-2*		
				6-8		
Steaks 2 medium pieces	400			13-15*	Place on rack, turn over after *, season after grilling	2
				8-12		
To brown dishes etc.				5-7	place dish on rack	10
Croque monsieur, 1 slice				6-9	Toast bread, spread with butter, lay 1 slice of cooked ham, 1 slice of pineapple and 1 slice of processed cheese on top and grill	1
Frozen Pizza	365		400 W	8	Remove packaging, place pizza on rack. Suitable for repeat cooking of upto 4 pizzas. To maintain good results, rest the oven for 1 minute 30 seconds, before cooking 5th pizza (see power down note on page 39).	
			400 W	2 1/2		

# Recipes

## ADAPTING RECIPES FOR THE MICROWAVE OVEN

If you would like to adapt your favourite recipes for the microwave, you should take note of the following: Shorten cooking times by a third to a half. Follow the example of the recipes in this book. Foods which have a high moisture content such as meat, fish, poultry, vegetables, fruit, stews and soups can be prepared in your microwave without any difficulty.

Foods which have little moisture, such as platters of food, should have the surface moistened prior to heating or cooking.

The amount of liquid to be added to raw foods, which are to be braised, should be reduced to about two thirds of the quantity in the original recipe.

If necessary, add more liquid during cooking.

The amount of fat to be added can be reduced considerably. A small amount of butter, margarine or oil is sufficient to flavour food. For this reason your microwave is excellent for preparing low-fat foods as part of a diet.

## HOW TO USE THE RECIPES

- All the recipes in this book are calculated on the basis of 4 servings – unless otherwise stated.
- Recommendations relating to suitable utensils and the total cooking times are given at the beginning of every recipe.
- As a rule the quantities shown are assumed to be wholly consumable, unless specifically indicated otherwise.
- When eggs are given in the recipes they are assumed to have weight of approx. 55 g (medium).

## Soups & starters

Spain

### Cream of avocado soup

Total cooking time: approx. 10–12 minutes

Utensils: Bowl with lid (2 litre capacity)

Ingredients

- 3 avocados (600 g of flesh)  
a little lemon juice
- 700 ml meat stock
- 70 ml cream  
salt & pepper

1. Peel the soft, ripe avocados, remove stone, cut into small pieces and puree with a mixer or a mixing attachment on a hand mixer. Reserve two thin slivers per portion for decoration and sprinkle with lemon juice.
2. Put the meat stock, avocados and the cream in a dish, season with salt and pepper and cook with lid on. Stir once during cooking.  
**10–12 min.**  **800 W**
3. Mix soup until creamy and decorate with the remaining avocado slivers. Allow to stand for 5 minutes after cooking.

# Soups & starters

Switzerland

## Barley soup

Total cooking time: approx. 35-40 minutes

Utensils: Bowl with lid (2 litre capacity)

Ingredients

- 2 tbsp butter or margarine (20 g)
- 1 onion (50 g), finely chopped
- 1-2 carrots (130 g), sliced
- 15 g celery, diced
- 1 leek (130 g), in rings
- 3 white cabbage leaves (100 g) in strips
- 200 g veal bones
- 50 g streaky bacon, in strips
- 50 g barley grains
- 700 ml meat stock
- pepper
- 4 wiener sausages (300 g)

Netherlands

## Mushroom soup

Total cooking time: approx. 13-17 minutes

Utensils: Bowl with lid (2 litre capacity)

Ingredients

- 200 g mushrooms, sliced
- 1 onion (50 g), finely chopped
- 300 ml meat stock
- 300 ml cream
- 2½ tbsp plain flour (25 g)
- 2½ tbsp butter or margarine (25 g)
- salt & pepper
- 1 egg yolk
- 150 g crème fraiche

Germany



## Camembert toast



Total cooking time: approx. 1½-2½ minutes

Utensils: Flat dish

Ingredients

- 4 slices of bread for toasting (80 g)
- 2 tbsp butter or margarine (20 g)
- 150 g camembert
- 4 tsp cranberry jelly (40 g)
- cayenne pepper

1. Put the butter and diced onion in the dish and steam with the lid on the dish.  
**approx. 1-2 min.**  **800 W**
2. Add the vegetables to the dish. Then add the bones, the strips of bacon and the barley and fill with the meat stock. Season with pepper and cook with the lid on.  
**1. 17-19 min.**  **800 W**  
**2. 17-19 min.**  **400 W**
3. Chop the sausages into small pieces and heat them for 5 minutes in the dish.
4. After cooking, let the soup stand for 5 minutes. Take the bones out of the soup before serving.

1. Put the vegetables with the meat stock in the dish and cook with the lid on.  
**8-9 min.**  **800 W**
2. Puree all the ingredients in a food processor. Add the cream.
3. Rub the flour and butter into a dough and stir into the mushroom soup until smooth. Season with salt and pepper, cover and cook. Stir again after cooking.  
**4-6 min.**  **800 W**
4. Mix the egg yolk with the crème fraiche, stir into the soup little by little. Heat the whole mixture again for a short time, but do not allow it to boil!  
**1-2 min.**  **800 W**  
Allow the soup to stand for approximately 5 minutes once cooked.

1. Toast the bread and spread with butter.
  2. Cut the Camembert into slices and arrange on top of the toast. Put the Cranberry jelly in the middle of the cheese and sprinkle with Cayenne pepper.
  3. Place the toast on a plate and heat.  
**approx 1½-2½ min.**  **800 W**
- Tip: You can vary this recipe according to your taste. For example, you can use fresh mushrooms and grated cheese or cooked ham, asparagus and Emmental cheese.

# Meat, fish & poultry

France

## Fresh tuna with vegetables

Total cooking time: approx. 21–23 minutes

Utensils: Shallow oval gratin dish with lid  
(approx. 26 cm diameter)

### Ingredients

500 g fresh tuna, in slices  
2 tbsp lemon juice  
salt  
1 tsp vegetable oil to grease the dish  
1/2 green pepper (125 g), cut into strips  
2 onions (125 g), finely chopped  
1 carrot (50 g), sliced  
1–2 tomatoes (125 g), diced  
40 ml white wine  
1 clove of garlic  
bouquet garni  
salt & pepper

1. Wash the tuna, pat dry and sprinkle with lemon juice. Allow the fish to stand for approximately 15 minutes, then pat dry again and add salt.
2. Spread oil on the bottom of the dish and lay the tuna in it. Arrange the vegetables on top of the fish. Add the white wine, the clove of garlic and the bouquet garni and season. Cover the dish and cook.

**21–23 min.**  **560 W**

Allow the fish to stand for approximately 2 minutes after cooking. Remove the bouquet garni and the clove of garlic before serving.

Tip: A bouquet garni is made of:

a sprig of parsley, a bunch of herbs and vegetables for making soup, lovage, thyme and a few bay leaves.

Spain







## Mushroom with rosemary

Total cooking time: approx. 15–21 minutes

Utensils: Bowl with lid (1 litre capacity)  
Shallow round dish  
(approx. 22 cm diameter)

### Ingredients

8 large mushrooms (approx. 225 g), whole  
2 tbsp butter or margarine (20 g)  
1 onion (50 g), finely chopped  
50 g bacon, finely diced  
black pepper, ground  
fresh rosemary, bruised  
125 ml dry white wine  
125 ml cream  
2 tbsp flour (20 g)

1. Remove the stalks from the mushrooms and chop the stalks into small pieces.
2. Spread the butter on the bottom of the dish. Add the onions, the diced bacon and the mushroom stalks. Season with pepper and rosemary, cover and cook.  
**4–6 min.**  **800 W**  
Leave to cool.
3. Heat 100 ml of the wine and cream in the other dish with its lid on.  
**2–3 min.**  **800 W**
4. Mix the remaining wine with the flour, stir into the hot liquid and cook with the lid on. Stir once during cooking.  
**1–2 min.**  **800 W**
5. Fill the mushrooms with the bacon mixture, place in the sauce and cook on the rack.  
**2–3 min.**  **800 W**  
**6–7 min.**   **400 W**

Allow the mushrooms to stand for approximately 2 minutes once cooked.

# Meat, fish & poultry

Germany

## Courgette and macaroni bake

Total cooking time: approx. 41-49 minutes

Utensils: Bowl with lid (2 litre capacity)

Gratin dish (approx. 26cm diameter)

Ingredients

500 ml water  
1/2 tsp oil  
80 g macaroni  
400 g tinned tomatoes, chopped  
3 onions (150 g), finely chopped  
basil, thyme, salt & pepper  
1 tbsp oil to grease the dish  
450 g courgettes, sliced  
150 g sour cream  
2 eggs  
100 g grated cheddar cheese

1. Put the water, oil and salt in the dish and bring to the boil with the lid on.

**3-4 min.**  **800 W**

2. Break the macaroni into pieces, add to the dish, stir and allow to swell.

**8-10 min.**  **240 W**

Drain the macaroni and allow to cool.

3. Mix the tomatoes with the onions and season well.

Grease the gratin dish. Put the macaroni in it and pour the tomato sauce over it. Arrange the courgette slices on the top.

4. Beat the sour cream with the eggs and pour over the mixture in the dish. Sprinkle the grated cheese over the top.

**AUTOCOOK AC-8 or**

**25-28 min.**  **800 W**

**5-7 min.**   **400 W**

Allow the dish to stand for 5-10 minutes after cooking.

Austria

## Stuffed roast chicken

for two servings

Total cooking time: approx. 32-39 minutes

Utensils: Quiche dish

Thread

Ingredients

1 chicken (1000 g)  
salt, bruised (fresh) rosemary,  
bruised marjoram  
1 stale bread roll (40 g)  
salt  
1 bunch parsley, finely chopped (10 g)  
1 pinch nutmeg  
2 tbsp butter or margarine (20 g)  
1 egg yolk  
3 tbsp butter or margarine (30 g)  
1 tsp paprika, mild  
salt  
1 tsp butter or margarine to grease the dish

1. Wash the chicken, pat it dry and season the cavity with salt, rosemary and marjoram.

2. To make the filling, soak the bread roll for approximately 10 minutes in cold water, and then squeeze out excess water. Mix butter and egg yolk with salt, parsley, nutmeg, and stuff the chicken with the mixture. Sew the opening with cotton or butcher's thread.

3. Heat the butter.

**approx. 1 min.**  **800 W**

Mix the paprika and salt with the butter and smear it on the chicken.

4. Cook the chicken in the greased quiche dish (do not cover).

**1. 11-13 min.**  **800 W**

**2. 5-7 min.**   **400 W**

Turn the chicken over

**3. 11-13 min.**  **800 W**

**4. 4-5 min.**   **400 W**

Allow the stuffed chicken to stand for approximately 3 minutes after cooking.



# Meat, fish & poultry

Switzerland

## Fish fillet with cheese sauce





Total cooking time: approx. 22-26 minutes

Utensils: Bowl with lid (1 litre capacity)

Shallow round gratin dish  
(approx. 25 cm diameter)

Ingredients

3 fish fillets (approx. 600 g)  
2 tbsp lemon juice  
salt  
1 tbsp butter or margarine  
1 onion (50 g), finely chopped  
2 tbsp flour (20 g)  
100 ml white wine  
1 tsp vegetable oil to grease the dish  
100 g grated Emmental cheese  
2 tsp chopped parsley

1. Wash the fish, pat dry and sprinkle with lemon juice. Leave to stand for 15 minutes, pat dry again and rub with salt.
2. Smear the butter on the bottom of the dish. Add the diced onion, cover with the lid and steam.  
**approx. 2 min.**  **800 W**
3. Sprinkle the flour over the onions and stir. Add the white wine and mix.
4. Grease the gratin dish and place the fish in it. Pour the sauce over the fish and sprinkle with cheese. Place on the grill and cook.  
**16-19 min.**  **560 W**  
**4-5 min.**   **400 W**  
Allow fish to stand for approximately 2 minutes after cooking. Serve with a garnish of chopped parsley

Germany

## Grill skewers





Total cooking time: approx. 14-17 minutes

Utensils: Rack

3 wooden skewers  
(approx. 20-25 cm long)

Ingredients

250-300 g pork cutlets  
60 g bacon  
1-2 onions (75 g), cut in quarters  
3 tomatoes (150 g), cut in quarters  
1/2 green pepper (75 g), cut into 8  
3 tbsp oil  
2 tsp paprika  
salt  
1 tsp cayenne pepper  
1 tsp Worcester sauce

1. Cut the pork and the bacon into cubes approximately 2-3cm in size.
2. Skewer the meat the vegetables alternately on the wooden skewer.
3. Mix the oil with the spices and place the skewers on the rack and cook.  
**AUTOCOOK AC-2 or**  
**1. 7-9 min.**   **400 W**
4. Turn the skewers over.  
**2. 7-9 min.**   **400 W**

# Meat, fish & poultry

Spain

## Stuffed ham

Total cooking time: approx. 15-21 minutes

Utensils: Bowl with lid (2 litre capacity)

Shallow oval gratin dish with lid  
or microwave cling film  
(approx. 26 cm long)

Ingredients

125 g fresh spinach, with stalks removed  
125 g quark (6% fat)  
40 g grated Emmental cheese  
pepper  
paprika, mild  
6 slices cooked ham (300 g)  
125 ml water  
125 ml cream  
2 tbsp flour (20 g)  
2 tbsp butter or margarine (20 g)  
1 tsp butter or margarine to grease the dish

Tip: You can also use ready-made béchamel sauce for this recipe.

Greece

## Pot roast with green beans





Total cooking time: approx. 20-24 minutes



Utensils: Bowl with lid (2 litre capacity)

Ingredients

1-2 tomatoes (100 g)  
400 g lamb without bones  
1 tsp butter or margarine to grease the dish  
1 onion (50 g), finely chopped  
1 clove of garlic, crushed  
salt & pepper  
sugar  
250 g tinned green beans

Tip: If you use fresh beans, these must be cooked in advance.

1. Cut the spinach finely, mix with the quark and the cheese and season to taste.
2. Place a tablespoon of the filling on each slice of the cooked ham and roll up. Secure the ham with a wooden toothpick.
3. Make a béchamel sauce. To do this, pour the liquid into the dish, cover and heat.  
**3-4 min.**  **800 W**  
Rub the butter into the flour, add to the liquid and beat with a balloon whisk, until it is smooth. Cover, bring to the boil until thickened.  
**approx. 1 min.**  **800 W**  
Stir and taste.
4. Pour the sauce into the greased dish, place the ham rolls in the dish and cook with the lid on. To brown the top, remove the lid and place the dish on the rack.  
**1. 6-9 min.**  **800 W**  
**2. 5-7 min.**   **400 W**  
Allow the ham rolls to stand for approximately 5 minutes after cooking.

1. Peel the tomatoes, cut out the stalks and purée in a food processor.
2. Cut the lamb into large cubes. Grease the dish with butter. Add the meat, the diced onion and crushed garlic clove, season, cover dish and cook.  
**9-11 min.**  **800 W**
3. Add the beans and the puréed tomatoes to the meat and continue to cook with the lid on.  
**11-13 min.**  **560 W**  
Allow the meat to stand for approximately 5 minutes after cooking.

# Meat, fish & poultry

Switzerland



## Zurich veal stew

Total cooking time: approx. 11-15 minutes

Utensils: Bowl with lid (2 litre capacity)

Ingredients

600 g veal fillet  
1 tbsp butter or margarine  
1 onion (50 g), finely chopped  
100 ml white wine  
gravy thickener to make approx. 1/2 litre  
300 ml cream  
salt & pepper  
1 tbsp parsley, chopped

1. Slice the meat into finger-thick strips.
2. Smear the butter evenly around the dish. Add the onion and the meat to the dish, cover and cook. Stir once during cooking.  
**7-10 min.**  **800 W**
3. Add the white wine, the gravy powder and the cream, stir, cover and continue to cook. Stir once during cooking.  
**4-5 min.**  **800 W**
4. Taste the stew, stir again and allow to stand for 5 minutes. Serve with parsley garnish.

France

## Filet of sole

for 2 portions

Total cooking time: approx. 13-16 minutes

Utensils: Shallow oval gratin dish with lid (approx. 26 cm)

Ingredients

400 g filet of sole  
1 lemon, untreated  
2 tomatoes (150 g)  
1 tsp butter or margarine to grease the dish  
1 tbsp vegetable oil  
1 tbsp parsley, chopped  
salt & pepper  
4 tbsp white wine (30 ml)  
2 tbsp butter or margarine (20 g)

1. Wash the fish and pat dry. Remove any bones.
2. Slice the lemon and the tomatoes finely.
3. Grease the gratin dish with butter. Place the fish in it and drizzle with vegetable oil.
4. Sprinkle the fish with parsley, lay the slices of tomato on top and season. Lay the slices of lemon on top of the tomato and pour the white wine over this.
5. Dot the lemon with butter, cover and cook.  
**13-16 min.**  **560 W**  
Allow the fish fillet to stand for approximately 5 minutes after cooking.

Tip: You can also use rosefish, halibut, mullet, plaice or cod in this recipe.

# Meat, fish & poultry

China

## Prawns with chilli



Total cooking time: approx. 5 - 7 minutes

Utensils: Bowl with lid (1 litre capacity)

Bowl with lid (2 litre capacity)

Ingredients

6 prawns (shelled 240 g)  
50 ml white wine  
2 small bunches of chives (200 g)  
1-2 chillies, hot  
20 g ginger (fresh)  
1 tbsp cornflour  
2 tbsp vegetable oil (20 g)  
1½ tbsp soy sauce (20 ml)  
1 tbsp sugar  
1 tbsp vinegar

1. Wash the prawns. Remove the shell and tail. Cut into the spine and remove gut. Cut each prawn into 2 or 3 pieces and snip each piece so they do not curl when cooked. Put the prawns into a bowl and sprinkle with the wine. Cover and marinate.
2. Wash chives and chillies and pat dry. Cut chives into 5cm lengths. Cut chillies in half lengthwise and remove seeds. Peel and slice ginger.
3. Take the prawns out of the wine and coat them in cornflour.
4. Put oil, chives, chillies and ginger slices into bowl and cover. Heat.  
**approx. 2 min.**  **800 W**
5. Add prawns to the bowl. Season with soy sauce, sugar and vinegar. Stir and cook covered.  
**3-5 min.**  **800 W**  
Allow the prawns to stand for 1 - 2 minutes after cooking. Serve hot.

Germany

## Roast pork with crackling



Total cooking time: approx. 55-63 minutes

Utensils: Bowl with lid (2 litre capacity)

Bowl with lid (1 litre capacity)

Ingredients

1000 g boned shoulder of pork, with fat rind  
1 - 2 garlic cloves  
salt  
black pepper, freshly ground  
1 tsp caraway seeds  
2 carrots, sliced (125 g)  
60 g celeriac, finely diced  
60 g leeks, sliced in rings  
salt & pepper  
75 ml water  
75 ml beer  
dark gravy thickener for ¼-½ litre gravy

1. Wash the meat and pat dry. Cut a criss-cross pattern onto the fat rind.
2. Crush garlic clove, mix with salt, pepper and caraway seeds, and use to season meat.
3. Place the meat rind-down in bowl. Season vegetables and add them to bowl. Mix water and beer and pour into bowl. Cook covered, turning halfway through cooking.  
**1. 6-7 min.**  **800 W**  
**2. 46-52 min.**  **560 W**
4. Remove meat, wrap in kitchen foil and leave to stand for 10 minutes. Strain the meat juices through a sieve into the small dish. Add water to make 250 ml of liquid. Add the correct amount of gravy thickener to the juices, stir and heat covered, stirring occasionally.  
**3-4 min.**  **800 W**  
Season the sauce as required, pour over meat and serve.

Tip: Vegetables and dumplings or boiled potatoes go well with this recipe

# Vegetables & noodles

Italy

## Lasagne



Total cooking time: approx. 22-26 minutes

Utensils: Bowl with lid (2 litre capacity)

Shallow rectangular gratin dish with lid  
(approx. 20x20x6 cm)

### Ingredients

300 g tomatoes, tinned  
50 g ham, finely diced  
1 onion (50 g), finely chopped  
1 garlic clove, crushed  
250 g minced beef  
2 tbsp tomato puree (30 g)  
salt & pepper  
oregano, thyme, basil  
150 ml creme fraiche  
100 ml milk  
50 g grated Parmesan cheese  
1 tsp chopped mixed herbs  
1 tsp olive oil  
salt, pepper & nutmeg  
1 tsp vegetable oil for greasing dish  
125 g green lasagne sheets  
1 tsp grated Parmesan cheese  
1 tsp butter or margarine

1. Slice the tomatoes and mix with the diced onion and ham, garlic, minced beef and tomato puree. Season and steam with lid on.  
**7-9 min.**  **800 W**
2. Mix together the cream, milk, Parmesan cheese, herbs and oil. Season.
3. Grease the dish and cover the base with 1/3 of the pasta sheets. Spread half of the meat mixture on top of the pasta and cover with some of the cheese sauce. Lay another 1/3 of the pasta on top of this, followed by the meat mixture and some sauce. Finish with the last 1/3 of the pasta covered with a lot of sauce and top with grated Parmesan. Add butter slivers and cook with lid on.  
**15-17 min.**  **560 W**  
Leave the lasagne 5 to 10 minutes to stand after cooking.

France

## Vegetable casserole

Total cooking time: approx. 19-21 minutes

Utensils: Bowl with lid (2 litre capacity)

### Ingredients

5 tbsp olive oil (50 ml)  
1 garlic clove, crushed  
1 onion (50 g), sliced  
1 small aubergine (250 g), roughly chopped  
1 courgette (200 g), roughly chopped  
1 pepper (200 g), roughly chopped  
1 small fennel bulb (75 g), roughly chopped  
pepper  
1 bouquet garni  
200 g tin artichoke hearts, quartered  
salt & pepper

1. Put olive oil and garlic in dish. Add all the prepared vegetables except the artichoke hearts and season with pepper. Add the bouquet garni and cook covered. Stir once during cooking.  
**19-21 min.**  **800 W**  
Add the artichoke hearts to the bowl for the last 5 minutes.
2. Season the ratatouille to taste and take the bouquet garni out before serving. Once cooked, leave the ratatouille to stand for about 2 minutes.

Tips: Serve this hot vegetable casserole with meat dishes.  
Served cold it makes a delicious starter.

A bouquet garni is made of:  
a sprig of parsley, lovage, thyme and a few bay leaves.

# Vegetables & noodles

Spain

## Stuffed potatoes



Total cooking time: approx. 12 - 16 minutes

Utensils: Bowl with lid (2 litre capacity)

China plates

Ingredients

- 4 medium-sized potatoes (400 g)
- 100 ml water
- 60g ham, finely diced
- 1/2 onion (25 g), finely chopped
- 75-100 ml milk
- 2 tbsp grated Parmesan cheese (20 g)  
salt & pepper
- 2 tbsp grated Emmental cheese

1. Put the potatoes in the bowl, add the water, cover and cook. Turn once during cooking.  
**8-10 min.**  **800 W**  
Allow to cool.
2. Halve the potatoes lengthways and carefully scoop out the flesh. Mix the potato with the ham, onion, milk and Parmesan until it is smooth. Season with salt and pepper.
3. Fill the potato skins with the mixture, top with the grated Emmental, place on the plates and cook.  
**4-6 min.**  **800 W**  
Leave the potatoes to stand for about 2 minutes after cooking.

# Drinks & desserts

Denmark



## Berry jelly with vanilla sauce

Total cooking time: approx. 10-13 minutes

Utensils: 2 dishes with lids (2 litre capacity)

Ingredients

- 150 g redcurrants, washed, stems and stalks removed
- 150 g strawberries, washed, stalks removed
- 150 g raspberries, washed and checked
- 250 ml white wine
- 100 g sugar
- 50 ml lemon juice
- 8 gelatine sheets
- 300 ml milk  
flavouring from 1/2 vanilla pod
- 30 g sugar
- 15 g cornflour

1. Reserve some of the fruit for decoration. Puree the rest of the berries with the wine. Put into the bowl and cook cover.  
**7-9 min.**  **800 W**  
Add sugar and lemon juice.
2. Leave gelatine in cold water for 10 minutes to soften. Remove and squeeze out water. Stir gelatine into the hot fruit until it dissolves. Put the jelly into the fridge to set.
3. To make the vanilla sauce, put the milk in a bowl. Slice the vanilla pod open and scrape out the vanilla flavouring. Stir the flavouring, sugar and cornflour into the milk and cover before cooking. Stir occasionally during cooking and to finish.  
**3-4 min.**  **800 W**
4. Tip the set jelly onto a plate and garnish with the whole berries. Serve with the vanilla sauce.

Tip: You can also use frozen fruit once it is defrosted.

Deutschland

## Hot lemon

for 1 portion

Total cooking time: approx. 1-2 minutes

Utensils: Tea glass (150 ml capacity)

Ingredients

- 100 ml water  
juice of 1 lemon
- 2-3 tsp sugar

1. Pour water and lemon juice into the glass and heat.  
**approx. 1-2 min.**  **800 W**  
Stir in sugar to taste.

# Drinks & desserts

France

## Pears in chocolate sauce



Total cooking time: approx. 12-16 minutes

Utensils: Bowl with lid (2 litre capacity)

Bowl with lid (1 litre capacity)

Ingredients

4 pears (600 g)  
60 g sugar  
1 packet of vanilla sugar (10 g)  
1 tbsp pear liqueur, 30% proof  
150 ml water  
130 g plain chocolate, broken into pieces  
100 g crème fraîche

1. Peel the pears, keeping them whole.
2. Put sugar, vanilla sugar, liqueur and water into the bowl. Stir and heat.  
**1-2 min.**  **800 W**
3. Place the pears in the juice, cover and cook.  
**9-11 min.**  **800 W**  
Take the pears out of the juice and allow to cool.
4. Put 50 ml of the juice in the small bowl, add the cream and chocolate. Cover and heat.  
**2-3 min.**  **800 W**
5. Stir the sauce well and pour over the pears to serve.

Tip: You could also serve this with vanilla ice cream.

Niederlande

## Fiery drink

for 10 portions

Total cooking time: approx. 9-11 minutes

Utensils: Bowl with lid (2 litre capacity)

Ingredients

500 ml white wine  
500 ml red wine, dry  
500 ml rum, 54% proof  
1 whole orange, untreated  
3 cinnamon sticks  
75 g sugar  
10 tsp rock candy

1. Pour the alcohol into the bowl. Peel the orange so that the peel is thin and put this in the alcohol together with the cinnamon and sugar. Cover and heat.  
**9-11 min.**  **800 W**  
Remove the peel and cinnamon. Put one teaspoon of the rock candy into each grog glass, top up with the fiery drink and serve.

Österreich

## Chocolate with cream

for 1 portion

Total cooking time: approx. 1-2 minutes

Utensils: Large cup (200 ml capacity)

Ingredients

150 ml milk  
30 g plain chocolate, grated  
30 ml cream  
chocolate vermicelli

1. Pour the milk into the cup. Add the chocolate, stir and heat. Stir occasionally.  
**approx. 1-2 min.**  **800 W**
2. Whip the cream until stiff and spoon this on top of the chocolate. Serve garnished with chocolate vermicelli.

## Care & cleaning

**CAUTION: DO NOT USE COMMERCIAL OVEN CLEANERS, STEAM CLEANERS, ABRASIVE, HARSH CLEANERS, ANY THAT CONTAIN SODIUM HYDROXIDE OR SCOURING PADS ON ANY PART OF YOUR MICROWAVE OVEN.**

### **Oven exterior**

The outside of your oven can be cleaned easily with mild soap and water. Make sure the soap is wiped off with a moist cloth, and dry the exterior with a soft towel.

### **Oven controls**

Open the door before cleaning to de-activate the oven controls. Care should be taken when cleaning the oven control. Using a cloth dampened with water only, gently wipe the panel until it becomes clean. Avoid using excessive amounts of water. Do not use any sort of chemical or abrasive cleaner.

### **Oven Interior**

1. For cleaning, wipe any splatters or spills with a soft damp cloth or sponge after each use while the oven is still warm. For heavier spills, use a mild soap and wipe several times with a damp cloth until all residues are removed. Do not remove the waveguide cover.
2. Make sure that mild soap or water does not penetrate the small vents in the walls which may cause damage to the oven.
3. Do not use spray type cleaners on the oven interior.
4. Heat up your oven regularly by using the grill, refer to note 2 on page 15. Remaining food or fat splashed can cause smoke or a bad smell.

### **Turntable and turntable support**

Remove the turntable and turntable support from the oven. Wash the turntable and turntable support in mild soapy water. Dry with a soft cloth. Both the turntable and the turntable support are dishwasher safe.

### **Door**

To remove all trace of dirt, regularly clean both sides of the door, the door seals and sealing surfaces with a soft, damp cloth.

### **Rack**

This should be washed in a mild washing up liquid solution and dried. The rack is dishwasher safe.

**NOTE:** A steam cleaner should not be used.



# What to do if...



## ... the microwave appliance is not working properly ?

Check that

- the fuses in the fuse box are working,
- there has not been a power outage.
- If the fuses continue to blow, please contact a qualified electrician.



## ... the microwave mode is not working ?

Check that

- the door is properly closed,
- the door seals and their surfaces are clean,
- the START-button has been pressed



## ... the turntable is not turning ?

Check that

- the turntable support is correctly connected to the drive,
- the ovenware does not extend beyond the turntable,
- food does not extend beyond the edge of the turntable preventing it from rotating.
- there is nothing in the well beneath the turntable.



## ... the microwave will not switch off ?

- Isolate the appliance from the fuse box.
- Contact your local Service Force Centre.



## ... the interior light is not working ?

- Call your local Service Force Centre. The interior light bulb can be exchanged only by trained Service Force technicians.



## ... the food is taking longer to heat through and cook than before ?

- Set a longer cooking time (double quantity = nearly double time) or
- if the food is colder than usual, rotate or turn from time to time or
- set a higher power setting.

**NOTE:** If you cook the food over the standard time with only the same cooking mode, the power of the oven will lower automatically to avoid overheating. (The microwave power level will be reduced or the grill heating element will begin to light on and off). After pausing for 90 seconds, full power can be reset

Cooking Mode	Standard time	Reduced power level
Microwave (800 W)	20 minutes	Microwave - 560 W
Grill	10 minutes	Grill - 50 %
Dual Grill	Grill - 10 minutes	Grill - 50 %

# Service & spare parts

If you wish to purchase spare parts or require an engineer, contact your local AEG Service Force Centre by telephoning:

**08705 929 929**

Your telephone call will be automatically routed to the Service Force Centre covering your post code area.

For the address of your local Service Force Centre and further information about Service Force, please visit the website at:

**[www.serviceforce.co.uk](http://www.serviceforce.co.uk)**

When you contact the Service Force Centre they will need the following information:

1. Your name & address, including post code.
2. Your telephone number
3. Clear and concise details of the fault.
4. The model and serial number of the appliance (found on the rating plate).
5. The purchase date:  
Please note that a valid purchase receipt or guarantee documentation is required for in-guarantee service calls.

## Customer care

For general enquiries concerning your AEG appliance or for further information on AEG products please contact our Customer Care Department by letter or telephone at the address below or visit our website at:

**[www.aeg.co.uk](http://www.aeg.co.uk)**

Customer Care Department  
AEG Domestic Appliances  
55-77 High Street  
Slough  
Berkshire, SL1 1DZ

Tel. 08705 350350 (\*)

(\*) Calls may be recorded for training purposes.

For Customer Service in Ireland please contact us at the address below:

AEG  
Electrolux Group (Irl) Ltd  
Long Mile Road  
Dublin 12  
Republic of Ireland

Tel: + 353 (0)1 4090754

Email: [service.eid@electrolux.ie](mailto:service.eid@electrolux.ie)

# Guarantee conditions

## Standard guarantee conditions

We, AEG, undertake that if within 12 months of the date of the purchase this AEG appliance or any part thereof is proved to be defective by reason only of faulty workmanship or materials, we will, at our discretion repair or replace the same FREE OF CHARGE for labour, materials or carriage on condition that:

- The appliance has been correctly installed and used only on the electricity or gas supply stated on the rating plate.
- The appliance has been used for normal domestic purposes only, and in accordance with the manufacturer's operating and maintenance instructions.
- The appliance has not been serviced, maintained, repaired, taken apart or tampered with by any person not authorised by us.
- All service work under this guarantee must be undertaken by a Service Force Centre. Any appliance or defective part replaced shall become the Company's property.
- This guarantee is in addition to your statutory and other legal rights.
- Home visits are made between 8.30am and 5.30pm Monday to Friday.  
Visits may be available outside these hours in which case a premium will be charged.

## Exclusions

This guarantee does not cover:

- Damage or calls resulting from transportation, improper use or neglect, the replacement of any light bulbs or removable parts of glass or plastic.
- Costs incurred for calls to put right an appliance which is improperly installed or calls to appliances outside the United Kingdom.
- Appliances found to be in use within a commercial environment, plus those which are subject to rental agreements.
- Products of AEG manufacture which are not marketed by AEG.

## European Guarantee

If you should move to another country within Europe then your guarantee moves with you to your new home subject to the following qualifications:

- The guarantee starts from the date you first purchased your product.
- The guarantee is for the same period and to the same extent for labour and parts as exists in the new country of use for this brand or range of products.
- This guarantee relates to you and cannot be transferred to another user.
- Your new home is within the European Community (EC) or European Free Trade Area.
- The product is installed and used in accordance with our instructions and is only used domestically, i.e. a normal household.
- The product is installed taking into account regulations in your new country.

Before you move please contact your nearest Customer Care centre, listed below, to give them details of your new home. They will then ensure that the local Service Organisation is aware of your move and able to look after you and your appliances.

France	Senlis	+33 (0) 3 44 62 29 29
Germany	Nürnberg	+49 (0) 800 234 7378
Italy	Pordenone	+39 (0) 800 117511
Sweden	Stockholm	+46 (0) 8 672 5360
UK	Slough	+44 (0) 1753 219899

# Specifications

AC Line Voltage	: 230-240 V, 50 Hz, single phase
Distribution line fuse/circuit breaker	: Minimum 16 A
AC Power required:	Microwave : 1.25 kW Grill : 1.00 kW Dual grill : 2.2 kW
Output power:	Microwave : 800 W (IEC 60705) Grill : 1000 W
Microwave Frequency:	: 2450 MHz
Outside Dimensions:	MCD1751E : 492 mm (W) x 370 mm (H) x 316 mm (D) MCD1761E : 592 mm (W) x 370 mm (H) x 316 mm (D)
Cavity Dimensions	: 285 mm (W) x 202 mm (H) x 298 mm (D) *
Oven Capacity	: 17 litres *
Turntable	: ø 272 mm, glass
Weight	: approx. 16 kg
Oven lamp	: 25 W/240 - 250 V

\* Internal capacity is calculated by measuring maximum width, depth and height.  
Actual capacity for holding food is less.



This oven complies with the requirements of Directives 89/336/EEC and 73/23/EEC as amended by 93/68/EEC.

SPECIFICATIONS ARE SUBJECT TO CHANGE WITHOUT NOTICE AS PART OF CONTINUOUS IMPROVEMENT

## Important information



### Ecologically responsible disposal of packaging materials and old appliances



#### Packaging materials

AEG microwave ovens require effective packaging to protect them during transportation.

Only the minimum packaging necessary is used.

Packaging materials (e.g. foil or styrofoam) can place children at risk.



**Danger of suffocation. Keep packaging material away from children.**



All packaging materials used are environment friendly and can be recycled. The cardboard is made from recycled paper and the wooden parts are untreated. Plastic items are marked as follows:

«PE» polyethylene eg packaging film

«PS» polystyrene eg packaging (CFC-free)

«PP» polypropylene eg packaging straps

By using and re-using the packaging, raw materials are saved and waste volume is reduced.

Packaging should be taken to your nearest recycling centre.

Contact your local council for information.



#### Disposal of old appliances

Old appliances should be made safe before disposal by removing the plug, and cutting off and disposing of the power cable.

It should then be taken to the nearest recycling centre. Check with your local Council or

Environmental Health Office to see if there are facilities in your area for recycling the appliance.

# **i** Installation

## INSTALLING THE APPLIANCE

1. Remove all packaging and check carefully for any signs of damage.
2. If fitting the microwave oven above a conventional oven (position A) then use the mylar sheet provided.
  - a. Cut the Mylar sheet to fit the internal width of the unit.
  - b. Peel back the protective cover on the tape and fix to the rear of the shelf so that it covers the service gap. (See diagram).

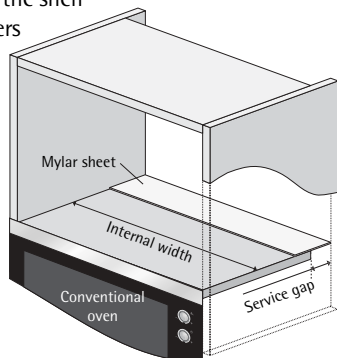

3. Fit the appliance into the kitchen cupboard slowly, and without force, until the front frame of the oven seals against the front opening of the cupboard.

4. Ensure the appliance is stable and not leaning. Ensure that a 5mm gap is kept between the cupboard door above and the top of the frame (see diagram).



5. Fix the oven in position with the screws provided.

The fixing points are located on the top and bottom corners of the oven (see diagram, item 10, on page 5).

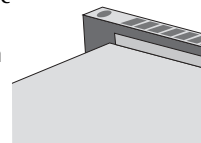

6. It is important to ensure that the installation of this product conforms to the instructions in this operation manual and the hob or conventional oven manufacturer's installation instructions.

## SAFE USE OF THE APPLIANCE

If fitting the microwave in position B or C:

- The cupboard must be a minimum of 500mm (E) above the worktop & must **not** be installed **directly** above a hob.
- This appliance has been tested and approved for use near domestic gas, electric and induction hobs only.
- Sufficient space between hob and microwave should be allowed to prevent overheating of microwave oven, surrounding cupboard and accessories.
- Do not operate the hob without pans when the microwave oven is operating.
- Care should be taken when attending to the microwave oven while the hob is on.

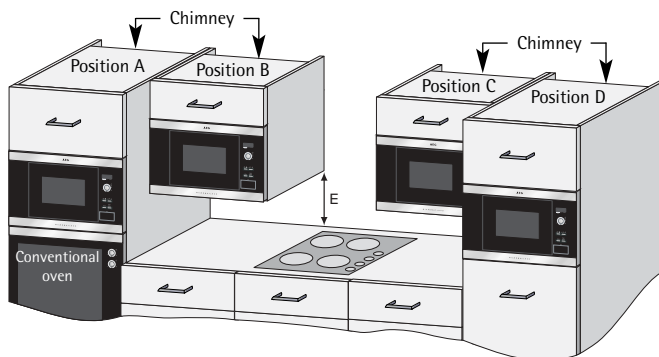

POSITION	NICHE SIZE			CHIMNEY (min)	Gap Between Cupboard & Ceiling
	W	D	H		
A	560 x	550 x	360	50	50
B + C	460 x	300 x	360	18	50
	560 x	300 x	360	18	50
D	460 x	500 x	360	40	50
	560 x	500 x	360	40	50

Measurements in (mm)

# **i** Installation

## CONNECTING THE APPLIANCE TO THE POWER SUPPLY

- The electrical outlet should be readily accessible so that the unit can be unplugged easily in an emergency.
- The socket should not be positioned behind the cupboard.
- The best position is above the cupboard, see (A).  
When not connecting the power supply cord to position (A) it should be removed from the support clip (see diagram, item 14, on page 5) and routed under the oven.
- Connect the appliance to a single phase 230-240V/50Hz alternating current via a correctly installed earth socket. The socket must be fused with a  $\geq 16A$  fuse.
- If the appliance is to be operated in a non-European country, the supply voltage, current type and frequency of the appliance indicated on the rating plate must correspond with the specification of your power supply. The rating plate can be found on the inside face of the control panel.
- The power supply cord may only be replaced by an electrician.
- Before installing, tie a piece of string to the power supply cord to facilitate connection to point (A) when the appliance is being installed.
- When inserting the appliance into the high-sided cupboard, DO NOT crush the power supply cord.

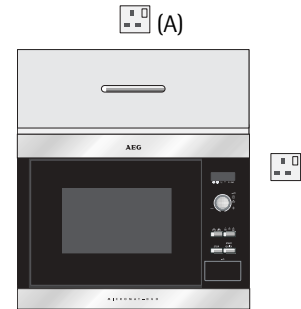

## ELECTRICAL CONNECTIONS



**WARNING:**  
**THIS APPLIANCE MUST BE EARTHED**  
The manufacturer declines any liability should this safety measure not be observed.

- If the plug that is fitted to your appliance is not suitable for your socket outlet, it must be cut off and the appropriate plug fitted.
- Remove the fuse from the cut off plug. The cut off plug should then be disposed of to prevent the hazard of shocks in case it should be plugged into a 13 Amp socket in another part of your home.

### IMPORTANT

The wires in the mains lead are coloured in accordance with the following code:

GREEN AND YELLOW	EARTH
BLUE	NEUTRAL
BROWN	LIVE

If you fit your own plug, the colours of the wires in the mains lead of your appliance may not correspond with the markings identifying the terminals in your plug, proceed as follows:

- Connect the green and yellow (earth) wire to the terminal in the plug which is marked with the letter "E" or the earth symbol ( $\perp$ ) or coloured green and yellow.
- Connect the blue (neutral) wire to the terminal in the plug which is marked with the letter "N" or coloured black.
- Connect the brown (live) wire to the terminal in the plug which is marked with the letter "L" or coloured red.

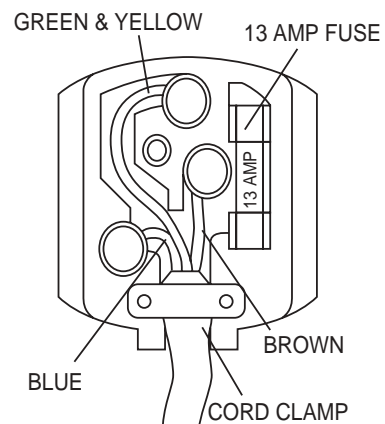





**From the Electrolux Group. The World's No.1 choice.**

*The Electrolux group is the world's largest producer of powered appliances for the kitchen, cleaning and outdoor use. More than 55 million Electrolux Group products (such as refrigerators, cookers, washing machines, vacuum cleaners, chain saws and lawn mowers) are sold each year to a value of approx. USD 14 billion in more than 150 countries around the world.*

AEG Domestic Appliances  
Cornwall House  
55 - 77 High Street  
SLOUGH  
SL1 1DZ

Telephone: 08705 350350

© Electrolux plc 2004

TINS-A350URR0 △

Printed on recycled paper-  
AEG - putting words into action

Printed on paper manufactured with  
environmentally sound processes.  
He who thinks ecologically acts accordingly ...