

MICROMAT DUO 21

Microwave Oven

Operating Instructions

Contents

Safety Instructions for the user	3/4
Golden rules for using your microwave oven	3/4
Practical Hints	5
Hints on setting power	6
Practical hints on working with microwave appliances	7
The Correct Ovenware	8
Features	9
Installing the Tabletop Model	10
Operation	10
Cooking Charts	11
Heating of refrigerated food and drinks	11
Defrosting	11/12
Roasting of meat, poultry and game	12
Cooking of vegetables and potatoes	13
Roasting/Grilling	13
Grilling	13
Cleaning and Care	14
Cleaning the appliance	14
If You Think Your Microwave is Not Functioning Properly	14
Technical Data	15/16

Safety instructions

Please read these operating instructions thoroughly before using the microwave oven. You will learn how to operate the oven, how to set cooking time and power and how to clean and maintain it.

Golden rules for trouble-free and safe working of your microwave oven

1. Switch on the microwave only when food has been placed inside the oven.
2. Always keep the microwave oven clean, especially in the vicinity of the door seals and door seal surfaces.
3. **Never damage:**
 - the door
 - the door hinges
 - the door seals and their surfaces
 - the door frame

(e. g. never jam anything between the door and frame).

Clean the door seals and their surfaces (also the door frame) with a mild detergent i. e. washing up liquid.

Note:

Should the door seals or door seal surfaces be damaged the microwave oven should not be operated until these have been repaired by the AEG Service Centre or by an AEG Service Agent.

4. **Only use suitable ovenware.**
5. When heating liquids place a teaspoon in the container to avoid delayed boiling.
During delayed boiling, the boiling temperature is attained without typical steam bubbles rising. Even when the container is only slightly shaken, the liquid may then suddenly vigorously boil over or spurt with a risk of scalding.
6. Food with a "skin" or "peel" such as potatoes, tomatoes, sausages etc, should be pierced with a fork so that any steam present can escape and the food will not burst.
7. Make sure that a minimum temperature of 70 °C is attained for the cooking/heating of food. This will be achieved if you follow the instructions given in the cooking tables (time/power). Do not use mercury or liquid thermometers to measure the food temperature.
8. Babyfood in jars or bottles should be heated without a lid or top and well stirred or shaken after heating to ensure uniform distribution of the heat. Before giving your child the babyfood, please check the temperature.
9. Please note that when selecting a high power combined with a long time, the ovenware can heat up.
Therefore always use protective gloves suitable for handling hot pans.

Before you read on

Safety instructions for the user

Safety Instructions for the user

10. **Do not leave the appliance unattended when heating food in plastic, paper or other containers made of inflammable materials. If you notice smoke, leave the appliance door closed, switch off the appliance and disconnect from the power supply.**
11. **Never use your microwave oven:**
 - **to boil eggs in their shells, they will burst!**
 - **to heat large quantities of cooking oil (fondue, deep-frying) and drinks containing a high percentage of alcohol (there is a danger of spontaneous combustion!)**
 - **to heat unopened cans, bottles, etc.**
 - **to dry animals, textiles, and paper**
 - **without food being placed in the oven**
 - **with crockery (porcelain, ceramics, earthenware, etc.) which have voids that fill with water and which may cause vapour pressures to build up during cooking. Please follow the respective manufacturer's instructions.**
12. **Use your appliance only as instructed** and as indicated in the "Cooking tables". Never overcook your food by excessive times and power settings. Specific areas of the food will dry out and may ignite.
13. If the appliance lead is damaged it must be changed for one of the same type by an AEG Engineer or an AEG authorised service agent.
14. **Only operate your appliance when the turntable is inserted.**
15. **The microwave oven door will get hot when used in the combination mode or when grilling, so keep small children well away from the appliance.**
16. **If the viewing window is hot, please close the door by pressing the trapezium-shaped plate on the lower right-hand side of the door.**

AEG electrical appliances comply with all the valid safety requirements. Never use your microwave oven if it no longer operates in a trouble-free manner.

To ensure the safety of your appliance, you should have repairs, especially on live parts, carried out only by AEG Service or AEG trained Service Agents. In the event of a fault, you should contact your retailer or our service centre direct. Improper repairs may place the user at serious risk. The interior light should only be changed by an AEG Service Engineer or AEG trained Service Agent.

Practical hints

To familiarise easily and quickly with the operation of the microwave oven, please use the "Cooking Tables" section.

Cooking time depends on the quantity of food. As a guide:

Double Quantity = Almost Double Time.

Initially always select the shorter cooking time. Only when necessary extend the time as required.

Food comes in different qualities and is prepared in different quantities, therefore the times and amounts of energy necessary for **defrosting, heating or cooking** are different.

The "cooking tables" will give you practical samples.

The standing time referred to in the "Cooking tables" means:

Allow the food to stand **without** power i. e. inside or outside the appliance, to ensure that the heat in the food is uniformly distributed.

**How to cook
by time
and power**

**General hints
on cooking,
heating,
and
defrosting**

**Standing
time**

Hints on power settings

The following list will give you recommended power settings for the different types of food.

Setting 8–9 Maximum power

- to start a cooking sequence i. e. **bring to the boil, start roasting, stewing, etc.**
- **roasting meat on a browning skillet**
- **heating ready-made meals/convenience foods**
- **defrosting and heating of frozen ready-made meals**

Setting 6–7

- **warming** delicate dishes such as mushrooms, cheese, snails, mussels, beaten eggs, kidney beans, butter, baby-food in glass jars, chocolate for coating cakes
- **starting to stew** cubed meat (goulash)
- cooking fish

Setting 3–5

- **simmering** soups, stews, casseroles, noodles (after bringing to the boil on Setting 9)

Setting 2–3

- **defrosting** meat, fish, fruit, bread and cakes
- **soaking** rice and making milk puddings (after bringing to the boil on Setting 9)

Setting 1–2

- **warming** cold dishes and drinks, softening butter
- **defrosting** dishes with a high fat content i. e. sausage and cheese
- proving yeast dough
- defrosting cream and butter
- defrosting cakes with cream or butter icing.

Practical hints on working with microwave appliances

Practical hints on working with microwave appliances

Wherever possible, cook in a covered container. Only if crust is required or is to be retained should you cook food in uncovered containers. After switching off your appliance, allow the food to stand inside for some minutes (**standing time**).

Refrigerated or frozen foods require a longer cooking time.

Foods containing sauces should be stirred from time to time.

Vegetables:

Cook vegetables with firm consistency, such as carrots, peas, and cauliflower, with a little water. Cook vegetables with soft consistency, such as mushrooms, peppers, and tomatoes, without liquid.

Meat:

Place frozen, unpacked meat on an inverted plate in a glass or porcelain container so that the meat juice can drain. Turn during the defrosting period.

When the defrosting period has elapsed, the pieces of meat need a differently long **standing time** depending on consistency.

Butter, pieces of layer cake, cottage cheese:

Previously remove aluminium foil packaging. Do not fully defrost in the appliance, but leave to adjust outside.

Ready meals in metal packages or plastic containers with metal lids should be heated or defrosted in your microwave oven **only if they are explicitly marked as being suitable for microwave use.**

Please follow the operating instructions printed on the packages (remove the metal lid and prick the plastic foil).

Important: Metal objects must be placed at least 2 cm away from the cooking space walls and door.

Cooking:

Defrosting

Ready meals

The correct ovenware





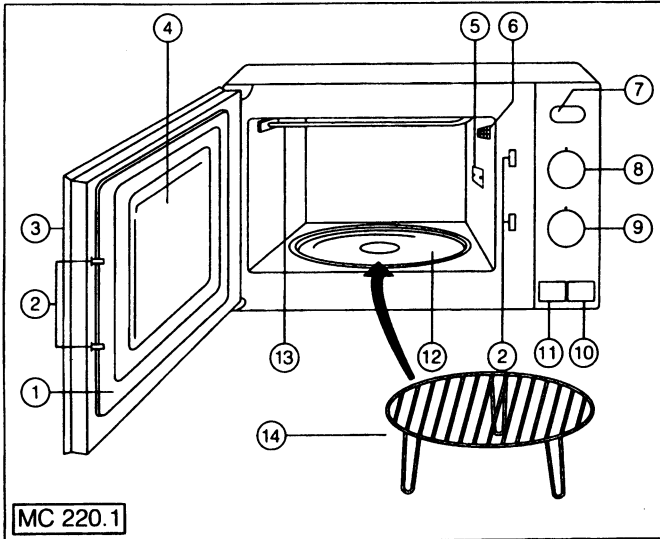

The correct ovenware

Crockery material	Operating modes			
	De-frosting	Heating	Cooking	Combined operation microwave + grill
Glass ¹⁾ (heat proof)	X	X	X	X
Glass ceramic	X	X	X	X
Porcelain ¹⁾ (heat proof)	X	X	X	X
Earthenware ¹⁾	X	X	X	X
Plasticware ²⁾	X	X	X	-
Paper cups	X	-	-	-
Paper plates	X	-	-	-
Grease-proof paper ⁴⁾	X	X	-	-
Board ⁴⁾	X	X	-	-
Aluminium foil ³⁾	X	X	X	-
Shallow foil containers (for convenience foods)	X	X	X	X
Metal objects	-	-	-	-
Crockery with metal base	-	-	-	-
Clingfilm non PVC	X	-	-	-
Roasting bags	X	X	X	-

- 1) Without silver, gold, platinum, or metal parts**
2) Please note the relevant manufacturer's instructions
3) Please follow the instructions given under "Practical hints"
4) With prolonged heating there is a risk of fire!

Features



- 1 Door seal
- 2 Door safety catch
- 3 Door
- 4 Viewing window
- 5 Microwave guide cover
- 6 Interior light
- 7 Function selector for grill 
 -  Grill | ON = button in
 -  Grill ○ OFF = button out
- 8 Power setting for microwave 
- 9 Timer 
- 10 Start button 
- 11 Door opener 
- 12 Turntable (rotates left or right)
- 13 Grill heating element
- 14 Grill rack

















Features

Installing the tabletop model

To ensure trouble-free ventilation, an air space of 5 cm around the appliance is necessary.

Connect to a plug socket with protective earth contact and fused with a 16 A-L automatic device or 16 A slow-blowing fuse!

Operation

- Microwave cooking** Open the door by pressing the **Door Open** button . Place food on turntable and close door.
- Power** Set the microwave power level  to the required setting. The **Grill Function** button  must be in the "OFF" position (the button is in the "out" position .
- Combination cooking** Open the door using the **Door Open** button . Place food onto either turntable or wire shelf and close the door. Set microwave  setting to the required level and press the **Grill** button  (Grill on = button "in" .
- Grilling** Open the door using the **Door Open** button . Place food onto either turntable or wire shelf and close the door. Press **Grill** button  (Grill on = button "in" ). Set the microwave power level  to "0".
- Cooking time** Set the cooking time using the timer knob . If the cooking time is less than two minutes then first turn the dial to "**Less than 10 minutes**" and only then set the required cooking time.
- Start** Press **Start** button . At the end of the cooking time an audible signal will be heard and the machine turns itself off automatically.
- Interrupting the cooking time** The microwave operation can be interrupted by opening the door using the **Door Open** button . The time and power setting remain unaltered. Close the microwave oven's door and press the **Start** button . The remaining cooking times continues automatically.

Heating of refrigerated food and drinks

Type/quantity	Remarks/hints	Power ▲	Time/ minutes
Food			
1 jar baby food (125–250 ml)	Heat jar without lid, stir after warming	5–6	1/2–2
1 convenience meal on a plate (350–400 g)	Heat in covered container. Place gravy alongside separately in cup	9	2–3
Drinks*			
200 ml milk or baby food	Stir after warming	7–8	1/2–1
1 cup coffee (130 cc)		9	1–2

* additionally place teaspoon in container

Defrosting

Type/quantity	Remarks/hints	Power ▲	Time/ minutes	Standing time/ minutes
Meat				
Whole joint (1000 g)	Turn once. Cover fatty parts with alu- minium foil after 1st half of defrosting time.	2–3	25–30	10–15
Steaks (per 200 g)	Turn once	2–3	3–4 1/2	5–10
Mince (500 g)	remove defrosted meat after 10 minutes	2	14–20	10–15
(250 g)		2	8–10	10–15
Poultry				
Chicken (around 1 kg)	Turn once. Cover legs with aluminium foil after 1st half of de- frosting time.	2–3	20–25	10–20
Fish				
Whole fish (about 500 g)	Turn once. Possibly cover fins with aluminium foil	1–2 ✳	10–12	15–20
Fruit				
Strawberries, damsons, cherries, redcurrants, apricots etc (500 g)	Allow to defrost in a cov- ered container. During de- frost time in oven stir once	1–2 ✳	8–10	10–15
Raspberries	see above	1–2 ✳	4–6	10–15

Defrosting

Type/quantity	Remarks/hints	Power ▲	Time/ minutes	Standing time (minutes)
Bread				
4 bread rolls (each about 50 g)		3	2	5-7
1 bread roll		3	1	3-5
Cakes				
Dry cakes, eg shortcrust pastry cakes (around 300 g)	Allow cakes to defrost uncovered on a serviette or plate	1-2 ✳	3-4	5-10
Cream and buttercream sandwich cakes (300-400 g)	Only start defrosting of cakes in the microwave	1	5-6	30-60

Roasting of meat, poultry and game

Type/quantity	Remarks/hints	Power ▲	Time/ minutes
Shoulder of pork (per 750 g)	Turn after 1st setting	1. 9 2. 6-7	6-8 25-30
Cutlet	see above	1. 9 2. 6-7	5-6 12-14
Meat Loaf (with 500 g meat)	cook in uncovered container	9	15-18
Boiled chicken portions (per 1000 g)	Cook in covered container without liquid	9	10-12
Fish fillets (500 g)	Cover during cooking	9	7-9

Cooking of vegetables and potatoes

Type	Quantity	Liquid addition	Remarks/hints	Power ▲	Time/ minutes
Frozen broccoli	300 g	1/8 l	Stalks facing outwards	9	10-12
Mushrooms	250 g	none	Cut into slices	9	4-5
Carrots	250 g	1/2 cup	Cut into cubes or slices	9	8-10
Potatoes	250 g	2-3 Tblsp		9	4-5

Roasting/Grilling

Type	Quantity	Cooking surface	First phase (Microwave) Power level/ Time (mins)	Second phase (Grill) (mins)	Comments
Meat:					
Mince	1000 g	tripod	9 15-17	7-10	
Meatloaf	500 g	tripod	9 5-7	7-10	
Poultry:					
Chicken, whole	1000 g	turntable	9 12-15	15-25	Cover during first phase. Turn once during grilling
2 chicken breasts	750 g	turntable	9 10-12	7-10	
3 drumsticks	600 g	tripod	9 7-8	10-12	
Fish:					
Whole fish	500 g	tripod	9 5-7	10-14	Cover during first phase
Frozen fish	400 g	tripod	8 8-10	15-20	
Baked fish	750 g	tripod	9 10-12	5-7	
Gratins:					
Potato gratin	750 g	turntable	9 12-15	10-15	Cover during first phase
Pasta bake	1000 g	turntable	9 7-10	5-7	
Baked vegetables	750 g	tripod	9 10-12	7-10	
Frozen Lasagne	400 g	tripod	8 11-13	7-10	
Cottage Cheese	750 g	turntable	9 12-15	5-7	
Rice Pudding	750 g	turntable	8 10-12	5-7	

Grilling

Type	Quantity	Cooking surface	First side mins.	Second side mins.	
Toast	1	tripod	10-12		
Hamburger	1	tripod	15-18	12-15	

Cleaning and care

Cleaning the appliance

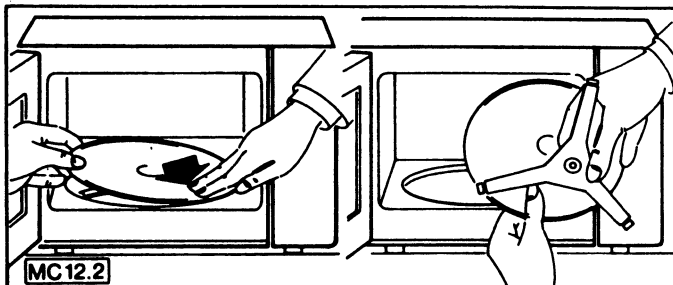

Cleaning should only be carried out when the appliance is unplugged from the mains supply.
Use only mild cleaners and hot water.
Clean your appliance inside and outside with a soft cloth. Never use abrasive scouring agents.
You can neutralize odours inside the cooking space by boiling a cup of water with a little lemon juice for a few minutes in your appliance.

If you think your microwave oven is not functioning properly

Before calling the service centre, please check whether, on the basis of the following hints, you can rectify the fault yourself.
If your microwave oven no longer works, check whether:

- your appliance is plugged into the mains supply;
- the fuses in the fixed wiring are in order;
- the door is fully closed;
- the start button is pressed.

If, after these checks, your microwave oven still does not work, please call the AEG service centre or your retailer.

If after you have made these checks the microwave oven still does not work, please telephone AEG Customer Service.

- If you decide to call the Service Centre to help with any of the above instructions or on grounds of faulty operation, the service engineer's visit cannot be made free of charge even during the guarantee period.
- Therefore please take careful note of our instructions on the operation of your microwave oven.
- AEG electrical appliances comply with all the valid safety requirements. Repairs to electrical appliances should only be performed by a trained electrician. Improper repairs may place the user at serious risk.

Technical data

MICROMAT DUO 21

Mains voltage:	230 V, 50 Hz
Power input:	2500 W
Output:	
– full power:	850 W (measured as in IEC 705: 1988)
– defrosting:	140 W
Micro-wave regulation:	5 (140/260/430/600/850 W)
Grill bar:	1300 W
Fuse:	16 A-L
Electronic timer:	60 minutes

Table-top model:

Diameter (height x width x depth) in mm	
Housing:	296 x 498 x 387
Interior:	185 x 315 x 315
Net weight:	17 kilos

CE This appliance complies with the following EC Directives: 73/23/EEC of 19. 2. 1973 – Low-Voltage Directive. 89/336/EEC of 3. 5. 1989 (incl. Amendment Directive 92/31/EEC) – EMC (Electromagnetic Compatibility) Directive.

Technical data

**Test procedure
Procedures for
Test Recipes**

**Microwave
output 850 w**

DIN Nr. 44 566 Part 2	Out- put	Time minutes	Stand time minutes	Comments Turntable in operation
Defrost Chicken	2	25-35	20	turn halfway through cooking
Defrost Minced beef	2	14-20	10	remove all defrosted meat after 10 minutes
Defrost Raspberries	2	8-12	10	cover
Defrost and reheat Goulasch	6	18-24	5	cover
Defrost spinach	6	18-24	5	cover
Defrost and cook fish fillet	9	10-12	3	cover. Halfway through cooking turn fillets so that inner edges face outwards
Defrost and cook Peas	6	8-12	5	cover. Stir halfway through cooking
Reheat Lentil Soup	8	10-14	5	cover. Stir halfway through heating
Cook Meatloaf	6	23-28	5	cover
Cook Chicken	6	20-30	5	turn halfway through cooking

ICE 705	Out- put	Time minutes	Stand time minutes	Comments Turntable in operation
Cook Fatless Sponge (Test B)	5	8-12	5	cook uncovered
Cook Meatloaf (Test C)	8	15-20	5	cover with foil. Where required remove shelf supports
Defrost Minced Beef	2	14-18	10	defrost uncovered
Reheat Lasagne 300 g (chilled food)	9	3-5		see cooking instructions on packet

MCAP601:1 04/93 GB/UK

AEG Hausgeräte AG
Postfach 1036
D-90327 Nürnberg 1
© Copyright by AEG

AEG Domestic Appliances Ltd
Customer Care Department
PO Box 47, Newbury
Berkshire, RG14 5XL
Telephone: 01635 572700
Fax: 01635 42970