

USER MANUAL

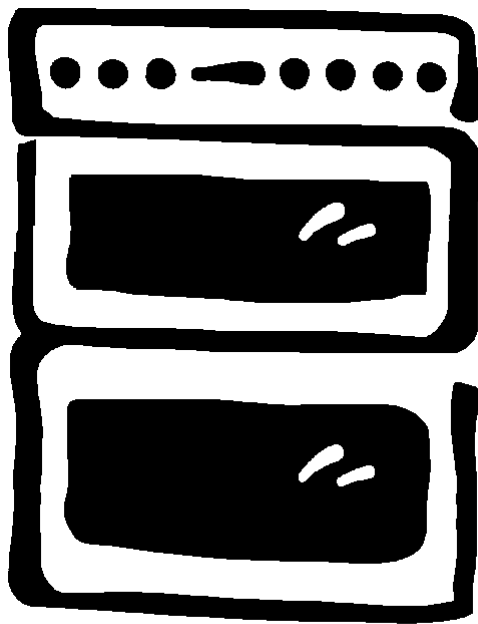

Model EKC6046 /EKC6047

INSIGHT



IMPORTANT SAFETY INFORMATION

These warnings are provided in the interests of your safety. Ensure that you understand them all before installing or using the appliance. Your safety is of paramount importance. If you are unsure about any of the meanings of these warnings contact the Customer Care Department.

INSTALLATION

The appliance **must** be installed according to the instructions supplied. The installation work must be undertaken by a qualified electrician or competent person.

The appliance should be serviced by an authorised Service Engineer and only genuine approved spare parts should be used.

The appliance **must** be installed in an adequately ventilated room.

If the appliance is to be placed on a base, measures must be taken to prevent the appliance from slipping.

This appliance is heavy and care **must** be taken when moving it.

Do not attempt to lift or move this appliance by the handles.

All packaging, both inside and outside the appliance **must** be removed before the appliance is used.

It is dangerous to alter the specifications or modify the appliance in any way.

After installation please dispose of the packaging with due regard for safety and the environment. Your local authority can arrange this.

CHILD SAFETY

Do not allow children to play with any part of the packaging.

Do not allow children to sit or climb on the drop down doors.

This appliance is not intended for use by children and other persons whose physical, sensory or mental capabilities or lack of experience and knowledge prevents them from using the appliance safely without supervision or instruction by a responsible person to ensure that they can use the appliance safely.

Children should be supervised to ensure that they do not play with the appliance.

CAUTION: Accessible parts may be hot when the grill is in use. Young children should be kept away.

DURING USE

This appliance is not intended to be operated by means of an external timer or separate remote control system.

This appliance has been designed for domestic use to cook edible foodstuffs only and **must not** be used for any other purposes.

Take great care when heating fats and oils as they will ignite if they become too **hot**.

Never place plastic or any other material which may melt in or on the oven.

Do not leave the grill pan handle in position when grilling as it will become **hot**.

Always support the grill pan when it is in the withdrawn or partially withdrawn position.

Always use oven gloves to remove and replace the grill pan handle when grilling.

Always use oven gloves to remove and place food in the oven.

Ensure cooking utensils are large enough to contain foods to prevent spillage and boil over.

The handles of saucepans, which are smaller than the heated area on the hob, will become hot.

Ensure your hand is protected before handling the pan.

Do not use the appliance if the ceramic glass is damaged. If a fault or crack becomes visible, disconnect the appliance immediately from the electricity supply and contact your local service force centre.

During use the appliance becomes hot. Care should be taken to avoid touching heating elements inside the oven.

Ensure that all vents are not obstructed to ensure ventilation of the oven cavity.

Never line any part of the appliance with foil.

Always stand back from the appliance when opening the doors to allow any build up of steam or heat to release.

Never leave the appliance unattended when the oven door is open.

Do not place sealed cans or aerosols inside the oven. They may explode if they are heated.

Ensure that all control knobs are in the OFF position when not in use.

Do not stand on the appliance or on the open oven doors.

Do not hang towels, dishcloths or clothes from the appliance or its handles.

Do not use this appliance if it is in contact with water. **Never** operate it with wet hands.

CLEANING AND MAINTENANCE

For hygiene and safety reasons this appliance should be kept clean at all times. A build-up of fats or other foodstuffs could result in a fire especially in the grill pan.

Do not leave the cookware containing foodstuffs, e.g. fat or oil in the appliance in case it is inadvertently switched on.

Extreme care must be taken when using a ceramic hob scraper.

Always allow the appliance to cool before switching off at the wall prior to carrying out any cleaning / maintenance work.

Only clean this appliance in accordance with the instructions given in this book.

Never use steam or high pressure steam cleaners to clean the appliance.

CONTENTS

FOR THE USER

Important Safety Information	2
Description of the Appliance	4
Getting to Know Your Appliance	5
Before Using the Appliance	6
Rating Plate	6
Preparing to Use your Appliance	6
The Cooling Fan for the Controls	6
Control Panel Indicator Neon(s)	6
Condensation and Steam	6
Cookware	6
Grill and Oven Furniture	6

The Timer	7
------------------	---

The Ceramic Hob	10
Using the Hob	10
Recommended Saucepans	10
Hints and Tips	11

The Grill	12
Using the Grill	12
Things to Note	12
The Grill Pan and Handle	12
Hints and Tips	12
Grilling Chart	13

The Top Oven	14
Using the Top Oven	14
Things to Note	14
To Fit the Top Oven Shelf	14
Hints and Tips	15

The Main Oven	16
Using the Main Oven	16
Things to Note	16
To Fit the Main Oven Shelves	16
Hints and Tips	17

Oven Cooking Chart	18
---------------------------	----

Roasting Chart	19
-----------------------	----

Defrost Feature	20
Using Defrost Feature	20
Things to Note	20
Hints and Tips	20

Care and Cleaning	21
Cleaning Materials	21
Cleaning the Outside of the Appliance	21
Cleaning the Control Knobs and Handles	21
Removing And Replacing Wirework Runners	21
Cleaning the Ceramic Hob	22
Hints and Tips	23
Cleaning the Shelves, Wirework Runners and Grill/Oven Furniture	23
Cleaning Inside the Grill and Oven Compartments	24
Hints and Tips	24
Cleaning the Door(s)	24
Replacing An Oven Light Bulb	26

Something Not Working?	27
Service and Spare Parts	28
Guarantee Conditions	29

FOR THE INSTALLER

Technical Details	30
Installation Instructions	31
Connecting to the Electricity Supply	32
Notes	33

To help you the following symbols will be found in the text.

 Hints and Tips

 Safety Instructions.

Please read the instruction book carefully before use and retain for future reference.

AT THE END OF THE APPLIANCE'S LIFE

The symbol  on the product or on its packaging indicates that this product may not be treated as household waste. Instead it shall be handed over to the applicable collection point for the recycling of electrical and electronic equipment. By ensuring this product is disposed of correctly, you will help prevent potential negative consequences for the environment and human health, which could otherwise be caused by inappropriate waste handling of this product. For more detailed information about recycling of this product, please contact your local city office, your household waste disposal service or the shop where you purchased the product.

DESCRIPTION OF THE APPLIANCE

SLIP-IN ELECTRIC DOUBLE OVEN

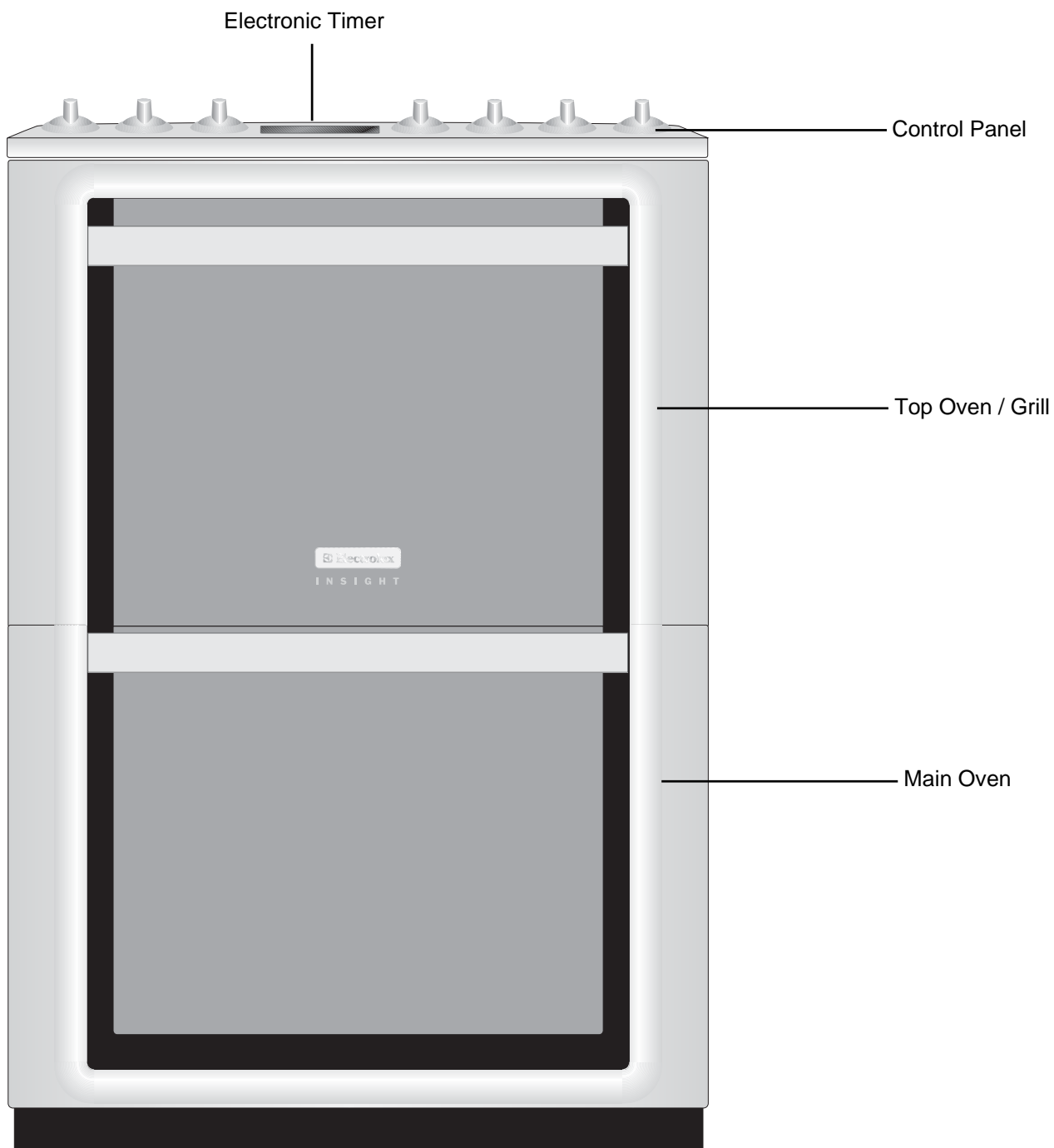

GETTING TO KNOW YOUR APPLIANCE

THE CONTROL PANEL

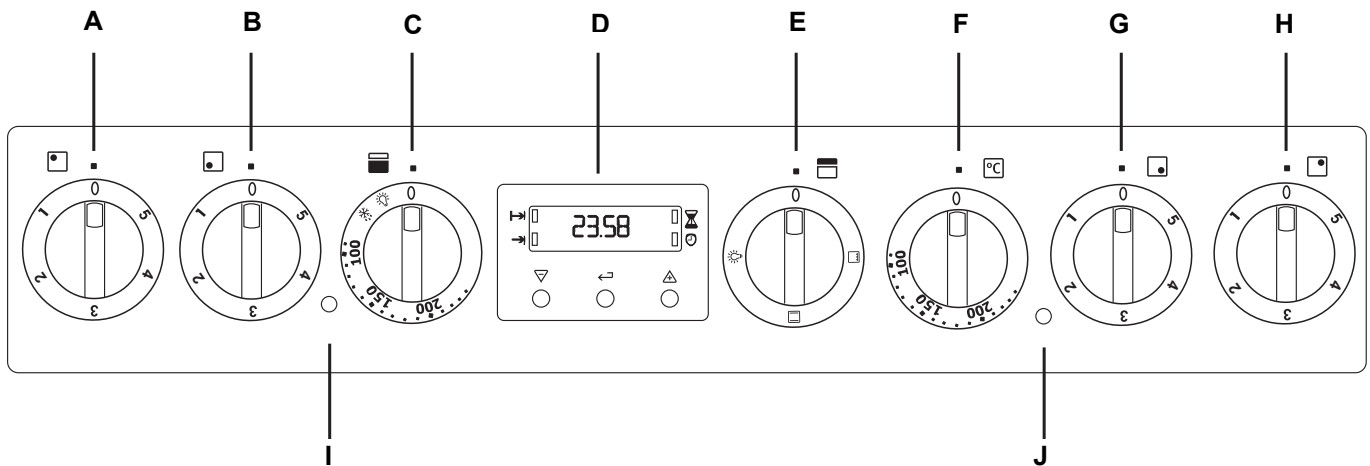

FEATURES

- A - Hotplate Control
- B - Hotplate Control
- C - Main Oven Temperature Control
- D - Electronic Timer
- E - Top Oven/Grill Selector Control
- F - Top Oven/Grill Temperature Control
- G - Hotplate Control
- H - Hotplate Control
- I - Main Oven Indicator Neon
- J - Top Oven/Grill Indicator Neon

BEFORE USING THE APPLIANCE

RATING PLATE

This is situated on the lower front frame of the appliance and can be seen upon opening the door. Alternatively the rating plate may also be found on the back or top of some models (where applicable).

The appliance must be protected by a suitably rated fuse or circuit breaker. The rating of the appliance is given on the rating plate.

Do not remove the rating plate from the appliance as this may invalidate the guarantee.

PREPARING TO USE YOUR APPLIANCE

Wipe over the base of the oven(s) with a soft cloth and hot soapy water and wash the furniture before use. We suggest that you run the oven(s) and grill for 10 – 15 minutes at maximum temperature, to burn off any residue from their surfaces. Accessible parts may become hotter than in normal use. Children should be kept away. During this period an odour may be emitted, it is therefore advisable to open a window for ventilation.

THE COOLING FAN FOR THE CONTROLS

The cooling fan comes on immediately when the grill/top oven is switched on and after a short time when the main oven is in use. It may run on after the controls are switched off until the appliance has cooled. During the initial period the cooling fan may turn ON and OFF, this is quite normal.



Always allow the cooling fan to cool the appliance down before switching off at the wall prior to carrying out any cleaning or maintenance work.

CONTROL PANEL INDICATOR NEON(S)

The indicator neon will operate when the grill (where applicable) or oven(s) is switched on. The indicator neon will glow. It may turn on and off during use to show that the setting is being maintained. If the neon does not operate as the instructions indicate the controls have been incorrectly set. Return all controls to zero and reset following the instructions for the required setting.

CONDENSATION AND STEAM

When food is heated it produces steam similar to a boiling kettle. The vents allow some of this steam to escape. However, always stand back from the appliance when opening the door(s) to allow any build up of steam or heat to release.

If the steam comes into contact with a cool surface on the outside of the appliance, e.g. a trim, it will condense and produce water droplets. This is quite normal and is not caused by a fault on the appliance. To prevent discolouration, regularly wipe away condensation and also soilage from surfaces.

For your safety wall coverings at the rear of the appliance should be securely fixed to the wall.

COOKWARE

Baking trays, dishes etc., should not be placed directly against the grid covering the fan at the back of the oven.

Do not use baking trays larger than 30cm x 35cm (12" x 14") as they will restrict the circulation of heat and may affect performance.

GRILL AND OVEN FURNITURE

The following items of grill and oven furniture have been supplied with the appliance. If you require replacements of any of the items listed below please contact your local Service Force Centre, quoting the relevant part number.

1 grill pan
(349099801)

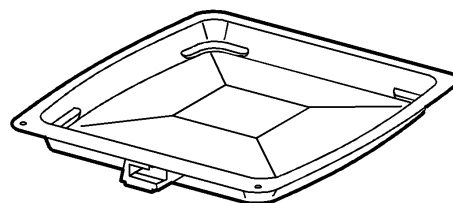

1 grill pan handle
(349100501)

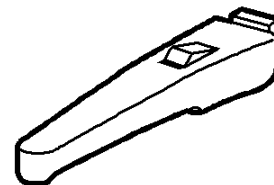

1 grill pan grid
(311757500)

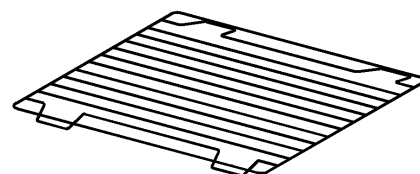

1 cranked shelf
(for grilling and
top oven cooking)

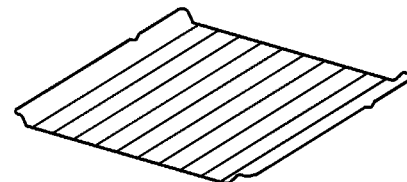

2 cranked shelves
(for main oven
cooking)

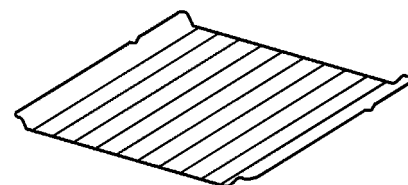

THE TIMER

KEY

- A COOK TIME
- B END TIME
- C COUNTDOWN
- D TIME
- E DECREASE CONTROL
- F SELECTOR CONTROL
- G INCREASE CONTROL

NOTE:

The time of day must be set before the main oven will operate manually.

1. HOW TO SET THE TIME OF DAY

The oven has a 24 hour clock.

When the electricity supply is first switched ON, the display will show 12.00 and the 'Time' indicator neon will flash as Fig. 1.

To set the correct time press the increase control button (+) and if necessary, the decrease control button (-) until the correct time on the 24 hour clock is reached, e.g. 10.00am as Fig. 2. The 'Time' indicator neon will flash for 5 seconds and then go out.

NOTE: The increase and decrease control buttons operate slowly at first, and then more rapidly. They should be pressed separately.

2. HOW TO SET THE COUNTDOWN

The 'Countdown' gives an audible reminder at the end of any period of cooking. This cooking period may be up to 2 hrs 30 mins. It is not part of the automatic control.

To set, press the Selector Control button until the 'Countdown' indicator neon is illuminated and the display reads 0.00 as Fig. 3.

To set the correct time duration depress the increase control (+) until the display indicates the interval to be timed, e.g. 1hr 45 mins as Fig. 4. If necessary depress the decrease control (-) to achieve the correct time interval.

NOTE: This must be completed within 5 seconds of first pressing the Selector Control button.

During the operation of the 'Countdown', the remaining time period will be shown in the display.

The 'Countdown' will sound intermittently for up to 2 minutes at the end of the timed period. The sound can be stopped by pressing any button.

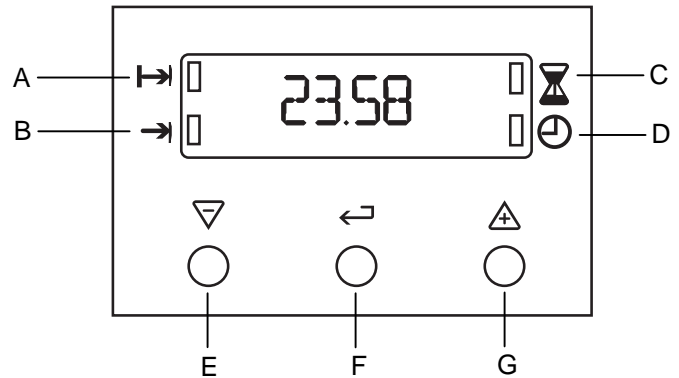

Fig.1.

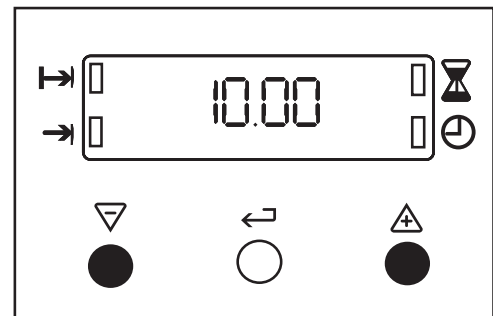

Fig.2.

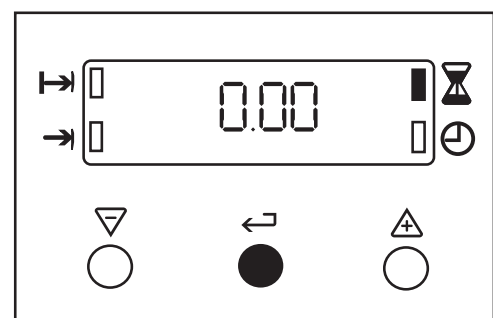

Fig.3.

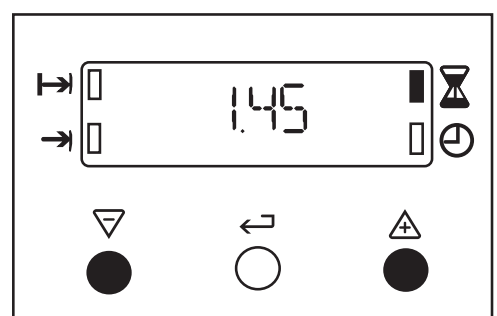

Fig.4.

TO CANCEL THE COUNTDOWN

If you change your mind and want to cancel the 'Countdown', press the Selector Control button until the 'Countdown' indicator neon flashes then depress the decrease control (-) until 0.00 shows in the display as Fig. 5. The 'Countdown' indicator neon will continue to flash for a few seconds and then return to the time of day.

3. SETTING THE OVEN TIMER CONTROL

The main oven only can be automatically timed.

When using the timer control for the very first time, it is advisable to let it operate while you are at home. The displays can be checked to show that it is operating correctly and you will feel confident to leave a meal to cook automatically in the future.

A) TO SET THE TIMER TO SWITCH ON AND OFF AUTOMATICALLY

- i) Ensure the electricity supply is switched ON and that the correct time of day is displayed, e.g. 9.a.m. as Fig. 6.
- ii) Place food in oven.
- iii) To set the length of cooking time. Press the Selector Control button until the 'Cook Time' indicator neon is illuminated. Press the increase control (+) until the required length of cooking time is displayed, e.g. 2 hrs 15 mins as Fig. 7. If necessary depress the decrease control (-) until the correct time interval is achieved.
The maximum cooking time is 10 hours.
- iv) Release the buttons. The 'Cook Time' indicator neon will be illuminated.

Remember, this must be completed within 5 seconds of first pressing the Selector Control button.

- v) To set the 'End Time'. Press the Selector Control button until the 'End Time' indicator neon flashes. Press the increase control button (+) until the required stop time is displayed, e.g. 12.15 p.m. as Fig. 8. If necessary depress the decrease control (-) until the correct time interval is achieved.
- vi) Release the buttons. The time of day will be displayed after 5 seconds. The 'Cook Time' and 'End Time' indicator neons will be illuminated.
The 'End Time' must not be more than 23 hours 59 minutes from the time of day. For example, if the time of day is 09.00 a.m., the latest 'End Time' would be 08.59 a.m. the next day.
- vii) Set the main oven control to the required temperature. The oven indicator neon should be OFF.

NOTE: When the automatic timed period starts, the oven indicator neon will turn ON and OFF periodically during cooking, showing that the temperature is being maintained.

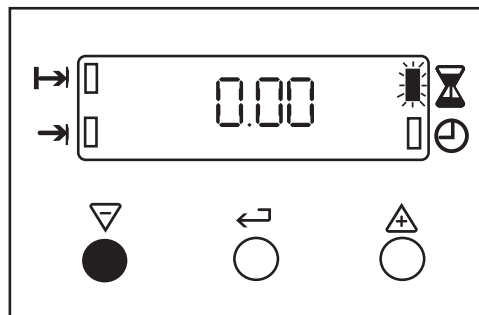

Fig.5.

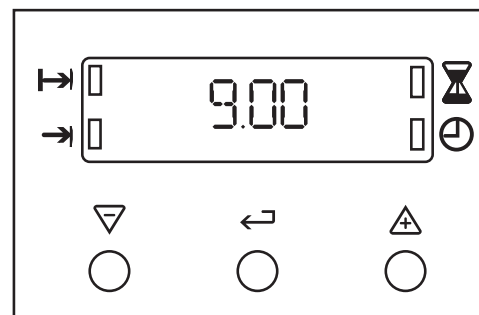

Fig.6.

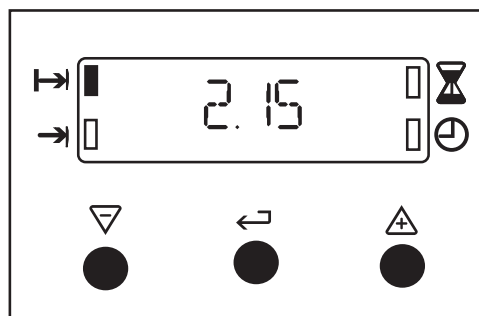

Fig.7.

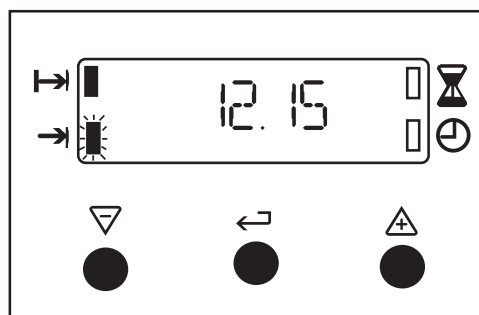

Fig.8.

B) TO SET THE TIMER TO SWITCH OFF ONLY

- i) Ensure the electricity supply is switched ON and that the correct time of day is displayed, e.g. 10.00am as Fig. 9.
- ii) Place food in the oven.
- iii) To set the length of cooking time, press the Selector Control button until the 'Cook Time' indicator neon is illuminated. Press the increase control (+) until the required length of cooking time is displayed, e.g. 2 hrs 15 mins as Fig. 10. Depress the decrease control (-) if necessary.
- iv) Release the buttons. The 'Cook Time' indicator neon will illuminate and the time of day will be displayed after 5 seconds.
- v) Set the oven temperature. The oven indicator neon should be ON.
- vi) To check the 'End Time' during the cooking period, simply press the Selector Control button once and the remaining time will be displayed, as Fig. 11.

4. TO CANCEL AN AUTOMATIC PROGRAMME

- i) To cancel an automatic programme press the Selector Control button until the 'Cook Time' indicator neon flashes. Press the decrease control (-) until the display reads 0.00 as Fig. 12.
- ii) Release the buttons. The 'Cook Time' indicator neon will flash and after 5 seconds return to the time of day.
- iii) Turn off the oven controls.

5. TO RETURN THE APPLIANCE TO MANUAL

At the end of a timed cooking period, the indicator neon will flash and an alarm will sound for up to 2 minutes.

- i) To stop the sound press any of the three buttons, as Fig. 13.
- ii) The display will return to the time of day.
- iii) Turn off the oven controls.

6. THINGS TO NOTE

In the event of an interruption of the electricity supply, the timer will reset itself to zero, and all programming will be cancelled.

7. AUTOMATIC COOKING

It is advisable to leave food in the oven for as short a time as possible before automatic cooking. Always ensure commercially prepared food is well within its use by date and that home prepared food is fresh and of good quality. When cooking is complete, **do not** leave food to stand in the oven, but remove and cool it quickly if the food is not to be consumed immediately. Always ensure food in the oven has been covered before cooking if it is not possible to remove food immediately after cooking.

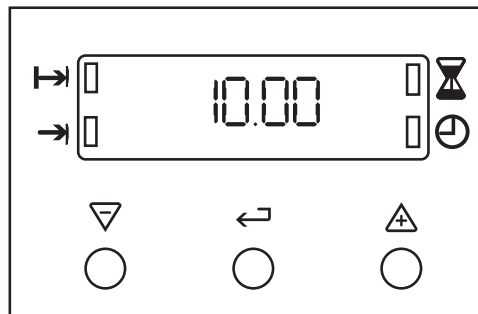

Fig.9.

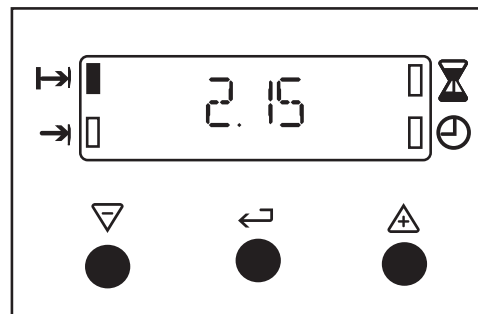

Fig.10.

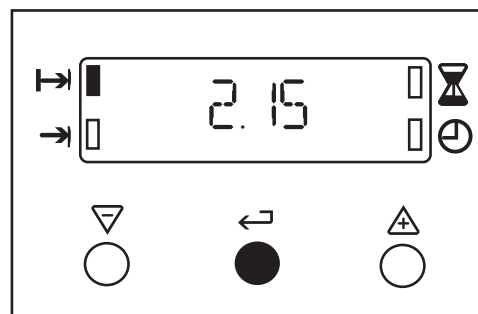

Fig.11.

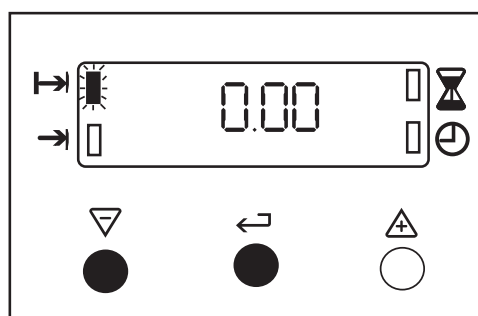

Fig.12.

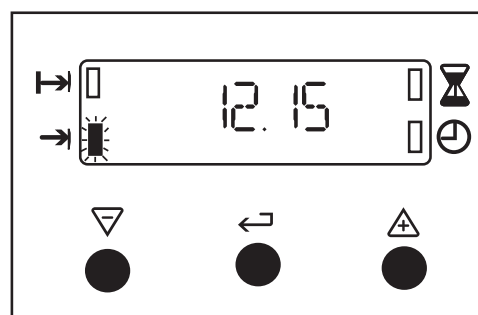

Fig.13.

THE CERAMIC HOB



Do not use the appliance if the ceramic glass is damaged. If a fault or crack becomes visible, disconnect the appliance immediately from the electricity supply and contact your local Service Force Centre.

USING THE HOB

- To operate the hotplates, turn the control knob in either direction to vary the heat setting.
- The highest number represents the hottest setting and the lowest number represents the coolest setting. Choose a setting appropriate to the quantity and type of food to be cooked.

RECOMMENDED SAUCEPANS

Only saucepans with flat bases and close fitting lids are recommended. The saucepan base should be approximately the same size as the cooking area. Ensure that new saucepans are well scrubbed to remove edges and take off any deposits left from manufacture.

Traditional round bottomed Woks **must not be** used even with a stand. Woks with flat-bottomed bases are available and do comply with the above recommendations.

NOTE:

Occasionally the heated areas may be seen to switch ON and OFF when higher heat settings are being used. This is due to a safety device which prevents the glass from overheating.

Some switching ON and OFF when cooking at high temperatures, e.g. deep fat frying is quite normal, causes no damage to the hob and little delay in cooking times.

Excessive switching may however be caused by the use of an unsuitable saucepan or a saucepan which is smaller than the heated area. If excessive switching occurs, discontinue use of the saucepan.

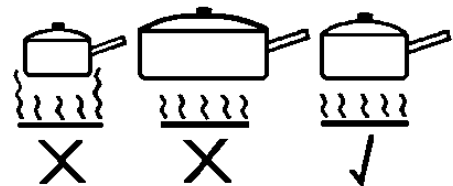
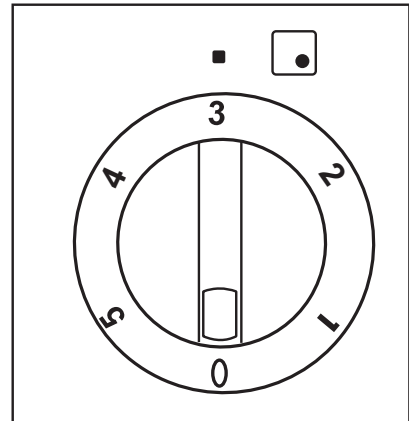

i HINTS AND TIPS

- Lift, rather than slide saucepans on and off the hob. This will reduce the risk of scratches and metal marks from saucepans with aluminium bases. Metal marks can be easily cleaned off providing they are not allowed to burn on.
- Follow any guidelines provided by the saucepan manufacturer, particularly those relating to recommended heat settings.
- Avoid using thin, badly dented or distorted saucepans. Those with uneven bases should not be used.
- Never leave the hotplates ON when not covered with a saucepan.
- Ensure that the hob and saucepans are clean and dry before the start of cooking.
- Follow the cleaning instructions very closely to keep the hob looking like new.
- **If spillage occurs with sugar solutions, e.g. jams and syrups, it must be wiped from the hob before it sets and becomes hard otherwise damage to the hob will occur.**

HOT HOB INDICATOR

The hob is fitted with a hot hob indicator light which illuminates when the hob is too hot to touch. The light will go OFF when the hob has cooled.

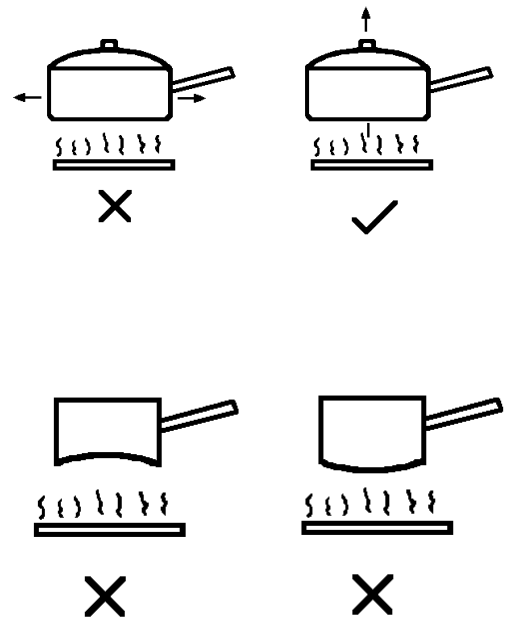

THE GRILL



CAUTION – Accessible parts may be hot when the grill is in use. Young children should be kept away.

USING THE GRILL

- To operate the grill select the grill function for full grill. 
- Turn the temperature control knob to the right as far as it will go. This is the hottest setting.
- To use the grill at lower settings, turn the temperature control knob so that 110°C or 150°C on the knob lines up with the off dot on the panel.

THINGS TO NOTE

- The cooling fan for the controls may operate after a time.
- Some smoke from fat splashes may be evident as the grill cleans itself.
- The Top oven cannot be operated when the grill is in use.
- To ensure optimal cooking performance the elements have been carefully designed, so that only the inner element glows red. The outer element is hot, but will remain dark in colour. This gives you the best possible cooking results.

THE GRILL PAN AND HANDLE

The grill pan is supplied with a removable handle. To attach the handle, press the button on the handle with the thumb and insert the lip into the widest part of the bracket. Slide the handle towards the left and release the button.



Ensure the handle is correctly located.

To remove the handle, press the button on the handle with the thumb and slide the handle towards the right. Release the button.



Always remove the grill pan handle during grilling.

Place the grill pan on the shelf so that the pan is positioned centrally beneath the grill. Ensure that the cut out on the underside of the handle bracket locates between the bars of the shelf.

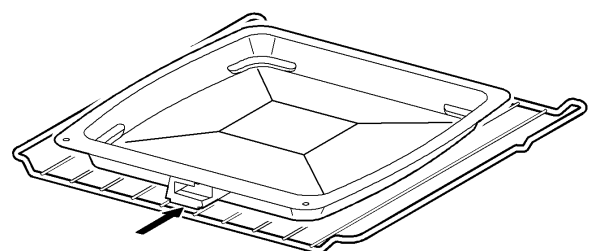
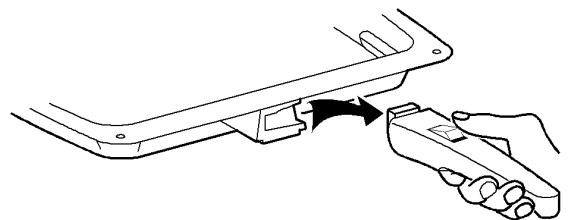
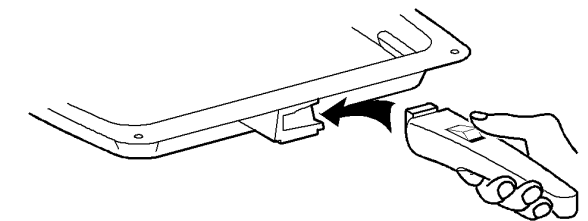
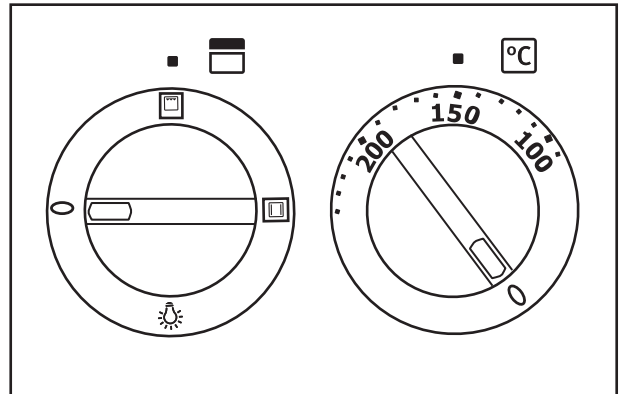

i HINTS AND TIPS

- Most foods should be placed on the grid in the grill pan to allow maximum circulation of air to lift the food out of the fats and juices.
- Adjust the grid and grill pan runner position to allow for different thicknesses of food. Position the food close to the element for faster cooking and further away for more gentle cooking.
- Food should be thoroughly dried before grilling to minimise splashing. Brush lean meats and fish lightly with a little oil or melted butter to keep them moist during cooking.
- Accompaniments such as tomatoes and mushrooms may be placed underneath the grid when grilling meats.
- When toasting bread, use the shelf in position 6 with the grid in the 'high' position.
- Preheat the grill on a full setting for a few minutes before sealing steaks or toasting. Adjust the heat setting and the shelf as necessary during cooking.
- The food should be turned over during cooking as required.

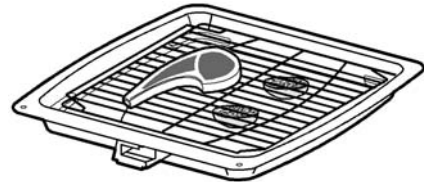

GRILLING CHART

FOOD	POSITION	GRILL TIME (mins in total)
Bacon Rashers	Adjust grill setting and grill pan grid to suit different thicknesses of food	5 - 6
Beefburgers		10 - 15
Chicken Joints		30 - 40
Chops – Lamb		15 - 20
Pork		20 - 30
Fish – Whole Trout/Mackerel		15 - 25
Fillets - Plaice/Cod		10 - 15
Kebabs		20 - 30
Kidneys – Lamb/Pig		8 - 12
Liver – Lamb/Pig		10 - 20
Sausages		20 - 30
Steaks – Rare		6 - 12
Medium		12 - 16
Well Done		14 - 20
Toasted Sandwiches		3 - 4

The times quoted above are given as a guide and should be adjusted to suit personal taste.

THE TOP OVEN

The top oven is the smaller of the two ovens. It is heated by elements in the top and bottom of the oven. It is designed for cooking smaller quantities of food. It gives especially good results if used to cook fruit cakes, sweets and savoury flans or quiche.

The top oven is also ideal for use as warming compartment to warm dishes and keep food hot. Use the top oven when you want to warm plates. Use the lowest setting on the top oven temperature control.

USING THE TOP OVEN

- Turn the top oven/grill selector to top oven. 
- Turn the top oven temperature control to the required setting.

THINGS TO NOTE

- The oven light will illuminate.
- The indicator neon will glow. It may turn ON and OFF during use to show that the setting is being maintained.
- The cooling fan for the controls may operate after a time.
- The grill cannot be operated when the top oven is in use.

 **Do not place dishes, tins and trays directly on the oven base as it becomes very hot and damage will occur.**

TO FIT THE TOP OVEN SHELF

The shelf should be fitted with the straight rods uppermost on the frame and the forms towards the back of the oven. To remove a shelf slide the shelf towards you until the shelf stop is reached. Tilt shelf up at the front so that the stops clear the side supports. Lift shelf clear. To install a shelf, reverse the above steps. Each shelf position has an upper and lower support wire, ensure the shelf is placed between these two support wires.

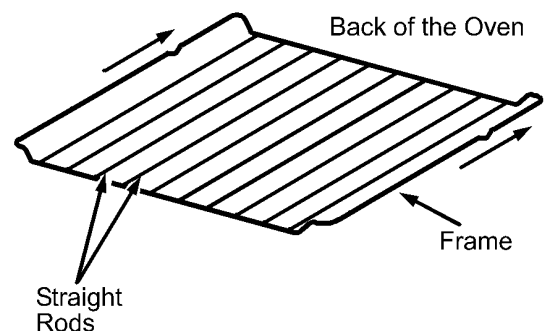
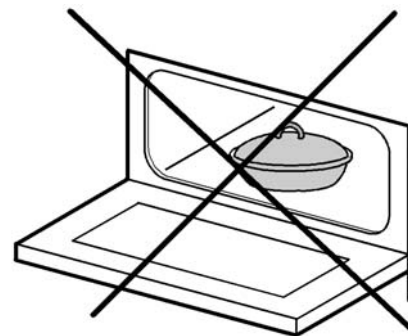
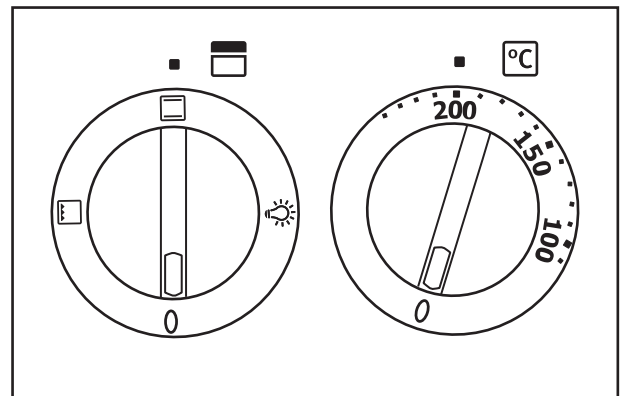

HINTS AND TIPS

- Arrange the shelves in the required positions before switching the oven ON. Shelf positions are counted from the bottom upwards.
- There should always be at least 2.5cm (1") between the top of the food and the element. This gives best cooking results and allows room for rise in yeast mixtures, Yorkshire puddings etc. When cooking cakes, pastry, scones bread etc., place the tins or baking trays centrally on the shelf.
- Ensure that food is placed centrally on the shelf and there is sufficient room around the baking tray/dish to allow for maximum circulation.
- Stand dishes on a suitably sized baking tray on the shelf to prevent spillage onto the oven base and to help reduce cleaning.
- The material and finish of the baking tray and dishes used affect base browning. Enamelware, dark, heavy or non-stick utensils increase base browning. Shiny aluminium or polished steel trays reflect the heat away and give less base browning.
- Because of the smaller cooking space and lower temperatures, shorter cooking times are sometimes required. Be guided by the recommendations given in the cooking chart.
- **Do not** place baking trays directly on the oven base as it interferes with the oven air circulation and can lead to base burning; use the lower shelf position.
- For economy leave the door open for the shortest possible time, particularly when placing food into a pre-heated oven.



Do not place cookware and cooking pots with rough bases e.g. cast iron on the oven door as damage to the glass may occur.

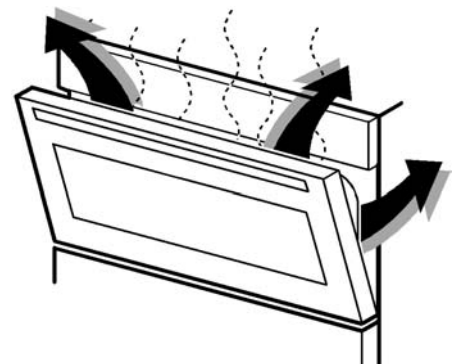
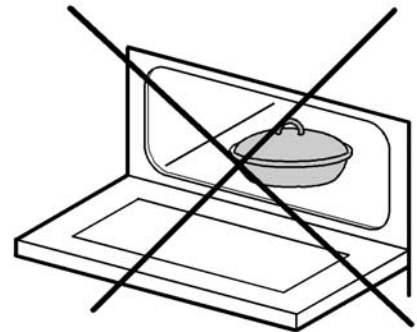
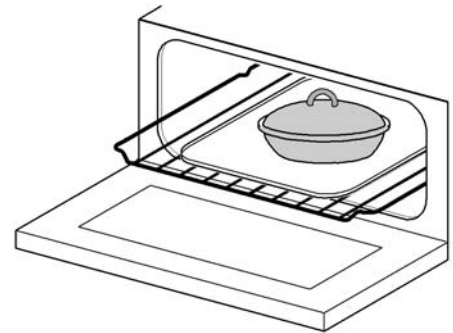
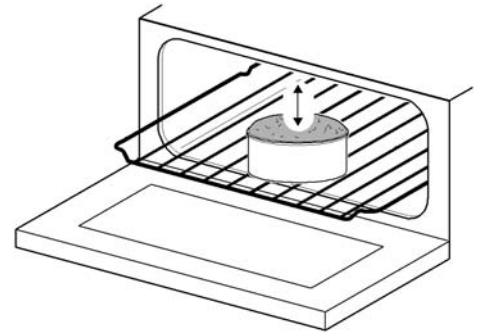

THE MAIN OVEN

The fan oven is particularly suitable for cooking larger quantities of food. The advantages of fan oven cooking are:

PREHEATING

The fan oven quickly reaches its temperature, so it is not usually necessary to preheat the oven. Without preheating however, you may need to add an extra 5 – 10 minutes on the recommended cooking times. For recipes needing high temperatures, e.g. bread, pastries, scones, soufflés etc., best results are achieved if the oven is preheated first. For best results when cooking frozen or cooked chilled ready meals always preheat the oven first.

COOKING TEMPERATURES

Fan oven cooking generally requires lower temperatures than conventional cooking. Follow the temperatures recommended in the cooking chart. As a guide reduce temperatures by about 20°C – 25°C for your own recipes, using a conventional oven.

BATCH BAKING

The fan oven cooks evenly on both shelf levels, especially useful when batch baking.

USING THE MAIN OVEN

- Turn the main oven temperature control to the required setting.

THINGS TO NOTE

- The oven light will illuminate.
- The indicator neon will glow. It may turn ON and OFF during use to show that the setting is being maintained.
- The cooling fan for the controls may operate after a time.
- The oven fan will operate.
- If an automatic programme has been set, the oven light will not come on until cooking begins.

TO FIT THE MAIN OVEN SHELVES

The shelf should be fitted with the straight rods uppermost on the frame and the forms towards the back of the oven. To remove a shelf slide the shelf towards you until the shelf stop is reached. Tilt shelf up at the front so that the stops clear the side supports. Lift shelf clear. To install a shelf, reverse the above steps. Each shelf position has an upper and lower support wire, ensure the shelf is placed between these two support wires.

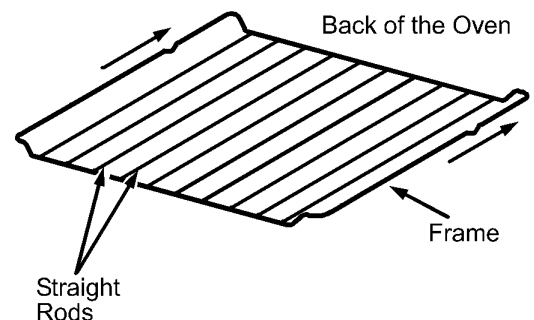
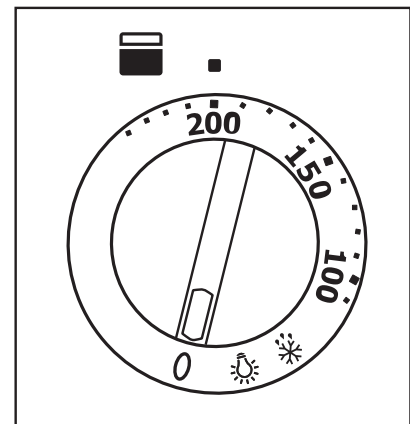

i HINTS AND TIPS

- Arrange the shelves in the required positions before switching the oven ON. Shelf positions are counted from the bottom upwards.
- When cooking more than one dish in the fan oven, place dishes centrally on different shelves rather than cluster several dishes on one shelf, this will allow the heat to circulate freely for the best cooking results.
- When batch baking one type of food, e.g. Victoria sandwich cakes, those of similar size will be cooked in the same time.
- It is recommended that when baking larger quantities the shelf positions should be evenly spaced to suit the load being cooked. A slight increase in cooking time may be necessary.
- **Do not** place baking trays directly on the oven base as it interferes with the oven air circulation and can lead to base burning; use the lower shelf position.



Do not place cookware and cooking pots with rough bases e.g. cast iron on the oven door as damage to the glass may occur.

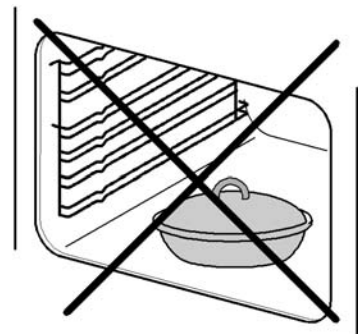
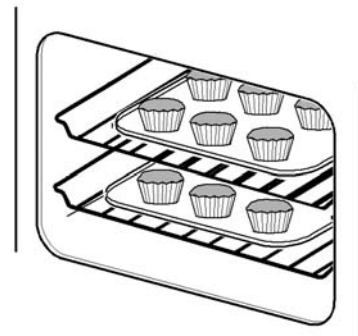
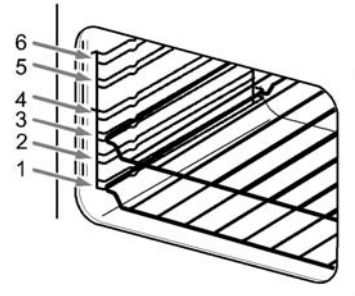

OVEN COOKING CHART

The oven temperatures are intended as a guide only. It may be necessary to increase or decrease the temperatures by 10°C to suit individual preferences and requirements.

FOOD		FAN OVEN		TOP OVEN		
		SHELF POSITION	COOKING TEMP °C	SHELF POSITION	COOKING TEMP°C	APPROX COOK TIME (m)
Biscuits			180 - 190	4	170 - 190	10 - 20
Bread		Shelf	200 - 220	1	200 - 220	25 - 30
Bread rolls/buns			200 - 220	1	200 - 220	15 - 20
Cakes:	Small & Queen		160 - 170	4	170 - 180	18 - 25
	Sponges		160 - 170	3	160 - 170	18 - 20
	Victoria Sandwich	positions	160 - 170	3	160 - 170	18 - 25
	Madeira		140 - 150	2	140 - 150	1¼ - 1½h
	Rich Fruit		130 - 140	2	140 - 150	2¼ - 2½h
	Christmas	are not	130 - 140	1	130 - 140	3 - 4½h
						depends on size
	Gingerbread		140 - 150	3	140 - 150	1¼ - 1½h
	Meringues	critical	80 - 100	2	90 - 100	2½ - 3h
	Flapjack		170 - 180	3	170 - 180	25 - 30
	Shortbread		130 - 140	3	140 - 150	45 - 65
Casseroles:	Beef/Lamb	but ensure	140 - 160	2	140 - 160	2½ - 3h
	Chicken		180 - 190	2	180 - 190	1¼ - 1½h
Convenience Foods			Follow manufacturer's instructions			
Fish		that oven	170 - 190	3	170 - 190	20 - 30
Fish Pie (Potato Topped)			190 - 200	2	190 - 200	20 - 25
Fruit Pies, Crumbles			190 - 200	2	190 - 200	40 - 50
Milk Puddings		shelves	130 - 140	3	140 - 150	1½ - 2h
Pasta Lasagne etc.			190 - 200	3	170 - 180	40 - 45
Pastry:						
	Choux	are	190 - 200	3	180 - 190	30 - 35
	Eclairs, Profiteroles		170 - 180	3	170 - 180	20 - 30
	Flaky/Puff Pies		210 - 220	3	210 - 220	25 - 40
Shortcrust	Mince Pies	evenly	190 - 200	3	190 - 200	15 - 20
	Meat Pies		190 - 210	3	190 - 210	25 - 35
	Quiche, Tarts, Flans		180 - 210	3	180 - 200	25 - 45
		spaced				
Roasting Meat, Poultry			160 - 180	2	160 - 180	see roasting chart
Scones		when more	210 - 220	4	220 - 230	8 - 12
Shepherd's Pie			190 - 200	2	190 - 200	30 - 40
Soufflés			170 - 180	3	170 - 180	20 - 30
Vegetables:	Baked Jacket Potatoes	than one is	180 - 190	3	180 - 190	1 - 1½h
	Roast Potatoes		180 - 190	4	180 - 190	1 - 1½h
Yorkshire Puddings:						
	Large	used	210 - 220	4	200 - 210	25 - 40
	Individual		200 - 210	4	200 - 210	15 - 25

Note: Shelf positions are counted from the bottom of the oven.

ROASTING CHART

INTERNAL TEMPERATURES – Rare : 50-60°C; Medium : 60-70°C; Well done : 70-80°C		
MEAT	TEMPERATURE	COOKING TIME
Beef/ Beef boned	160-180°C	20-35 minutes per ½kg (1lb) and 20-35 minutes over
Mutton/Lamb	160-180°C	25-35 minutes per ½kg (1lb) and 25-35 minutes over
Pork/Veal/Ham	160-180°C	30-40 minutes per ½kg (1lb) and 30-40 minutes over
Chicken	160-180°C	15-20 minutes per ½kg (1lb) and 20 minutes over
Turkey/Goose	160-180°C	15-20 minutes per ½kg (1lb) up to 3½kg (7lb) then 10 minutes per ½kg (1lb) over 3½kg (7lb)
Duck	160-180°C	25-35 minutes per ½kg (1lb) and 25-30 minutes over
Pheasant	160-180°C	35-40 minutes per ½kg (1lb) and 35-40 minutes over
Rabbit	160-180°C	20 minutes per ½kg (1lb) and 20 minutes over

The roasting temperatures and times given in the chart should be adequate for most joints, but slight adjustments may be required to allow for personal requirements and the shape and texture of the meat. However, lower temperatures and longer cooking times are recommended for less tender cuts or larger joints.

Wrap joints in foil if preferred, for extra browning uncover for the last 20 – 30 min. cooking time.

DEFROST FEATURE

This main oven function defrosts most foods faster than more conventional methods. It is particularly suitable for delicate frozen foods which are to be served cold e.g. cream filled gateaux, cakes covered with icings or frostings, cheesecakes, biscuits, scones, etc.

USING DEFROST FEATURE

- Turn the main oven temperature control to the defrost setting. ❄️
- When defrost is selected, the oven indicator neon may come ON. It will stay ON until the oven reaches room temperature and then go OFF.
- It may turn ON and OFF periodically during defrosting to maintain a steady room temperature, inside the oven.

THINGS TO NOTE

- The oven fan and interior light will come on.

i HINTS AND TIPS

- Place the frozen food in a single layer where possible and turn it over half way through the defrosting process.
- The actual speed of defrosting is influenced by room temperature. On warm days defrosting will be faster than on cooler days.
- It is preferable to thaw fish, meat and poultry slowly in the fridge. However, this process can be accelerated by using the defrost function. Small or thin fish fillets, frozen peeled prawns, cubed or minced meat, liver, thin chops, steaks etc., can be thawed in 1 – 2 hours.
- A 1kg/2¼lb oven ready chicken will be thawed in approximately 5 hours. Remove the giblets as soon as possible during the thawing process.
- Joints of meat up to 2kg/4½lb in weight can be thawed using the defrost function.
- All joints of meat and poultry must be thawed thoroughly before cooking.
- Always cook thoroughly immediately after thawing.
- **Do not** leave food at room temperature once it is defrosted. Cook raw food immediately or store cooked food in the fridge, once it has cooled.
- Care must always be taken when handling foods in the home. Always follow the basic rules of food hygiene to prevent bacterial growth and cross contamination when defrosting, preparing, cooking, cooling and freezing foods.

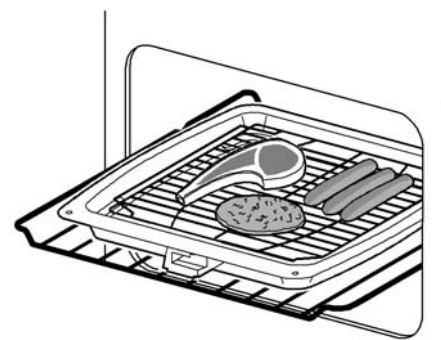
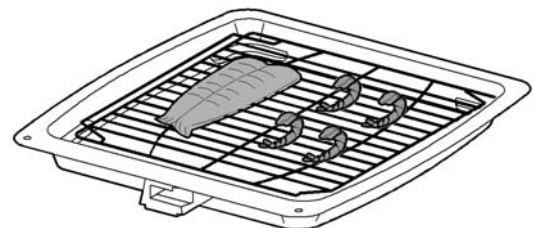
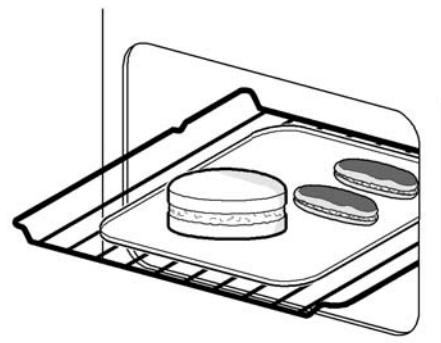
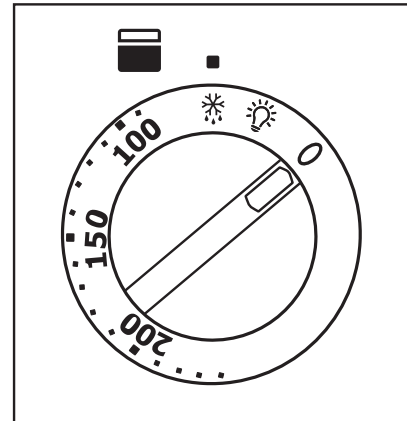

CARE AND CLEANING

 **Before cleaning always allow the appliance to cool down before switching off at the electricity supply.**

CLEANING MATERIALS

Before using any cleaning materials on your appliance, check that they are suitable and that their use is recommended by the manufacturer.

Cleaners that contain bleach should NOT be used as they may dull the surface finishes. Harsh abrasives and scourers should also be avoided. Multi-surface anti-bacterial cleaning products should not be used on the ceramic hob or on the surrounding trims.

CLEANING THE OUTSIDE OF THE APPLIANCE

Do not use abrasive cleaning materials e.g. Hob Brite, Brillo pads or scourers on painted or printed finishes as damage may occur. Regularly wipe over the control panel, doors and appliance sides using a soft cloth and hot soapy water. To prevent streaking finish with a soft cloth.

Stainless Steel cream cleaners are abrasive and should be avoided as they may dull the surface finish. **Any spillage on the stainless steel finish must be wiped off immediately.**

 **Do not attempt to remove any of the control knobs from the appliance as this may cause damage and is a safety hazard.**

CLEANING THE CONTROL KNOBS AND HANDLES

It is strongly recommended that only hot soapy water is used for cleaning the control knobs and handles. **ANY OTHER CLEANING MATERIALS MAY DULL THE SURFACE FINISH.**

REMOVING AND REPLACING THE WIREWORK RUNNERS

1. Remove all shelves and furniture from the oven.
2. Hold the wirework at the bottom, unclip from the cavity side and gently pull towards the centre of the oven.
3. Unhook the runner at the top and remove from the cavity.
4. To replace the runners, hook the wirework side runner into the cavity, slide back and press into place.

 **Ensure the wirework runners are firmly in position before replacing the oven shelves.**

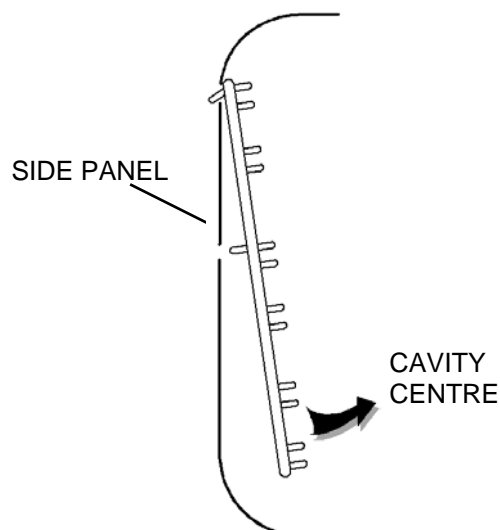
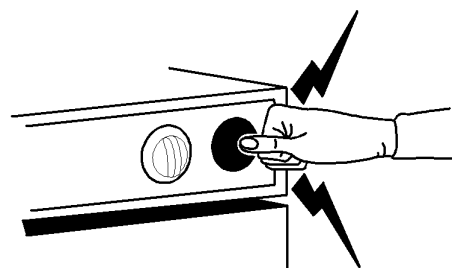
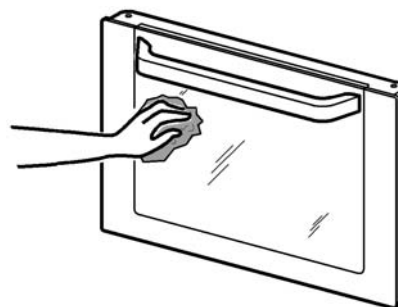

CLEANING THE CERAMIC HOB

Make sure the ceramic glass is cool before cleaning. It is important to clean the ceramic hob daily to prevent soilage being burnt on.

Take care to avoid the hob trims when cleaning the ceramic glass as they may be damaged by the cleaning agents recommended.

DAILY CLEANING

Use the recommended Hob Brite Cleaner daily. If soilage is not allowed to burn on it will be much easier to clean off.

1. Apply a small amount of Hob Brite in the centre of each area to be cleaned.
2. Dampen a clean paper towel or a plastic pad made specially for non-stick saucepans and rub vigorously until all marks are removed. This may take a few minutes.
3. Wipe off residues of cleaner with another damp paper towel and polish dry with a soft cloth.

If Hob Brite is unavailable, one or more of the cleaning agents below may be used temporarily:

- a) Cif Cream Cleaner
- b) Baking Soda

TO REMOVE MORE STUBBORN MARKS

1. Bar Keepers Friend may be used to clean off more stubborn stains or to remove discolourations. It may be necessary to rub the marks hard for several minutes.
2. Use a plastic pad specially for non-stick saucepans with Bar-Keepers Friend for removal of more stubborn soilage.

TO REMOVE BURNT ON SOILAGE

We strongly recommend the use of a Ceramic Hob Scraper (incorporating a single edge razor blade) to remove spillage on the hob, in particular sugar solutions, which if not removed can cause permanent damage.

1. Make sure the ceramic glass is cool.
2. Use a ceramic hob scraper with care at an angle of 30° to remove as much soilage as possible.
3. Use Bar-Keepers Friend or Hob Brite to finish off as directed above.

TO REMOVE DISCOLOURATIONS OR WHITE AND SILVER MARKS

These marks sometimes give the impression of being in or underneath the hob glass. They can almost always be removed provided they have not become excessively burnt on. Follow the instructions above under 'To Remove more Stubborn Marks'.

If this is unsuccessful, make up a paste of one part water to three parts Cream of Tarter and leave on the discoloured areas overnight. The marks should be easily removable the next day provided they have not been excessively burnt on. The paste should be thoroughly washed off afterwards.

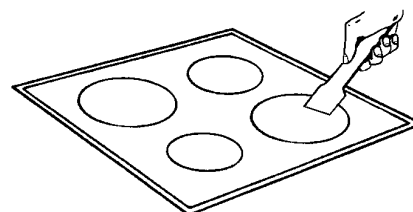
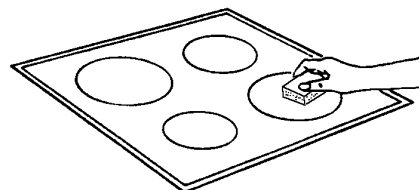
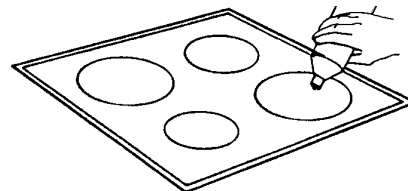



HINTS AND TIPS

TO REDUCE HOB SOILAGE:

- Make sure the bottom of the saucepan and the cooking area are clean and dry before cooking begins.
- Ensure saucepans are large enough to accommodate food to avoid boil overs.
- If possible, wipe up spills and splatters as they occur, but take care to avoid steam burns.
- Avoid using a dishcloth or sponge to clean the hob. These may leave a layer of soiled detergent on the hob surface which will burn and discolour the next time the hob is used.
- Avoid the use of:
 - Household detergents and bleaches.
 - Impregnated plastic or nylon pads that are not described as suitable for non-stick saucepans.
 - Brillo pads, Ajax pads, steel wool pads.
 - Chemical oven cleaners, e.g. aerosols and oven pads.
 - Rust stain, bath and sink stain removers.
- **Any of the above products may cause damage to the hob.**
- It is dangerous to mix different cleaning products. The chemicals in them may react with each other with hazardous results.
- **Soilage from sugar solutions must be removed from the hob before the syrup has set otherwise damage to the hob surface will occur.**
- Avoid placing plastic items, foil or dishes on the hot surface as this will cause damage to the hob.

CLEANING THE SHELVES, WIRE- WORK RUNNERS AND GRILL/OVEN FURNITURE

All removable parts, except the grill pan handle can be washed in the dishwasher.

The grill pan, grill pan grid, oven shelves and wirework runners may be cleaned using a soap impregnated steel wool pad. Soaking first in hot soapy water will make cleaning easier.

CLEANING INSIDE THE GRILL AND OVEN COMPARTMENTS

The sides and back of the grill/second oven and main oven compartments are coated with a special Stayclean coating. They should not be cleaned manually.

The vitreous enamel main oven base and grill compartment base can be cleaned using normal oven cleaners with care. Ensure that the manufacturers instructions are followed and that all parts are well rinsed afterwards.



Aerosol cleaners must not come into contact with elements, the door seal, or any painted finishes as this may cause damage.



HINTS AND TIPS



Aerosol cleaners must not be used on Stayclean surfaces.

Stayclean surfaces destroy splashes of food and fats when the oven temperature is raised to around 220°C.

It is a good idea to run the oven for an hour or two per week to ensure continued good performance from the Stayclean finish.

Slight discolouration and polishing of the Stayclean surfaces may occur in time. This **DOES NOT** affect the Stayclean properties in any way.

Use minimal, if any, extra oil or fat when roasting meat, potatoes only require brushing with fat before cooking. Extra fat in the oven during roasting will increase splashing and soilage.

It is NOT necessary to add water to a meat tin when roasting. The water and the fat juices from the joint create excessive splattering during cooking – even at normal temperatures, as well as causing condensation.

Covering joints during cooking will also prevent splashing onto the interior surfaces. Removing the covering for the last 20-30 minutes will allow extra browning if required. Some large joints and turkeys especially benefit by this method of cooking, allowing the joint to cook through before the outside is over-browned.

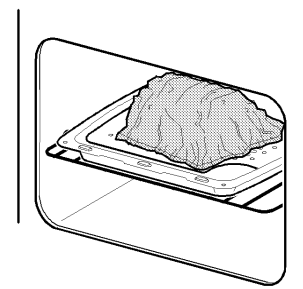
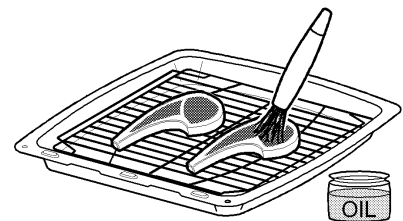

CLEANING THE DOOR(S)



To prevent damaging or weakening the door glass panels avoid the use of the following:

- Household detergents and bleaches
- Impregnated pads unsuitable for non-stick saucepans
- Brillo/Ajax pads or steel wool pads
- Chemical oven pads or aerosols
- Rust removers
- Bath/Sink stain removers

CLEANING BETWEEN THE OUTER AND INNER DOOR GLASS

The inner door glass is removable for cleaning.

TO REMOVE THE INNER GLASS

Open the oven door to gain access to the top of the oven door.

To remove the top trim:-

Top Oven - Carefully pull the trim away from the door and lift off.

Main Oven - Carefully push the trim towards the oven. Remove the seal.

Hold the door glass securely in place with one hand before sliding the glass out with the other hand.

Clean the outer and inner glass using hot soapy water or Hob Brite cleaner may be used. **Do not** use Hob Brite on the Stainless Steel or painted finishes. Ensure that all parts are well rinsed and thoroughly dried before attempting to replace the outer door.



If the door glass panel becomes chipped or has deep scratches the glass will be weakened and must be replaced to prevent the possibility of the panel shattering. Please contact your local Service Force Centre who will be pleased to advise further.

TO REPLACE THE INNER GLASS

To ensure the glass is properly located the text 'This side up' should be facing towards you at the top edge of the door and facing into the cavity.

Holding the glass with both hands, gently slide the glass into the side trims of the oven door. Always ensure that the glass is returned to the same side trim it was removed from.

Replace the seal on the main oven door if removed.

To replace the trim, line up the clips on the underside of the trim with the connectors at the top of the door.

Carefully slide the trim towards the door.

Ensure the trim is securely in place before closing the oven door.



Do not attempt to use the oven without the glass being in place.

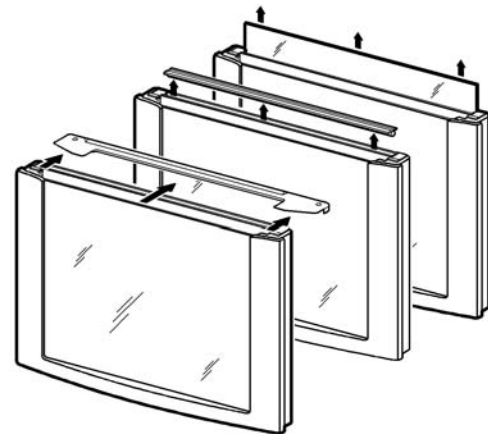
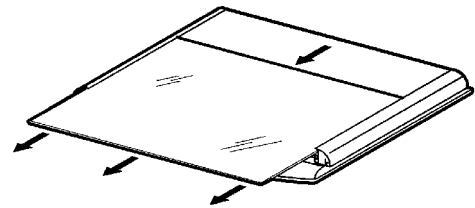
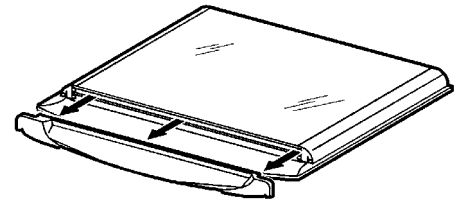

Please note that the door glass on your product may differ in type and shape from that shown in the diagram.

REPLACING AN OVEN LIGHT BULB

The type of bulb required is a 300°C 25 watt small Edison Screw.



Disconnect the appliance from the electricity supply before replacing the bulb.

1. Make sure the appliance is cool before replacing the bulb.
2. Open the door and remove the shelves and wirework runners.
3. Remove the glass cover by turning it to the left.
4. Unscrew the bulb by turning it to the left.
5. Fit a new bulb and then replace the glass bulb cover.
6. Refit the wirework runners and replace the oven shelves.
7. Restore the electricity supply and reset the time of day.

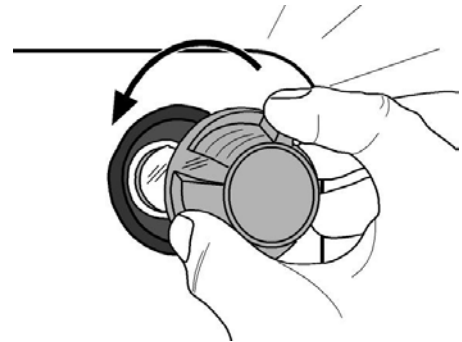

SOMETHING NOT WORKING?

Please carry out the following checks on your appliance before calling a Service Engineer. It may be that the problem is a simple one which you can solve yourself without the expense of a service call.

In-guarantee customers should make sure that the checks have been made as the engineer will make a charge if the fault is not a mechanical or electrical breakdown.

Please note that proof of purchase is required for in-guarantee service calls.

PROBLEM	POSSIBLE SOLUTION
The grill, ovens and timer do not work.	<p>Check that the appliance has been wired in to the appliance supply and is switched on at the wall.</p> <p>Check that the main appliance fuse is working.</p> <p>If you have checked the above: Allow the appliance to cool for a couple of hours. The appliance should now be working normally.</p>
The grill and top oven work but the main oven does not.	<p>Check that the time of day has been set on the clock.</p> <p>Check that the oven is set for manual cooking.</p>
The grill does not work or cuts out after being used for a long period of time.	<p>Ensure the cooling fan is running when the grill is on. If the cooling fan fails, the grill will not operate correctly. Contact your local Service Force Centre.</p> <p>Leave the grill door open and allow the grill to cool. After a couple of hours check that the grill works as normal</p>
The timer does not work.	<p>Check that the instructions for the operation of the timer are being closely followed.</p>
The indicator neons are not working correctly.	<p>Check that you have selected only the function you require. Ensure all other controls are in the Off position.</p>
The oven is not cooking evenly.	<p>Check that the appliance is correctly installed and is level.</p> <p>Check that the recommended temperatures and shelf positions are being used.</p>
The oven light fails to illuminate.	<p>The oven light bulb may need replacing.</p> <p>If the Main Oven is set for automatic cooking the light will illuminate when the cook time begins.</p>
The oven fan is noisy.	<p>Check that the oven is level.</p> <p>Check that the shelves and bakeware are not vibrating in contact with the oven back panel.</p>
The oven temperature is too high or too low.	<p>Check that the recommended temperatures and shelf positions are being used. Be prepared to adjust the temperature up or down by 10°C to achieve the results you want.</p> <p>Refer to the main oven section.</p>

SERVICE AND SPARE PARTS

In the event of your appliance requiring service, or if you wish to purchase spare parts, please contact your local Service Force Centre by telephoning:-

0870 5 929929

Your telephone call will be automatically routed to the Service Force Centre covering your post code area.

For the address of your local Service Force Centre and further information about Service Force, please visit the website at www.serviceforce.co.uk.

Before calling out an engineer, please ensure you have read the details under the heading "Something Not Working?".

When you contact the Service Force Centre you will need to give the following details:

1. Your name, address and post code.
2. Your telephone number.
3. Clear and concise details of the fault.
4. The model and serial number of the appliance (found on the rating plate).
5. The purchase date.

Please note that a valid purchase receipt or guarantee documentation is required for in-guarantee service calls.

For Customer Service in Ireland please contact us at the address below:

Electrolux Group (Irl) Ltd
Long Mile Road
Dublin 12
Republic of Ireland

Tel: +353 (0) 1 4090753

Email: service.eid@electrolux.ie

CUSTOMER CARE DEPARTMENT

For general enquires concerning your Electrolux appliance or for further information on Electrolux products, please contact our Customer Care Department by letter or telephone at the address below or visit our website at www.electrolux.co.uk

Customer Care Department
Electrolux
Major Appliances
Addington Way
Luton
Bedfordshire
LU4 9QQ
Tel: 0870 5 950950 (*)

*calls to this number may be recorded for training purposes.

GUARANTEE CONDITIONS

Standard guarantee conditions

We, Electrolux, undertake that if within 12 months of the date of the purchase this Electrolux appliance or any part thereof is proved to be defective by reason only of faulty workmanship or materials, we will, at our option repair or replace the same FREE OF CHARGE for labour, materials or carriage on condition that:

- The appliance has been correctly installed and used only on the electricity supply stated on the rating plate.
- The appliance has been used for normal domestic purposes only, and in accordance with the manufacturer's instructions.
- The appliance has not been serviced, maintained, repaired, taken apart or tampered with by any person not authorised by us.
- All service work under this guarantee must be undertaken by a Service Force Centre.
- Any appliance or defective part replaced shall become the Company's property.
- This guarantee is in addition to your statutory and other legal rights.

Home visits are made between **8.30am** and **5.30pm** Monday to Friday. Visits may be available outside these hours in which case a **premium** will be charged.

Exclusions

This guarantee does not cover:

- Damage or calls resulting from transportation, improper use or neglect, the replacement of any light bulbs or removable parts of glass or plastic.
- Costs incurred for calls to put right an appliance which is improperly installed or calls to appliances outside the United Kingdom.
- Appliances found to be in use within a commercial environment, plus those which are subject to rental agreements.
- Products of Electrolux manufacture which are not marketed by Electrolux.

European Guarantee

If you should move to another country within Europe then your guarantee moves with you to your new home subject to the following qualifications:

- The guarantee starts from the date you first purchased your product.
- The guarantee is for the same period and to the same extent for labour and parts as exists in the new country of use for this brand or range of products.
- This guarantee relates to you and cannot be transferred to another user.
- Your new home is within the European Community (EC) or European Free Trade Area.
- The product is installed and used in accordance with our instructions and is only used domestically, i.e. a normal household.
- The product is installed taking into account regulations in your new country.

Before you move please contact your nearest Customer Care centre, listed below, to give them details of your new home. They will then ensure that the local Service Organisation is aware of your move and able to look after you and your appliances.

France	Senlis	+33 (0) 3 44 62 20 13
Germany	Nürnberg	+49 (0) 800 234 7378
Italy	Pordernone	+39 (0) 800117511
Sweden	Stockholm	+46 (0) 20 78 77 50
UK	Luton	+44 (0) 8705 950 950
Ireland	Dublin	+353 (0) 1 4090753

TECHNICAL DETAILS

Voltage:	230-240 Volts AC 50Hz
Wattage:	9.5 - 10.3 kW
Height:	900mm
Width:	600mm
Depth: (excluding handles and knobs)	600mm
Weight	68.0kg



This appliance complies with: European Council Directive 73/23/EEC.
EMC Directive 89/336/EEC.
CE Marking Directive 93/68/EEC. Energy Label Directive 2002/40/EC.

INSTALLATION INSTRUCTIONS

WARNING: THIS APPLIANCE MUST BE EARTHED

If your appliance has been damaged in transit, contact your supplier immediately. **Do not** attempt to install it.

Your appliance left the factory fully packaged to protect it from damage. If it is delivered without packaging and damage has occurred, the manufacturer cannot accept responsibility. Contact your supplier for advice.

Once the packaging has been removed the appliance should only be moved by hand. **Do not** use a sack barrow or any other aid to lift the appliance as damage may occur.

Connection to the electricity supply must be carried out by a qualified electrician/competent person.

The electrical connection should be made using a double pole isolating switch (cooker socket) with at least 3mm contact separation in all poles. The cable must have conductors of sufficiently high cross-sectional area to prevent overheating and deterioration.

The recommended cross-section area is six square millimetres (6.00mm²).

When refitting the mains terminal cover, ensure that the lower tabs are located inside the bottom edge of the aperture, before fixing the two screws to the top edge of the mains terminal cover. See Fig.1. Ensure that the cover is securely fastened.

To move the appliance, open the oven door, and lift the appliance by holding inside the top of the compartment. See Fig.2.

This is a type Y appliance, which means it is free-standing and can be fitted with cabinets on one or both sides. It may also be fitted in a corner setting.

Side walls which are above hob level should be protected by heat resistant non-combustible material and **MUST NOT** be nearer than 40mm to the hob side.

A nominal air gap of 2mm at either side of the appliance is required to enable the appliance to be moved into position.

Always ensure an air gap is maintained at hotplate level. Tiles or other forms of deep wall covering should not obscure this gap. See Fig.3.

Overhanging surfaces or a cooker hood should be a minimum of 685mm above the hob. See Fig.4.

It is important to ensure that the appliance is level after installation. Levelling feet are fitted to the appliance to accommodate uneven floors.

Fig.1.

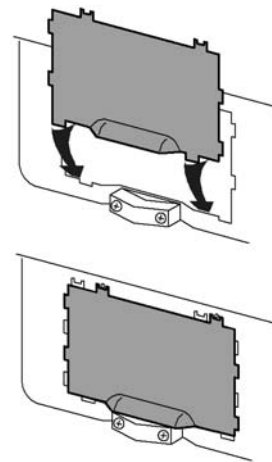

Fig.2.

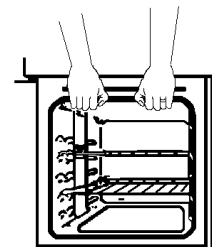

Fig.3.

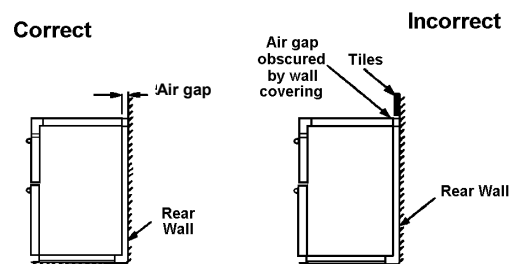
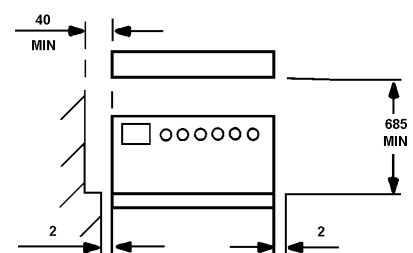

Fig.4.



CONNECTING TO THE ELECTRICITY SUPPLY



**Warning: This appliance must be earthed.
Do not earth this appliance to the gas
supply piping.
Connect to 230 - 240V AC supply only.**

- The electrical connection should be made using a double pole isolating switch (cooker socket) with at least 3mm contact separation in all poles. The cable must have conductors of sufficiently high cross-sectional area to prevent overheating and deterioration.
- We recommend you use a new length of 6mm² twin core and earthed cable to ensure your safety.
- Make connection as shown in Fig 5 by proceeding as follows:-
- Preform wires to the appropriate shape to suit fitting into the mains terminal block.
- Strip inner insulation on wires using wire strippers.
- Twist the bared wires using pliers.
- Cut bared wires 10mm away from the end of the inner insulation. Where uninsulated Earth wires are used ensure they are suitably sheathed to leave 10mm bare wire to fit into the terminal.
- Clamp bare wires into the relevant terminal (Fig. 5.) and check they are held by tugging each one in turn.
- Ensure **all** screws are securely tightened.
- Clamp the mains cable securely ensuring 5mm of the outer insulation is inside the terminal block and that the wires are not taut but not so slack as to cause any fouling.
- Connect the remaining end of the mains cable to the appliance to the appliance point / junction box.
- Place fuse / miniature circuit breaker in circuit and switch on at mains.

NOTE: HOUSE CIRCUIT

Earth leakage / continuity tests must be carried out before the appliance is connected to the mains supply and re-checked after fitting.

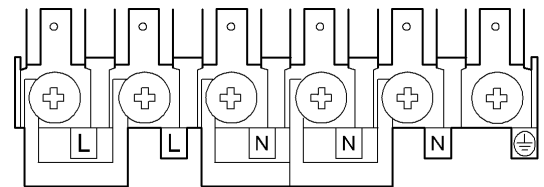

Fig.5.

**ENSURE THAT THE LINKS ARE FITTED
AS SHOWN IN FIG.5.**

NOTES

NOTES

NOTES

IMPORTANT NOTICE

In line with our continuing policy of research and development, we reserve the right to alter models and specifications without prior notice.

This instruction booklet is accurate at the date of printing, but will be superseded if specifications or appearance are changed.

**ELECTROLUX
MAJOR APPLIANCES,
ADDINGTON WAY,
LUTON,
BEDFORDSHIRE
LU4 9QQ.
TELEPHONE 0870 5 950950**

To buy accessories, consumables and spare parts at our online shop please visit:
<http://www.electrolux.co.uk>

Part Number: 349095802