

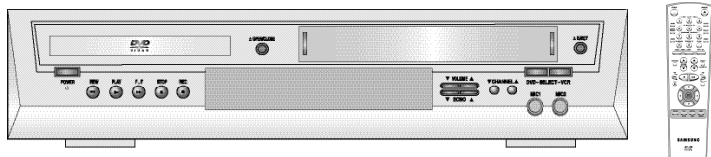

DVD-V85K

# Instruction Manual



**DVD**  
VIDEO **VHS** **Hi-Fi**

**WARNING:**

TO PREVENT DAMAGE WHICH MAY RESULT IN FIRE OR ELECTRIC SHOCK HAZARD, DO NOT EXPOSE THIS APPLIANCE TO RAIN OR MOISTURE.

**WARNING:**

TO AVOID HAZARDOUS EXPOSURE TO INVISIBLE LASER RADIATION, DO NOT OPEN OR REMOVE/DEFEAT LASER TRANSPORT PROTECTIVE HOUSING.

**USER/INSTALLER CAUTION:**

Your authority to operate this FCC certified equipment could be voided if you make changes or modifications not expressly approved by the manufacturer, who is responsible for compliance with Part 15 FCC rules.

**NOTE TO CATV SYSTEM INSTALLER:**

This reminder is provided to call the CATV system installer's attention to Article 820-40 of the National Electronic Code that provides guidelines for proper grounding and, in particular, specifies that the cable ground shall be connected to the grounding system of the building, as close to the point of cable entry as practical.



This symbol is intended to alert the user to the presence of uninsulated dangerous voltage within the product's enclosure that may be of sufficient magnitude to constitute risk of fire or electric shock.



This symbol is intended to alert the user to the presence of important operating and maintenance instructions in the literature accompanying this product.

**Copy Notification**

Federal law provides severe civil and criminal penalties for the unauthorized reproduction, distribution, or exhibition of copyrighted motion pictures and videotapes. (Title 17, United States Code, Sections 501 and 506).

**Macrovision Notification**

This product incorporates copyright protection technology that is protected by method claims of certain U.S. patents and other intellectual property rights owned by Macrovision Corporation and other rights owners. Use of this copyright protection technology must be authorized by Macrovision Corporation, and is intended for home and other limited viewing uses only unless otherwise authorized by Macrovision Corporation. Reverse engineering or disassembly is prohibited.

**CAUTION:**

To prevent fire, shock hazard, or annoying interference, use only the recommended accessories. To prevent electric shock, do not use this (polarized) plug with an extension cord, receptacle, or other outlet unless the blades can be fully inserted to prevent blade exposure. To reduce the risk of electric shock, do not remove the unit cover or back. There are no serviceable parts inside. Refer servicing to qualified personnel only.

**CUIDADO:**

Para prevenir incendio, riesgo de choque, o interferencia enfadosa, use solamente los accesorios recomendados. Para prevenir electrochoque, no use este enchufe (polarizado) con un cordón de extensión, toma de corriente, o cualquier otra toma a menos que los dientes puedan ser completamente insertados para prevenir exposición de los dientes. Para reducir el riesgo de descarga eléctrica, no remueva la cubierta o la parte posterior del equipo. Dentro del equipo no hay partes que requieran servicio. Dirijase solamente a personal calificado cuando requiera servicio.

**ATTENTION:**

Pour éviter les incendis, risque de chocs, ou interférences fâcheuses, employer seulement les accessoires recommandés. Pour éviter les chocs électriques, ne pas employer cette prise (polarisée) avec une rallonge, une prise de courant ou une autre sortie de courant à moins que les lames peuvent être insérées à fond pour l'exposition des lames. Pour réduire les risques de chocs électriques, ne pas retirer le couvercle ou l'arrière du module. Il n'y a pas de pièce utilisable à l'intérieur. Ne faire effectuer l'entretien que par un personnel qualifié.

**Important Safety Instructions**

1. Read these instructions.
2. Keep these instructions.
3. Heed all warnings.
4. Follow all instructions.
5. Do not use this apparatus near water.
6. Clean only with dry cloth.
7. Do not block any ventilation openings. Install in accordance with the manufacturer's instructions.
8. Do not install near any heat sources such as radiators, heat registers, or other apparatus (including amplifiers) that produce heat.
9. Do not defeat the safety purpose of the polarized or grounding-type plug. A polarized plug has two blades with one wider than the other. A grounding type plug has two blades and a third grounding prong. The wide blade or the third prong are provided for your safety. If the provided plug does not fit into your outlet, consult an electrician for replacement of the obsolete outlet.
10. Protect the power cord from being from being walked on or pinched particularly at plugs, convenience receptacles, and the point where they exit from the apparatus.
11. Only use attachments/accessories specified by the manufacturer.
12. Use only with cart, stand, tripod, bracket, or table specified by the manufacturer, or sold with the apparatus. When a used, caution when moving the cart/apparatus combination to avoid injury from tip-over.
13. Unplug this apparatus. When a cart is used, use caution when moving the cart/apparatus combination to avoid injury from tip-over.
14. Refer all servicing to qualified service personnel. Servicing is required when the apparatus has been damaged in any way, such as power-supply cord or plug is damaged, liquid has been spilled or objects have fallen into the apparatus, the apparatus has been exposed to rain or moisture, does not operate normally, or been dropped.

## Table of Contents

◆ Safety	
■ Important Safety Instructions	3
◆ Welcome	
■ Feature Summary	6
■ Unpacking	6
■ Disc Type and Characteristics	7
◆ 1 - System Overview	
■ Front Panel Overview	8
■ Rear Panel	8
■ Front Panel Display	9
■ Remote Control Overview	10
■ Insert Remote Control Batteries	10
◆ 2 - Getting Started	
■ Basic Connections	11
◆ 3 - Basic Operation	
■ Deck Control Buttons	12
■ Basic DVD Playback	12
■ Basic VHS Playback	13
■ Basic TV Tuner Operations	14
◆ 4 - System Setup	
■ On-Screen Menu Navigation	14
■ Menu Language	15
■ Manual Clock Set	16
■ Tuner Band Setting	17
■ Auto Channel Memory	18
■ Channel Add/Delete	19
■ RF Output Channel	20
■ Front Panel Dimmer	20
■ Auto Power Off	21
◆ 5 - DVD Setup	
■ Disc Menu Language	22
■ Audio Language	22
■ Subtitle Language	23
■ Parental	24
■ Digital Output	25
■ DTS	26
■ Dynamic Compression	27
■ TV Aspect Ratio	28
■ Black Level	29
■ Alt Video Out	29
◆ 6 - DVD Sound Setup	
■ A/V Receiver Connections	30

## Table of Contents

◆ 7 - DVD Operations	
■ Special Playback Features	31
■ Disc Menu Navigation	32
■ Screen Fit Playback	32
■ Title/Chapter/Time Selection	33
■ Zoom	34
■ Angle	34
■ Subtitle	35
■ Digest Playback	35
■ A-B Repeat	36
■ Repeat Chapter/Title	37
■ Audio	37
■ Bookmarks	38
■ Programmed Playback	39
■ Random Playback	40
■ MP3 Playback	40
■ 3D Sound	41
◆ 8 - VCR Playback	
■ Special VCR Playback Features	42
■ Tracking	42
■ Auto Play	43
■ S-VHS Playback	43
■ Variable Search System	44
◆ 9 - VCR Recording	
■ Basic Recording	45
■ Special Recording Features	46
■ One-Touch Recording (OTR)	47
■ Record Speed	47
◆ 10 - Timer Recording	
■ How to Set a Timer Recording	48
◆ 11 - KARAOKE Functions (VCR)	
■ Using the KARAOKE Function	49
■ SCORE Function	49
■ KARAOKE SEARCH Function	49
◆ 12 - KARAOKE Functions (DVD)	
■ Beginning Karaoke Functions	50
■ Key Control	50
■ Reserving a Song	51
■ Cancellation of reservation	51
■ Vocal Fader	52
■ Guide Melody	52
■ Score Function	52
■ Types of Karaoke disc	52
◆ Appendix A - Advanced Connections	
■ S-Video/Component Video Connections (for DVD)	53
■ Stereo Connections	54
■ Monitor TV Connections	55
■ Connecting Other Video Equipment	56
◆ Appendix B - Help	
■ Technical Specifications	57

## Feature Summary

### System Features

- Complete versatility to play DVD, VCDs, audio CDs, MP3 discs or VHS Tapes.
- Watch a DVD while recording a TV show to the VCR.
- Remote controls both DVD and VCR decks.
- Composite, S-Video and Component video outputs for high connectivity and optimum performance.
- RF inputs and outputs for connection to all TVs—new or old.
- English/French/Spanish on-screen programming.

### DVD Features

- 10-bit video digital to analog converter and 27MHz advanced digital filter.
- Playback of 96KHz/24-bit sources.
- DTS digital output for DTS-enhanced DVDs.
- Playback MP3 files from CD-ROM.
- Continued audio during 2x speed playback.

### VCR Features

- Hi-Fi Stereo VCR.
- 4 heads for superior slow motion and stop action.
- Playback of S-VHS tapes at better than standard resolution.
- VISS Index Search/Scan, Zero Return, Blank Search.
- 8-event/1 month timer recording.
- Time remaining counter, real time counter.

### Note

\*Discs which cannot be played with this player.

- DVD-ROM
- DVD-RAM
- CD-ROM
- CDV
- CDI
- HD layer of super Audio CD
- CDGs play audio only, not graphics.

\*Ability to play back may depend on recording conditions.

- DVD-R
- CD-RW
- DVD+RW, -RW

## Unpacking

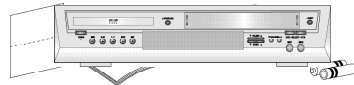

*As you unpack, please check that the following items are included in your DVD-VCR packing case:*

- DVD-VCR
- User's Guide
- RCA cable for Audio/Video connection
- RF (Radio Frequency) Antenna Cable
- Remote Control
- 1.5V "AA" Batteries - 2EA



## Disc Type and Characteristics

This DVD player is capable of playing the following types of discs with the corresponding logos:

Disc Types (Logos)	Recording Types	Disc Size	Max. Playing Time	Characteristics
	Audio + Video	5"	Single-sided 240 min. Double-sided 480 min.	<ul style="list-style-type: none"> <li>• DVD contains excellent sound and video due to Dolby Digital and MPEG-2 system.</li> <li>• Various screen and audio functions can be easily selected through the on-screen menu.</li> </ul>
		3 1/2"	Single-sided 80 min. Double-sided 160 min.	
	Audio + Video	5"	74 min.	<ul style="list-style-type: none"> <li>• Video with CD sound, VHS quality &amp; MPEG-1 compression technology.</li> </ul>
		3 1/2"	20 min.	
	Audio	5"	74 min.	<ul style="list-style-type: none"> <li>• CD is recorded as a Digital Signal with better audio quality, less distortion and less deterioration of audio quality over time.</li> </ul>
		3 1/2"	20 min.	

### Disc Markings



- Play Region Number
- NTSC broadcast system in U.S.A, Canada, Korea, Japan, etc.
- Dolby Digital disc
- Stereo disc
- Digital Audio disc
- DTS disc
- MP3 disc

### Play Region Number

Both the DVD player and the discs are coded by region. These regional codes must match in order for the disc to play. If the codes do not match, the disc will not play.

**The Region Number for this player is described on the rear panel of the player.**

## Front Panel Overview

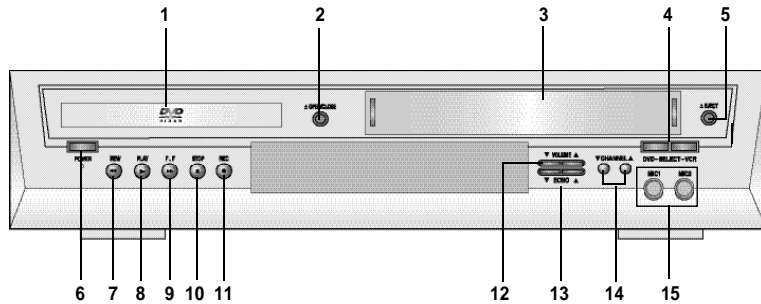

- |                    |                |
|--------------------|----------------|
| 1 DVD DECK         | 11 RECORD      |
| 2 DVD OPEN/CLOSE   | 12 VOLUME ▲/▼  |
| 3 VCR DECK         | 13 ECHO ▲/▼    |
| 4 DVD-VCR SELECT   | 14 CHANNEL ▲/▼ |
| 5 EJECT            | 15 MIC         |
| 6 POWER            |                |
| 7 REWIND/REV       |                |
| 8 PLAY/PAUSE       |                |
| 9 FAST-FORWARD/FWD |                |
| 10 STOP            |                |

## Rear Panel

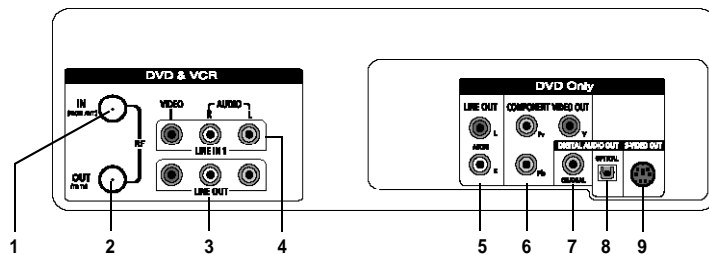

- |  |                              |
|--|------------------------------|
| 1 RF ANTENNA INPUT                               | 6 COMPONENT VIDEO OUT        |
| 2 RF OUT TO TV                                   | 7 DIGITAL AUDIO OUT(COAXIAL) |
| 3 LINE OUT TO TV (COMPOSITE)                     | 8 DIGITAL AUDIO OUT(OPTICAL) |
| 4 LINE IN 1                                      | 9 S-VIDEO OUT                |
| 5 AUDIO LINE OUT TO TV<br>(S-VIDEO OR COMPONENT) |                              |

8

## Front Panel Display

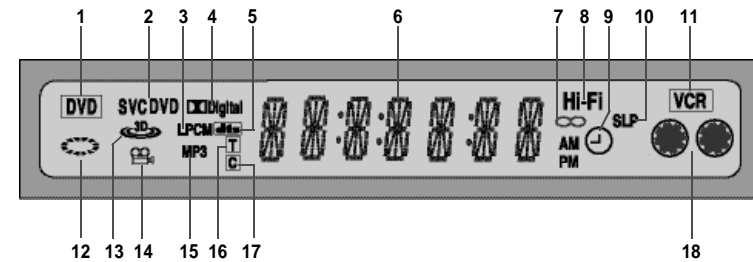

- |  |  |
|--|--|
| 1 The DVD Deck is selected   | 11 The VCR Deck is selected  |
| 2 A DVD, CD, VCD or SVCD is loaded   | 12 The status of the DVD deck is graphically displayed                     |
| 3 A disc with LPCM (Linear Pulse Code Modulation) audio is loaded                | 13 3D Sound is active  |
| 4 A DVD with a Dolby Digital is loaded   | 14 The DVD has multiple angles to choose from                              |
| 5 A DVD with a DTS soundtrack is loaded  | 15 MP3   |
| 6 The time, counter position, time remaining or current deck status is displayed | 16 The number to the right of the "T" symbol is the current title number   |
| 7 The current TV show or video is broadcast in Stereo                            | 17 The number to the right of the "C" symbol is the current chapter number |
| 8 The Hi-Fi track of a VHS tape is playing                                       | 18 VHS tape is inserted and the VCR Deck is active                         |
| 9 A Timer Recording is programmed or in progress. If blinking there is an error. |  |
| 10 Tape Speed  |  |

9

## Remote Control Overview

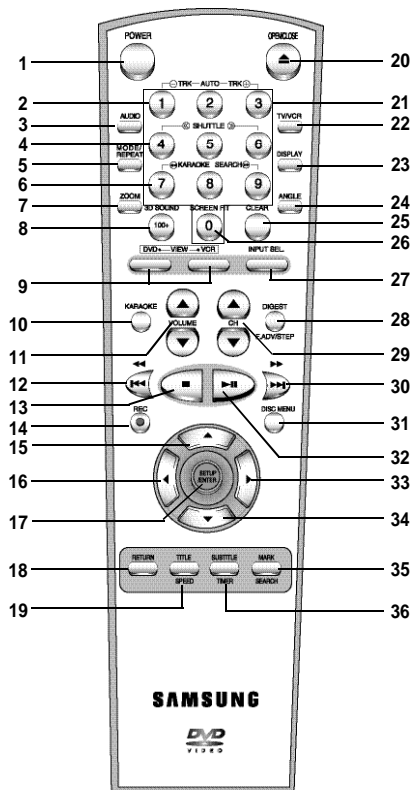

- 1 POWER
- 2 AUTO TRACKING/TRACKING +/-
- 3 AUDIO
- 4 SHUTTLE <</>
- 5 MODE, REPEAT
- 6 KARAOKE SEARCH <<>>
- 7 ZOOM
- 8 3D SOUND/100+
- 9 DVD, VCR
- 10 KARAOKE
- 11 VOLUME ▲/▼
- 12 REWIND, SKIP BACK
- 13 STOP
- 14 RECORD
- 15 UP
- 16 LEFT
- 17 SETUP/ENTER
- 18 RETURN
- 19 TITLE, SPEED
- 20 OPEN/CLOSE
- 21 0-9
- 22 TV/VCR
- 23 DISPLAY
- 24 ANGLE
- 25 CLEAR
- 26 SCREEN FIT
- 27 INPUT SEL.
- 28 DIGEST, F.ADV/STEP
- 29 CH ▲/▼
- 30 FAST-FORWARD
- 31 DISC MENU
- 32 PLAY/PAUSE
- 33 RIGHT
- 34 DOWN
- 35 MARK, SEARCH
- 36 SUBTITLE, TIMER

## Insert Remote Control Batteries

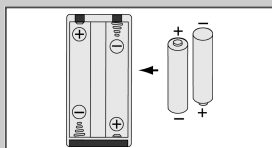

10

- Remove the battery cover by pushing down on the thumb tab and sliding the cover.
- Insert two 1.5V "AA" batteries as shown, paying attention to the correct polarities (+/-).
- When finished, slide the cover until it clicks back into place.

## Basic Connections

In this section, you will connect the DVD-VCR to your television.

### NOTES:

- Advanced Connections are covered in Appendix A.
- Even if you plan to use the S-Video or Component Video Outputs, you **MUST** connect the DVD-VCR to your television with either the standard RF or the Line Out connection. This enables you to operate the DVD-VCR setup menus.



### 1 Connect Antenna/Cable to DVD-VCR

Connect the RF antenna cable from your indoor/outdoor antenna or cable wall outlet to the IN (FROM ANT.) jack on the back panel of the DVD-VCR.

### 2 Connect DVD-VCR to TV

Choose one of the following methods to connect the DVD-VCR to your TV:

#### RF Connection

Connect the supplied RF antenna cable from the OUT (TO TV) jack on the back panel of the DVD-VCR to your television's Antenna Input.

NOTE : Check the channel to connect DVD-VCR to your television's Antenna Input; See page 20.

#### Line Connection

Connect an RCA-type audio/video cable (red, white, yellow) from the LINE OUT jacks on the back panel of the DVD-VCR to your television's Line In jacks. Use red for right audio, white for left audio, and yellow for video.

NOTE: It is recommended that you use the Line Connection if your TV is equipped with RCA jacks.

### 3 Plug In DVD-VCR

Connect the DVD-VCR power cord to wall outlet. Don't press any buttons on the DVD-VCR or remote during auto setup. "AUTO" blinks while the DVD-VCR runs an auto setup procedure, where it will automatically search for all active channels.

### 4 Turn On DVD-VCR

Press the POWER button on the remote control or on the DVD-VCR's front panel.

### 5 Turn On TV

Press the POWER button on your TV.

### 6 Set TV to Channel 3, 4 or Line

Be sure to use the same channel you selected in Step 2. If you used the Line Connection, set your TV to its Line Input.

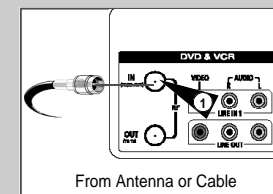

From Antenna or Cable

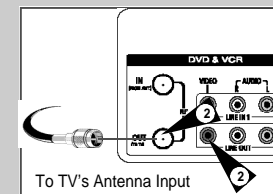

To TV's Antenna Input

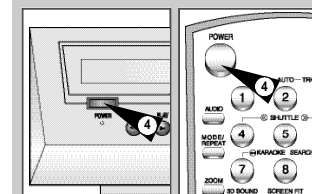

11

## Deck Control Buttons

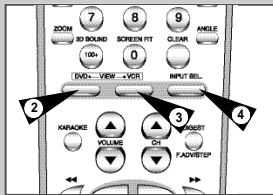
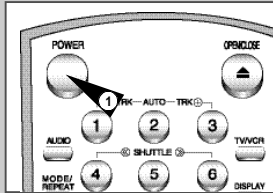

The DVD-VCR uses one set of controls to operate both decks. The following buttons are helpful in successfully controlling each deck.

- 1 POWER Button**  
Press the POWER button on the remote control or front panel to turn on the DVD-VCR.
- 2 DVD Button**  
Press the DVD button on the remote control or front panel when you want to control the DVD deck.
  - The DVD indicator will light on the Front Panel Display to show that the DVD deck is selected.
- 3 VCR Button**  
Press the VCR button on the remote control or front panel when you want to control the VCR deck.
  - The VCR indicator will light on the Front Panel Display to show that the VHS deck is selected.
- 4 INPUT SEL. Button**  
Press the INPUT SEL. button repeatedly to cycle through all of your input sources, including the Tuner (Ch##), Line 1 (rear AV input).
  - It is only available when VCR deck is selected.

## Basic DVD Playback

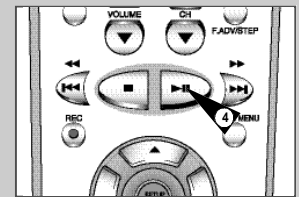
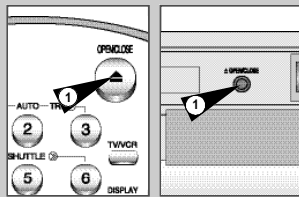

Follow these instructions to playback a DVD.

- 1 Open Disc Drawer**  
Press the OPEN/CLOSE button on the remote control or front panel to automatically power on the DVD-VCR and open the disc drawer.
- 2 Insert Disc**  
Place the disc in the drawer with the label side of the disc facing up. If the disc has two sides, orient the disc with the desired label facing up.
- 3 Close Disc Drawer**  
Press the OPEN/CLOSE button on the remote control or front panel to close the disc drawer.
- 4 Play the DVD**  
Press the ►|| (Play/Pause) button on the remote control or front panel.
  - Many discs will begin playback automatically when the disc drawer closes.
  - If the DVD has a disc menu, or more than one title, the disc menu may appear.
- 5 Additional DVD Options**
  - For advanced DVD Setup options, see pages 22-29.
  - For special DVD Playback features, see pages 31-41.

## Basic VHS Playback

To play a videotape, simply insert it in the VHS deck and press the Play button. Tapes without Record Safety Tabs can be set to play automatically when inserted; see page 43.

- 1 Insert VHS Tape**  
Insert a standard VHS videotape into the VHS Deck.
  - Power will turn on automatically when you insert a videotape.
- 2 Play Tape**  
Press the ►|| (Play/Pause) button on the remote control or front panel. If the tape is missing the Record Safety Tab and Auto Play is turned on, the tape will begin to play automatically, see page 43.
- 3 Stop Playback**  
Press the ■ (Stop) button on the remote control or front panel.
- 4 Eject Tape**  
Press the OPEN/CLOSE button on the remote control or the EJECT button on the front panel.
- 5 Additional VCR Options**
  - For special VCR Playback features, see pages 42-43.
  - For VCR Recording features, see pages 45-47.
  - For Timer Recording features, see page 48.

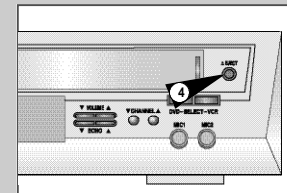
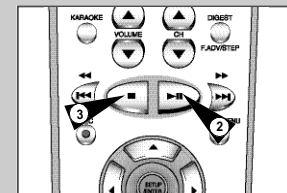
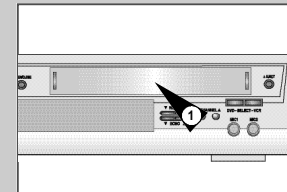
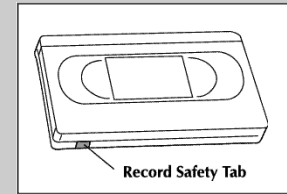

## Basic TV Tuner Operations

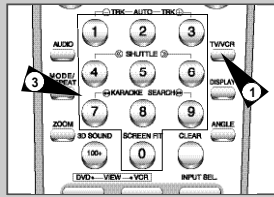

The following buttons are used when watching television via the DVD-VCR's built-in TV tuner.

- 1 TV/VCR**  
Press to switch between your TV's tuner and the VCR's internal tuner.
- 2 Channel Up/Down**  
Press to change to the next or previous channel.
- 3 0-9 Buttons**  
Press to select channels directly.
- 4 100+ Button**  
Press to select channels 100 and higher. First, press the 100+ button, then press the remaining digits using the 0-9 buttons.
- 5 Display**  
Press to display the channel you are watching.
  - Also works in DVD and VCR mode.

## On-Screen Menu Navigation

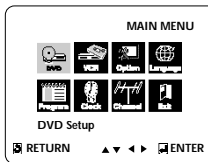

The Setup Menu is the opening screen of the on-screen menu system

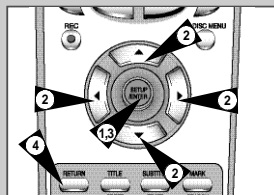

The on-screen menu system allows you to set all functions for your DVD-VCR. The following buttons are used to open and navigate through the on-screen menu system.

- 1 SETUP Button**  
With the DVD in stop mode, press to access the DVD-VCR on-screen menu system.
- 2 Up/Down and Left/Right**  
Moves menu selection cursor up, down, left and right to cycle through menu options
- 3 ENTER Button**  
Press to confirm settings in certain menus.
- 4 RETURN Button**  
Returns to the last menu viewed or exits the menu system.

## Menu Language

Follow these steps to change the on-screen menu language to English, French or Spanish.

- 1 Open "SETUP MENU"**  
With the DVD in stop mode, press the SETUP button.
- 2 Set "Language"**  
Using the Up/Down and Left/Right buttons, move the selection arrow to "Language/Idioma/Langue," then press ENTER button.
- 3 Set menu Language**  
Move the selection bar to your desired Language, then press ENTER button.

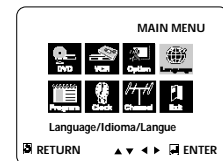
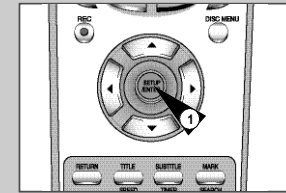

### LANGUAGE/IDIOMA/LANGUE

► English  
Español  
Français

RETURN ENTER

English Setup Menu



French/Spanish Setup Menu



## Manual Clock Set

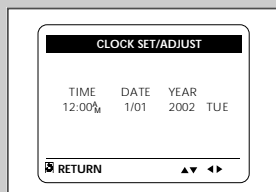
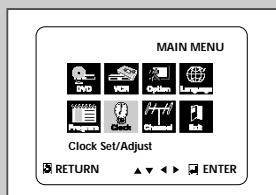
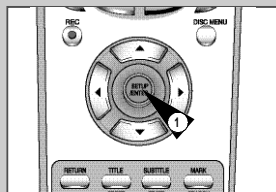

*It is important to set the clock for accurate Timer Recording.*

- 1 **Open "SETUP MENU"**  
With the DVD in stop mode, press the SETUP button.
- 2 **Select "Clock"**  
Using the up/down and left/right buttons, move the selection cursor to "Clock Set/Adjust," then press ENTER to select.
- 3 **Set the Clock**  
Press LEFT/RIGHT to select each of the following options, then press UP/DOWN to set each option:
  - **Set Hour** – Set the hour using the up and down buttons.
  - **Set Minute** – Set the minute using the up and down buttons.
  - **Set Month** – Set the month using the up and down buttons.
  - **Set Day** – Set the day using the up and down buttons.
  - **Set Year** – Set the year using the up and down buttons.
- 4 **Confirm Settings**  
Press the RETURN button to save your clock settings and return to the Setup menu.
  - Press Return again to exit.

## Tuner Band Setting

*This feature allows you to manually set the DVD-VCR's tuner band to Antenna or Cable, whichever you connected to the Antenna In jack during initial setup.*

- 1 **Open "SETUP MENU"**  
With the DVD in stop mode, press the SETUP button.
- 2 **Select "Channel"**  
Using the up/down and left/right buttons, move the selection cursor to "Channel Setup", then press ENTER to select.
- 3 **Select "Ant/Cable"**  
Move the selection arrow to "Ant/Cable" then press right to select from the following options:
  - Antenna - Indicates that the DVD-VCR is connected to an indoor or outdoor VHF/UHF antenna.
  - Cable TV - Indicates that the DVD-VCR is connected to Cable TV.

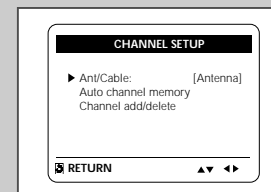
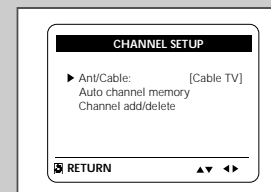
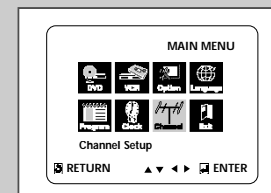
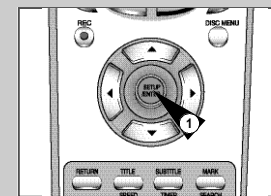

## Auto Channel Memory

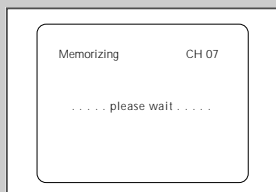
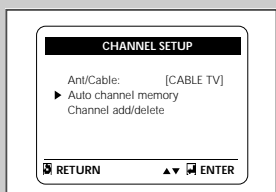
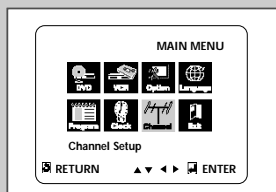
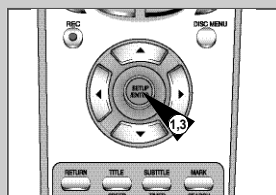

*Auto Channel Memory will automatically seek and store all active channels in your area.*

- 1 Open "SETUP MENU"**  
With the DVD in stop mode, press the SETUP button.
- 2 Select "Channel"**  
Using the up/down and left/right buttons, move the selection cursor to "Channel Setup", then press ENTER to select.
- 3 Run "Auto channel memory"**  
Move the selection arrow to "Auto channel memory," then press ENTER to select.
  - The DVD-VCR will automatically search for all available channels in the selected Tuner Band. This procedure may take a few minutes to complete.
  - When finished, the lowest channel found will be displayed.

## Channel Add/Delete

*Use this feature if Auto Channel Search missed a channel that you would like to add, or added a channel you wish to remove.*

- 1 Open "SETUP MENU"**  
With the DVD in stop mode, press the SETUP button.
- 2 Select "Channel"**  
Using the up/down and left/right buttons, move the selection cursor to "Channel Setup", then press ENTER to select.
- 3 Select "Channel add/delete"**  
Move the selection bar to "Channel add/delete," then press ENTER to select.
- 4 Select Channel to add/delete**  
Use the CH ▲/▼ buttons to tune in the channel number you wish to add or remove.
  - Repeat steps 4 and 5 to add or remove additional channels.
- 5 Select "CHANNEL ADD/DELETE"**  
Press right to add or press left to remove the channel from your channel list.

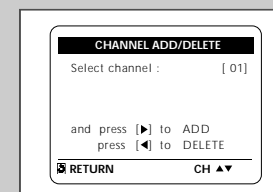
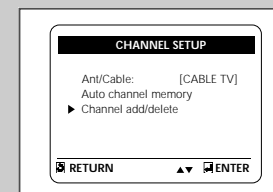
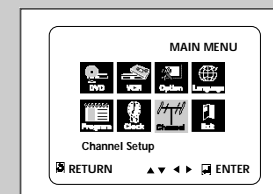
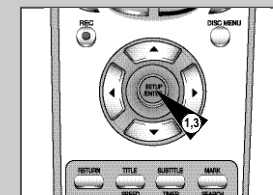

## RF Output Channel

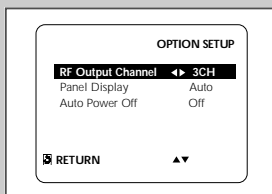
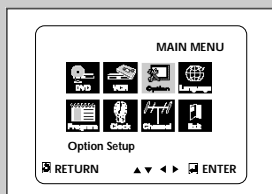

- 1 Open "SETUP MENU"**  
With the DVD in stop mode, press the SETUP button.
- 2 Select "Option"**  
Using the up/down and left/right buttons, move the selection cursor to "Option Setup," then press ENTER to select.
- 3 Select "RF Output Channel"**  
Move the selection bar to "RF Output Channel", then press right to change.
- 4 Change "RF Output Channel"**  
Press Return to change. A message will appear on your TV. Then press ENTER to change.
- 5 Change "TV Channel"**  
A message will appear on your TV. When the message disappears, change your TV to channel 3 or 4 to match the RF output channel of the player.

## Front Panel Dimmer

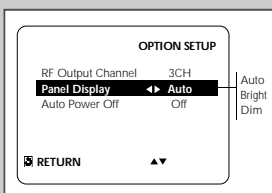
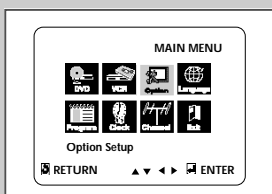

*You can set the Front Panel Display to be bright all the time, dim all the time, dim during power off.*

- 1 Open "SETUP MENU"**  
With the DVD in stop mode, press the SETUP button.
- 2 Select "Option"**  
Using the up/down and left/right buttons, move the selection cursor to "Option Setup," then press ENTER to select.
- 3 Set "Panel Display"**  
Move the selection bar to "Panel Display," then press right to select from the following options:
  - Auto – Front Panel Display will dim automatically during power off.
  - Bright – Front Panel Display will be bright all the time.
  - Dim – Front Panel Display will be dim all the time.

## Auto Power Off

- 1 Open "SETUP MENU"**  
With the DVD in stop mode, press the SETUP button.
- 2 Select "Option"**  
Using the up/down and left/right buttons, move the selection cursor to "Option Setup," then press ENTER to select.
- 3 Select "Auto Power Off"**  
Move the selection bar to "Option Setup", then press right to select from following options:
  - Off – Auto power off is disabled.
  - 1Hr – DVD-VCR will auto shut off 1 hour after the last button is pressed.
  - 2Hr – DVD-VCR will auto shut off 2 hours after the last button is pressed.

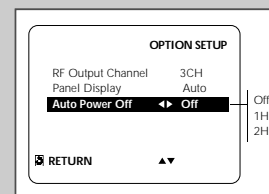
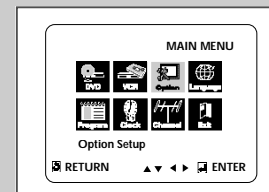

## Disc Menu Language

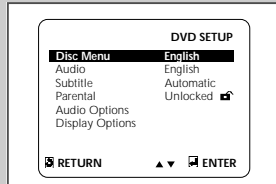
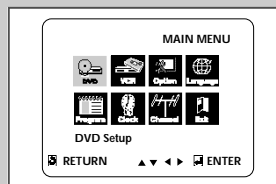

Follow these steps to choose your preferred language for DVD disc menus. The DVD-VCR will automatically default to the language you choose if it is available on a given DVD.

- 1 Open "SETUP MENU"**  
With the DVD in stop mode, press the SETUP button.
- 2 Select "DVD"**  
Using the up/down and left/right buttons, move the selection cursor to "DVD Setup," then press ENTER to select.
- 3 Select "Disc Menu"**  
Move the selection bar to "Disc Menu," then press ENTER to select.
- 4 Set "Disc Menu Language" Preference**  
Move the selection bar to your preferred language for DVD disc menus, then press ENTER to select.

## Audio Language

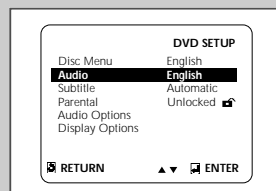

Follow these steps to choose your preferred language for DVD audio soundtracks. The DVD-VCR will automatically default to the language you choose if it is available on a given DVD.

- 1 Open "SETUP MENU"**  
With the DVD in stop mode, press the SETUP button.
- 2 Select "DVD"**  
Using the up/down and left/right buttons, move the selection cursor to "DVD Setup," then press ENTER to select.
- 3 Select "Audio"**  
Move the selection bar to "Audio," then press ENTER to select.
- 4 Set "Audio Language" Preference**  
Move the selection bar to your preferred language for DVD audio soundtracks, then press ENTER to select.

## Subtitle Language

Follow these steps to choose your preferred language for DVD subtitles. The DVD-VCR will automatically default to the language you choose if it is available on a given DVD.

- 1 Open "SETUP MENU"**  
With the DVD in stop mode, press the SETUP button.
- 2 Select "DVD"**  
Using the up/down and left/right buttons, move the selection cursor to "DVD Setup," then press ENTER to select.
- 3 Select "Subtitle"**  
Move the selection bar to "Subtitle," then press ENTER to select.
- 4 Set "Subtitle Language" Preference**  
Move the selection bar to your preferred language for DVD subtitles, then press ENTER to select.

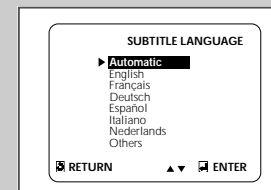
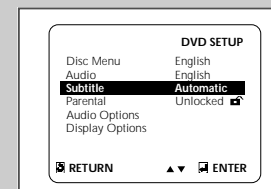
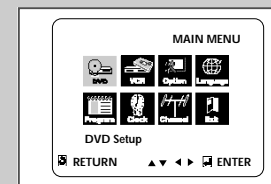

## Parental

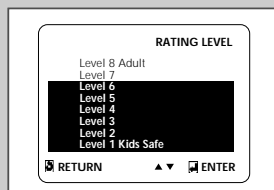
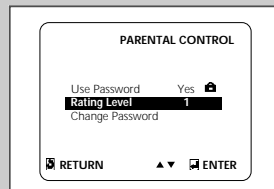
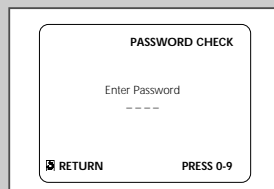
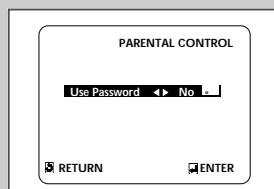
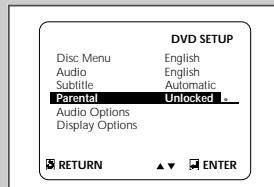
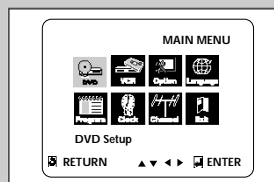

*Rating Control is a password protected system that allows you to block playback of DVDs based on their content. The system uses an eight level rating system.*

- If you try to play a DVD that exceeds the selected rating, an error message will appear.
- Not all discs are rated.

### 1 Open "SETUP MENU"

With the DVD in stop mode, press the SETUP button.

### 2 Select "DVD"

Using the up/down and left/right buttons, move the selection cursor to "DVD Setup," then press ENTER to select.

### 3 Select "Parental"

Move the selection bar to "Parental," then press ENTER to select.

### 4 Select "Use Password"

Move the selection arrow to "Use Password," then press the right button to select from the following options:

- No - Indicates that no password is required to view any DVD disc or to change Rating Control options. No additional Rating Control settings are necessary.
- Yes - Indicates that a password is required to view some DVD discs and to view Rating Control options. The menu will change as shown.

#### NOTES:

- The first time "Require Password" is set to "Yes," you will be prompted to enter a new password.
- If the "Enter Password" screen appears, then "Require Password" has already been set to "Yes." Please skip to Step 5.

### 5 Enter Password

Enter a 4-digit password using the 0-9 buttons on the remote control.

- Write your password down, and keep it in a safe place in case you need it to change your settings later.

### 6 Select "Rating Level"

Move the selection bar to "Rating Level," then press ENTER to select.

### 7 Change Rating Level

Use the up/down to select one of the following ratings:

- Level 8 Adult
- Level 7
- Level 6
- Level 5
- Level 4
- Level 3
- Level 2
- Level 1 Kids Safe

All ratings above the level you select will also be blocked, e.g., if you block Level 6, then Levels 7 and 8 will also be blocked. Press ENTER to confirm your selection.

- If you forgot your password, press power on from a cold start with no disc in the unit. Press the REW and F.F buttons simultaneously on the front panel for 5 seconds. The "reset ok" message will appear. Press the power button.

## Digital Output

*If your A/V receiver is equipped with a Dolby Digital decoder, your DVD-VCR can output Dolby Digital 5.1 sound, but you MUST enable this feature in the menu system to prevent damage to your speakers.*

**NOTE:** Select "Bitstream" ONLY if you have connected a Dolby Digital-equipped A/V receiver to the Digital Output (optical or coaxial) on the DVD-VCR back panel.

### 1 Open "SETUP MENU"

With the DVD in stop mode, press the SETUP button.

### 2 Select "DVD"

Using the up/down and left/right buttons, move the selection cursor to "DVD Setup," then press ENTER to select.

### 3 Select "Audio Options"

Move the selection bar to "Audio Options," then press ENTER to select.

### 4 Set "Digital Output"

Move the selection bar to "Digital Output" then press the right button to select from the following options:

- PCM - To use your DVD/TV with an A/V receiver NOT equipped with a Dolby Digital decoder.
- Bitstream - To use your DVD/TV with an A/V receiver equipped with a Dolby Digital decoder.

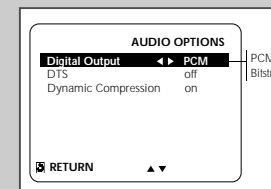
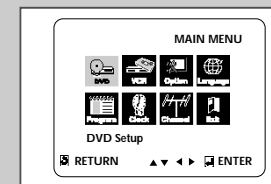

## DTS

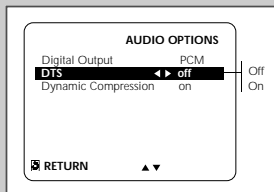
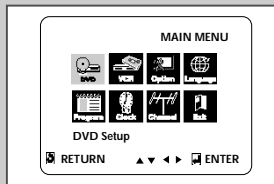

If your A/V receiver is equipped with a DTS decoder, your DVD-VCR can output DTS digital sound, but you **MUST** enable this feature in the menu system.

**NOTE:** Select "On" **ONLY** if you have connected a DTS-equipped A/V receiver to the DIGITAL AUDIO OUT (optical or coaxial) on the DVD-VCR back panel.

- 1 **Open "SETUP MENU"**  
With the DVD in stop mode, press the SETUP button.
- 2 **Select "DVD"**  
Using the up/down and left/right buttons, move the selection cursor to "DVD Setup," then press ENTER to select.
- 3 **Select "Audio Options"**  
Move the selection bar to "Audio Options," then press ENTER to select.
- 4 **Set "DTS"**  
Move the selection bar to "DTS," then press right to select from the following options:
  - off - To use your DVD/TV with an A/V receiver NOT equipped with a DTS decoder.
  - on - To use your DVD/TV with an A/V receiver equipped with a DTS decoder.

## Dynamic Compression

*Dynamic Compression constrains the dynamic range, i.e. the difference between the quietest and loudest passages of a DVD soundtrack. This enables you to limit loud noises, such as explosions, or raise the volume of quiet passages, such as whispering, while watching a movie. This is convenient for viewing movies late at night.*

- 1 **Open "SETUP MENU"**  
With the DVD in stop mode, press the SETUP button.
- 2 **Select "DVD"**  
Using the up/down and left/right buttons, move the selection cursor to "DVD Setup," then press ENTER to select.
- 3 **Select "Audio Options"**  
Move the selection bar to "Audio Options," then press ENTER to select.
- 4 **Set "Dynamic Compression"**  
Move the selection bar to "Dynamic Compression," then press right to select from the following options:
  - On - The total dynamic range of the DVD soundtrack will be compressed, so quiet passages will be louder and loud passages will be softer.
  - Off - The original dynamic range will be preserved.

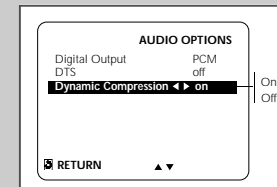
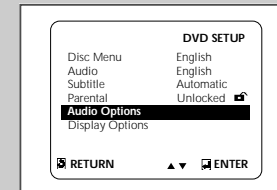
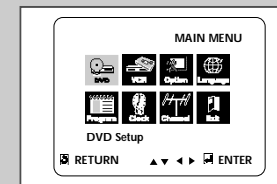

## TV Aspect Ratio

Set the aspect ratio (length x width) of your TV screen so the DVD player will display movies at the appropriate size for your television. Choose from standard, letterbox, or widescreen format.

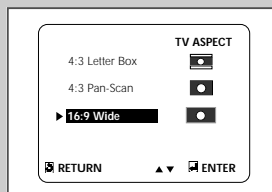
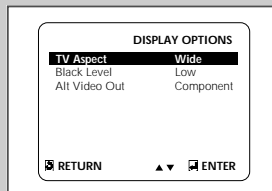
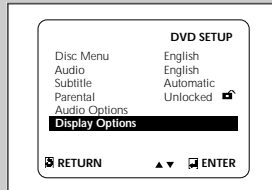
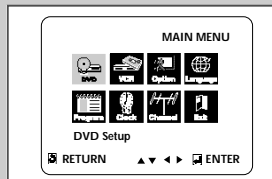

### 1 Open "SETUP MENU"

With the DVD in stop mode, press the SETUP button.

### 2 Select "DVD"

Using the up/down and left/right buttons, move the selection cursor to "DVD Setup," then press ENTER to select.

### 3 Set "Display Options"

Move the selection bar to "Display Options", then press ENTER to select.

### 4 Set "TV Aspect"

Move the selection arrow to "TV Aspect", then press ENTER to select from the following options:

- 4:3 Letterbox – This method displays the full width of the widescreen movie on a standard 4:3 television. As a result, black bars will appear at the top and bottom of the screen.
- 4:3 Pan-Scan – The familiar way of watching DVD and VHS movies, this method selectively crops (by panning and scanning) to keep the most important part of the picture visible) wide screen movies to fit a standard 4:3 television screen.
- 16:9 Widescreen – This method allows you to view the full 16:9 picture on a widescreen television.

## Black Level

The Black Level feature adjusts the reference level of black in the video signal to one of two choices:

- **Low** - Standard NTSC black level. Yields consistent contrast through all sources.
- **High** - Enhanced black level, for increased contrast during DVD playback.

### 1 Open "SETUP MENU"

With the DVD in stop mode, press the SETUP button.

### 2 Select "DVD"

Using the up/down and left/right buttons, move the selection cursor to "DVD Setup," then press ENTER to select.

### 3 Set "Display Options"

Move the selection bar to "Display Options", then press ENTER to select.

### 4 Set "Black Level"

Move the selection bar to "Black Level," then press right to select from the following options:

- **Low** - Standard NTSC reference Black Level for consistent brightness/contrast across all sources.
- **High** - Enhanced Black Level for increased brightness/contrast when viewing DVDs.

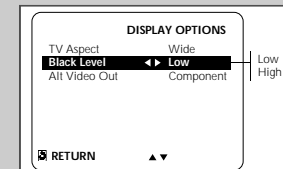
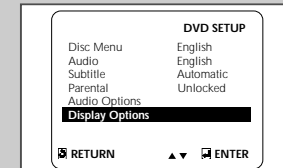
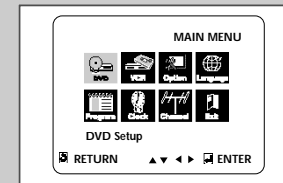

## Alt Video Out

If you connected your DVD-VCR to your television using the S-VIDEO OUT or COMPONENT VIDEO OUT jacks, you MUST set the "Alt (alternative) Video Out" selection in the on-screen menu system.

- The S-Video or Component Video connection is only for the DVD player. The tuner and VCR will still be viewed through the RF or line outputs.

### 1 Open "SETUP MENU"

With the DVD in stop mode, press the SETUP button.

### 2 Select "DVD"

Using the up/down and left/right buttons, move the selection cursor to "DVD Setup," then press ENTER to select.

### 3 Set "Display Options"

Move the selection bar to "Display Options", then press ENTER to select.

### 4 Select "Alt Video Out"

Move the selection bar to "Alt Video Out," then press right to select from the following options:

- **S-Video** – Indicates that you are using the S-VIDEO OUT jack on the rear panel to connect to your TV.
- **Component** – Indicates that you are using the COMPONENT VIDEO OUT jacks on the rear panel to connect to your TV.

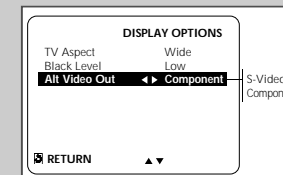
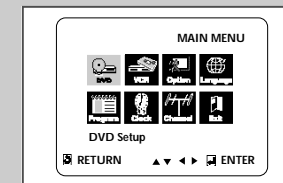

## A/V Receiver Connections

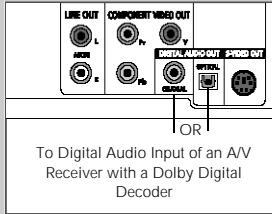

To take full advantage of the movie theater experience that DVD offers, you may want to connect your DVD-VCR to a complete Surround Sound system, including an A/V Receiver and six Surround Sound speakers.

Before You Begin...

- If your A/V receiver is equipped with a Dolby Digital Decoder, you have the option to bypass the DVD-VCR's built-in Dolby Digital Decoder. Use the DIGITAL AUDIO OUT connection below.

### 1 Digital Audio Out

Connect EITHER an optical cable OR a digital coaxial cable from the DIGITAL AUDIO OUTjacks on the back panel of the DVD-VCR to their corresponding Digital Audio Input jacks on your A/V Receiver:

- Optical
- Coaxial
- Use whichever connection is available on your A/V Receiver.

## Special Playback Features

During DVD/CD playback you can select from the following special playback options. To resume normal playback, press the ►|| (Play/Pause) button.

### 1 Still

Press the ►|| (Play/Pause) button on the remote control during playback.

- The picture will pause and the audio will mute.
- To resume playback, press the ►|| (Play/Pause) button.
- If the player is left in Pause mode for 5 minutes, it will stop automatically.

### 2 Frame Advance (Step)

While in Still mode, press the F.ADV/STEP button on the remote control to advance one frame at a time.

- Audio is muted during Frame Advance mode.
  - Press ►|| (Play/Pause) to resume normal playback.
- NOTE: Frame Advance operates only in the forward direction.

### 3 Skip Forward/Back

While a CD or DVD disc is in Play mode, press the Skip Forward/Back (►|◀) buttons on the remote control or front panel to jump forward and backward through disc chapters/tracks.

- Skip Forward will jump to the next chapter/track.
- Skip Back will jump to the beginning of the current chapter/track.
- Press Skip Back again to jump to the beginning of the previous chapter/track.

### Search Forward/Back

While a disc is in Play mode, press and hold the Forward/Back (►|◀) buttons on the remote control or front panel to visually search forward/backward at 2X - 4X - 8X - 16X - 32X - 128X speed. Press ►|| (Play/Pause) button to resume normal speed.

### 4 Slow Motion

During playback, press the ►|| (Play/Pause) button to Still the image. Then use the Search Forward (►|) to play in slow motion at variable speeds.

- Each press increases the slow motion speed playback to 1/8, 1/4 or 1/2 normal speed.
- Audio is muted during slow motion playback.
- Front Panel Slow Motion Buttons - Press and hold the Forward buttons on the front panel to activate slow motion playback. Press the ►|| (Play/Pause) button to resume normal playback.

### 5 Stop/Resume

- Press the Stop button once to stop playback. To resume the DVD/CD from the point where the disc stopped, press the ►|| (Play/Pause) button.
- Press the ■ (Stop) button twice to completely stop playback. The next time you press ►|| (Play/Pause), the disc will start over from the beginning.

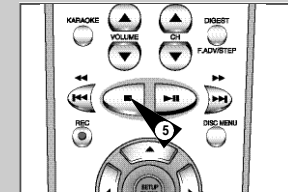
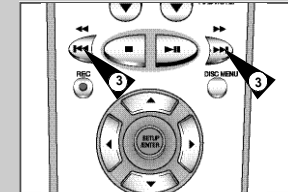
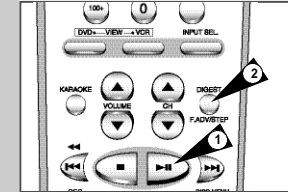



## Disc Menu Navigation

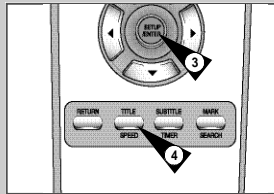
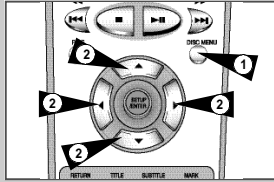

Many DVDs feature their own menu systems, where you can select Titles, Chapters, Audio Tracks, Subtitles, and special disc features, such as movie trailers, and information on the cast. Use these buttons to make selections in the Disc menus.

- 1 **DISC MENU** Button  
Press to access the DVD's Disc menu, if applicable.
- 2 Press ▲, ▼, or ◀, ▶ to navigate through DVD's Disc menu options.
  - Press up, down, left and right to highlight menu choices.
- 3 **ENTER** Button  
Press to make your selections in the Disc menu.
- 4 **TITLE** Button  
Press to access the DVD's Title menu, if applicable.

## Screen Fit Playback



- 1 **SCREEN FIT** Button  
During play, press SCREEN FIT button on the remote control.
    - Allows you to eliminate the black bars in the top and bottom of the screen when a movie is playing in the Widescreen format (16:9).
    - Screen Fit will not work when the Zoom mode is active. (you can not remove the black bars on the screen) However, Zoom mode will work when Screen Fit is active.
- 
- ◆ Various aspect ratios are available only in multiple screen format discs.
  - ◆ This function does not work when a DVD has been recorded in a multi-camera angle format.
  - ◆ On some DVDs, the black bars cannot be eliminated due to their aspect ratio.

## Title/Chapter/Time Selection

If you press the DISPLAY button during DVD playback, you can view the current Title, Chapter/Track, and counter position. You can also use this screen as shortcut to select any Title, Chapter/Track, or counter position on the disc.

- 1 **View DVD/CD Display**  
Press the DISPLAY button on the remote control during DVD/CD playback.
- 2 **Select Title**  
Press the up/down and left/right buttons to select Title, then press ENTER to change among all available titles on the disc.
  - The "TITLE" icon will light on the Front Panel Display, followed by the current title number, hours, minutes, and seconds.
- 3 **Select Chapter or Track**  
Press the up/down and left/right buttons to select Chapter or Track, then press ENTER to change among all available Chapters/Tracks on the disc.
  - The "CHAP" icon will light on the Front Panel Display, followed by the current title number, hours, minutes, and seconds.
- 4 **Select Counter Position**  
Press the up/down and left/right buttons to select the counter position indicator, then use the number buttons (0-9) to enter the desired counter position in the format HH:MM:SS (H = Hours, M = Minutes, S = Seconds).  
Then press ENTER to enter the desired counter position.

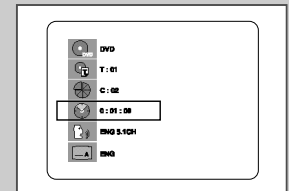
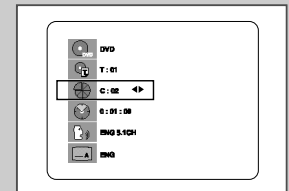
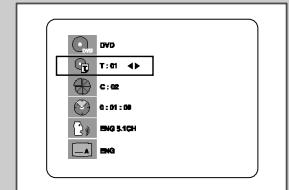
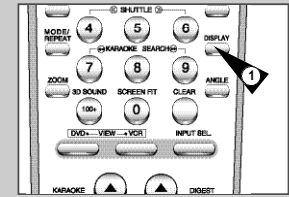

## Zoom

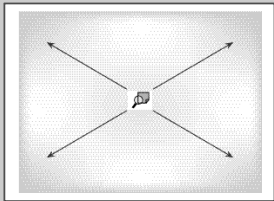

You can zoom in at 2 or 4 times the normal magnification while watching a DVD.

- 1 Open Zoom Magnifying Glass**  
During Playback or STILL mode, press the ZOOM button to display the "Magnifying Glass icon" on the screen.
- 2 Position Magnifying Glass**  
Use the ▲, ▼, ◀, ▶ buttons to move the magnifying glass to any position on the screen you want to zoom.
- 3 Zoom In**  
Press the ENTER button repeatedly to zoom in at 2X - 4X - 2X - and normal magnification.

## Angle

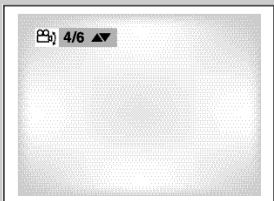

Some DVDs allow you to view the same scene from different perspectives, or angles, while watching a movie. Press the ANGLE button to activate this feature.

- 1 Check for Angle Marker**  
If multiple Angles are available on the DVD, the Angle mark will appear on the screen during playback.
- 2 View Angle Options**  
If the Angle mark is present, press the ANGLE button to view the Angle Selection menu.
- 3 Select Screen Angle**  
Press the up/down buttons to select one of the available screen angles.

## Subtitle

Many DVDs provide subtitles in one or more languages. The SUBTITLE button provides a shortcut to view and select these options.

- 1 Open Subtitle Menu**  
During playback, press the SUBTITLE button.
- 2 Set Subtitle Language**  
Press the up/down buttons to select among all available subtitle languages.
  - Subtitle languages are often represented by abbreviations.
- 3 Activate Subtitles**  
Press the left/right buttons to turn subtitles On or Off.
  - The default subtitle setting is Off.
  - Press the ENTER button to confirm your selection.

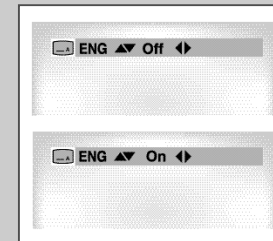
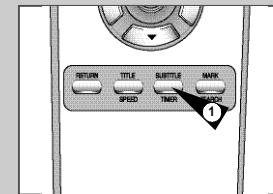

## Digest Playback

- 1 DIGEST Button**  
During playback, press the DIGEST button.
  - You'll see the 9 individual windows representing each of the chapters on the TV screen.
  - When each window is displayed, the first 3 seconds of the chapter will be played.
- 2 Set DIGEST**  
Press the up/down buttons and left/right buttons or NUMBER button to select the window you'd like to see, and press ENTER.
  - Up to 9 windows(chapters) can be displayed on the screen at a time. Press ▶ for the next 9 chapters if the movie has more than 9.



- ◆ You can start playback of the DVD player from the desired chapter.
- ◆ 'DIGEST' may not operate depending on the disc in use.

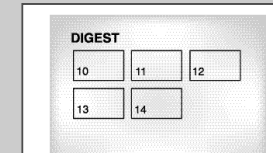
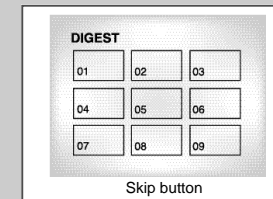
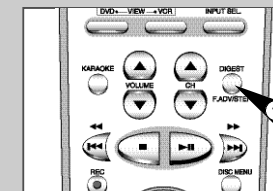

## A-B Repeat

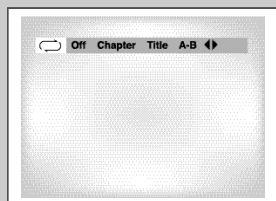

*The A-B Repeat function allows you to repeat any segment of a DVD or CD. Simply mark the beginning point (A) and the ending point (B) of the segment you want to review.*

### 1 Select A-B Repeat Function

In Play mode, press the REPEAT button, then press left/right to select A-B Repeat.

- "A-" will highlight when A-B Repeat is selected.

NOTE: If you are playing a CD, the menu will display "Track" in place of "Chapter"

### 2 Mark the Starting Point

Press the ENTER button at the beginning of the segment you want to repeat (Point A).

- "B" will highlight after Point A is selected.

NOTE: The minimum AB Repeat time is 5 seconds.

### 3 Mark the Ending Point

Press the ENTER button again at the end of the segment you want to repeat (Point B).

- The segment will begin repeating in a continuous loop.

### 4 Cancel A-B Repeat

Press the REPEAT button to open the Repeat Menu, press left/right to highlight "Off," then press the ENTER button.

## Repeat Chapter/Title

*You can repeat a single chapter, or repeat a complete title.*

### 1 Open Repeat Menu

In Play mode, press the REPEAT button to open the Repeat menu.

- The current Repeat Mode will be highlighted.

### 2 Select "Chapter"

Press the left/right buttons to select "Chapter".

- "Chapter" will highlight when Chapter Repeat is selected.

### 3 Repeat Chapter

Press the ENTER button to repeat the current chapter/track.

### 4 Select "Title"

Press the left/right buttons to select "Title".

- "Title" will highlight when Title Repeat is selected.

### 5 Repeat Title

Press the ENTER button to repeat the title.

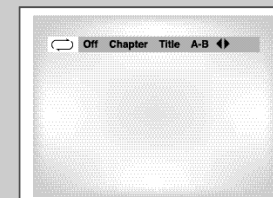
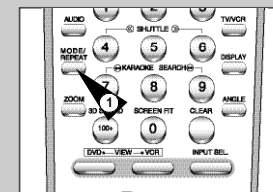

## Audio

*Many DVDs provide multiple language and audio setup options, such as Dolby Digital 5.1, Dolby Pro Logic, or LPCM 2 Channel audio. The AUDIO button provides a shortcut to view and select among all available options for a given disc.*

### 1 Open the Audio Menu

During playback, press the AUDIO button on the remote control.

### 2 Select DVD Audio Track

Press the up/down buttons to select the desired language/audio setup on the DVD.

- Languages are represented by abbreviations; i.e. "ESP" for "español."

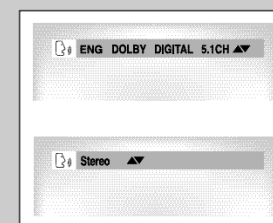

## Bookmarks

*You can insert up to three Bookmarks on your DVDs, so you can jump quickly to your favorite scene or song.*

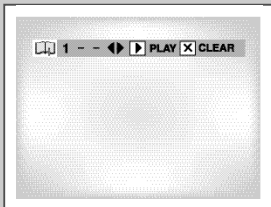
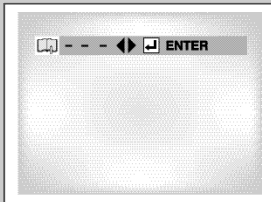
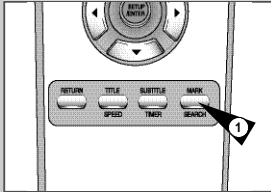

### 1 Open Bookmark Menu

During playback, press the MARK button on the remote control. The "Mark" header will appear on the screen.

### 2 Select Bookmark Placeholder

Press the left/right buttons to move to one of the three bookmark placeholders (- - -).

- The selected placeholder will highlight.

### 3 Set the Bookmark

Play the DVD to the scene you want to bookmark, then press the ENTER button. The placeholder will change to a number (1, 2 or 3).

- You can continue setting up to three bookmarks.
- When finished, press the MARK button to exit.
- Depending on the disc, the bookmark function may not work.

### 4 Play Bookmark

- During playback, press the MARK button on the remote control.
- Press the left/right buttons to move to a previously set bookmark.
- Press the Play/Pause button to play the bookmark.
- Press the CLEAR button to cancel the bookmark.
- Press the MARK button again to exit the Bookmark menu.

## Programmed Playback

*Programmed Playback lets you set a custom order for playback of chapters/tracks on a DVD or CD.*

### 1 Open Playback Mode Menu

While in Stop mode, press the MODE button.

### 2 Select "PROGRAM"

Using the left/right buttons, move the selection bar to "PROGRAM" then press ENTER to select.

### 3 Select Chapter/Track

Press the up/down and left/right buttons to select the first chapter/track in your revised playback list, then press the ENTER button.

### 4 Program Playback Order

Use the up/down and left/right buttons to select the remaining chapters/tracks, pressing Enter after each.

- Press the CLEAR button to change selections.

### 5 Play Revised Order

Press the ►|| (Play/Pause) button. The disc will play back in the custom programmed order.

- While in playback mode, press the CLEAR button on the remote control to cancel Programmed Play.

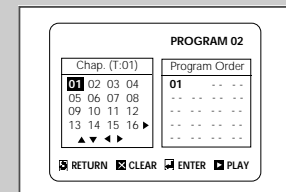
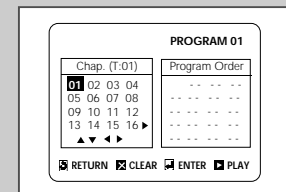
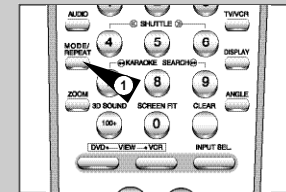

## Random Playback

*DVD Random Playback lets the DVD-VCR set a random order for playback of chapters/tracks on a DVD or CD.*

### 1 Open Playback Mode Menu

In Stop mode, press the MODE button.

### 2 Select "RANDOM"

Using the left/right buttons, move the selection arrow to "Random Play," then press ENTER to select.

- The disc will playback automatically in random order.

### 3 Cancel Random Play

Press the CLEAR button on the remote control to cancel Random Play.

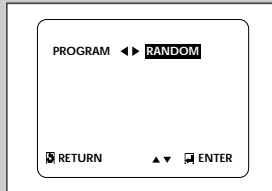

## MP3 Playback

*MP3 is a popular music format which allows you to compress music files up to 1/12 of their original size while retaining near CD quality sound. Your DVD-VCR can playback MP3 files burned onto a CD-R disc.*

### 1 Insert Disc

Insert a CD-R with MP3 files into the DVD deck.

- The MP3 main menu will appear after a few seconds and the first song on the disc will begin playing.

### 2 Select Folder

Press the up/down buttons to select the folder on the CD-R which contains the MP3 files you want to hear, then press Enter to select.

- If there are more than 8 folders on the disc, press RETURN to view additional folders.
- If there are no folders on the CD-R, skip to Step 3.

### 3 Select MP3 File

Press the up/down buttons to select the desired MP3 file.

- If there are more than 8 MP3 files in the selected folder, press the left/right buttons to view additional MP3 files.
- File names are truncated to eight characters: the first six characters of the song, plus an asterisk (\*), then a number.
- Press the Return button to back up and select another folder.

### 4 Play MP3 File

Press the ENTER button on the remote control to play the selected song.

- While the song is playing, you can use the up/down buttons to browse through other folders.

### 5 Stop MP3 Selection

Press the ■ (Stop) button on the remote control to stop playback.

\* To ensure proper playback of discs burned from MP3 files, make sure the files have been recorded at a bit rate of at least 128 kbps.

\* If there are any gaps (blank data) on multi-session discs, you may experience playback problems.

\* On discs that are recorded with a Variable Bit Rate (VBR), e.g. from 32 to 320 kbps, the sound may cut in and out.

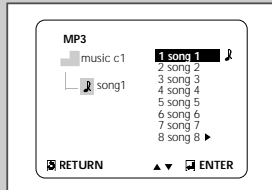
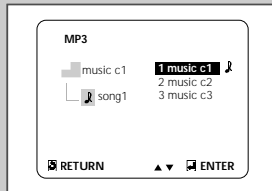

## 3D Sound

*3D Audio is an enhanced audio mode that creates the illusion of Surround Sound with only two speakers.*

### 1 Open 3D Sound Menu

During playback of a DVD, press the 3D SOUND button on the remote control.

### 2 Set 3D Sound

Press the up/down buttons to set "3D Sound" On or Off, then press the 3D SOUND button to confirm your selection.

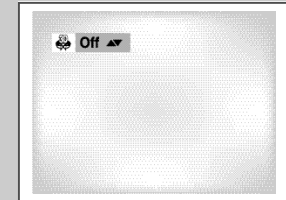
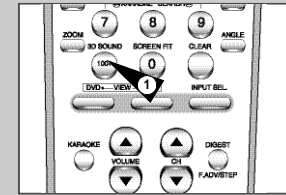

## Special VCR Playback Features

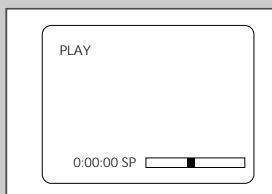

Press the DISPLAY button to see the current status of the VCR deck, as well as the tape counter position and record speed.

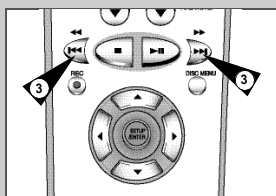

*While a videotape is playing, you can enjoy a variety of special playback features, including Still, Frame Advance, Skip, Repeat, and more. Press the Play button again to resume normal playback.*

- 1 Still**  
From Play mode, press Play/Pause to still a single frame.
- 2 Frame Advance**  
From still mode, press F.ADV/STEP to advance to the next frame.
- 3 Cue/Review**  
From Play mode, press F.Forward (▶▶) or Rewind (◀◀) to cue/review at two speeds:
  - Picture Search — Press and release to advance the tape forward or backward at 5 times normal speed.
  - Jet Search — Press and hold to advance the tape forward or backward at 7 times normal speed.
- 4 Skip**  
From Play mode, press F.ADV/STEP to cue ahead exactly 30 seconds. Press Skip repeatedly up to 4 times to cue ahead 2 minutes.
- 5 Repeat**  
From Play mode, press Repeat to review the last 5 seconds of tape (SP mode).
- 6 Shuttle**  
From Play mode, Shuttle >> gradually increases the cue speed from Double-Speed playback to Picture Search to Jet Search. Shuttle << gradually slows down the tape, then goes into Slow mode, Still mode, Reverse Picture Search and Reverse Jet Search.

## Tracking

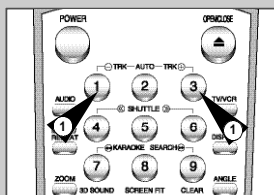

*The Tracking adjustment removes the white lines that sometimes appear during playback because of slight differences in recording decks. The TRK button will automatically align the recorded tracks with the playback heads to solve this problem. You may also set tracking manually.*

- 1 Adjust Tracking Manually**  
During playback, press the TRK (⊕ or ⊖) buttons to move the white lines out of the picture.

## Auto Play

*If you want your videotapes to play automatically when you insert them, turn on Auto Play.*

**NOTE:** Only tapes that are missing the Record Safety Tab will play automatically when inserted.

- 1 Open the "SETUP MENU"**  
With the DVD in stop mode, press the SETUP button.
- 2 Select "VCR"**  
Using the up/down and left/right buttons, move the selection arrow to "VCR Function Setup," then press ENTER to select.
- 3 Select "Auto Play"**  
Move the selection arrow to "Auto Play," then press right to select from the following options:
  - On - The VCR will automatically begin playing a video tape when it is inserted, as long as the safety tab of the cassette has been removed.
  - Off - Auto play is disabled.
- 4 Tape Length**  
Press the left button to select the video cassette length. This information is usually printed on the tape box. The menu cycles through: T120, T160 or T180. Once the type of cassette is set, the VCR can display the amount of time remaining on the tape when you press the DISPLAY button.
- 5 Auto Repeat**  
In the VCR FUNCTION SET UP "Auto Repeat" sets the VCR to play a tape repeatedly [unless a tape control is activated (stop, fast forward or rewind)].

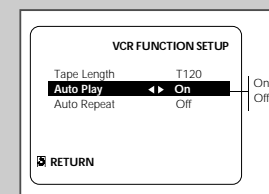
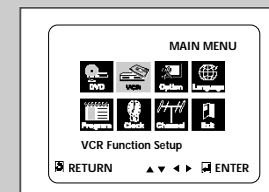
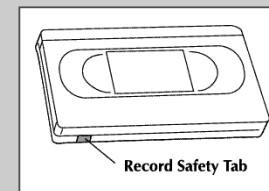

## S-VHS Playback

*The DVD-VCR allows you to playback high quality S-VHS tapes.*

- 1 Insert a S-VHS Tape**  
Insert an S-VHS tape into the VCR deck.
- 2 Start Playback**  
Press Play/Pause on the remote control to begin playback of the S-VHS tape.

## Variable Search System

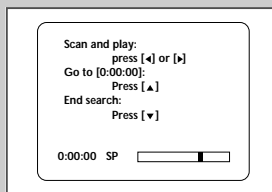

Press the **SEARCH** button to display the search screen in the stop mode. When a program is recorded, the starting point is given an Index mark for easy location. However, the VHS Index Search System (VISS) cannot recognize index marks made by old VCRs. If the VCR has trouble finding a mark, it is probably because the cassette was recorded on a VCR without VISS. If you want to index two programs in a row, set your VCR to stop, then start recording each program. Pause has no effect on index marks.

### 1 Scan and play

Use scan and play when you don't know exactly where a program is located on a cassette tape.

- Press right arrow for forward scan or left arrow for reverse scan.
- The display will show "Scan and Play".
- When an index mark is found, the VCR plays for about five seconds.
- Press the **PLAY** button to view that program.

If you don't press **PLAY**, the VCR automatically searches for the next index, or until the end of the tape is reached.

### 2 Go to 0:00:00 stop

Use this feature when you want to search for the 0:00:00 counter position on a cassette. Press the **CLEAR** button at the point on the tape where you want to set the counter to 0:00:00. Later, while a cassette is stopped, press up arrow button. The VCR will rewind or fast forward, searching for the 0:00:00 counter position, and then automatically stop at that position.

### 3 End search

Use this feature when you want to search for a blank position to record a program on a cassette. While a cassette is stopped, press down arrow button. The VCR will fast forward, searching for a blank position, and then automatically stop at that position. If the VCR reaches the end of the tape during end search, the tape will be ejected.

## Basic Recording

You can record a TV show in progress by inserting a blank tape and pressing the **REC** button. You can even add time in 30-minute increments up to 4 hours by pressing the **REC** button repeatedly; see page 47.

**NOTE:** Be sure your videotape has a Record Safety Tab. If the tab is missing, you can cover the opening with a small piece of tape. Warning: Do not cover this opening unless you are sure you want to record over the tape.

### Before You Begin...

- Power on the DVD-VCR
- Power on the TV
- Set the TV to channel 3 or 4.

### 1 Insert Tape

Insert a blank VHS tape into the VCR deck.

- Make sure the tape is long enough to record the entire program. To change the Recording Speed, see page 47.

### 2 Select a Channel to Record

Use the 0-9 buttons or the Channel Up/Down arrow buttons to select the desired channel, or press the **INPUT SEL.** button to select Line 1.

### 3 Start Recording

Press the **REC** button on the remote control or front panel.

For options while recording is in progress, see "Special Recording Features" on the next page.

➤ Recording from the DVD player to the VCR is not possible.

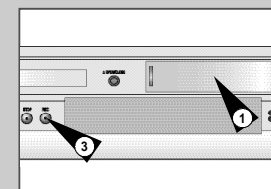
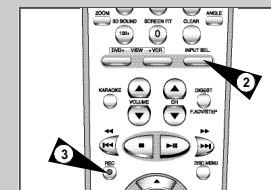
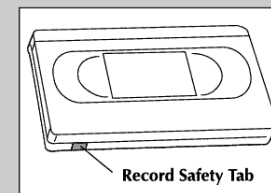

## Special Recording Features

While a recording is in progress, you can watch a different channel, watch a DVD, or add recording time in 30-minute increments.

### 1 Pause/Resume Recording

Press the ►|| (Play/Pause) button. Press REC again to resume.

### 2 Stop Recording

Press the STOP button.

### 3 Watch a Different Channel

Press the TV/VCR button on the remote to switch to your TV tuner, then select a different channel on your television.

### 4 To Watch a DVD

Insert a DVD in the DVD deck and press Play. The output will automatically change to the DVD.

### 5 Add Recording Time

See One-Touch Recording (OTR) on the next page.

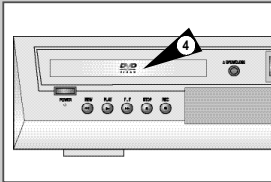
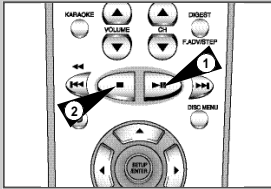

## One-Touch Recording (OTR)

One-Touch Recording (OTR) allows you to add recording time in 30-minute increments up to 4 hours at the touch of a button.

### 1 Start Recording

Follow the instructions on page 45 to begin recording.

### 2 Activate OTR

While in Record mode, press the REC button again to activate One-Touch Recording (OTR).

- Record length 0:30 appears on the On-Screen Display and the DVD-VCR will record for exactly 30 minutes.

### 3 Add Recording Time

Continue pressing REC to add recording time in 30 minute increments up to 4 hours.

- The DVD-VCR stops recording automatically when the time has elapsed.

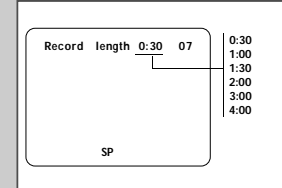
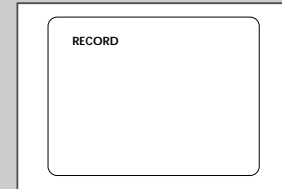

## Record Speed

You can slow down the recording speed from SP to SLP in order to fit six hours of programming on a T-120 tape.

### 1 Start Recording

Follow the Basic Recording instructions on page 45.

### 2 Set Record Speed

Press the SPEED button on the remote control to set the Record Speed to one of the following options:

- SP – Standard Play, for best quality.
- SLP – Super Long Play, for maximum recording time (3 times SP).

NOTE: The selected Record Speed will appear on the front panel display and on-screen display.

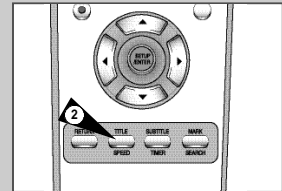

### Maximum Recording Time - SP vs. SLP

Tape Length	SP (Standard Play)	SLP (Super Long Play)
T-120	2 hrs	6 hrs
T-160	2hrs 40 mins	8 hrs
T-180	3 hrs	9 hrs



## How to Set a Timer Recording

*Insert a blank tape with a Record Safety Tab into the VCR deck.  
The Timer Recording Feature allows you to program up to 8 events  
at a time to record up to a month in advance.  
Set the TV to channel 3 or 4.*

*Before You Begin...*

- Power on the DVD-VCR
- Power on the TV

### 1 Open "SETUP MENU"

With the DVD in stop mode, press the SETUP button or press the TIMER button.

### 2 Select "Program"

Using the up/down and left/right buttons, move the selection cursor to "Set Timer Recording," then press ENTER to select.

### 3 Select Channel Number

Press right and up/down buttons to set the channel. Press the right button to move to the next setting.

### 4 Set "Time/Date/Speed"

Repeat step 3 to set start time, end time, date and record speed. Date can be set for one time, daily or weekly recording. See below.

### 5 Save "Timer Recording"

Press the RETURN button to complete programming of the timer recording. Stop the VCR or turn the power off. The timer indicator comes on the VCR. The VCR will automatically turn on and begin recording at the time you set. To stop a timer recording, press the POWER button or STOP button on the VCR.

### 6 Auto Speed Select

If you are not sure the tape is long enough for timer program recording in the SP tape speed, set the recording tape speed to "AUTO". Recording starts in the SP tape speed. If the tape length is not long enough, the tape speed automatically changes from SP to SLP.

### 7 Daily/Weekly Date Programming

Weekly [SUN'S-SAT'S]: You can record TV programs on the same channel at the same time every week.

Daily [MO ► FR] : You can record TV programs on the same channel at the same time every day Monday through Friday.

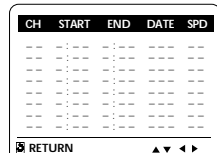
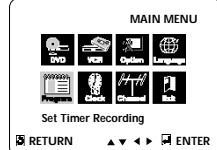

## Using the KARAOKE Function (VCR)

- 1 Press the POWER button and insert KARAOKE tape.
- 2 Connect Mic into MIC1 or MIC2 jack. Then the KARAOKE mode is transferred "ON" mode.
  - ◆ Disconnect the Mic makes the KARAOKE mode transfer to "OFF" mode automatically.
  - ◆ Press the KARAOKE button on the remote control. Press the ◀ or ▶ button to select KARAOKE mode "ON".
- 3 To adjust the Mic volume and ECHO level, press the VOLUME and ECHO ▲ or ▼ keys front panel.
- 4 To sing with accompaniment.

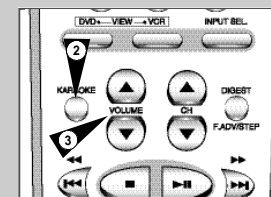

## SCORE Function

- 1 Press the KARAOKE button on the remote control.
- 2 Press the corresponding ▲ or ▼ buttons to select the SCORE mode.
- 3 Press the ◀ or ▶ buttons to select the SCORE mode "ON".
- 4 Score will pop up whenever a song is completed.

KARAOKE : ON ◀▶  
▶ SCORE : ON ◀▶

## KARAOKE SEARCH Function

- 1 Press the POWER button and insert KARAOKE tape.
- 2 Press the KARAOKE button to turn the KARAOKE mode ON.
- 3 Press ►|| to start playing the cassette.
- 4 When you want the next song during playing a song, press the KARAOKE SEARCH ►► or KARAOKE SEARCH ◀◀ buttons on the remote control.

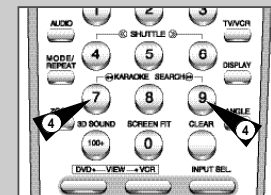

## Beginning Karaoke Functions (DVD)

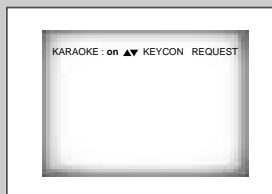

- 1 Connect the Mixed Audio Out terminals with the TV or AMP.
- 2 Press the power button.
- 3 Connect Mic into Mic 1 or Mic 2 jack. Then the karaoke mode is transferred to ON mode.  
- To disconnect the Mic makes the karaoke mode transfer to OFF mode automatically.

## Key Control



- 1 Pressing the KARAOKE button makes the karaoke ON mode.
- 2 Select the "KEYCON" using the ◀ or ▶ buttons.
- 3 By use of the ◀ or ▶ buttons, change to the desired tone.  
- ♭ : To let 7 scales down by half scale.  
- ♮ : Original scale.  
- # : To let 7 scales up by half scale.

- ◆ Key control function is not applied to the Mic output.
- ◆ Key control function can not work at the VCR

## Reserving a Song

*It is the function to reserve the desired song in advance by use of Karaoke function.*

- 1 Playback the Karaoke Disc containing the wanted songs.
- 2 After pressing the KARAOKE button of the remote transfer to the KARAOKEON mode using the ▲ or ▼ buttons.
- 3 Select the "REQUEST" using the ◀ or ▶ buttons, then press ENTER button.
- 4 Input the number (Track No.) of the desired song into the flickering part(-).  
- You can reserve up to 10 songs.
- 5 When you want the next reserved song during playing a song, press the ▶▶ button.

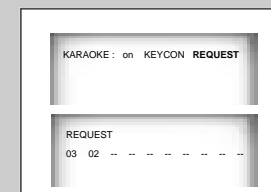

## Cancellation of reservation

- 1 Cancel by pressing the CLEAR button of the remote.  
- The last reserved song will be erased first.
- 2 Continuous pressing of the CLEAR button can cancel the next reserved song.
- 3 If the reservation is required again, input the song number in the flickering part.

- ◆ Request function is available only when the Karaoke mode is "ON".
- ◆ When using "▶▶" button, it can not work at the last song.
- ◆ When using Request function, the "REPEAT" function does not work.
- ◆ If the CLEAR button is pressed when the Request message is not shown on the screen, all the songs on your playlist will be cleared.

## Vocal Fader

Pressing the **KARAOKE** button twice displays the following in Karaoke **ON** mode:

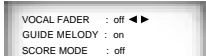

VOCAL FADER : off  
GUIDE MELODY : on  
SCORE MODE : off

- The function to make the music only sound by cancelling vocal when playing a Karaoke disc.

VOCAL FADER	Remark
V1	CH1. Vocal Cancel
V2	CH2. Vocal Cancel
V1 +V2	CH1, CH2. Vocal Cancel
OFF	Vocal Fader Off

- In VCD, CVD or CD, you can select only the L, R, OFF.

## Guide Melody

- ◆ To guide melody through xylophone and piano help you sing easily.
- ◆ This function works only on the DVD Karaoke disc on which the guide melody is recorded.

## Score Function

- Press **KARAOKE** button twice to turn the Score Mode On.
- ◆ Score will pop up whenever a song is completed.

## Types of Karaoke disc

### ◆ DVD Karaoke Disc

Channel	Karaoke -Channel	5CH. DVD	2CH. DVD
1 CH	L	Left stereo music	Left stereo music + Vocal
2 CH	R	Right stereo music	Right stereo music + Vocal
3 CH	M	Guide melody	-
4 CH	V1	Vocal track	-
5 CH	V2	Vocal track	-

### ◆ CVD, VCD Karaoke Disc

Channel	Karaoke -Channel	CVD	VCD, CD
1 CH	CH1 LEFT	Left stereo music+Vocal	Left stereo music
1 CH	CH1 RIGHT	Right stereo music+Vocal	Right stereo music + Vocal
2 CH	CH2 LEFT	Left stereo music	-
2 CH	CH2 RIGHT	Right stereo music	-

**CAUTIONS:** Make sure to turn the **KARAOKE MODE** to OFF to play a movie disc or play in a general mode. If you play a movie disc with the **KARAOKE ON**, a score will show up every time when a chapter is over.

## S-Video/Component Video Connections (for DVD)

The **S-Video** or **Component Video** connection is only for the DVD player. The tuner and VCR will still be viewed through the **RF** or **line inputs**.

You must follow the "Alt Video Out" instructions on page 31 to activate your alternative (**S-Video**, **Component**) video selection. You can choose **EITHER S-Video OR Component**, but **NOT both**. If your television is equipped with **S-Video** or **Component Video** inputs, you can enjoy superior video quality when watching DVDs with your **DVD-VCR**.

### 1 Connect S-VIDEO OUT to TV

Connect an S-Video cable from the **S-VIDEO OUT** on the back panel of the DVD-VCR to the S-Video Input on your television.

### 2 Connect Component Video Out to TV

Connect a component video cable from the **COMPONENT VIDEO OUT** (Y, Pb, Pr) on the back panel of the DVD-VCR to the Component Video Input on your television.

### 3 Connect Audio Out (DVD only)

Connect RCA audio cables from the Left/Right Line Out jacks on the back panel of the DVD/VCR to the Left/Right Audio Line In jacks on your television.

- You must use these Line Out jacks when connecting the DVD-VCR to your TV with the S-Video or Component Video output.
- Please refer to "Alt Video Out" on page 29 to activate your connection.



To S-Video Input on Your TV

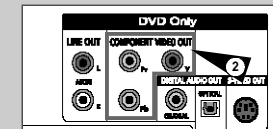

To Component Video Input on Your TV

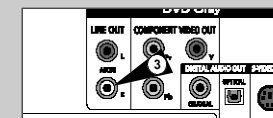

To Left/Right Audio Inputs on Your TV

## Stereo Connections

*You can enjoy stereo sound when watching movies and TV shows by connecting your DVD-VCR to your home stereo system or stereo TV.*

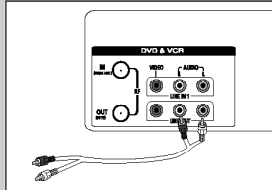

### 1 Connect DVD-VCR to Stereo

Connect RCA cables from the Line Out Left & Right Audio jacks on the back panel of the DVD-VCR to the Auxiliary Inputs on your stereo receiver. If you are using a stereo television, connect the Video Output as well.

### 2 Set Stereo to Auxiliary Mode

Set your stereo receiver or television to "Aux" or "Tape," whichever selects the line input for your particular device.

### 3 Play a Tape

Insert a DVD or Hi-Fi stereo videotape in your system and adjust the volume on your stereo receiver or television. You should hear the audio through your stereo speakers.

- If you still do not hear stereo sound after inserting Hi-Fi stereo video tape, press the Audio button until "Hi-Fi" appears on the on-screen display.

## Monitor TV Connections

*Monitor-style televisions offer improved sound and picture over regular televisions because they receive the audio and video signals directly from the DVD-VCR through the line inputs.*

**NOTE:** A monitor television is not the same as a computer monitor.

### 1 Connect VCR to Monitor TV

Connect RCA cables from the Audio/Video Line Out jacks on the back panel of the DVD-VCR to the Audio/Video Line Inputs of your monitor TV.

### 2 Set TV to Auxiliary Mode

Set your monitor TV to "Aux," "Video," or "Line." Refer to your monitor television owner's manual for the correct setting.

### 3 Connection is Complete

**NOTE:** With this connection, the TV/VCR button has no effect. It is as if the TV/VCR button were always set to VCR.

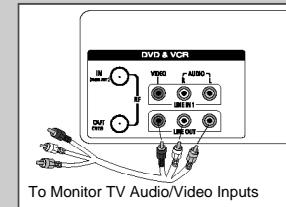

To Monitor TV Audio/Video Inputs

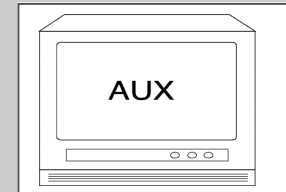

## Connecting Other Video Equipment

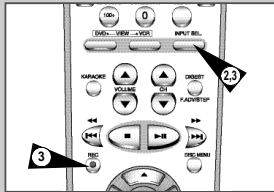
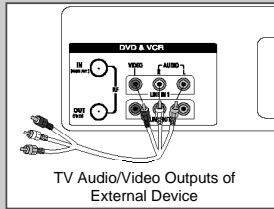

You can connect a wide variety of audio/video equipment to your DVD-VCR, including:

- An additional VCR
- Laser Disc Player
- DVD Player
- Camcorder
- Satellite Receiver
- Video Game

Since all of these devices use essentially the same connections, they will be described together.

### 1 Connect Device to DVD-VCR

Connect RCA cables from the Audio and Video Line Outputs of your external device to the Audio and Video Line Inputs on the back panel of the DVD-VCR.

### 2 Watch Device

Play your external device, then press the Input Sel. button until the playback from LINE1 (rear panel inputs) appears on your TV screen.

### 3 Record Device

First, play your external device. Next, press the Input Sel. button until the playback from LINE1 (rear panel inputs) appears on your TV screen. Then press Record on the VCR deck.

### 4 Timer Record From Device

Select LINE1 (L1) as your record source in the Timer Record menu. All other Timer Record settings should be set in the usual manner.

## Technical Specifications

<b>Inputs</b>	AUDIO	Stereo audio input, RCA Connector, -8dbm, 47K , front and rear	
	VIDEO	Composite video input, RCA Connector, 75 , 1Vp-p	
	RF	Antenna or CATV Input, F-Connector, 75	
<b>Outputs</b>	AUDIO	1 Stereo audio outputs, RCA Connector, -8dbm, 1.5K	
	AUDIO (DVD only)	2 Digital audio outputs (1 optical, 1 coaxial) 1 Stereo audio outputs	
	VIDEO	1 Composite video output, RCA Connector, 75 , 1Vp-p	
	VIDEO (DVD only)	1 S-Video output, S-Connector, 75 , Y=1.0Vp-p, C=0.286Vp-p 1 Component video output, 75 , Y=1.0Vp-p, Pb=0.7Vp-p, Pr=0.7Vp-p	
<b>VCR</b>	RF	Channel 3 or 4	
	VIDEO SYSTEM	1/2-inch VHS system, 4 rotary head helical scanning; FM azimuth luminance;chrominance: converted sub system phase shift	
	AUDIO TRACK	Normal: 1 track; Hi-Fi: 2 track	
	PLAY/RECORD TIME	T-180 tape: SP 3 hours, SLP 9 hours	
	FF/REW TIME	T-120 tape: <2 minutes	
	HEADS	Video: DA 4 rotary Audio: 2 rotary heads (Hi-Fi); 1 stationary head (Linear) Control:1 stationary head Erase: 1 full track, 1 audio track	
	WOW & FLUTTER	Less than 0.005% (Hi-Fi)	
	FREQ. RESPONSE	20-20,000 Hz (Hi-Fi)	
	<b>DVD</b>	DISC COMPATIBILITY	CD, CD-R, CD-R/W DVD-Video, CD-Digital Audio (5" and 3.5"), CD-Video, MP3 files on CD-ROM
		FREQ. RESPONSE	96/48 kHz Sampling: 4 Hz-22kHz
S/N RATIO		110 dB	
DYNAMIC RANGE		96 dB	
THD	0.003 %		
<b>SYSTEM</b>	POWER REQUIREMENT	100-240V AC, 50/60 Hz, 29 watts	
	ENVIRONMENT	41-104 F (5-40 C); 10%-75% humidity	
	WEIGHT	13.8 lbs.	



AK68-00091A